

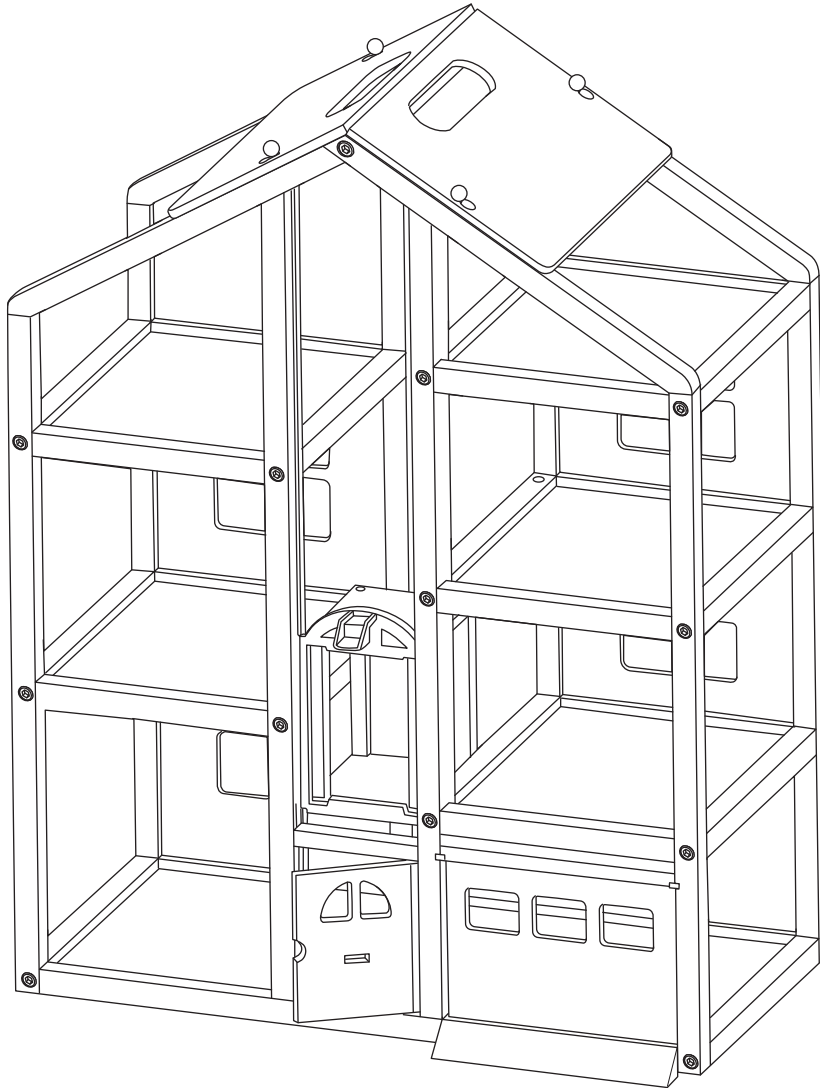

Hi-Rise Dollhouse

ASSEMBLY INSTRUCTIONS

Put Together in 7 Steps!



Have a question or need help? Give us a call! 1-800-284-3948

Item #2462

We care about your comments. Please call us!

Melissa & Doug
1-800-284-3948
www.MelissaAndDoug.com

Melissa & Doug products meet or exceed U.S. testing standards and pass our high quality requirements.
© Melissa & Doug, LLC, P.O. Box 590, Westport, CT 06881
MADE IN CHINA

WARNING:
CHOKING HAZARD - Small Parts.
Not for children under 3 years.

CAUTION:
ADULT ASSEMBLY REQUIRED.

Ages 3+

THANK YOU!

Thank you for choosing the Melissa & Doug Hi-Rise Dollhouse! It's a terrific way to help nurture a child's creativity and imagination, and to inspire story-telling and independent play for years to come.

NOW IT'S TIME TO PUT IT TOGETHER!

Don't worry, assembling your new dollhouse is simple, and we're here to help. It may go a little faster with a partner to lend a hand, but we've made it so one person can assemble the dollhouse. Here are a few tips before you begin:

- Read through all the instructions first.
- Clear a flat, covered space (carpeted is best) to lay out all the materials so everything is close at hand.
- You will need a Phillips head screwdriver (not included) to assemble the dollhouse. We've included everything else you will need. All parts are labeled with a sticker (A-P).
- The instructions include lots of helpful pictures—we show you, step-by-step, exactly how to align pieces and parts for speedy and accurate assembly. Note that hardware needed for each step is shown in the upper right corner of the page, each piece being added in a given step is highlighted in gray, and the “assembled view” (what it looks like when the step is completed) is included in the lower right corner of every page.
- In the instructions, the name of a part is followed by a letter in parentheses. This letter corresponds to the sticker on the part, as well as the picture of the part shown on page 2.
- Helpful hints are highlighted with a large exclamation point.



IMPORTANT: Helpful hints are found here.

- Do not over tighten screws and bolts during assembly. Screws and bolts should be fully tightened once the entire assembly is complete.
 - If you have any questions, we're here for you! Give our customer care team a call at 1-800-284-3948!
-

WARNINGS!

Retain these instructions for future reference.

Warning: Prevent Tip Overs!

- Do not allow children to pull, climb, sit, or stand on any part of the dollhouse..
 - The dollhouse must be placed on a hard, flat, and level surface.
 - For more information on how to prevent furniture tip overs in your home visit AnchorIt.gov.
 - The dollhouse must be assembled as instructed.
-

MAINTENANCE:

Ensure the dollhouse continues to function properly and safely by regularly checking the hardware and tightening when necessary.

PARTS - Be Smart—Sort Your Parts

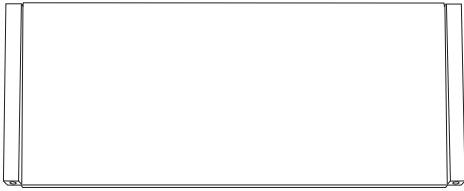

A base

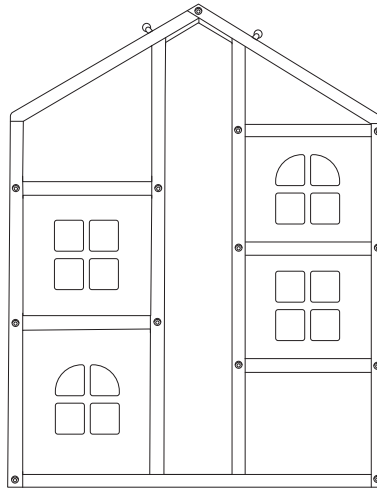

B rear wall

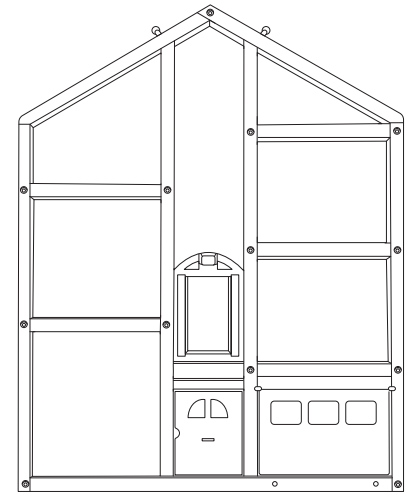

C front wall

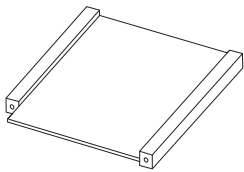

D right second floor (green)

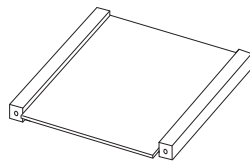

E left second floor (red)

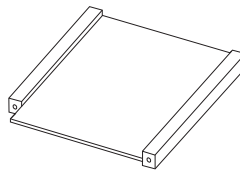

F right third floor (blue)

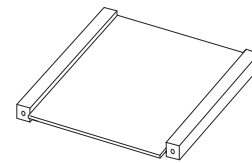

G left third floor (green)

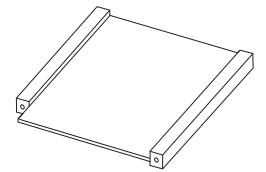

H right fourth floor (red)

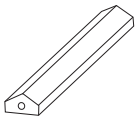

I roof beam



J garage ramp

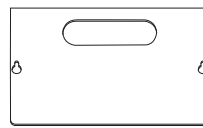

K left roof panel

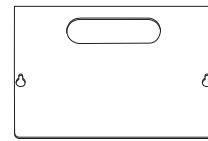

L right roof panel

HARDWARE

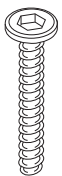

M short bolt (21)



N barrel nut (26)

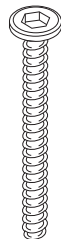

O long bolt (5)



P Allen wrench

ACCESSORIES

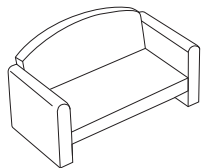

couch

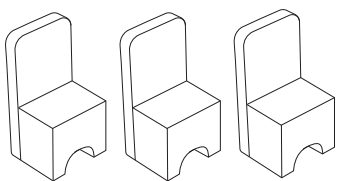

chairs (3)



small table

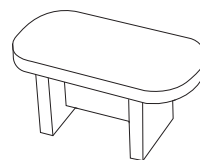

large table

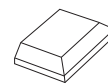

pillow

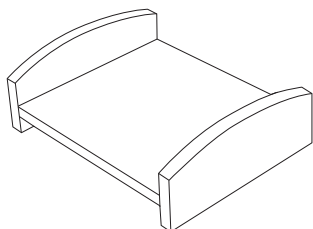

large bed

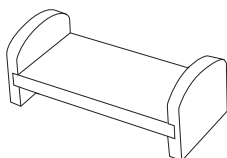

small bed

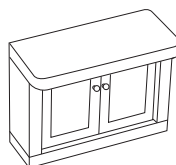

cabinet

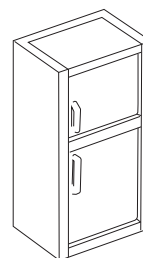

refrigerator

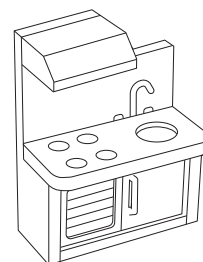

kitchen countertop

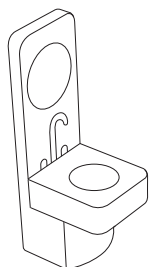

bathroom sink

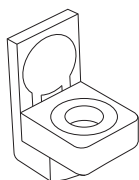

toilet

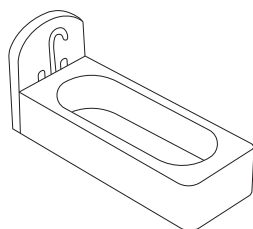

tub

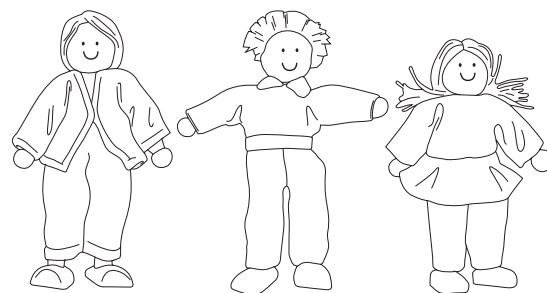

3 play figures

Helpful Hints and Tips

- Note: Some packages of hardware may have extra pieces.
- You will need either a Phillips head or a standard screw driver (not included) to assemble the dollhouse.
- Loosely tighten all bolts until the final step.

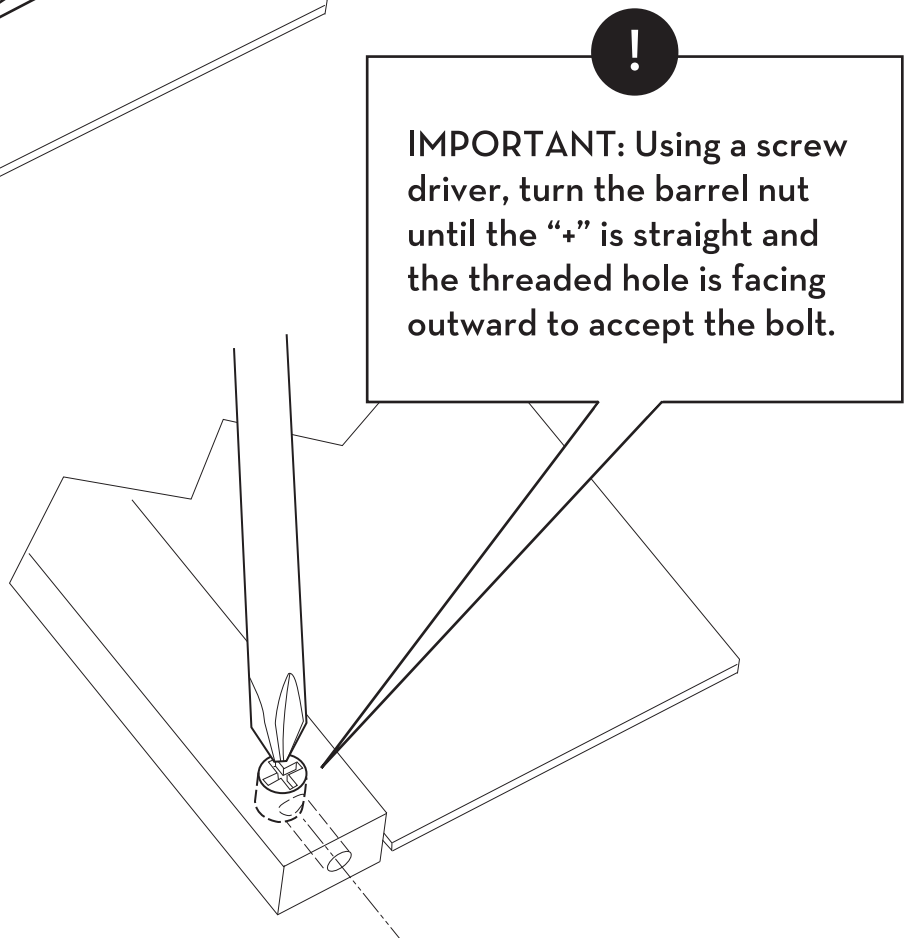
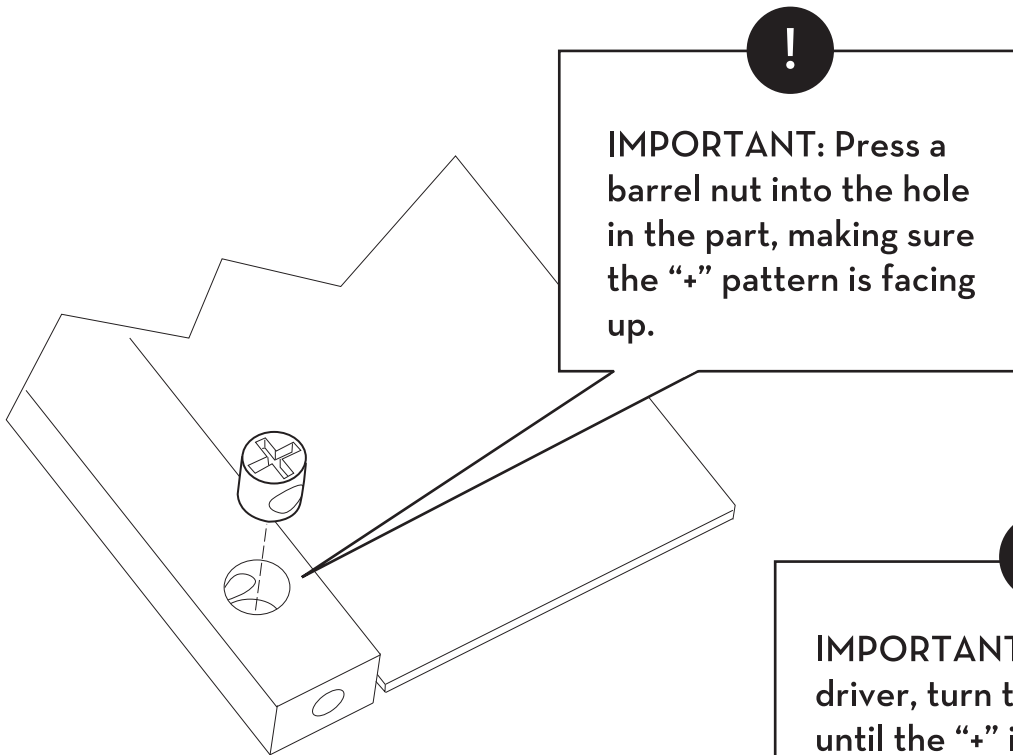

STEP 1 - Every Journey Begins with the First Step

Using 2 short bolts (part M) and 2 barrel nuts (part N), attach the base (part A) to the rear wall (part B).

!
IMPORTANT:
 Loosely tighten all bolts until the final step.

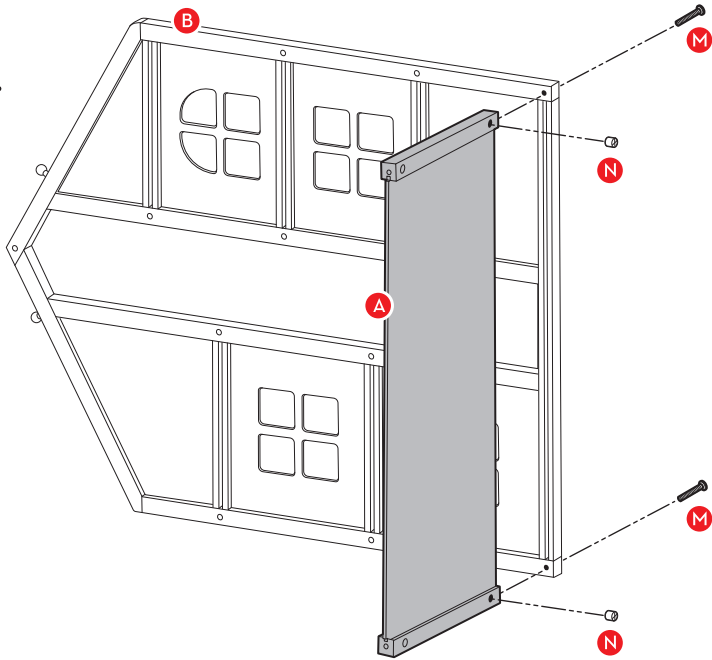
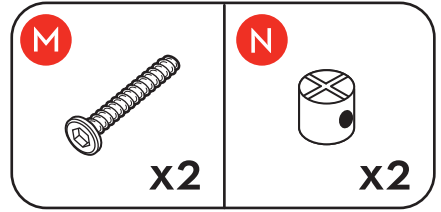

!
IMPORTANT: Be sure the artwork on the base is facing the correct direction. The rock pattern should be on the right.

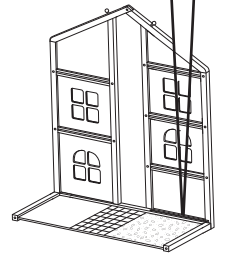

Assembled View

STEP 2 - The Front Wall Has It All

Using 2 short bolts (part M) and 2 barrel nuts (part N), attach the front wall (part C) to the base.

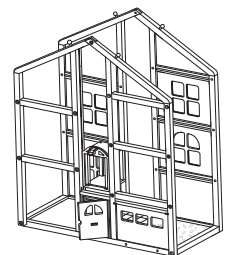
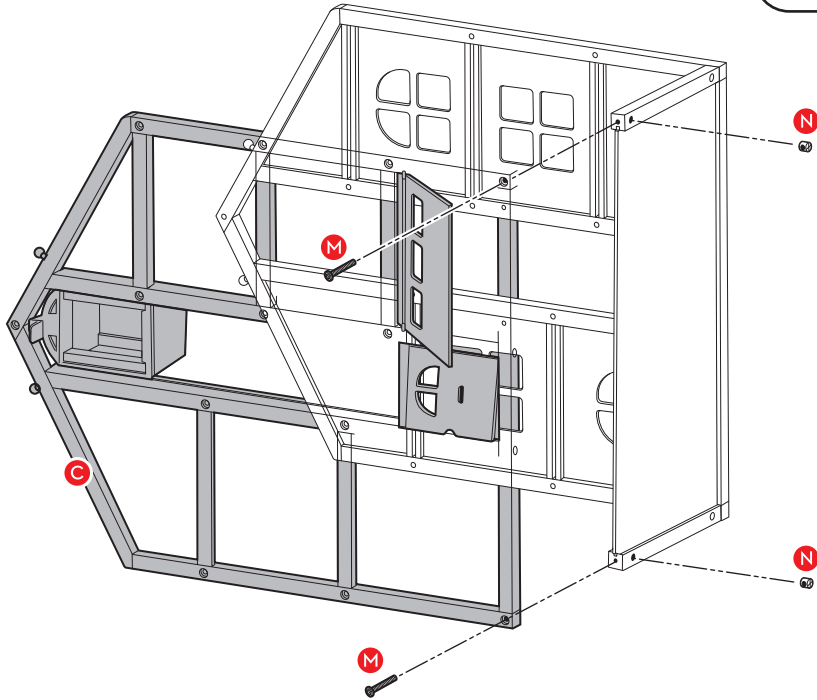
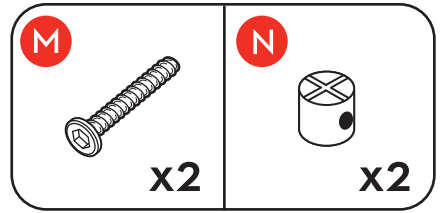

Assembled View

STEP 3 - Feeling Groovy

- First, insert 4 barrel nuts (part N) into the right side second floor (part D: Green) and 4 barrel nuts (part N) into the left side second floor (part E: Red).
- Second, with the barrel nut holes facing the bottom of the dollhouse, slide both floors (parts D & E) into the wall grooves. Insert the floors into the front wall grooves first, then attach them to the dollhouse using 6 small bolts (part M) along the back and outer edges and 2 long bolts (part O) on the rails on the inner front wall.

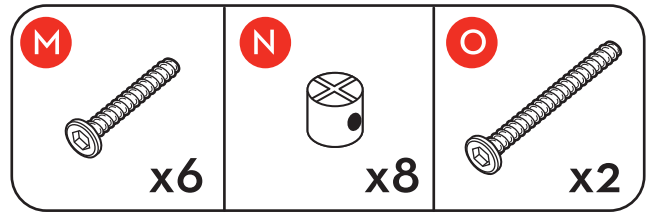

!
IMPORTANT: Loosely tighten all bolts until the final step.

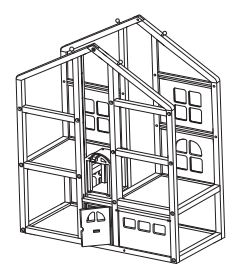
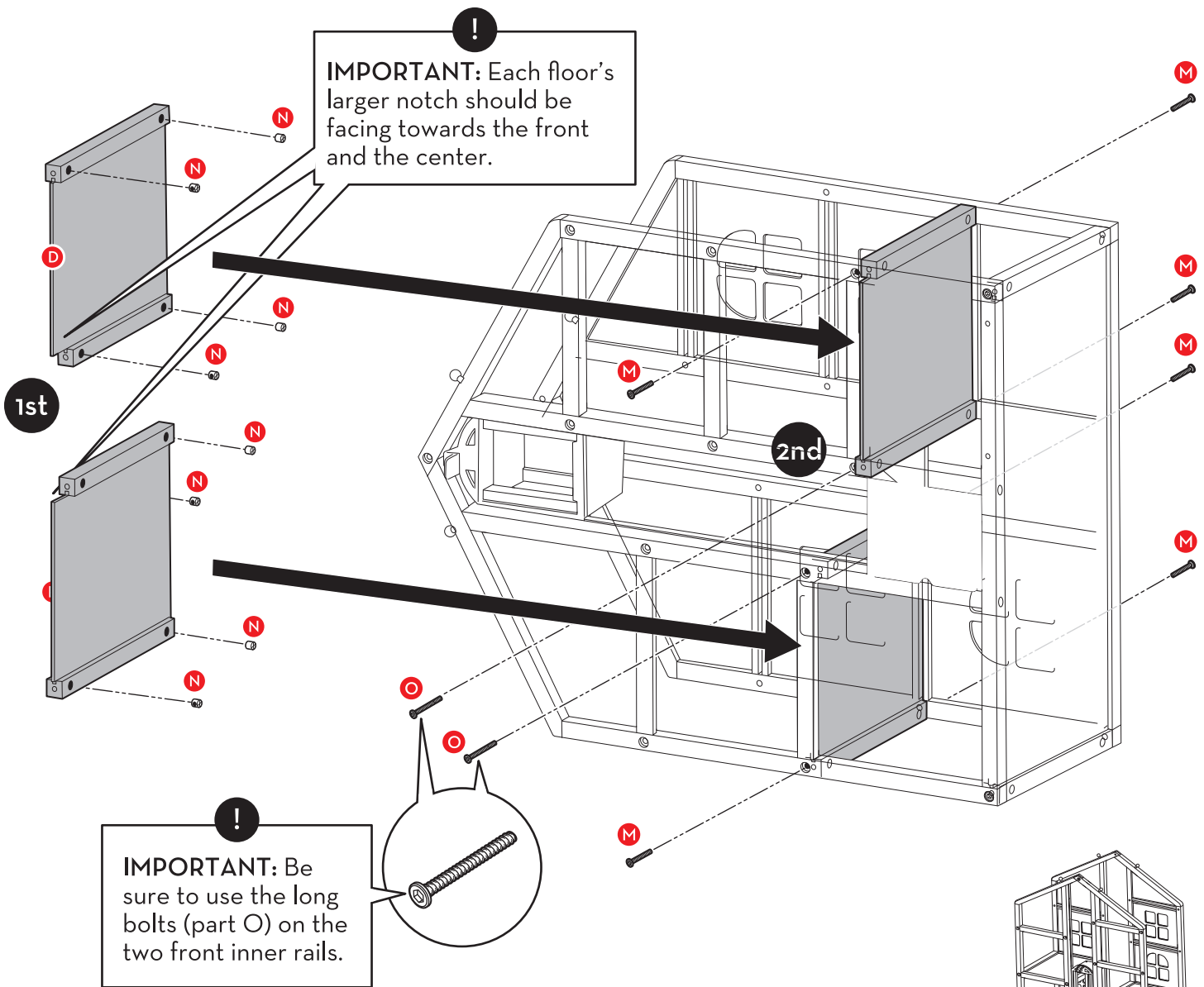

Assembled View

STEP 4 - Whee ... Floor Three!

- First, insert 4 barrel nuts (part N) into the right side third floor (part F: Blue) and 4 barrel nuts (part N) into the left side second floor (part G: Green).
- Second, with the barrel nut holes facing the bottom of the dollhouse, slide both floors (parts F & G) into the wall grooves. Insert the floors into the front wall grooves first, then attach them to the dollhouse using 6 small bolts (part M) along the back and outer edges and 2 long bolts (part O) on the rails on the inner front wall.

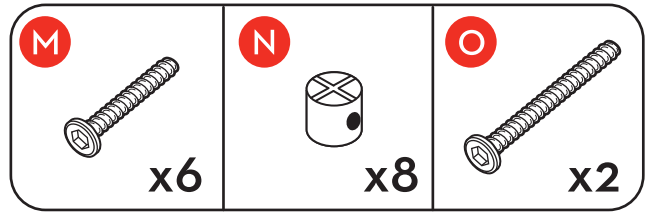

!
IMPORTANT: Loosely tighten all bolts until the final step.

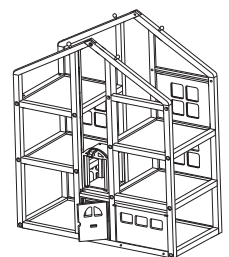
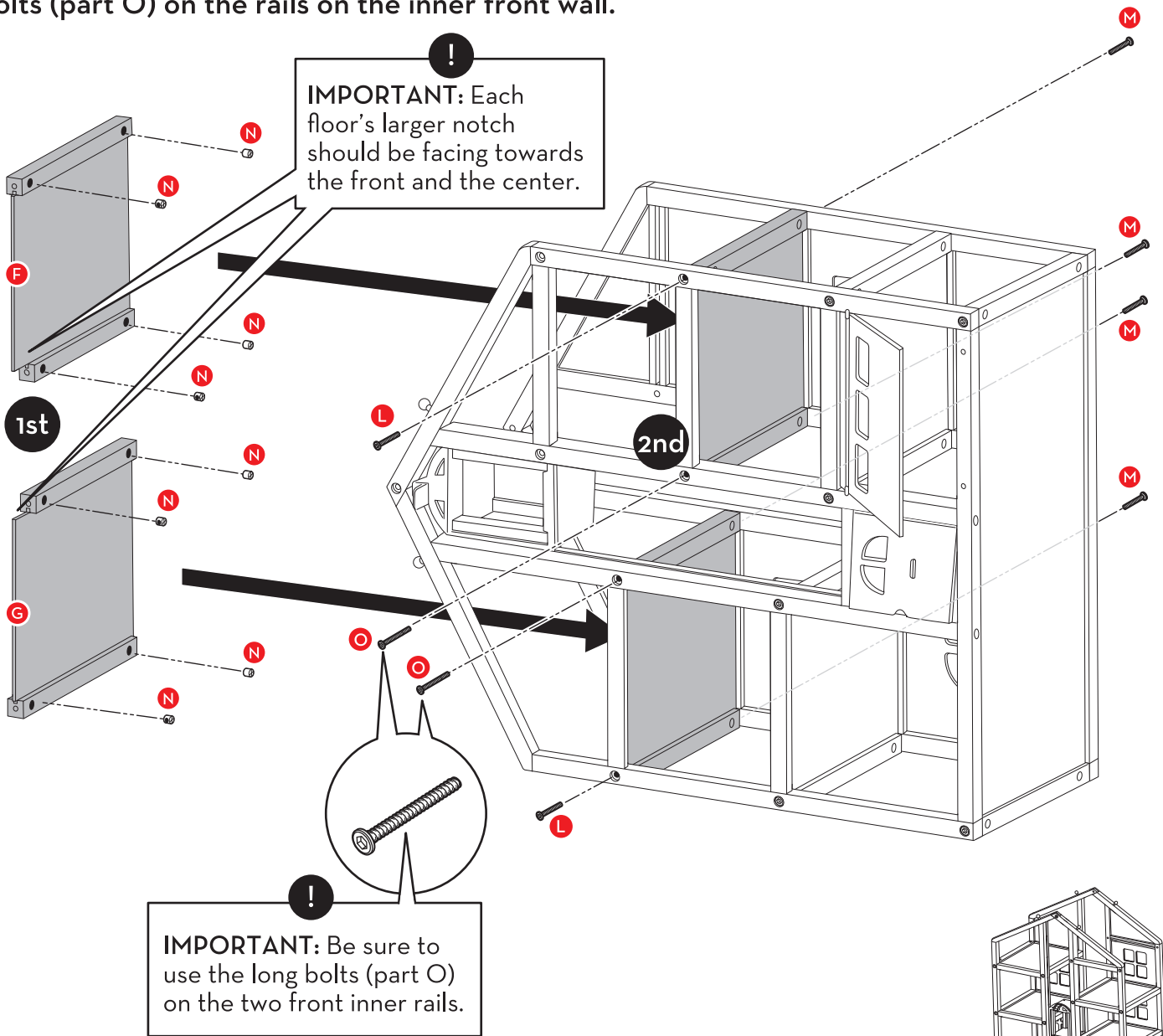

Assembled View

STEP 5 - Top This

- First, insert 4 barrel nuts (part N) into the right side fourth floor (part H: Red).
- Second, with the barrel nut holes facing the bottom of the dollhouse, slide floor into the wall grooves. Insert the floors into the front wall grooves first, then attach them to the dollhouse using 3 small bolts (part M) along the back and outer edge and 1 long bolt (part O) on the rail on the inner front wall.

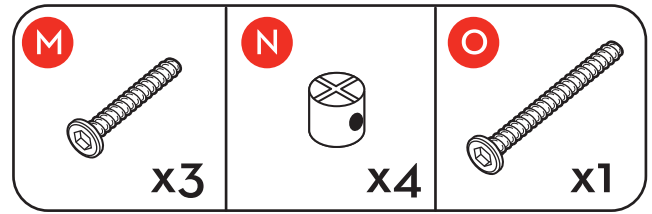

!
IMPORTANT: Loosely tighten all bolts until the final step.

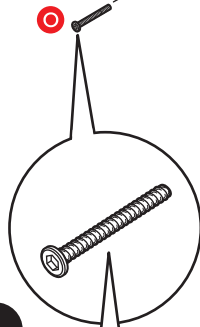
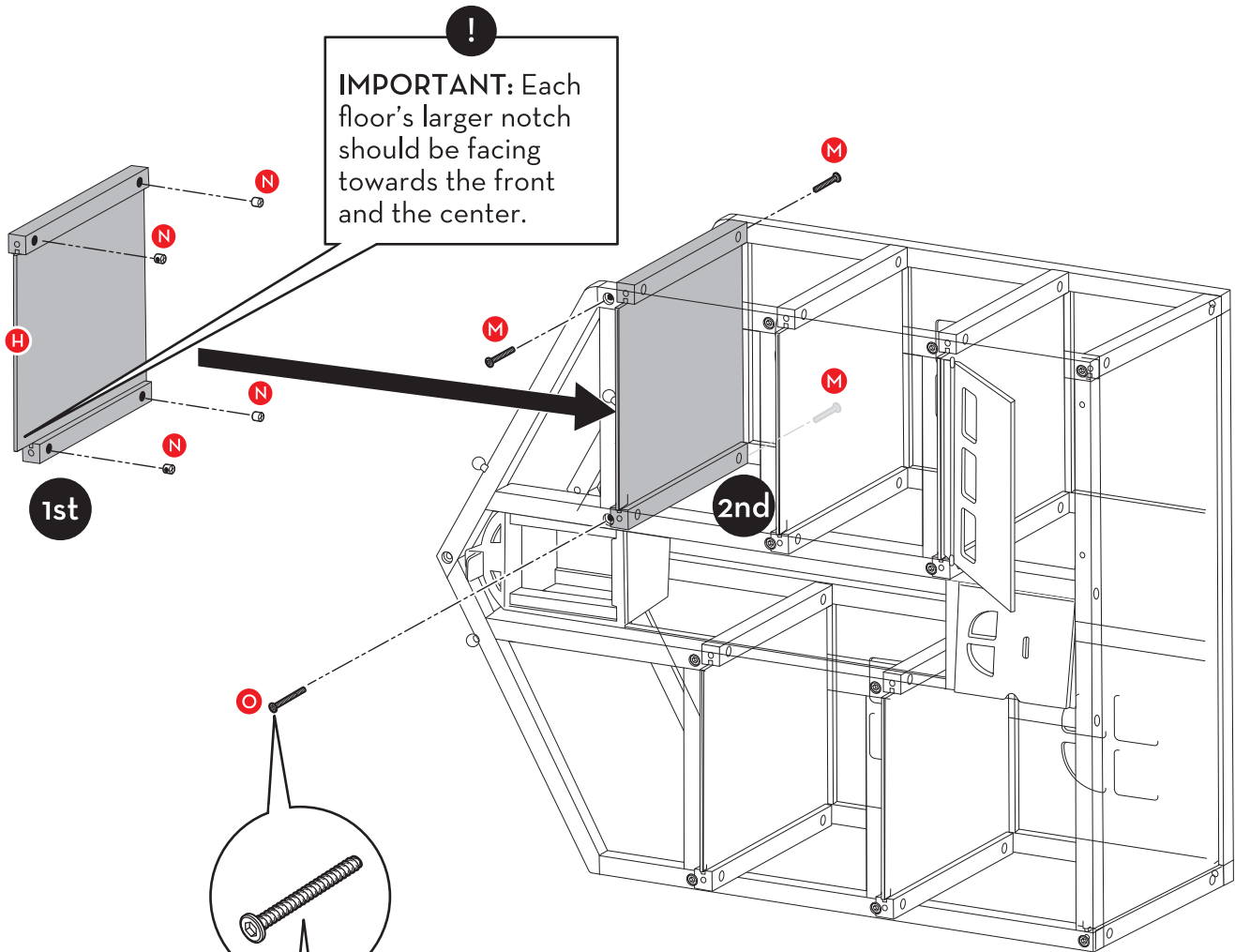

!
IMPORTANT: Be sure to use the long bolt (part O) on the front inner rails.

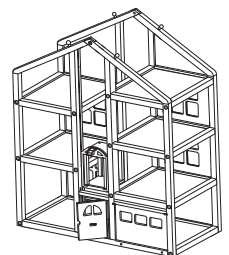

Assembled View

STEP 6 - Beam Me Up

- Using 2 short bolts (part M) and 2 barrel nuts (part N), attach the roof beam (part I) to the front and rear walls.
- Second, attach the garage ramp (part J) by inserting it into the 2 holes along base of the dollhouse.

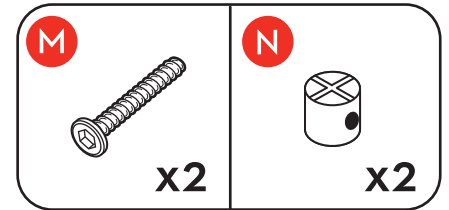

!
IMPORTANT:
Loosely tighten all bolts until the final step.

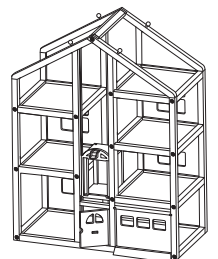
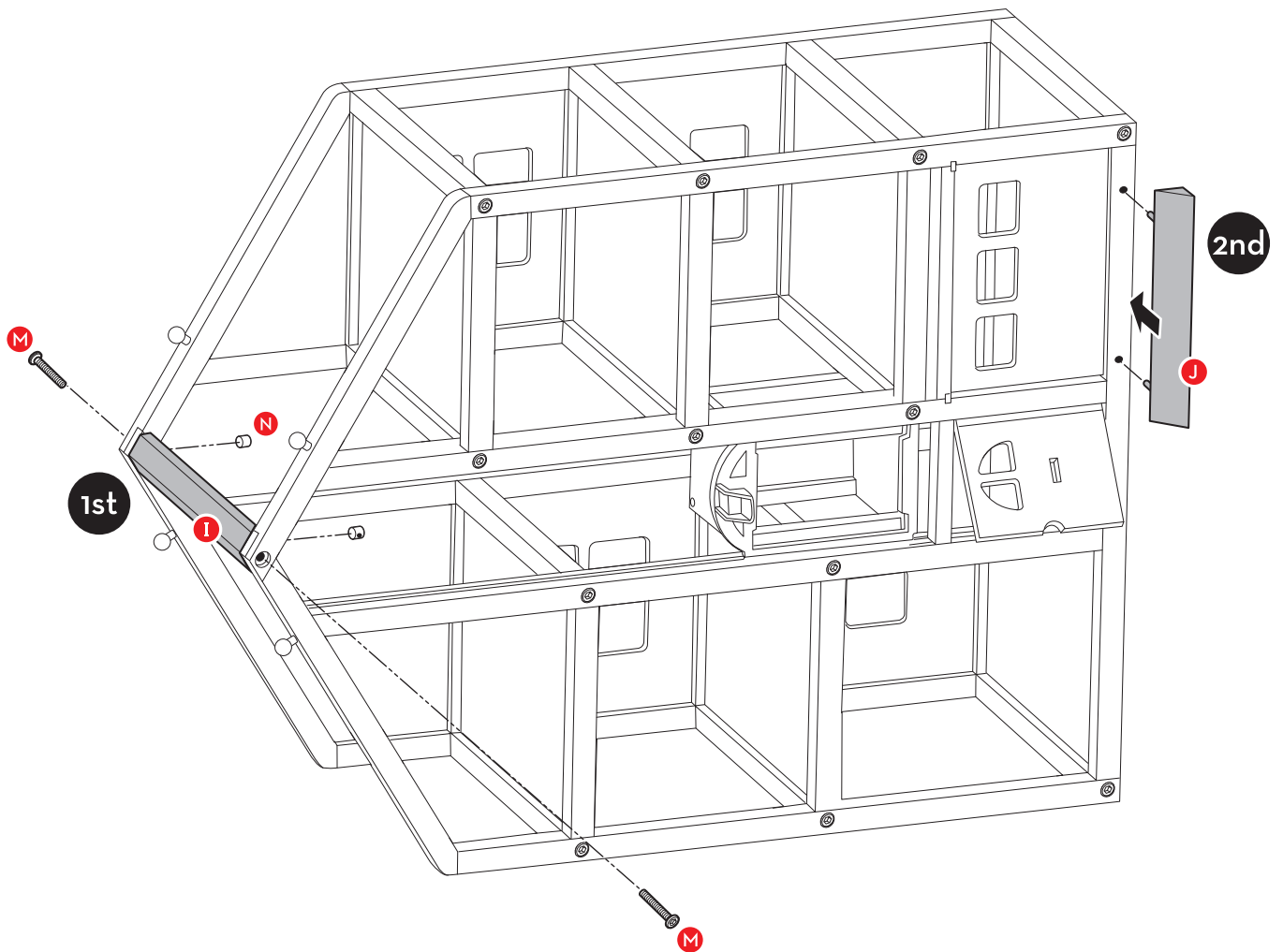

STEP 7 - Righty Tightly

- First, place the left and right roof panels (parts K and L) onto the respective left and right roof pegs. Slide them down to lock into place.
- Second, return to each bolt and fasten tightly.

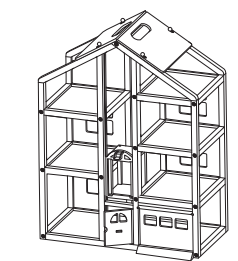
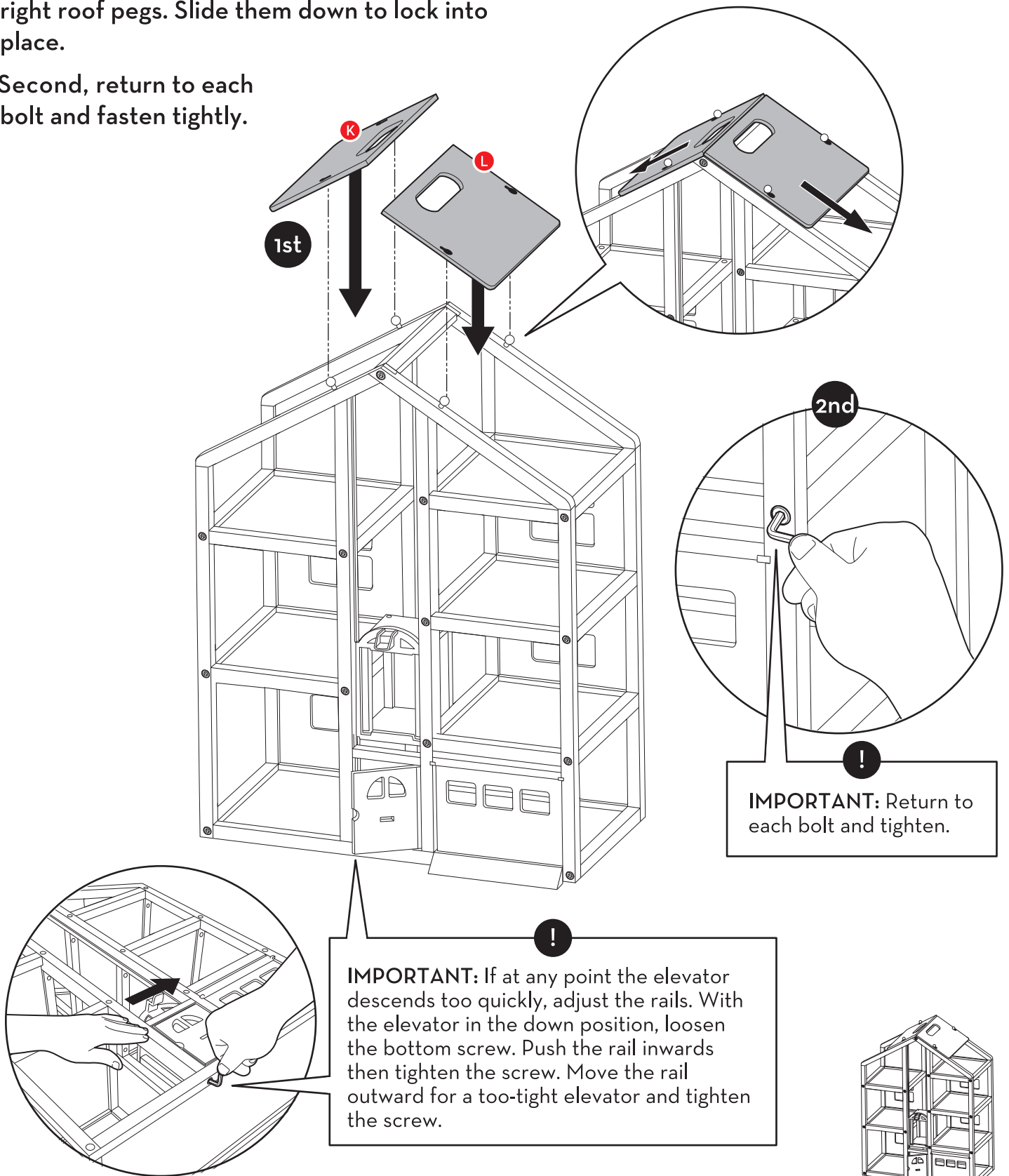

Assembled View

YOU DID IT!

Now the real fun begins—it's time let imaginations turn this house into a home! Here are some of the special features of the Hi-Rise Dollhouse:

- **15 PIECES OF FURNITURE:** There are sturdy wooden pieces to fill every room, and lots of options when it's time to rearrange. Pieces include a refrigerator, kitchen sink and stove, table and chairs, couch, TV and console, bathtub, sink, and toilet, double bed, single bed, and side table. Plastic cabinet doors open and close for more hands-on fun.
- **3 POSEABLE PLAY FIGURES:** These miniature wooden figures are right at home in the dollhouse or playing in any imaginative setting! The three poseable people are flexible so they can sit on the couch, lie down in bed, or stand at the stove.
- **HAND-OPERATED ELEVATOR:** Contemporary living in the Hi-Rise Dollhouse includes modern conveniences like a working elevator! Hop in and ride from the ground floor all the way to the attic and every floor in between!
- **GARAGE:** Lift the durable, top-hinged garage door and roll up the front ramp into the ground-level garage. It's the perfect place to park the Melissa & Doug Road Trip Car & Doll Set or toy cars already in your fleet.
- **4 STORIES & 6 SPACIOUS ROOMS:** There's plenty of room to let imaginative play blossom and grow!
- **REMOVABLE ROOF & OPEN SIDES:** It's easy to access every room and to share the fun with brothers, sisters, and friends.
- **BRIGHT DECOR:** The sturdy frame of this dollhouse is blonde wood, but every room has a different look, with fresh colors and patterns. The furniture coordinates with all of them, offering lots of decorating options.
- **1:12 SCALE:** Fits most standard dollhouse furniture and dolls for even more play options!

ACCESSORIZE

The Melissa & Doug Road Trip Car & Doll Set (#2463) and Doll Family (#2464) are designed to play perfectly with your Hi-Rise Dollhouse! Road Trip includes a wooden car and a set of four wooden poseable dolls; Doll Family is a seven-piece coordinating doll set, including a baby! To find these items and more, visit us at MelissaAndDoug.com!

