



**TWINFRESH
COMFO
RA1-50 V.3**

Power from
4.5 W

Air flow up to
50 m³/h

Sound pressure level from
13 dBA

**TWINFRESH
COMFO
RA1-85 V.3**

Power from
4.74 W

Air flow up to
85 m³/h

Sound pressure level from
19 dBA



The TwinFresh Comfo user-friendly ventilator ensures fresh and clean air with a comfort level of humidity in your house.

TWINFRESH



**FUNCTIONAL
AND RELIABLE**

UNIVERSAL

Many units can be connected to one network.

EFFICIENT

The ventilator can operate in a passive supply mode: the air shutters are open providing a natural air flow.

USER-FRIENDLY

The design of the unit allows easy maintenance of the ventilator.



The humidity threshold in the room can be controlled by choosing one of three modes on the remote control.



Night mode
The ventilator switches to the first speed in the dark time of the day.



Easy mounting of the mounting plate by means of magnets.

EASY CONTROL



The TwinFresh Comfo series ventilators are equipped with a remote control.

Operation modes:

- Night mode

The integrated light sensor sends a signal to switch the ventilator to low speed mode.
- Speed switching
- Passive air supply

In this mode the shutters are open, but the fan does not operate.
- Air supply

In this mode all ventilators will operate in supply mode irrespective of the maximum air supply setting.
- Ventilation

All the ventilators in the network operate in permanent air extract or air supply mode. To ensure balanced ventilation at the stage of installation it is advisable to set one half of the ventilators to air supply mode and the other part of the ventilators to air extract mode.
- Ventilation with heat recovery
- Humidity control mode selection

The ventilators can be connected into one network for centralized control. The signals from the control panel and the remote control, as well as from the humidity sensor, are received only by the master (main) ventilator.

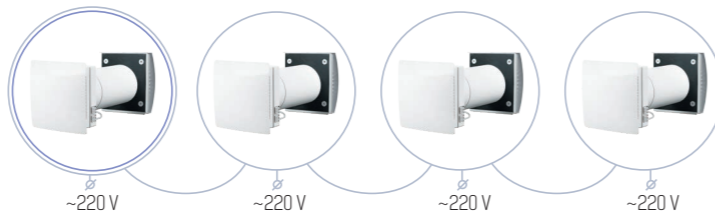

ADVANTAGES



Maximum ease of installation – mount into the wall, plug in and use.



Normal operation of the unit at temperatures down to -20 °C (-30 °C with a hood for a cold climate).



Connecting a large number of units to the network using control cables.



Automatic blocking off draughts by means of louver shutters when the unit is switched off.



Ventilation of premises with the area of about 40 m² (the area is approximate and depends on the ventilation standards in your country).



High efficiency – up to 90 %.



Built-in humidity sensor for automation of unit operation.



Control via remote control or buttons on the unit casing.



Noise from 13 to 34 dBA.



Higher degree of supply air purification can be achieved with an F7 filter.



Electrical fuse on the board for increased electrical safety.



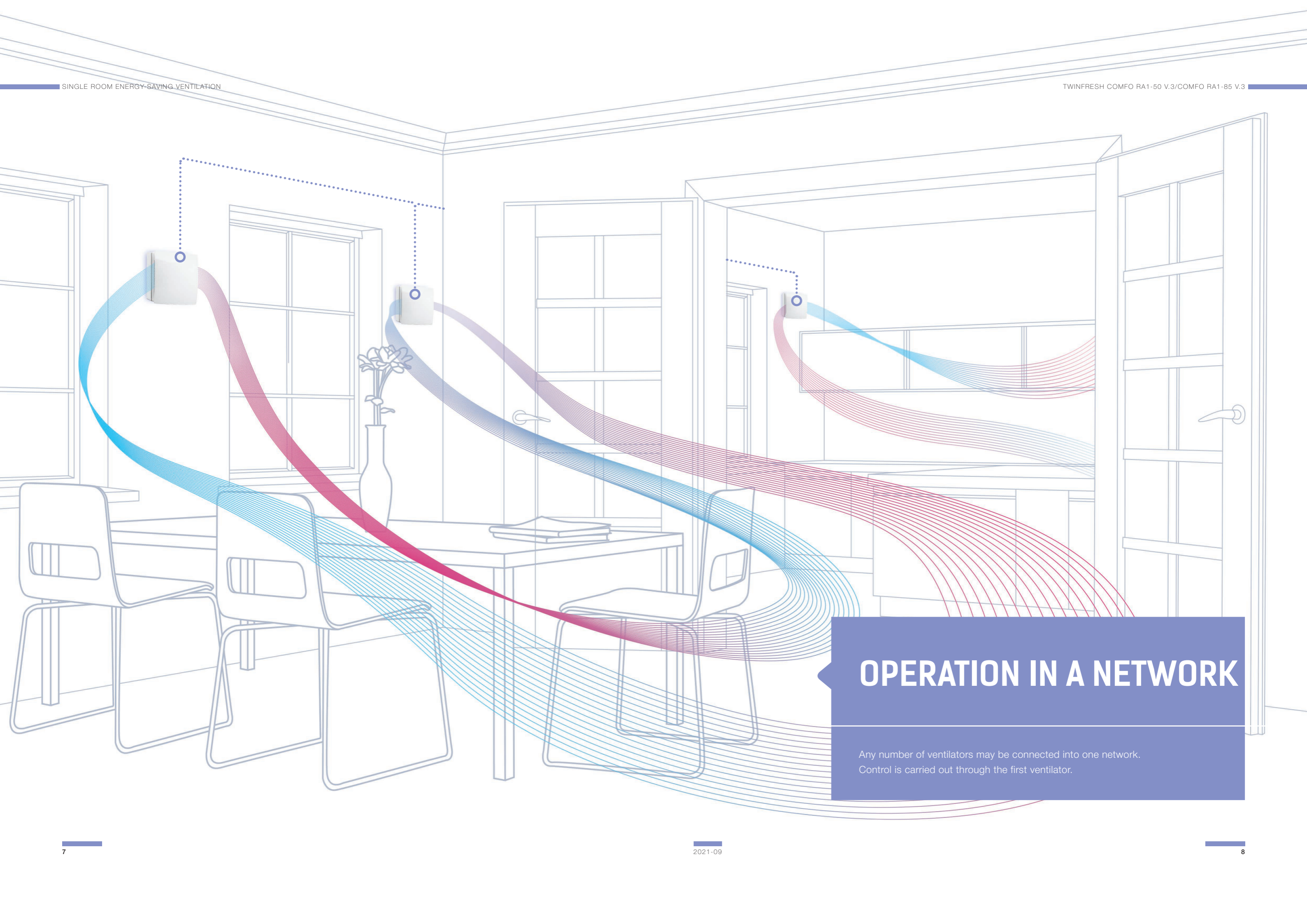

OPERATION IN A NETWORK

Any number of ventilators may be connected into one network.
Control is carried out through the first ventilator.

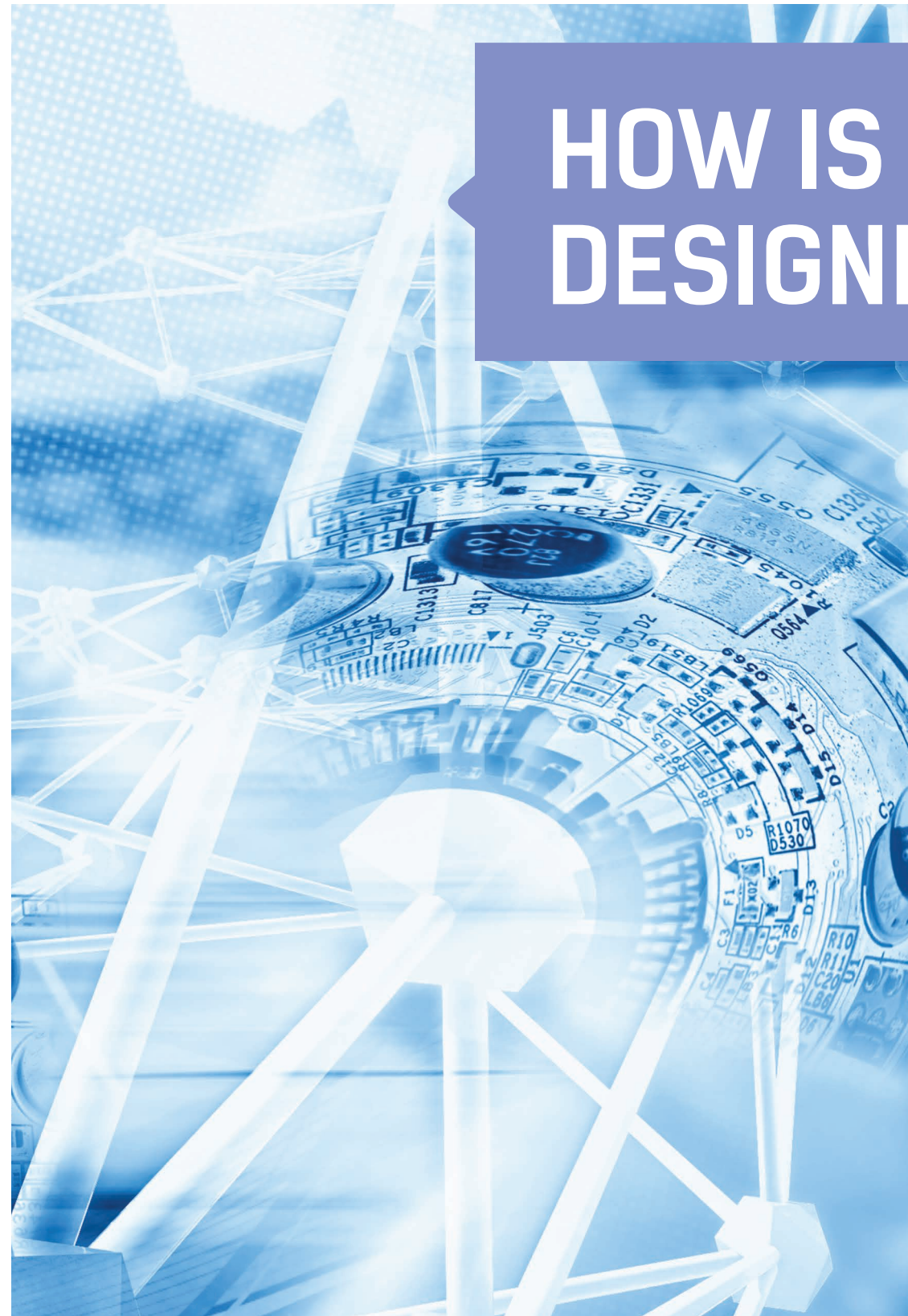

**HOW IS IT
DESIGNED?**

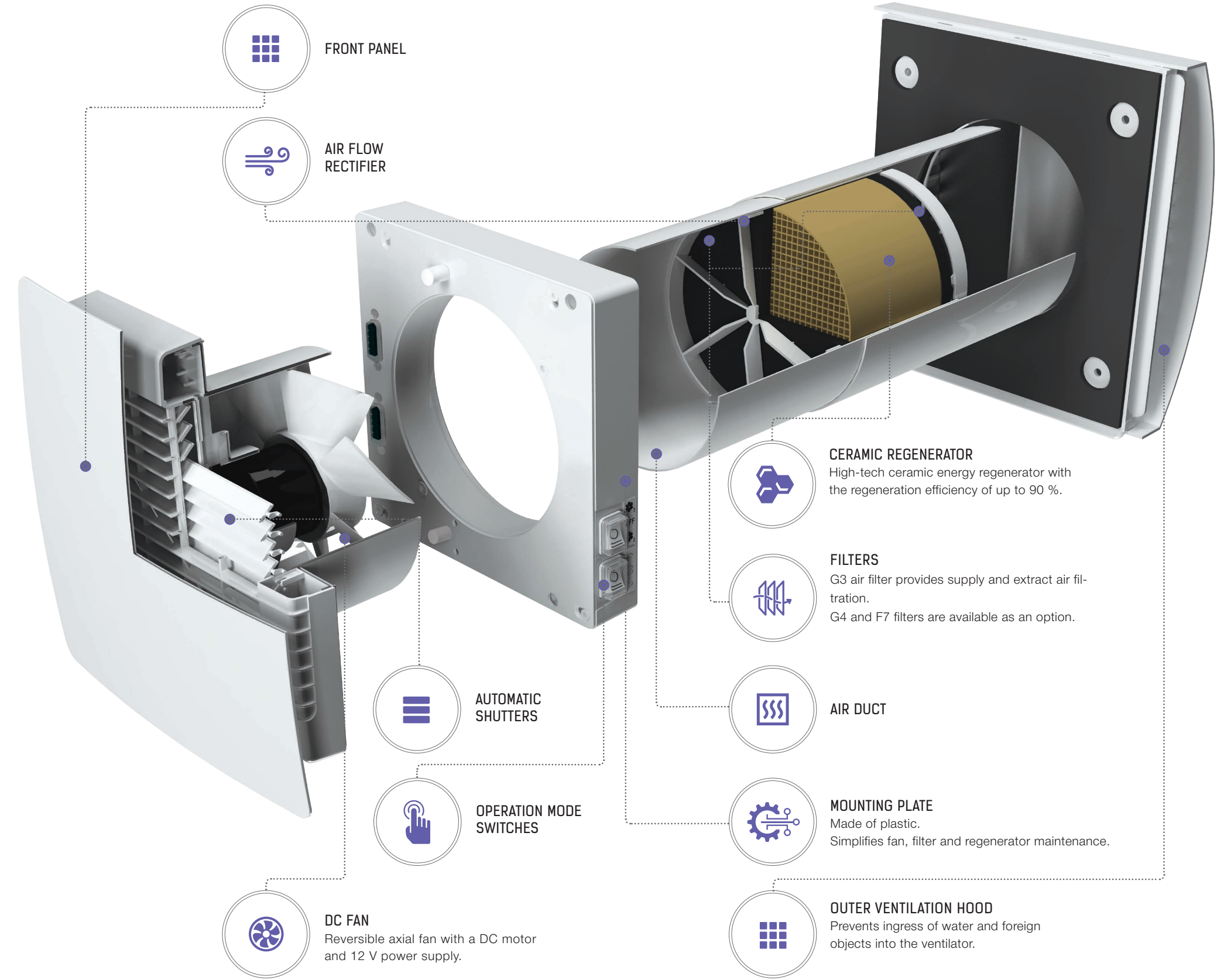

TECHNICAL DATA

Model	TwinFresh Comfo RA1-50 V.3			TwinFresh Comfo RA1-85 V.3		
	I	II	III	I	II	III
Speed						
Unit voltage [V/50 (60) Hz]	100-240 / 50-60			100-240 / 50-60		
Power [W]	4.5	5	7	4.74	6.56	9.65
Current [A]	0.024	0.026	0.039	0.034	0.050	0.071
Air flow in ventilation mode [m³/h (l/s)]	20 (6)	35 (10)	50 (14)	36 (10)	59 (16)	85 (24)
Air flow in energy recovery mode [m³/h (l/s)]	10 (3)	18 (5)	25 (7)	18 (5)	30 (8)	43 (12)
SFP [W/l/s]	1.62	1.03	1.01	0.59	0.8	0.82
Filter	G3 (G4, F7 optional)					
Transported air temperature [°C]	-20*...+40					
Sound pressure level at 1 m distance [dBA]	22	29	32	29	35	44
Sound pressure level at 3 m distance [dBA]	13	20	23	19	25	34
Outdoor sound pressure attenuation in accordance with DIN EN 20140 [dBA]	40					
Heat recovery efficiency in accordance with DIBt LÜ-A 20 [%]	≤ 88			≤ 90		
Protection class	IP24					

* -30°C when the EH-13 hood is applied.

OVERALL DIMENSIONS

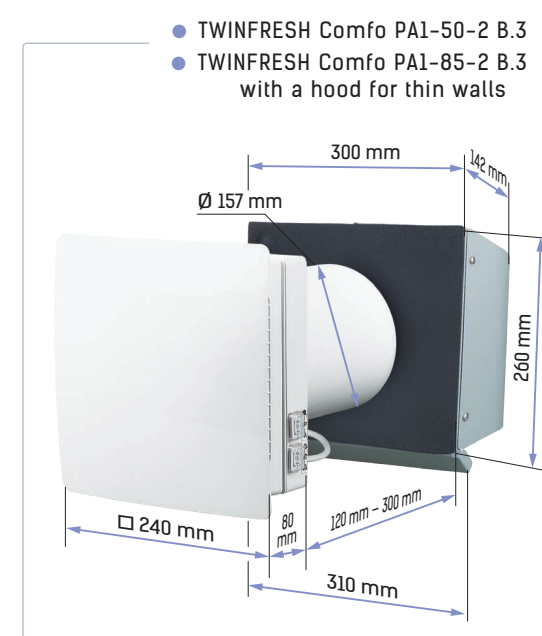
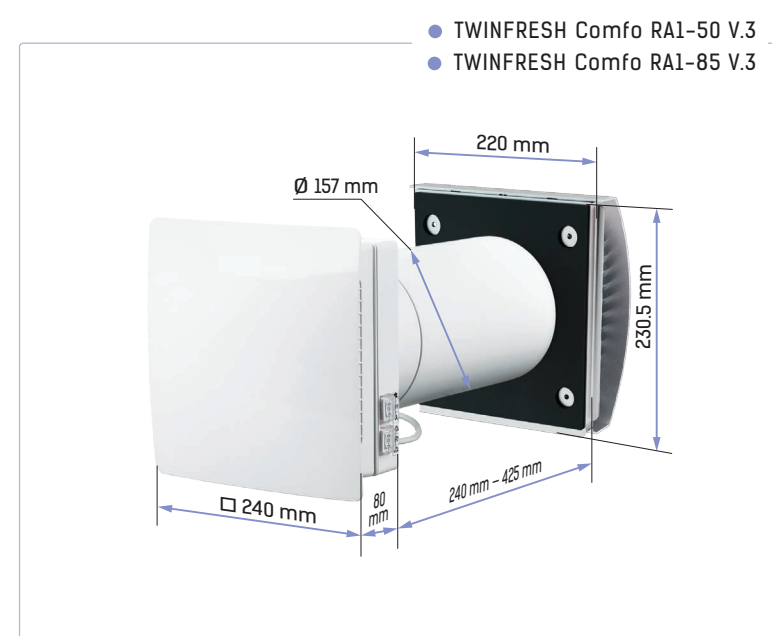





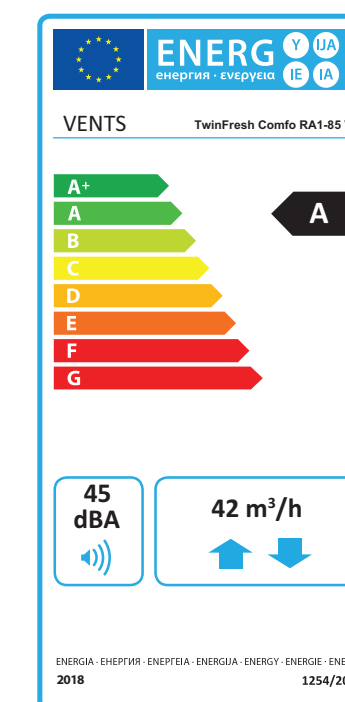
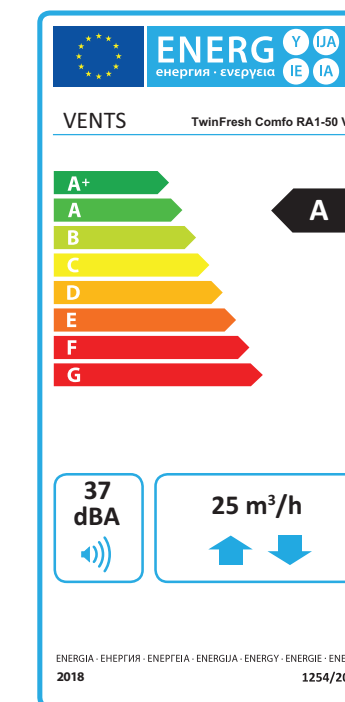















ECODESIGN



Model	TwinFresh Comfo RA1-50 V.3			TwinFresh Comfo RA1-85 V.3								
	Cold	Average	Warm	Cold	Average	Warm						
Specific energy consumption (SEC) [kWh/(m².a)]	-82	A+	-39	A	-15	E	-78	A+	-38	A	-15	E
Type of ventilation unit	Bidirectional											
Type of drive installed	Three-speed											
Type of heat recovery system	Regenerative											
Thermal efficiency of heat recovery [%]	80			69								
Maximum air flow rate [m³/h]	25			42								
Power [W]	7			9.65								
Sound power level [dBA]	36.7			45								
Reference air flow rate [m³/s]	0.004			0.008								
Reference pressure difference [Pa]	0			0								
Specific power input (SPI) [W/(m³/h)]	0.286			0.222								
Control typology	Local automatic control											
Maximum internal leakage rate [%]	2.7											
Maximum external leakage rate [%]	0											
Mixing rate of bidirectional units [%]	1											
Classification of the airflow sensitivity to pressure variations, according to EN 13141-8 [%]	0.4											
Classification of the indoor/outdoor air tightness, according to EN 13141-8 [m³/h]	-											
Internet address	http://www.ventilation-system.com											
Annual electricity consumption (AEC) [kWh electricity/a]	Cold	Average	Warm	Cold	Average	Warm						
	206	206	206	161	161	161						
Annual heating saved (AHS) [kWh primary energy/a]	Cold	Average	Warm	Cold	Average	Warm						
	8695	4445	2010	8205	4194	1897						







ACCESSORIES

Hoods	EH-14 white 160		Plastic hood. Colour options:       White Black Grey Terracotta Brown Beige
	EH-14 chrome 160		Grey plastic outer hood with a brushed stainless steel cover
	EH-17 white 160		Plastic hood. Colour options:       White Black Grey Terracotta Brown Beige
	EH-2 grey 160		Grey painted stainless steel outer hood for thin walls
	EH-2 chrome 160		Polished stainless steel hood for thin walls
	EH-13 white 160		White painted aluminium outer hood for cold climate
	EH-13 chrome 160		Stainless steel ventilation hood for cold climate
	MVVM 162 05		Hood for mounting from inside



Grilles	MVMO 150 bV1s An		Round metal grille
	MVM 152 bVs N		Round stainless steel hood

Angular mounting	NP 60x204-0021		Kit for angular mounting with white colour grille
	NP 60x204-0082		Kit for angular mounting with stainless steel outer grille

Mounting elements	3805		Round telescopic air duct 300-500 mm
	3810		Round telescopic air duct 500-1000 mm

Kits for mounting	TwinFresh R-50 pre-installation kit		Kit for pre-installation
	TwinFresh Comfo RA1-50 V.3 completion kit		Completion kit (for the TwinFresh Comfo RA1-50 V.3 model)

Ventilator	RC TwinFresh Comfo R-50		Remote control
------------	-------------------------	---	----------------

Filters	SF TwinFresh R50 G3		G3 filter kit (2 pcs.)
	SFC 150x50 F7		F7 filter
	SFC 150x50 G4		G4 filter