





PARTS LIST	
Quantity	Description
46	78" Poles 
14	36" Poles 
	<div style="display: flex; justify-content: space-around; align-items: center;"> <div style="text-align: center;">  2-Way Connectors 14 pcs. </div> <div style="text-align: center;">  3-Way Connectors 6 pcs. </div> <div style="text-align: center;">  4-Way Connectors 15 pcs. </div> </div>
1	20'x 40' Tarp / 18x40 Valance Top <small>Canopies require a top that measures two feet (2') wider than the frame due to the peak of the roof.</small>

Instructions for 18'x 40' Canopy

Roof and Top:

1. Place the roof pipes on the ground with the correct connectors next to them as shown in figure 1
2. Connect the pipes and connectors (figure 2).
3. Drape the tarp over the roof and secure the corners first (start with one corner and then the opposite corner) using the ball bungee's. Once the corners are secured, you may fasten the rest of the ball bungees into the remaining grommets (shown in figure 3). Please note: there will be a 4"-6" gap between the tarp and the pole.

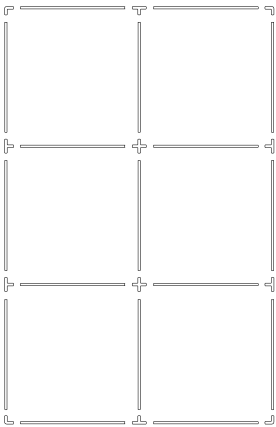

Figure 1

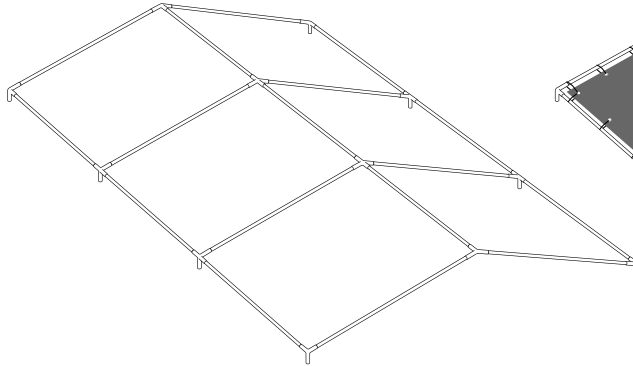

Figure 2

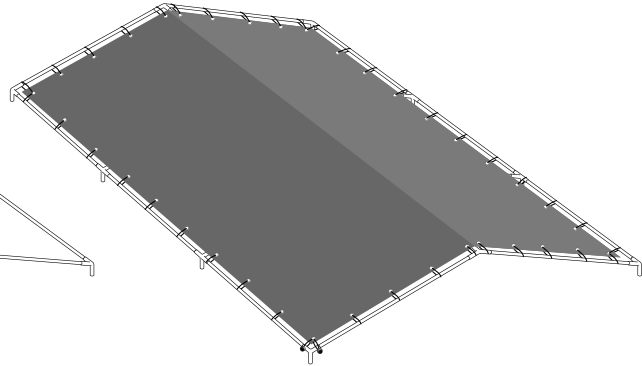

Figure 3

Attaching the legs:

4. Lift one side of roof and slide in the leg poles first. Lift other side and insert the remaining leg poles as illustrated in figure 4.
5. Lift other side of roof and secure canopy in upright position as shown in figure 5.

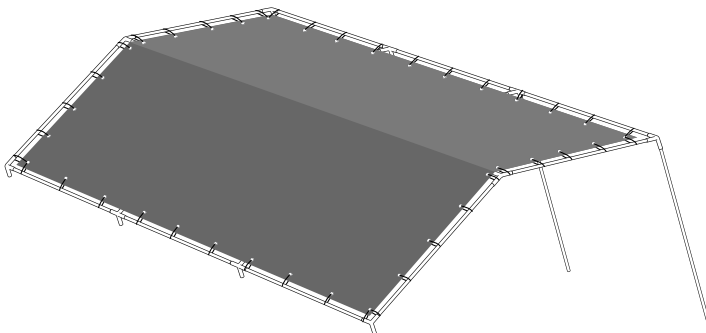

Figure 4

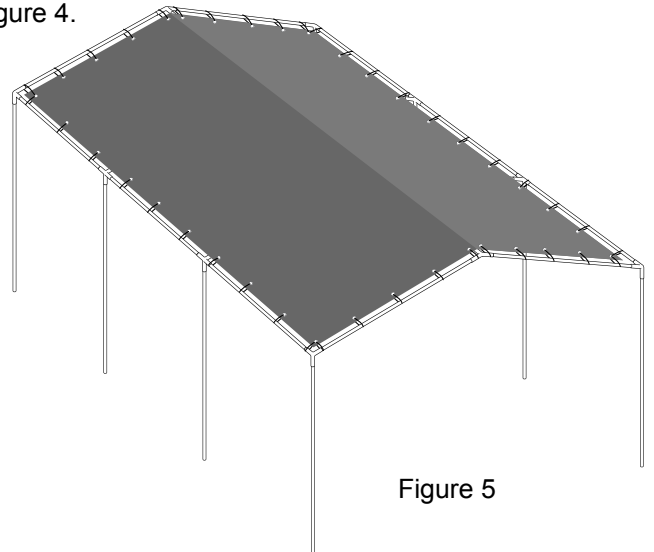

Figure 5

Additional Instructions for Your Safety

1. In windy areas the canopy can be anchored by using cement blocks, sand bags, or plastic water-filled jugs tied down with rope looped through the roof frame.
2. In regions where heavy snowfall may occur, snow must not be allowed to accumulate on the roof as the weight may cause the structure to collapse.

18'x 40' Canopy Frame Layout Top View

FRONT

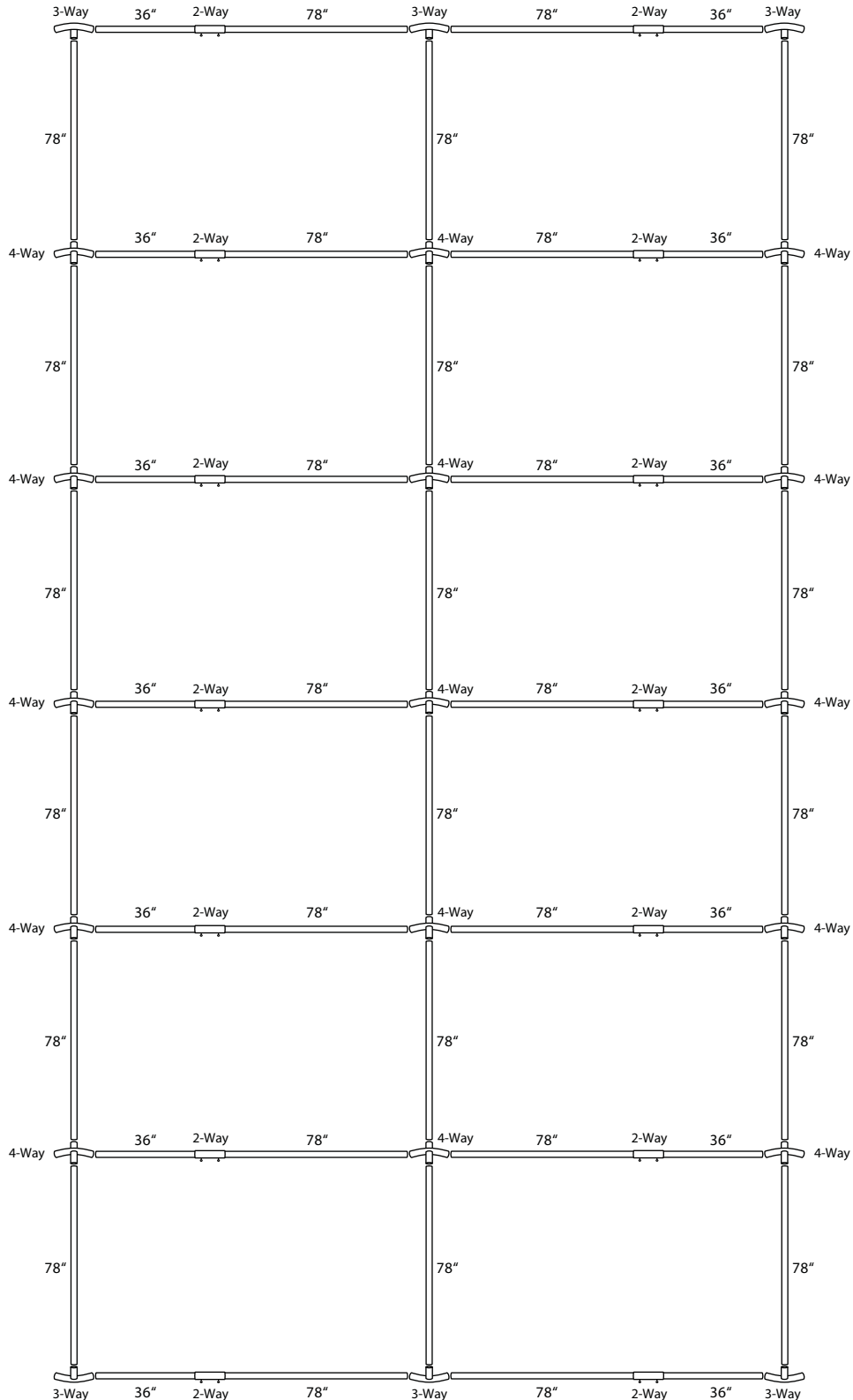

REAR

Instructions for using Ball Bungees

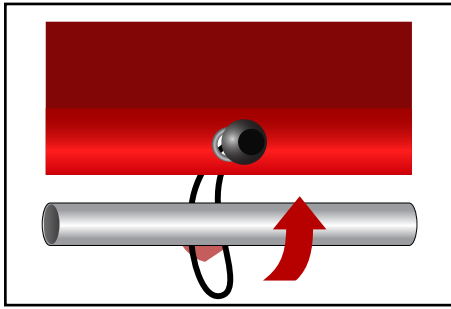

Pull string end of bungee through the grommet.

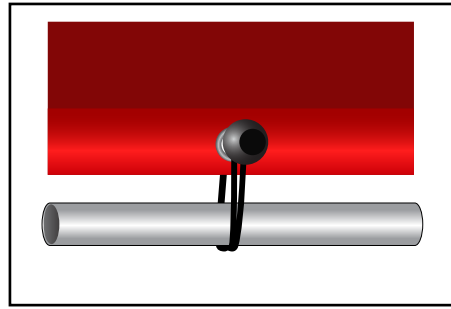

Wrap string around the pole and over the ball to secure it.

18'x 40' Canopy Perspective Frame Layout

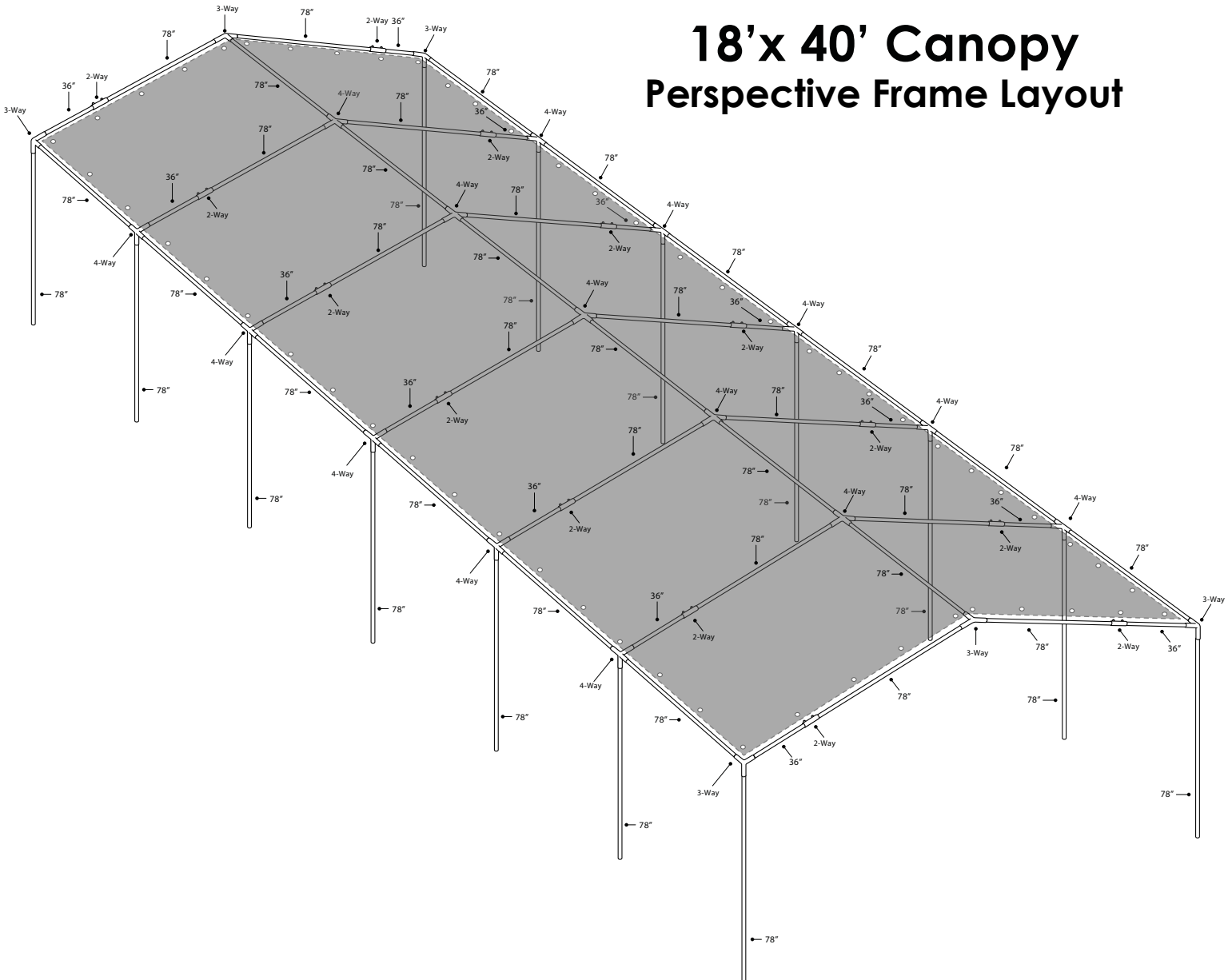

The canopy cover and any side walls or peak walls (sold separately) will be attached to the canopy frame using the same process illustrated above. Please note: side walls will also have the same 4" - 6" gap between the tarp and the pole.

Warranty Policy

We want you to be completely satisfied with every item that you purchase online from AceCanopy.com. We have a 30-day limited warranty. We will repair or replace any part of the canopy within 30 days of purchase if defective. This limited warranty does not cover damage due to neglect, wind, snow, fire, or misuse; nor does this limited warranty cover damage resulting from the canopy not having been securely fastened down nor from improper installation. Ace Canopy makes no other warranty and the remedy of repair or replacement is the exclusive remedy. Ace Canopy is not liable for indirect, incidental, or consequential damages in connection with the use of any product sold on this web site, including any cost or expense of providing substitute equipment or service during periods of non-use.