



VIC

P | 1800 337 778
F | 03 9587 7161
E | sales@churchfurniture.com.au
A | 3/152-154 Bangholme Rd,
Dandenong South, VIC 3175

WA

P | 1800 337 778
F | 08 9417 4009
E | sales@churchfurniture.com.au
A | 3 Pusey Road,
Jandakot, WA 6164

NSW

P | 1800 337 778
F | 02 9756 4991
E | sales@churchfurniture.com.au
A | 4-6 Bentley Street, Wetherill
Park, NSW 2164

NZ

P | 1800 337 778
F | (+64) 9 273 0145
E | sales@churchfurniture.com.au
A | Unit 15/ 180 Montgomerie Road,
Airport Oaks, Auckland 2154

QLD

P | 1800 337 778
F | 07 3260 2070
E | sales@churchfurniture.com.au
A | 4/272 Lavarack Avenue, Eagle
Farm QLD 4009





Exodus 40:9

“Take the anointing oil and anoint the tabernacle and everything in it; consecrate it and all its furnishings, and it will be holy.”

Church Furniture Tradition and Function

The furnishing of a place of worship is always a delicate balancing act, between the competing interest of appearance, functionality and cost. Finding the right balance between tradition and contemporary comfort requires fine judgement and good advice from people who have the know-how and track record that only comes from years of experience.

Churchfurniture.com.au is a division of **Reed Furniture** and has been supplying furniture for Churches in Australia and the region for nearly 50 years.

Many older Churches and Church furniture were built in a time when the only material available for construction and furnishings was timber and this has created a legacy of a particular look and feel within many traditional Churches; austere, somewhat dark and in some cases, forbidding to the newcomer.

More recent buildings have accentuated light and brighter colours creating a more accessible and comfortable ambience. Modern Church furniture reflects that change in style and emphasis. More modern furnishings welcome members of the

congregation and are congruous with the levels of comfort found in homes and other public buildings.

Furthermore modern Church furniture creates flexibility and opportunities to reconfigure space without being locked in to banks of fixed seating. It becomes possible to reconfigure Churches, halls, kindergartens, social centres and associated buildings for different purposes; perhaps a smaller study group, a special occasion, or a ceremony. It is possible to add and subtract furniture as needs dictate.

Many of the designs focus on this need for flexibility, folding, stacking or nesting for storage when not needed. Some seating products link together to create banks of seating, which can then be quickly disconnected for stacking and movement. Tables fold and roll for storage. Chair trolleys allow users to stack chairs together then safely and quickly roll them out of the way.

Some items in this range of Church furniture are new designs which have been successfully used overseas and are now being made available in Australia for the first time.

CHURCH FURNITURE PRODUCTS



CONTENTS

2 Church Seating

▶ LINKING SEATING	4
▶ TROLLEYS/BENCHES	7

8 Conference & Education Seating

▶ TABLET CHAIRS	10
▶ AUDITORIUM SEATING	10
▶ ADULT CHAIRS	11
▶ CHILDRENS CHAIRS	15

20 Conference & Education Other

▶ OUTDOOR	22
▶ TABLES	22
▶ SCREENS	26

28 Administration Furniture

▶ CLERICAL DESK	30
▶ CLERICAL CHAIRS	34
▶ STORAGE	38
▶ EDUCATION ACCESSORIES	39

Specialists in design and supply of Educational and Church furniture.



CHURCH SEATING

- Linking seating
- Trolleys/Benches



LINKING SEATING

LINKING SEATING



1. MATTHEW CHAIR

A slim line high back linking chair which combines elegant design and functionality. It's waterfall seat design promotes comfort making it ideal in halls, Churches and all function needs.

2. LUKE CHAIR

A wider chair with high density foam seat and back, Hymn book racks and linking mechanism included, making it ideal for all Church, hall and auditorium applications. Taller and wider seat is ideal for older congregations.

5. ROMANS SERIES

With it's unique leg over leg design the Romans chair is the fastest and easiest chair available to set up and breakdown large events and venues. Legs interlock in seconds. Tough PP shells suitable for indoor or outdoor.

IGCMATTRED.....RED
IGCMATBLU.....BLUE

IGCLUKRED.....RED
IGCLUKBLU.....BLUE

IGCROMCHON.....(CHARCOAL BACK) PP SEAT HONEY
IGCROMWHON.....(WHITE BACK) PP SEAT HONEY
IGCROMCUPSBHON.....(CHARCOAL BACK) FABRIC SEAT & BACK HONEY
IGCROMWUPSBHON.....(WHITE BACK) FABRIC SEAT & BACK HONEY
IGCROMCUPSHON.....(CHARCOAL BACK) FABRIC SEAT HONEY
IGCROMWUPSHON.....(WHITE BACK) FABRIC SEAT HONEY

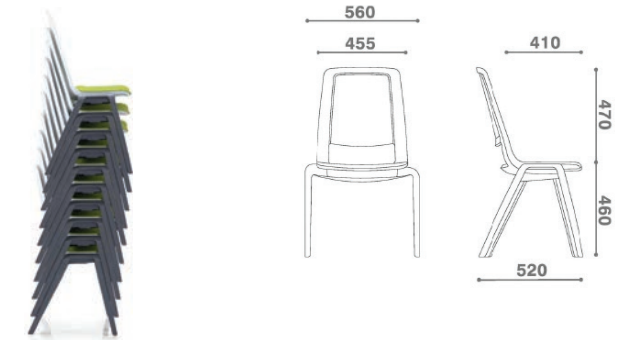

3. JOHN CHAIR

Wide, generous seat and back with high density foam. Includes linking mechanism making it an ideal multi-purpose chair. Taller and wider seat is ideal for older congregations.

4. ACTS CHAIR

With a stylish high density foam seat and back, Hymn book racks and linking mechanism included, making it ideal for all Church, hall and auditorium applications.

IGCJOHRED.....RED
IGCJOHBLU.....BLUE

IGCACTRED.....RED
IGCACTBLU.....BLUE



6. MARK CHAIR

Compact linked chair ideal for Church halls where space is at a premium. Built in carry handle with elegant simple design. Taller and wider seat is ideal for older congregations.

IGCMARRED.....RED
IGCMARBLU.....BLUE



LINKING SEATING

TROLLEYS/BENCHES



1. CHURNSIDE CHAIR

Classically stylish and practical, the Churnside is the ideal multi purpose chair. Fully upholstered with generous seat and back. Stackable and available with optional links. N.B. Links optional.

IGCCHULG455CHA.....CHARCOAL
IGCCHULG455BLU.....NAVY BLUE



2. CHURNSIDE CHAIR WIDE

A sturdy extra wide chair with comfortable high density foam. Fully upholstered with generous waterfall seat and back with optional links available. Ideal for multi purpose halls, aged care and nursing home applications. N.B. Links optional.

RGCCHUWLG455CHA.....CHARCOAL
RGCCHUWLG455BLU.....NAVY BLUE
RGCCHUWLG455WIN.....WINE



1. GENERAL PURPOSE TROLLEY

Ideal for quick and safe transportation of chairs. Easy move pneumatic rubber tyres and strong steel frame. Carpeted base and front protects chairs. Suits Matthew, Mark, Luke, John and Acts chairs. Footprint: W665 x D760 x H1250mm

IGCMLJATRL.....RED



2. ROMAN CHAIR TROLLEY

Fila chair trolley holds up to 10 chairs. Very simple and safe to use. Little strength required.

SYLFSFILTRY.....BLACK



3. CHURNSIDE CHAIR WITH ARMS

A sturdy extra wide arm chair with comfortable high density foam and padded arm rests. Ideal for aged care and nursing home applications. N.B. Links not available on churnside with arms.

RGCCHUALG455CHA.....CHARCOAL
RGCCHUALG455BLU.....NAVY BLUE
RGCCHUALG455WIN.....WINE



4. REMKO CHAIR

A robust linking chair with generous padding and a high level of comfort. Very stable. Stackable design. Suitable for multi purpose spaces.

SYLFSREMBK.....BLACK
SYLFSREMBL.....BLUE



Seat Dimensions for 3 seater: W1400 x D400 x H470mm
Seat Dimensions for 4 seater: W1850 x D400 x H470mm
Seat Dimensions for 5 seater: W2250 x D400 x H470mm

1. BENCH SEATING

Custom built to your requirements from high grade materials. High density foam seat for extra comfort. Available in 3, 4 or 5 seat configurations.

RGCBENCH3SBLK.....3 SEATER BLACK
RGCBENCH4SBLK.....4 SEATER BLACK
RGCBENCH5SBLK.....5 SEATER BLACK



Seat Dimensions for 3 seater: W1350 x D400 x H460mm
Seat Dimensions for 4 seater: W1800 x D400 x H460mm
Seat Dimensions for 5 seater: W2250 x D400 x H460mm

2. INSPIRATION CHURCH PEW

A sturdy steel framed pew which is custom built to your requirements. Extra comfy seat and back and available in 3, 4 or 5 seat configurations. Options include: Hymn book racks, communion glass holders and deluxe padding.

RGCPWDELX3SIWIN.....3 SEATER DELUX WINE
RGCPWDELX4SIWIN.....4 SEATER DELUX WINE
RGCPWDELX5SIWIN.....5 SEATER DELUX WINE

CONFERENCE & EDUCATION SEATING

- Tablet chairs
- Auditorium seating
- Adult chairs
- Childrens chairs



TABLET CHAIRS



1. WEBSTER CHAIR WITH ARMS AND TABLET

Webster is a family of classic visitor chairs which come in a variety of modes: No arms, with arms and with arms & tablet. Classics never date.

IGCWEBATBK.....BLACK
IGCWEBATBL.....BLUE



2. REED NOMAD SWIVEL CHAIR

Space efficient combination of a mobile chair and desk, complete with bag and book storage underneath. Mobile and adaptable. Ideal in compact multi functional spaces.

IGCNOMTWOLI..... WHITE BODY, FABRIC SEAT OLIVE



1. BRAY TERTIARY CHAIR

Combining elegant design with functionality and comfort. Long line back support with high density foam makes it the ideal multi-purpose chair. Stackable with optional links available.

IGCBRALG455BLU.....NAVY BLUE
IGCBRALG455CHA.....CHARCOAL



2. ENERVATE CHAIR

Basic padded 4 leg chair.

SYLENEBK.....BLACK
SYLENEBL.....BLUE

AUDITORIUM SEATING



- 4 Seater - W1900 x D510 x H820mm
- 5 Seater - W2350 x D510 x H820mm
- 6 Seater - W2800 x D510 x H820mm

1. ADVENT AUDITORIUM SEATING

Designed specifically for high usage halls and auditoriums with user comfort in mind. Unique design steel frame with individual lift up seats allows units to be nested for compact storage. Available in 4,5 or 6 seat configurations.

IGCAUDIT4SCHA.....4 SEATER CHARCOAL
IGCAUDIT4SBLU.....4 SEATER BLUE
IGCAUDIT5SCHA.....5 SEATER CHARCOAL
IGCAUDIT5SBLU.....5 SEATER BLUE
IGCAUDIT6SCHA.....6 SEATER CHARCOAL
IGCAUDIT6SBLU.....6 SEATER BLUE



- 3 Seater - W1750 x D505 x H460mm
- 4 Seater - W1950 x D505 x H460mm
- 5 Seater - W2400 x D505 x H460mm

2. ROSWELL 3-5 SEATER CHAIR

Roswell beam seats feature robust hi-impact plastic seats and heavy-duty steel framing. With no moving parts Roswell beam seats are a sensible choice for school settings. Matches other units from the comprehensive Roswell range.

IGCROS3SCHA..... 3 SEATER CHARCOAL
IGCROS3SBLK..... 3 SEATER BLACK
IGCROS4SCHA..... 4 SEATER CHARCOAL
IGCROS4SBLK..... 4 SEATER BLACK
IGCROS5SCHA..... 5 SEATER CHARCOAL
IGCROS5SBLK..... 5 SEATER BLACK



3. OTTER CHAIR WITH OPTIONAL ARMSET

Inspired by Arne Jacobsen's 60's classic stacker. Precision plastic shell with a padded upholstered seat and backrest. Optional armrests that can be fitted. Available in Blue or Black fabric.

SYLOTTBK.....BLACK
SYLOTTBL.....BLUE



4. REMKO CHAIR

A robust linking chair with generous padding and a high level of comfort. Very stable. Stackable design. Suitable for multi purpose spaces. W430 x D450 x H460mm.

SYLFSREMBK.....BLACK
SYLFSREMBL.....BLUE

ADULT CHAIRS

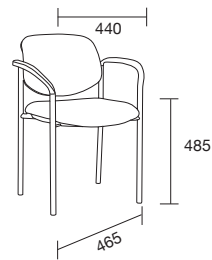

5. WEBSTER CHAIR

Webster is a family of classic visitor chairs which come in a variety of modes: No arms, with arms and with arms & tablet. Classics never date.

- IGCWEBBLK..... NO ARMS BLACK
- IGCWEBBLU..... NO ARMS BLUE
- IGCWEBABLK..... WITH ARMS BLACK
- IGCWEBABLU..... WITH ARMS BLUE

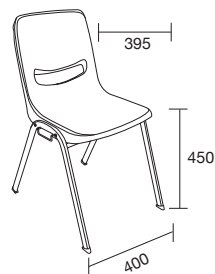

6. TOOTZ CHAIR

Simple, easy clean design, black plastic shell combined with strong steel frame. Linking Clips Included. Compact and space efficient.

SYLFSTOGBK.....BLACK

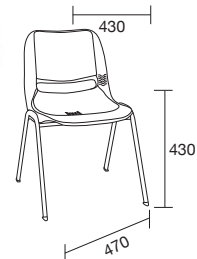

7. TAZZ STACKING CHAIR

Stackable and economical
Surface Material polypropylene.

SYLFSTAZBK.....BLACK

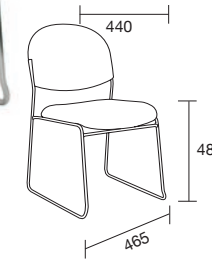

8. YARRA CHAIR

A sturdy, well padded, comfortable multi-purpose rod chair with chrome frame and sled base. Stacks for storage. Stable and strong.

IGCYARCH.....CHARCOAL



10. CRAM SLED VISITOR CHAIR

The high volume stacking chair with minimal storage footprint. Chrome rod frame, Chrome finish. Surface Material PP.

SYLFSCRAVBK.....BLACK
SYLFSCRAVWH.....WHITE

ADULT CHAIRS

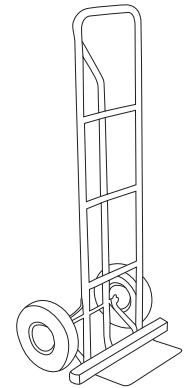

9. SAMSON UTILITY TROLLEY

Ideal for quick and safe transportation of chairs or other items. Easy move pneumatic rubber tyres and strong steel frame. Specifically modified to suit a wide variety of Church furniture chairs.

RGACHAIRTROL.....RED

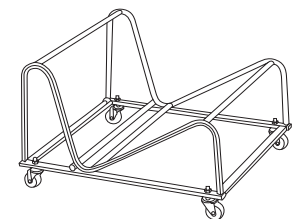

11. CRAM CHAIR TROLLEY

Stores and transports cram chairs.

SYLFSCRATROL.....BLACK

ADULT CHAIRS

CHILDRENS CHAIRS



12. FORTRESS OTTO CHAIR

Commercial grade quality chair with durable lightweight design. Shock proof UV resistant polyethylene for long lasting hassle free use. Frame: folds flat for easy storage. Transport/storage trolleys available.

IGCFORTOTTOCH.....GREY



13. FORTRESS OTTO CHAIR TROLLEY

Sturdy steel frame trolley built to last for easy storage of folding chairs. Holds up to 30 chairs. Width: 1120mm. Depth: 480mm. Height:1900mm.

IGAFORTOTTOTR.....GREY



1. POGO OTTOMAN CHAIR

A unique multi purpose ottoman and stool rolled into one. Swivelling with a convex rocking base and height adjustable seat makes this a must have for any break out, learning or study group area.

ICCOTPOGOGRN.....GREEN
ICCOTPOGOWHT.....WHITE



14. ROMANS SERIES

With it's unique leg over leg design the Romans chair is the fastest and easiest chair available to set up and breakdown large events and venues. Legs interlock in seconds. Tough PP shells suitable for indoor or outdoor.

IGCROMCHON.....(CHARCOAL BACK) PP SEAT HONEY
 IGCROMWHON.....(WHITE BACK) PP SEAT HONEY
 IGCROMCUPSBHON.....(CHARCOAL BACK) FABRIC SEAT & BACK HONEY
 IGCROMWUPSBHON.....(WHITE BACK) FABRIC SEAT & BACK HONEY
 IGCROMCUPSHON.....(CHARCOAL BACK) FABRIC SEAT HONEY
 IGCROMWUPSHON.....(WHITE BACK) FABRIC SEAT HONEY

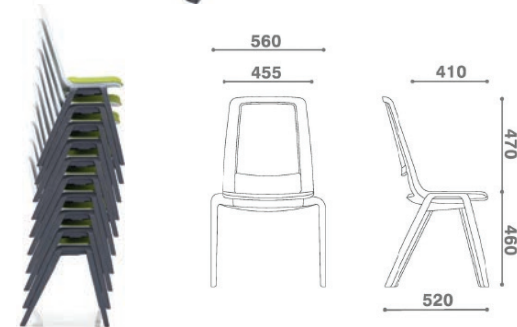

2. BLOOM STOOL

Part of the dynamic seating range, this lightweight, easy clean, versatile stool is like no other. With its rocking side to side base and comfortable seat, the Bloom stool is perfect for libraries, learning groups or any informal meeting area. A variety of sizes to suit everyone from kindy kids to grown ups.

ICCBLOOM310BLU.....310 BLUE
 ICCBLOOM310ORN.....310 ORANGE
 ICCBLOOM310RED.....310 RED
 ICCBLOOM370BLU.....370 BLUE
 ICCBLOOM370ORN.....370 ORANGE
 ICCBLOOM370RED.....370 RED
 ICCBLOOM450BLU.....450 BLUE
 ICCBLOOM450ORN.....450 ORANGE
 ICCBLOOM450RED.....450 RED
 ICCBLOOM520BLU.....520 BLUE
 ICCBLOOM520ORN.....520 ORANGE
 ICCBLOOM520RED.....520 RED



Width: 330 dia.
Heights Available: 310,370, 450 and 520 mm.

CHILDRENS CHAIRS



Single Red:
W450 dia x H450mm

Double Yellow:
W450 x L1030 x H450mm

Triple "V" Blue:
W1030 x L1030 x H450mm

Triple Straight Black:
W450 x L1530 x H450mm

3. LAVA LOUNGE SERIES

With a variety of sizes available and with multiple configurations, the possibilities are endless. Deep padded foam for increased comfort and vibrant colours make any space an attractive work area or casual study space.

ICCLAVLNG1SRED.....	SINGLE RED
ICCLAVLNG2SGRN.....	DOUBLE GREEN
ICCLAVLNG3SVBLU.....	V TRIPLE BLUE*
ICCLAVLNG3SBLK.....	TRIPLE BLACK



CHILDRENS CHAIRS

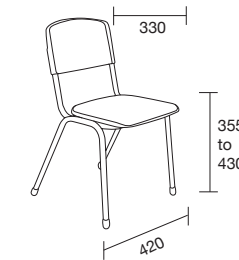

Seat Heights Available:
355, 380, 410 and 430mm

4. REED PRIMARY POSTURE CHAIR

Ergonomically designed chair specifically created with Australian primary school children in mind. Built tough with a sturdy steel 4 leg frame and long life plastics, this chair will last the distance.

ICCPOSLG355DSB.....	355 DEEP SEA BLUE
ICCPOSLG355POR.....	355 PORT
ICCPOSLG380DSB.....	380 DEEP SEA BLUE
ICCPOSLG380POR.....	380 PORT
ICCPOSLG410DSB.....	410 DEEP SEA BLUE
ICCPOSLG410POR.....	410 PORT
ICCPOSLG430DSB.....	430 DEEP SEA BLUE
ICCPOSLG430POR.....	430 PORT

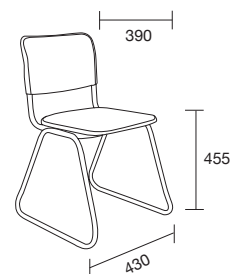
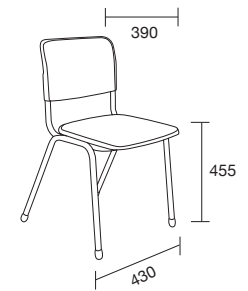

5. REED TERTIARY POSTURE CHAIR

Ergonomically designed chair specifically created with Australian secondary school children in mind. Built tough with a sturdy steel 4 leg frame and long life plastics, this chair will last the distance. Also available as skid base (Shown above).

ICCPOSLG455DSB.....	455 DEEP SEA BLUE MET FRAME
ICCPOSLG455POR.....	455 PORT MET FRAME
ICCPOSLG455PBLK.....	455 BLACK MET FRAME
ICCPOSLGCR455BLK.....	455 BLACK CHROME FRAME
ICCPOSLGCR455DSB.....	455 DEEP SEA BLUE CHROME FRAME
ICCPOSLGCR455POR.....	455 PORT CHROME FRAME
ICCPOSSK455BLK.....	SKID BASE 455 BLACK CHAR MET FRAME
ICCPOSSK455DSB.....	SKID BASE 455 DEEP SEA BLUE CHAR MET FRAME
ICCPOSSK455POR.....	SKID BASE 455 PORT CHAR MET FRAME

CHILDRENS CHAIRS



Size: W820 x D580 x H450mm

6. PUZZLE OTTOMANS

These fun ottomans are a great way to brighten up any room. Available in easy clean vinyl and suited to many different areas such as libraries, break out areas and study groups. Create different layouts to suit your specific areas.

ICGOTTOPUZRED.....	RED
ICGOTTOPUZBLU.....	BLUE
ICGOTTOPUZGRN.....	GREEN
ICGOTTOPUZYL.....	YELLOW



7. TITAN CHAIR

The Titan Chair is an ergonomically designed chair, promoting correct posture. Durable long-lasting design. This one-piece 'high impact' polypropylene chair was designed specifically for schools, from Kindergarten to Year 12. Available with an optional upholstered padded seat. Also available as a stool.



PART NO.	SHELL COLOUR	SEAT HEIGHT (MM)	SIZE MARK	FOOTPRINT WIDTH X DEPTH (MM)	SEAT WIDTH X DEPTH (MM)	BACK HEIGHT X WIDTH (MM)
ICCTITANM2BLU310	BLUE	310	2	360 x 320	360 x 320	360 x 320
ICCTITANM2CHA310	CHARCOAL	310	2	360 x 320	360 x 320	360 x 320
ICCTITANM2GRN310	GREEN	310	2	360 x 320	360 x 320	360 x 320
ICCTITANM2RED310	RED	310	2	360 x 320	360 x 320	360 x 320
ICCTITANM2BLU350	BLUE	350	3	431 x 377	431 x 377	431 x 377
ICCTITANM2CHA350	CHARCOAL	350	3	431 x 377	431 x 377	431 x 377
ICCTITANM2GRN350	GREEN	350	3	431 x 377	431 x 377	431 x 377
ICCTITANM2RED350	RED	350	3	431 x 377	431 x 377	431 x 377
ICCTITANM2BLU380	BLUE	380	4	431 x 377	431 x 377	431 x 377
ICCTITANM2CHA380	CHARCOAL	380	4	431 x 377	431 x 377	431 x 377
ICCTITANM2GRN380	GREEN	380	4	431 x 377	431 x 377	431 x 377
ICCTITANM2RED380	RED	380	4	482 x 470	482 x 470	482 x 470
ICCTITANM2BLU430	BLUE	430	5	482 x 470	482 x 470	482 x 470
ICCTITANM2BUR430	BURGUNDY	430	5	482 x 470	482 x 470	482 x 470
ICCTITANM2CHA430	CHARCOAL	430	5	482 x 470	482 x 470	482 x 470
ICCTITANM2BLU460	BLUE	460	6	487 x 470	487 x 470	487 x 470
ICCTITANM2BUR460	BURGUNDY	460	6	487 x 470	487 x 470	487 x 470
ICCTITANM2CHA460	CHARCOAL	460	6	487 x 470	487 x 470	487 x 470

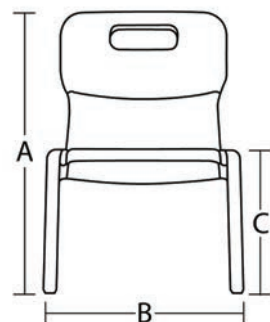

Please note that not all colours are available, please call our sales team for colour options

Titan 1: 1-2 Years Seat Height 260mm Red Yellow Blue Green	Titan 2: 3-5 Years Seat Height 310mm Red Blue Green	Titan 3: 5-7 Years Seat Height 350mm Red Blue Green	Titan 4: 7-9 Years Seat Height 380mm Red Blue Green	Titan 5: 9-13 Years Seat Height 430mm Charcoal Blue Burgundy Red yellow & green are available to order	Titan 6: 13+ Years Seat Height 460mm Charcoal Blue Burgundy



CONFERENCE & EDUCATION OTHER

- Outdoor
- Tables
- Screens



OUTDOOR



1. SUNBENCH 2,3 OR 4 SEATER

These Aluminium powder coated benches are built with functionality and longevity in mind. With a wide seat and available in a 2,3 or 4 seat configuration, they are perfect for any outdoor area including school playgrounds, parks and recreation areas.

IGCSUN2S.....	2-SEATER
IGCSUN3S.....	3-SEATER
IGCSUN4S.....	4-SEATER

DESK



Desk 1200 : W1200 x D750 x H760mm
 Desk 1500 : W1500 x D750 x H760mm

1. REED LEWIS DESK

A classic teachers desk design with powder coated round leg metal frame and laminated top. Including a fixed pedestal with a lockable personal drawer / file and a full length modesty panel, for added peace of mind.

IGTREED1275NH.....	1200
IGTREED1575NH.....	1500

TABLES



3. FORTRESS PLANET FOLDING TABLE

Lightweight yet durable design. Shock-proof UV resistant polyethylene top. Folds flat for easy storage. Commercial grade quality. Storage/transport trolleys available. 10 Year Guarantee. Diameters available: 1524mm or 1800mm. Height: 740mm.

IGTFORPLAN15.....	GREY
IGTFORPLAN18.....	GREY



4. FORTRESS PLANET TABLE TROLLEY

Sturdy steel frame trolley built to last for easy storage of folding tables with secure movement between areas. Size : W830 x L1320 x H1020mm

IGAFORTPLANTR.....	TROLLEY
--------------------	---------

TABLES



1. UPSIDE STACKSTAND LECTERN

This unique sit/stand desk converts from flat fold, to a sitting, then standing position with great ease. Allowing multi function usage with multiple height settings, the Upside is perfect for all classrooms, study areas, libraries and also is a handy lectern. It even has castors to allow quick movement from one area to another.

IGTUPS7051.....	BEACH OVER BLACK AND WHITE
-----------------	----------------------------



2. ORATION LECTERN

Lectern with 2 shelves and a height and angle adjustable top. Powder coated steel fascia. Beech finish top and shelves.

SYLSGMO7106.....	BEACH OVER SILVER
------------------	-------------------



5. FORTRESS REC FOLDING TABLE

Lightweight yet durable design. Shock-proof UV resistant polyethylene top. Folds flat for easy storage. Commercial grade quality. Storage/transport trolleys available. 10 Year Guarantee. W1830 x D760 x H740mm.

IGFORTRECT18.....	FORTRESS REC FOLDING TABLE
-------------------	----------------------------



6. FORTRESS REC TABLE TROLLEY

Sturdy steel frame trolley built to last for easy storage of folding tables with secure movement between areas.

Size : W770 x L1930 x H1150mm

IGAFORTRECTTR.....	TROLLEY
--------------------	---------

TABLES

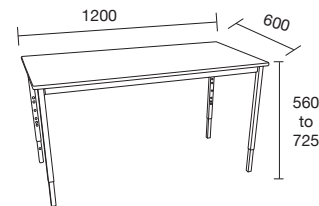
**7. GOULBURN TABLE**

The Goulburn is the ideal multi-purpose table, constructed with a full steel frame giving it longevity and strength. Available as an adjustable height also, with a variety of laminate top colours to suit.

Size : W1200 x D600 x H560-725mm

RCTGACRE1206NOR.....NORDIC TERRA
RCTGACRE1206BLU.....BLUE

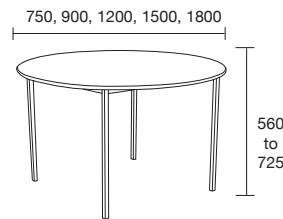
**8. GOULBURN ROUND TABLE**

The Goulburn is the ideal multi-purpose table, constructed with a full steel frame giving it longevity and strength. Available as an adjustable height also, with a variety of laminate top colours to suit.

RCTGACR1200NOR.....NORDIC TERRA
RCTGACR1200BLU.....BLUE

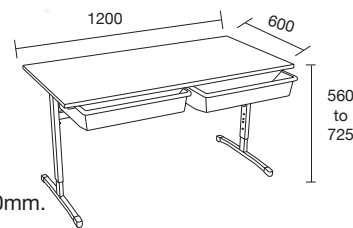

Double desk: W1200xD600mm.
Fixed heights available:
560, 585, 635, 685, 710, 725mm.

9. VICTORIA DOUBLE DESK

The Victoria desk is the leading choice for classroom desk. With its strong height adjustable steel frame and unique feet design, it remains a favoured choice for any classroom environment. Available with a choice of laminate tops and handy tote tray colours, it will add classic style to any classroom.

RCTAVC2S1206NOR.....NORDIC TERRA
RCTAVC2S1206BLU.....BLUE

Single desk: w600 x d600. Fixed
heights available:
560, 585, 635, 685, 710, 725mm

10. VICTORIA SINGLE DESK

The Victoria desk is the leading choice for classroom desk. With its strong height adjustable steel frame and unique feet design, it remains a favoured choice for any classroom environment. Available with a choice of laminate tops and handy tote tray colours, the Victoria desk will add classic style to any classroom.

RCTAVC1S0606NOR.....NORDIC TERRA
RCTAVC1S0606BLU.....BLUE



Standard top sizes:
1500 x 750mm or 1800 x 900mm

11. PARADOX TABLE FRAME

Elegant look combined with quality and strength creates a practical space saving solution. Frame: brushed aluminium and black powder coated frame with strong locking castors. Top: 25mm with ABS edging and a high grade, easy to use flip top mechanism.

SYLPARFRAME1575.....1575
SYLPARFRAME1890.....1890

**13. NESTOR TABLE FRAME**

Professional level folding frame with a clever secret; As the table top is elevated the legs splay out, reducing depth and allowing the tables to stack straight on for storage, rather than offset on a diagonal. Best use of storage space.
Min Top Size: 1450mm x 660mm
Max Top Size: 2400mm x 980mm

SYLFTNESFRAMEBK.....BLACK
SYLFTNESFRAMEWH.....WHITE

TABLES

**12. TRIMFOLD FOLDING FRAME**

The compact economical alternative in mobile folding table frames. The slim desktop frame means that narrow table tops can be used where space is at a premium such as school classrooms.

Suitable Top Size: 1200x600mm

IGTTRFD1206.....GREY

**14. ROBUSTA TABLE FRAME**

The heavy-duty table frame which can accommodate thick and wide tops. A wide stable base with a gas lift assisted top combine with a positive clunk when the top locks in position, think Mercedes door.
Min Top Size: 1700mm x 500mm
Max Top Size: 2400mm x 1200mm

SYLFTROBFRAME.....BLACK

SCREENS

SCREENS

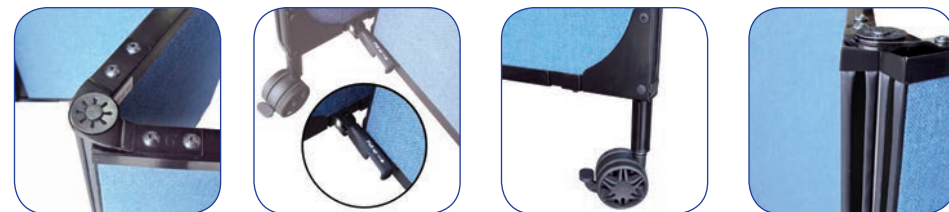
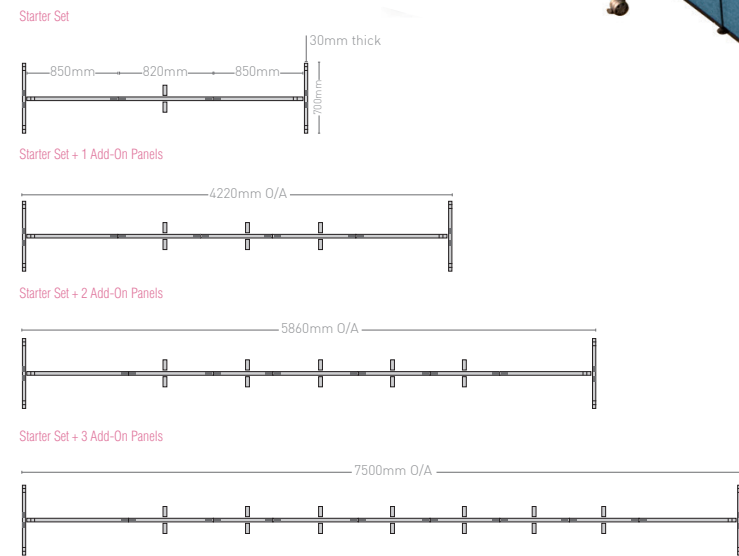
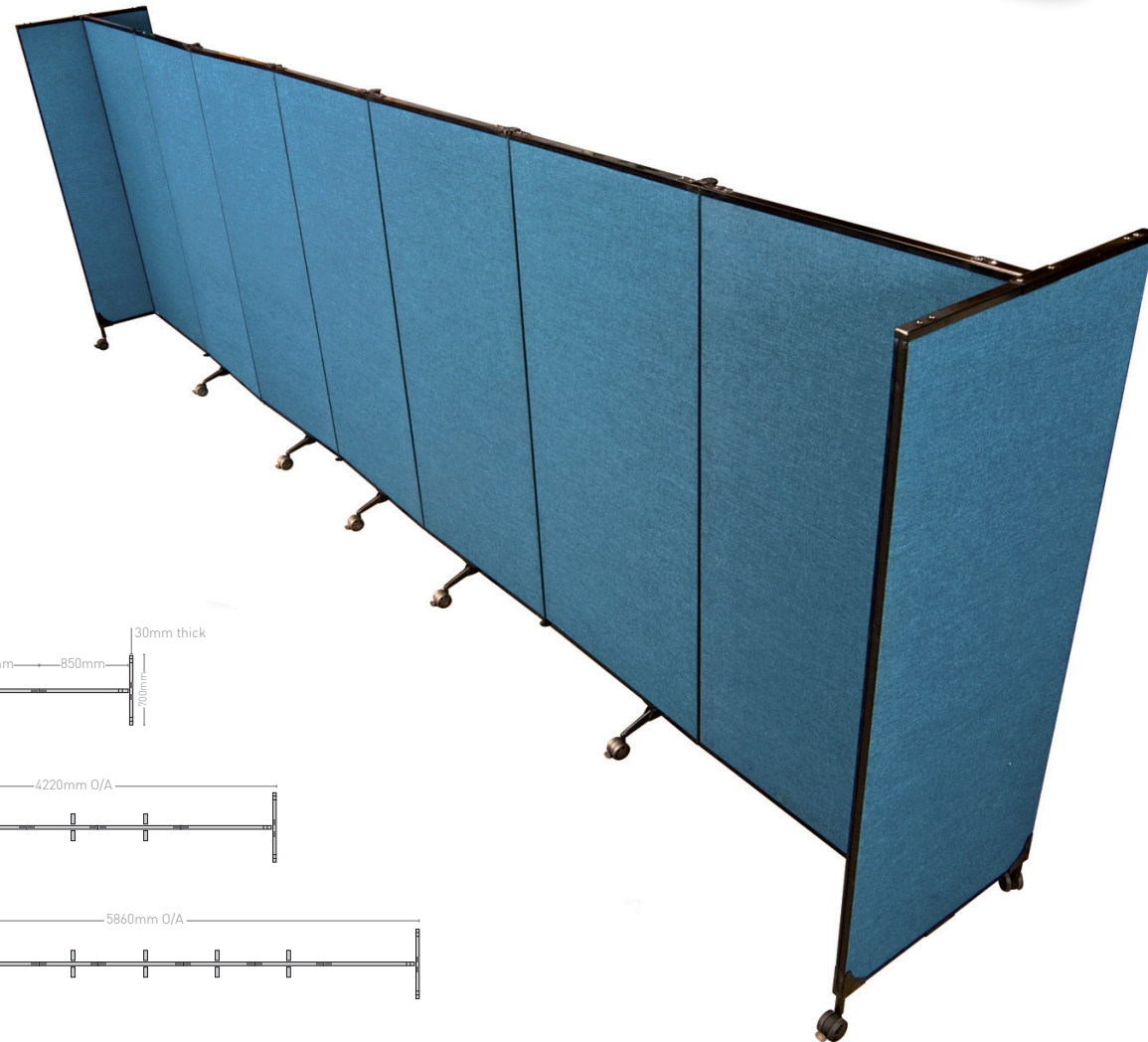

GREAT DIVIDER ADD ON PANELS



CODE	DESCRIPTION	HEIGHT (mm)	SURFACE
SYLGREATDIVS8	GREAT DIVIDER STARTER PANEL	2438	BLUE FABRIC
SYLGREATDIVS6	GREAT DIVIDER STARTER PANEL	1820	BLUE FABRIC
SYLGREATDIVE8	GREAT DIVIDER ADD-ON PANEL	2438	BLUE FABRIC
SYLGREATDIVW8	GREAT DIVIDER ADD-ON PANEL	2438	WHITEBOARD
SYLGREATDIVE6	GREAT DIVIDER ADD-ON PANEL	1820	BLUE FABRIC
SYLGREATDIVW6	GREAT DIVIDER ADD-ON PANEL	1820	WHITEBOARD

TEXTILE AND SURFACE COLOUR OPTION

BLUE

WHITE BOARD



GREAT DIVIDER STARTER SET

Fabric Great Dividers are a brand new rolling wall system for flexibly dividing space and providing effective visual and acoustic barriers. While providing excellent space division, when not being used they simply fold up and roll away in seconds into a compact and storable unit. Great Dividers are a completely modular system allowing you to add panels to create the length of divide you need, up to 7.5 metres long. For even longer configurations units can be ganged together. Great Dividers come in two heights: 1820mm high (6 foot) or 2438mm high (8 foot). While the most popular version is the blue fabric wall, there is also the option of a pair of dry-erase whiteboard wall panels. Great Divider fabric panels are pinnable with a soft substrate, which also aids sound attenuation.

GREAT DIVIDER ADD ON PANELS

Add-on panels come in hinged pairs, with each panel measuring 820mm wide. Like the Starter Sets there are two heights: 1820mm high (6 foot) or 2438mm high (8 foot). The optional dry-erase whiteboard features a high pressure laminate dryerase surface that provides smooth writability, easy erasability and exceptional durability. Up to 3 pairs of Add-on panels can be joined to each Starter Set to create large-format flexible walls, up to 7.5m long. For even longer configurations units can be ganged together. A 4-piece ganging kit link sets together. One set of four is required for each pair of end panels to be joined together.

ADMINISTRATION

- Clerical desk
- Clerical chairs
- Storage
- Education accessories

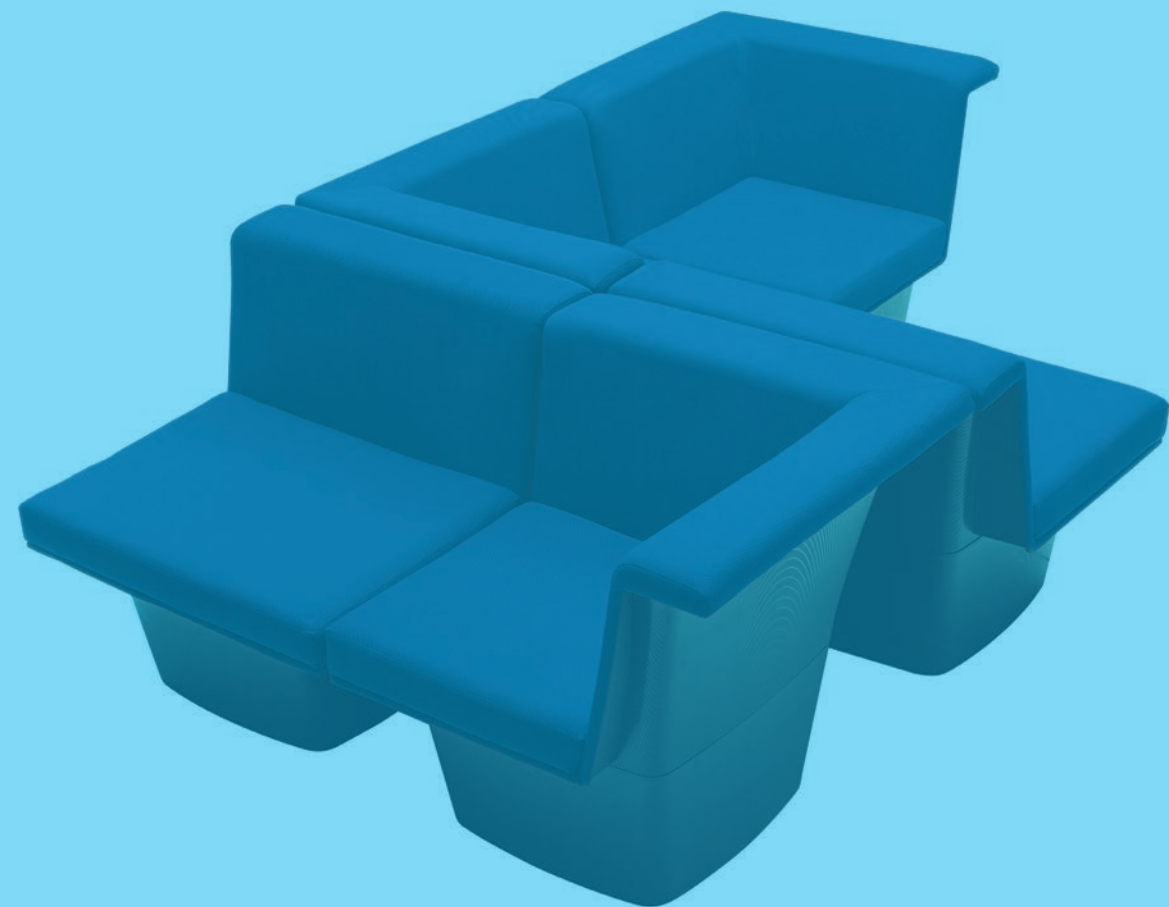

CLERICAL DESK

CLERICAL DESK



1. SONNET SERIES

Reed furniture brings you a new range of contemporary office furniture that is extremely versatile, allowing a multitude of configurations which can be adapted to suit most general office layouts. SONNET combines contemporary production methods with high quality standards, thus producing an exceptional product at a price well below custom manufacture. SONNET features 25mm tops over 18mm sides all finished with colour matched 2mm rigid ABS edging. Cam and dowel assembly makes the product suitable for cartonised "ready to assemble" delivery or if you prefer Sonnet can be assembled prior to shipment.



Clerical desk

Clerical desk

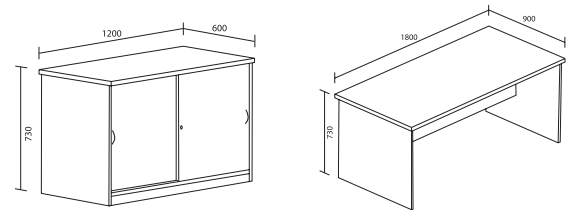
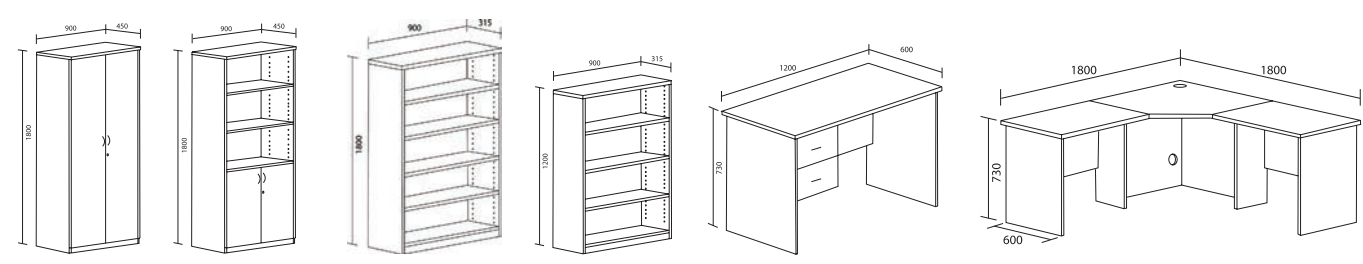

SYLFISBC12A.....	3 SHELVES 1200H
SYLFISBC18A.....	4 SHELVES 1800H
SYLFISCA189FDA.....	FULL DOORS 1800H
SYLFISCA189HA.....	HALF DOORS 1800H
SYLFISCR126A.....	CREDENZA
SYLFISCRH12A.....	HUTCH UNIT
SYLFISCRWS186A.....	CORNER WORKSTATION
SYLFISDKS126A.....	2 DRAWERS
ICCPSSK455POR.....	RECTANGULAR DESK
SYLFISFP1D1FA.....	1 DRAWER AND 1 FILE
SYLFISFP3DA.....	2 DRAWERS
ICCPSSK455POR.....	3 DRAWER
SYLFISMP2D1FLA.....	2 DRAWERS AND 1 FILE WITH LOCK
SYLFISR96A.....	DESK RETURN
SYLFIS2DVF.....	2 DRAWER FILING CABINET
SYLFIS3DVF.....	3 DRAWER FILING CABINET
SYLFIS4DVF.....	4 DRAWER FILING CABINET

CLERICAL DESK

CLERICAL DESK

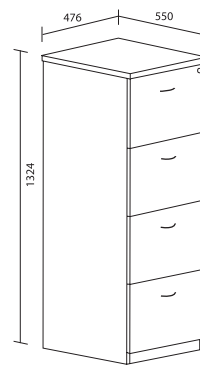
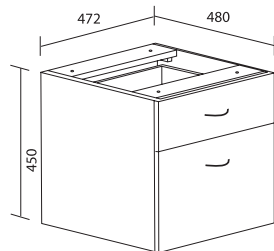
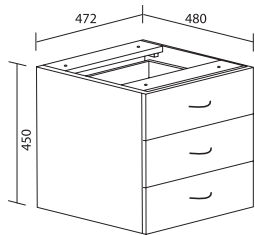
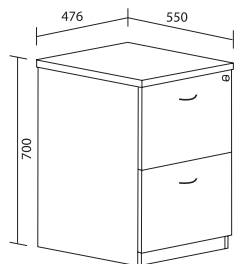

SONNET SERIES
3D Images are suggested configuration to assist users visualise various combinations.

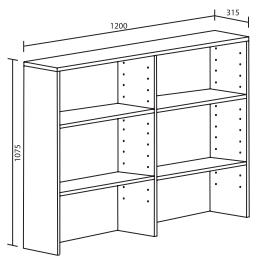
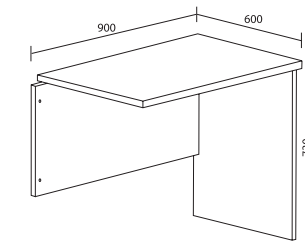
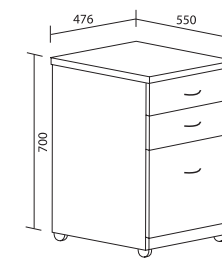
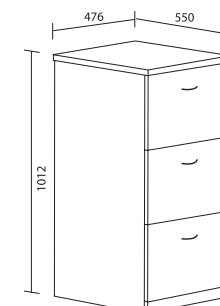

CLERICAL CHAIRS

CLERICAL CHAIRS



Anti-microbial

1. FLOREY HEALTHCARE CHAIR

Easy to clean, antimicrobial furniture designed to prevent the spread of healthcare associated infections. It creates an antimicrobial barrier to bacteria and offers safe and supportive ergonomic design.

ICCFLOABLU460.....ARMCHAIR BLUE
 ICCFLOSBLU460.....SIDECHAIR BLUE
 ICCFLOLINK.....LINKING CLIPS



2. AMSTERDAM CHAIR

Combining elegant design, functionality and comfort. With its extra comfortable all round padding and built in arms, the chair is perfect for any foyer, waiting room, aged care, or reception area.

IGCAMSRD.....RED
 IGCAMSBLU.....BLUE



3. TAMBO SINGLE AND DOUBLE CHAIR

Designed for comfort and durability, the Tambo skid is the ultimate reception chair. With standard Chrome frame and available in standard red, black or charcoal fabrics, the Tambo will make a stylish statement in any area.

Double: W1120 x D560 x H430
 Single: W550 x D500mm.

IGCTAMBO1430BLK.....BLACK
 IGCTAMBO1430CHA.....CHARCOAL
 IGCTAMBO2430BLK.....BLACK
 IGCTAMBO2430CHA.....CHARCOAL



4. HOTHAM SERIES

Ergonomic height adjustable mid back chair. Independent seat and back-tilt. Back height adjustment. Deep pile high density molded foam. Nylon base. Optional height and splay adjustable arms available. Drafting chair model available.

IGGHOTMUPHCHA.....MID BACK CHARCOAL
 IGGHOTMUPHBLU.....MID BACK NAVY
 ICGHOTHUPHCHA.....HIGH BACK CHARCOAL
 ICGHOTHUPHBLU.....HIGH BACK NAVY

HOTHAM - HIGH BACK	
Seat	D:410mm W:495mm
Back	H:500-575mm W:440mm
Seat Height	Min:430mm Max:550mm
Surface Material	Fabric

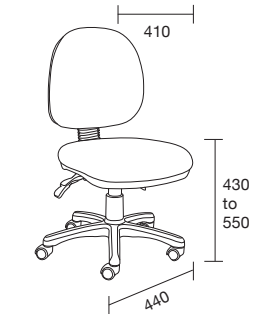

HOTHAM - MID BACK	
Seat	D:410mm W:495mm
Back	H:420-495mm W:440mm
Seat Height	Min:430mm Max:550mm
Surface Material	Fabric



5. HESTON HI BACK CHAIR

GENUINE BONDED LEATHER EXECUTIVE CHAIR. A high square back chair upholstered in genuine bonded leather will look great for years to come, yet at a fraction of the price of similar looking chairs. centre tilt mechanism lockable in the upright position, tilt tension, gas lift height adjustment.

SYLFSHESHBBK.....HI BACK BLACK



HESTON - HIGH BACK	
Seat	D:460mm W:490mm
Back	H:660mm W:490mm
Seat Height	Min:380mm Max:500mm
Surface Material	Bonded leather



6. MOTIF SYNCHRON CHAIR

A basic chair which understands that to look great you don't need to be expensive. While the looks are hot the fabric is guaranteed not to ignite as this chair passes the strict California Code for fabric burn tests. With metal trimmed base.

SYLMOTSYNMBBK.....MID BACK BLACK

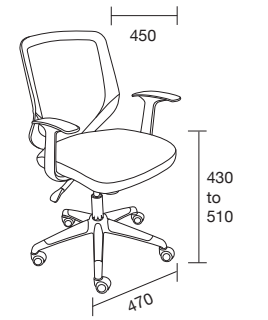

MOTIF - MID BACK	
Seat	D:450mm W:490mm
Back	H:485mm W:470mm
Seat Height	Min:410mm Max:530mm
Surface Material	Fabric back & Mesh

CLERICAL CHAIRS

CLERICAL CHAIRS



BIG BOY - MID BACK	
Seat	D:500mm W:570mm
Back	H:650mm W:570mm
Seat Height	Min:480mm Max:560mm
Surface Material	Premium Leather

BIG BOY - VISITOR	
Seat	D:500mm W:550mm
Back	H:650mm W:550mm
Seat Height	440mm
Surface Material	Premium Leather

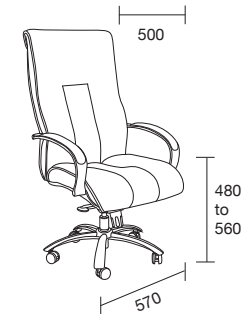

BIG BOY - HI BACK	
Seat	D:500mm W:570mm
Back	H:780mm W:570mm
Seat Height	Min:480mm Max:560mm
Surface Material	Premium Leather

Colour options	
Stock Colours	Black

7. BIG BOY SERIES

Full-sized chairs for the heavy hitters. Sink into the puckered real leather faced upholstery. Lean back and lock while you ponder the world and how to conquer it. Leather faced padded arms and polished chromed metal base and arms exude authority.

- SYLFSBIGHBBK.....HI BACK BLACK
- SYLFSBIGMBBK.....MID BACK BLACK
- SYLFSBIGVBK.....VISITOR BLACK



DEUCE - VISITOR	
Seat	D:480mm W:480mm
Back	H:495mm W:445mm
Seat Height	445mm
Surface Material	Mesh back & Synthetic Leather

DEUCE - MID BACK	
Seat	D:480mm W:480mm
Back	H:495mm W:445mm
Seat Height	Min:390mm Max:510mm
Surface Material	Mesh Back & Synthetic Leather

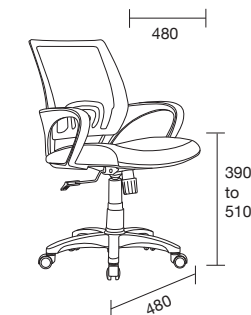

Colour options	
Stock Colours	Black, Lime, Blue

8. DEUCE SERIES

Ultra Modern Meeting room chair combines unique design with exceptional comfort. Base: Nylon 5 star base with attractive dual coloured 'soft-wheel' castors. Tilt & lock action with adjustable tension control. Available with a black seat and lime, blue or black mesh backs. Breathtaking mesh colours and a lumbar support offering hours of comfortable use. The Deuce is your economical office chair choice. Simple, compact and trendy. Very stylish as a meeting room chair.

- SYLDEUCEBLK.....GAS LIFT BLACK
- SYLDEUCEBLUE.....GAS LIFT BLUE
- SYLDEUCELIME.....GAS LIFT LIME
- SYLFSDEUVBK.....VISITOR BLACK
- SYLFSDEUVBL.....VISITOR BLUE
- SYLFSDEUULM.....VISITOR LIME

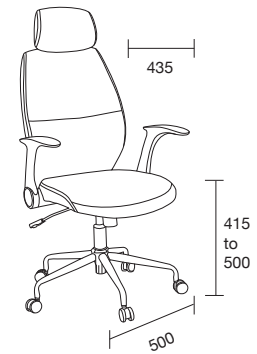

MODENA - VISITOR	
Seat	D:435mm W:500mm
Back	H:550mm W:490mm
Seat Height	440mm
Surface Material	Synthetic Leather

MODENA - MID BACK	
Seat	D:435mm W:500mm
Back	H:550mm W:490mm
Seat Height	Min:415mm Max:500mm
Surface Material	Synthetic Leather

MODENA - HI BACK	
Seat	D:435mm W:500mm
Headrest	H:185mm W:295mm
Back	H:550mm W:490mm
Seat Height	Min:415mm Max:500mm
Surface Material	Synthetic Leather

Colour options	
Stock Colours	Black

9. MODENA SERIES

Modena is a slim, organically-shaped chair with a trick up its sleeve. All models feature fold back arms. This solves the age-old debate by allowing users to pull up close to the desk for writing or keyboard entry or fold the arms down for rest and comfort. Affordable intelligence.

- SYLMODHBBK.....HI BACK BLACK
- SYLMODMBBK.....MID BACK BLACK
- SYLMODVBK.....VISITOR BLACK

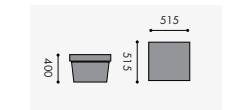
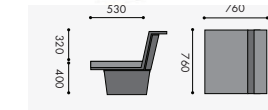
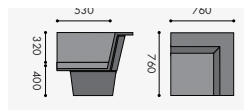

10. MODULUM SERIES

Modular Lounge System combines in many configurations to create sizes and shapes to suit any workspace or breakout area.



- IGCMODCNBLK.....CORNER BLACK
- IGCMODLINBLK.....LINEAR BLACK
- IGCMODTUFBLK.....POUF BLACK
- IGCMODCNBLU.....CORNER BLUE
- IGCMODLINBLU.....LINEAR BLUE
- IGCMODTUFBLU.....POUF BLUE
- IGCMODCOFWAL.....COFFEE TABLE WALNUT

STORAGE

EDUCATION ACCESSORIES

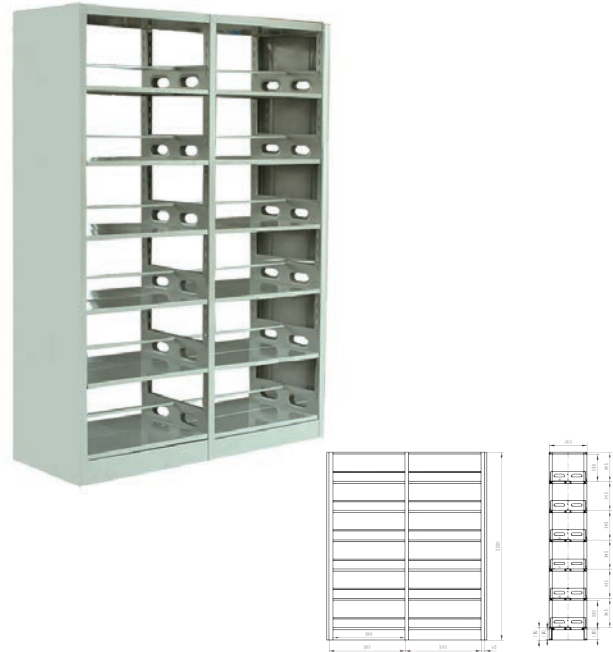

1. LIBRARY SHELF

With steel construction, adjustable height shelves and available with or without castors, Reed furniture can design a solution to suit your individual needs.

IGTSAKLSDBGY.....DOUBLE GREY



Size: W360 x D800 x H900.
Height Floor to Bottom Shelf: 170mm.
Height Floor to Top Shelf: 690mm

2. SAKURA BOOK TROLLEY

A multi purpose trolley suitable for many different applications. With rubber castors and easy grab top handles, the Sakura trolley is perfect for libraries, school or any administration area. Available in grey

IGTSAKTRYGY.....GREY



1. REED WASTE BIN

Functional angled design with waste securing ring make it ideal for all office or general use areas.

ICCREEDWSTBNG.....GREY



2. REED WASTE BIN SEPARATOR

Ideal addition to waste bin allows easy disposal of Eco waste and quicker cleaning times.

ICCREEDWSTBNS.....BLACK



3. SAKURA STORAGE CABINET

Designed for long life use and flexibility, the Sakura cabinet is perfect for all administration areas. It includes multi adjustable shelves and flush locking mechanism. Available in Grey.

Dimensions: W900 x D400 x H1850mm

IGTSAKSC1850GT.....1850 GREY
IGTSAKSC900GY.....900 GREY



2 Drawer: W460 x D620 x H725mm
3 Drawer: W460 x D620 x H1025mm
4 Drawer: W460 x D620 x H1330mm

4. SAKURA 2 / 3 / 4 DRAWER

Part of the Sakura range of Office products, the filing cabinets are designed for any administration or office area. All feature high backs to prevent files jamming and anti tilt for safe operation. Available in grey.

IGTSAKFC2DGY.....2 DRAWER GREY
IGTSAKFC3DGY.....3 DRAWER GREY
IGTSAKSC900GY.....4 DRAWER GREY



3. REED STEP STOOL

With its secure anti slide rubber base and castors that lock in place when standing on the stool, the Reed step stool is perfect for all admin, library, classroom areas and for general purpose usage.

ICCREEDSTPSTLR.....RED



4. LODEN PLATFORM TROLLEY

With a fold down handle and easy manoeuvre heavy duty castors, the trolley has a maximum weight capacity of 80 kgs, making it ideal for all general use purposes.

ICCREEDPFTR.....TROLLEY

EDUCATION ACCESSORIES

EDUCATION ACCESSORIES

Warranty



All parts & workmanship are covered for 10 years subject to warranty registration. Excludes fabric wear.

Colour options

Stock Colours

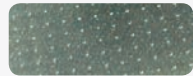

Translucent

5. CHAIR MAT

Guaranteed against cracking & crazing. Suitable for commercial carpeted floors. Protects carpets & chairs.

Colour: Translucent

Available in two sizes: W900 x D1200 and W1100 x D1300.

SYLCM0912.....900 X 1200
SYLCM1113.....1100 X 1300

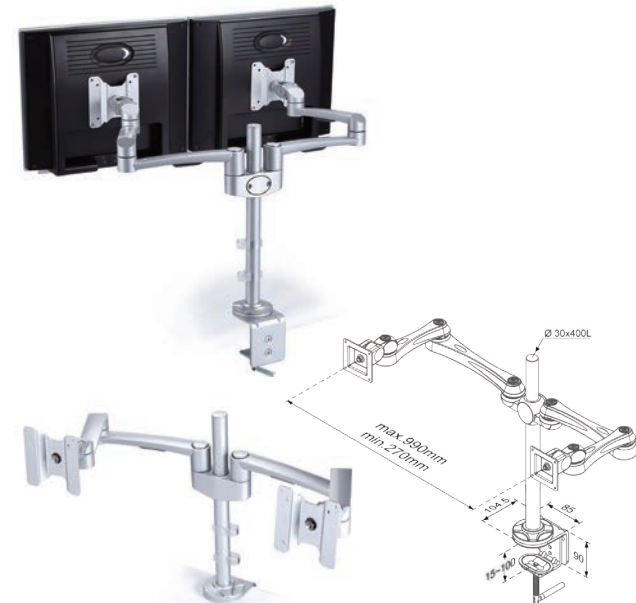

6. DOUBLE MONITOR ARM

Double mount type arms allows users to mount 2 monitors. This is ideal for multi screen work setup. The ultimate mounting solution for flat panel display. For use in offices, schools, point of sale, industrial, medical needs. Flexible combinations meets the needs of various environments. Height, depth & angle adjustment.

SYLAEMMSFA201.....SINGLE



Suitable for low to medium pile carpets, 6-12mm including underlay



7. SINGLE MONITOR ARM

Single monitor arm is designed to give the user freedom of movement around his or her work space. The ultimate mounting solution for flat panel display. For use in offices, schools, point of sale, industrial, medical needs. Flexible combinations meets the needs of various environments. Height, depth & angle adjustment.

SYLAEMMSFA215.....DOUBLE



8. REED TWIN LINE CABLE PIPE

A must have accessory for all offices. The Reed Twin Line Cable Tray keeps cables secure and reduces trip hazards. It's also easy to fit to most desks or tables.

ICCREEDTWCBL.....CABLE PIPE



Overall Dimensions

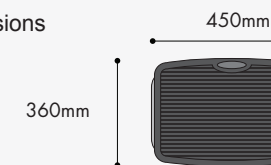

10. FOOTREST TILT ONLY

High grade moulded plastic. Tilt adjustable only. Black colour. Colour: Black. Size: W450 x D360mm.

SYLFOOTDBK.....BLACK

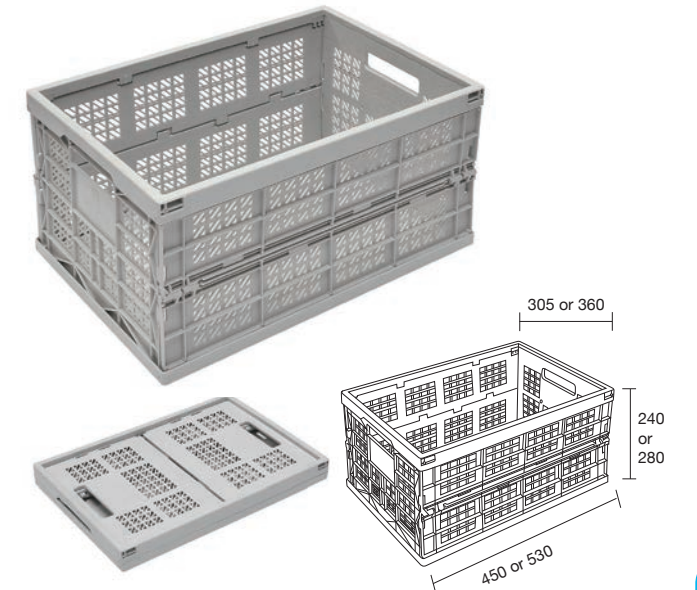

Small: W450 x D305 x H240mm
Large: W530 x D360 x H280mm

9. QUICK FOLD BASKET

These Quick Fold Baskets have many applications from the art room, administration areas to libraries. It includes carry handles and can be stored easily as it folds down flat. You can even keep it as a useful back up in your car boot. Available in 2 sizes.

ICCFBASKETSM.....SMALL
ICCFBASKETLG.....LARGE



Overall Dimensions

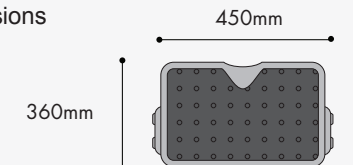

11. FOOTREST HEIGHT / TILT

High Grade moulded plastic. Height & tilt adjustable. Platinum colour premium rubber surface with removable rubber surface. Size: W450 x D360mm.

SYLFOOTHPL.....PLATINUM