

NARWAL™

User Manual

Narwal Freo X Ultra Robot Vacuum and Mop

Dear users:

Thank you for purchasing Narwal products. To access comprehensive support from Narwal, you are recommended to read carefully the manual and illustrations before using the product. Please keep the manual properly.

The manual may be updated from time to time based on product updates and user feedback. Please scan the QR code below to browse the official website and view the latest version.

In case of any problem in using the product, please contact Narwal after-sales customer service through the following ways:

Customer service email:

support@narwal.com(North America)
support.eu@global.narwal.com(Germany)
support.it@global.narwal.com(Italy)
support.jp@narwal.com(Japan)
support.fr@global.narwal.com(France)
support.kr@narwal.com(South Korea)
support.es@global.narwal.com(Spain)

*For other countries, please refer to the after-sales contact information provided by your local vendors

We wish you a pleasant experience!



WWW.NARWAL.COM



Electronic user manual
電子取扱説明書
전자 설명서
Elektronisches Benutzerhandbuch
Manuale Utente Elettronico
Manual de usuario electrónico
Manuel d'utilisation électronique
Электронное руководство пользователя
คู่มืออิเล็กทรอนิกส์
Sổ tay điện tử
מדריך אלקטרוני
Elektronik Kilavuz
Instrukcja elektroniczna

CONTENTS

en	02
de	09
it	16
fr	23
es	30
ru	37
tr	44
pl	51

1. Product At A Glance

1.1 Check list

Main parts

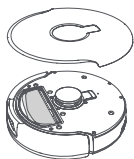

Robot × 1 (including disposable dust bag × 1, mopping module × 2)

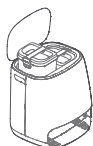

Base station × 1 (including cleaning base × 1, cleaning tray × 1, clean water tank × 1, dirty water tank × 1)

Accessories

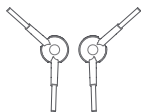

Side brush × 2

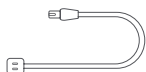

Power cord × 1



Dedicated detergent × 1

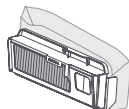

Disposable Dust Bag × 2



Dust bin × 1

1.2 Robot

Front (top cover closed)

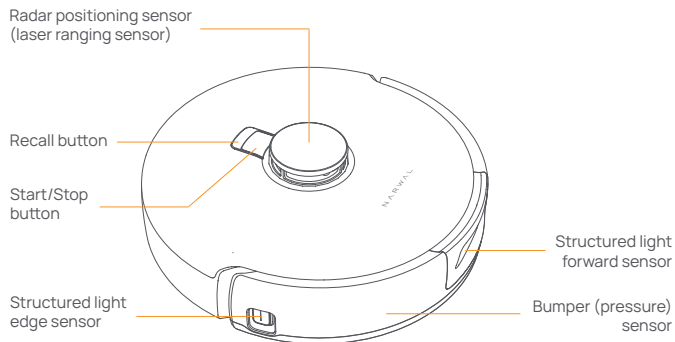

Front (top cover open)

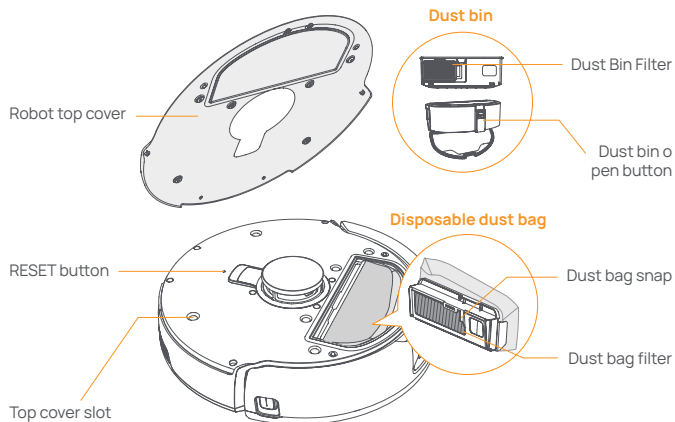

Robot bottom

Infrared ranging and anti-drop sensor ×5

Ultrasonic carpet sensor

Nameplate (S/N included)

Cyclonic deflector tangle-free roller brush

Mopping module ×1

Mop pad ×2

Mop base ×2

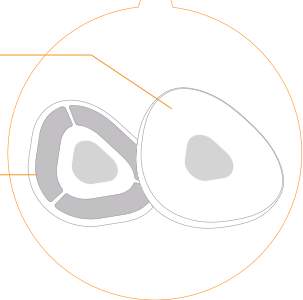
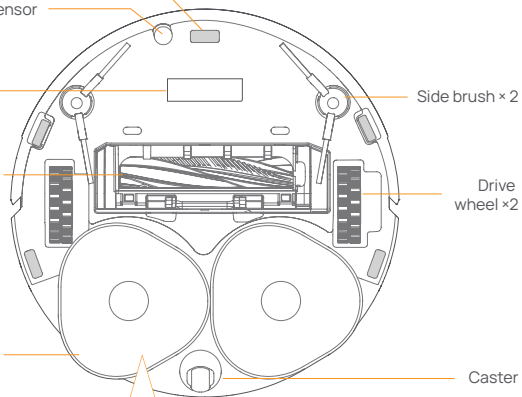

1.3 Base station

Front (lid closed)

Touch panel

Free Mind On/Off button

Recall/Exit button

Base Station indicator

Child Lock indicator

Mop washing/drying button

Start/Stop button

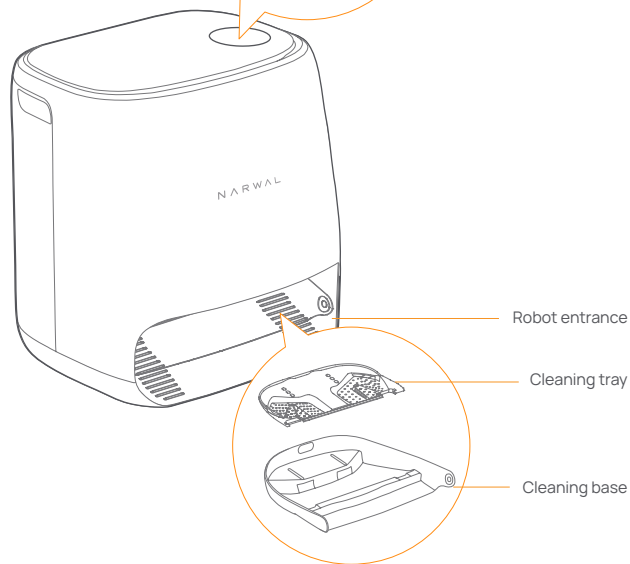

Robot entrance

Cleaning tray

Cleaning base

Front (lid open)



Back

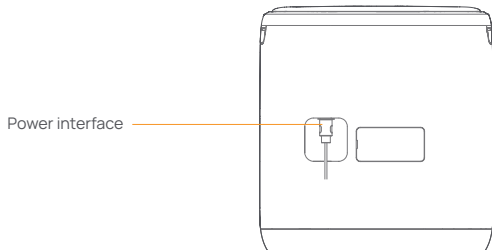

1.4 Buttons and indicators

Robot buttons

Button	Action	Function
Start/Stop	Short press	Start/pause/resume current task
	Press and hold for 2s	Power on/off
Recall	Short press	Return to the base station
	Short press	Enter the pairing mode
Reset	Press and hold for 5s	Unbind the account and clear user data
	Press and hold for 10s	Restore factory settings

Base station buttons

Button	Action	Function
	Short press	Start/pause/resume current task
	Press and hold for 2s during a task	End current task
	Short press	(Cancel) Recall/Exit
	Press and hold for 2s	turn on child lock
	Press and hold for 2s	Child Lock off
	Short press	Turn On/Off Free Mind
	Short press	Start/cancel mop washing and drying
	Press and hold for 10s	Refill/discharge self-check
		Press and hold for 2s
	Press and hold for 2s	Restart mapping

Robot & base station indicators

Indicator	Robot indicator	Base Station indicator	Meaning
Off	✓	✓	Robot is turned off Base station shutdown or touch panel in AOD. Touch to wake up
Steady white	✓	✓	Base station and robot on standby
Breathing white	✓	✓	Base station and robot idle
Steady blue	✓	✓	Cleaning underway
Breathing blue	✓	✓	Cleaning paused
Steady purple	✓	✓	Disinfection underway
Breathing purple	✓	✓	Disinfection paused
Breathing red	✓	✓	Base station or robot abnormal or base station and robot disconnected
Breathing orange	✓	✓	Pairing or update underway
Colorful meteor light	✗	✓	Waking up the base station

2. 2. Get Ready Before Use

Install the side brushes

Press side brushes into the slots as indicated by color until they click into place.

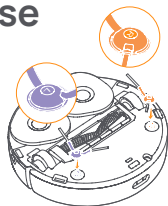

Remove the anti-collision foam

Open the robot top cover and remove the anti-collision foam.

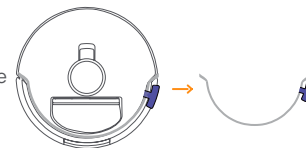

Place the base station

Plug the power cord into the socket on the back of the base station and leave an open space of at least 1.0m in front of the base station for the robot to enter and leave the base station.

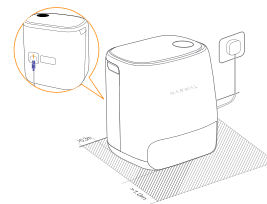

Note: If the base station is placed tilted or there are table legs, curtains, and ornaments around, the robot's obstacle avoidance function may be triggered, affecting its entry and exit.

Place dedicated detergent

- Turn the detergent upside down (DO NOT remove the cap) and insert it into the slot. The dedicated detergent bottle is properly in place when it is fixed without tipping over.
- You can set in the App whether to add the detergent automatically when mopping.

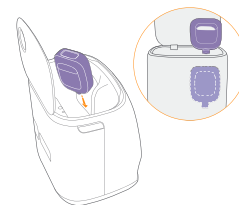

Add clean water

Before mopping, add water to the clean water tank for mop washing.

- Lift up the base station lid. Take out the clean water tank, snap it open and fill it with clean water (DO NOT exceed the MAX water level mark).
- Snap the tank shut and put the water tank back into the base station.



Note: DO NOT add any third-party detergents or disinfectants into the clean water tank to avoid product damage.

Startup settings

Push the robot into the base station with side brushes facing outward. The base station will beep once to indicate that charging is successful and the robot will switch itself on and broadcast the message.



Connect and bind the robot in the App

Scan the QR code to download the Narwal Freo App, tap "Add Device" and select the model in the App, and follow the instructions for connecting and binding the robot.

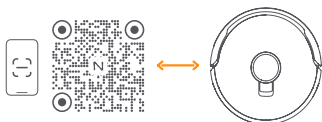

3. How to Use

Before using the robot, please make sure you have finished the installation and base station setup in Chapter 2.

3.1 Organize the home environment

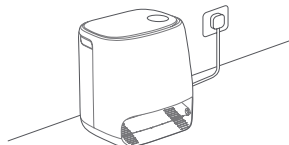

A. Put away the clutter on the floor, e.g. scattered cables, rags, slippers, clothes and books.

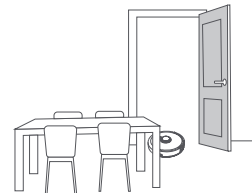

B. Open the doors of the rooms to be cleaned and arrange the furniture to leave as much space as possible for cleaning.

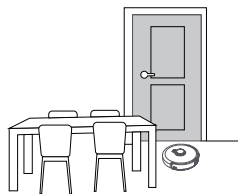

C. Leave other doors closed and install the fence to prevent the robot from entering elevated or low areas.

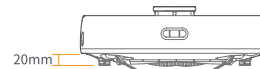

D. The maximum obstacle crossing height is 20mm and the robot cannot enter rooms with a threshold height of over 20mm. You can purchase Narwal Threshold Ramp to help the robot climb over and around obstacles more efficiently.

E. DO NOT stand in front of the robot, on the threshold or in narrow aisles to avoid omission.



3.2 Mapping

Before cleaning a new home, the robot needs to explore the environment and create a map. Before first-time cleaning, you can trigger mapping by short pressing the ▶️ **[Start/Stop]** button on the robot or tapping "Start Mapping" in the App.

Note:

1. Once a map is created, it can be edited in the App.
2. Please do not move the base station after a map is created, or you have to restart mapping. If large furniture in your home is rearranged, it is recommended to create a new map.

3.3 Cleaning

Select cleaning modes

The product comes with four built-in cleaning modes: Vacuum, Mop, Vacuum and Mop, and Vacuum then Mop. You can select and adjust parameters like cleaning cycles, suction, and mop humidity for each mode in the App.

Set Freo Mind

The Freo Mind is an intelligent cleaning assistant. When the Freo Mind is enabled, the robot can:

- set cleaning parameters based on the environmental data collected by sensors;
- enhance edge-to-edge cleaning.

You can enable the Freo Mind in two ways:

- Select the Freo Mind in the cleaning modes in the App;
- Short press 🏠 **[Freo Mind On/Off]** button on the base station. When the indicator turns on, it means the Freo Mind is on.

Start cleaning task

You can start the robot for cleaning in the following three ways:

- Tap ▶️ **[Start Cleaning]** in the App
 - Short press the ▶️ **[Start/Stop]** button on the robot and the robot will activate the Vacuum Mode by default;
 - Short press the ▶️ **[Start/Stop]** button on the base station to start cleaning. The robot will activate the Vacuum and Mop Mode by default;
- Note: You can adjust the cleaning mode and set more cleaning parameters in the App.

Pause/resume current task

You can pause/resume current task in three ways:

- Tap ▶️ **[Pause]** / ⏪ **[Resume]** in the App;
- Short press the ▶️ **[Start/Stop]** button on the robot;
- Short press the ▶️ **[Start/Stop]** button on the base station.

Mop washing

If the robot is set for multiple mopping runs or the area for cleaning is large, the robot will automatically return to the base station for mop washing. The number of mopping runs and returns can be modified in the App before cleaning starts, and cannot be modified during the current cleaning task.

End current task

The robot will navigate itself back to the base station when cleaning ends. You can view the current cleaning report in the App.

You can manually end the task in the following three ways:

- Press and hold ⏪ **[Finish]** for 2s in the App;
- Short press the 🏠 **[Recall]** button on the robot;
- Short press the 🏠 **[Home]** **[Recall]** button or press and hold the ▶️ **[Start/Stop]** button on the base station for 2s.

Drying and disinfection

After the last mopping run, the robot will return to the base station for mop washing and drying. The drying time can be modified in the App.

You can also start mop washing and drying manually in the following two ways:

- Tap  【Mop Washing & Drying】 in the App;
- Short press  【Mop Washing & Drying】 on the base station.

4. Parameters

4.1 Specifications

Robot	Base station
Dimensions: 350*350*107 mm	Dimensions: 415*370*434mm
Color: White	Color: White
Weight: ~4.25kg	Weight: ~8.5kg
Wi-Fi	Rated input: 100-240V~
Protocol: IEEE 802.11b/g/n	Rated output: 20V --- 3.0A
Frequency Range: 2412~2472MHz	Rated frequency: 50-60Hz
Max. Transmitter Power (EIRP): ≤20dBm	Rated power: 72W
Bluetooth	Bluetooth
Protocol: BLE 5.0	Protocol: BLE 5.0
Frequency Range: 2402-2480MHz	Frequency Range: 2402-2480MHz
Max. Transmitter Power (EIRP): ≤10dBm	Max. Transmitter Power (EIRP): ≤10dBm

Battery (Robot)	
Battery Type	Rechargeable Li-ion Battery
Battery Pack Quantity Per Pack	1 pcs
Quantity of Battery Cells Per Battery Pack	8 pcs
Rated Capacity, Rated Energy	5000mAh, 72Wh
Nominal Voltage	14.4V ---