

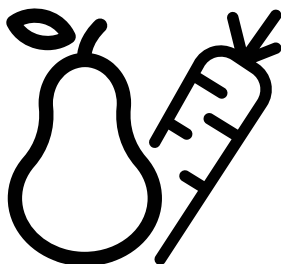

## Refrigerator

User Manual



GNE480E20FX-GNE480E20FDZX-GNE480E20ZB-GNE480IC3VPX  
GNE480EC3DVX



**EN**  
58 0589 0000/AL

## Please read this user manual first!

Dear Valued Customer,

We hope that your product, which has been produced in modern plants and checked under the most meticulous quality control procedures, will provide you an effective service.





### The user manual will help you use the product in a fast and safe way.





- Make sure you read the safety instructions.
- Keep the manual in an easily accessible place as you may need it later.
- Read the other documents given with the product.
- The manufacturer reserves the right to make modifications on the product.

Remember that this user manual is also applicable for several other models.

### Explanation of symbols

#### The following symbols are used along this user manual:

	Important information or useful hints.
	Risk of injury and damage to property.
	Risk of electric shock.
	Packaging materials of the product are manufactured from recyclable materials in accordance with our National Environment Regulations.

 <b>INFORMATION</b>	
 	.The model information as stored in the product data base can be reached by entering following website and searching for your model identifier (*) found on energy label.
SUPPLIER'S NAME → MODEL IDENTIFIER → (*)	<a href="https://eprel.ec.europa.eu/">https://eprel.ec.europa.eu/</a>
	

# Contents

## **1 Important Instructions Regarding Safety and Environment 3**

- 1.1. General Safety . . . . . 3
- 1.1.1 Hydrocarbon (HC) Warning . . . . . 5
- 1.1.2 For Products with a Water Dispenser/Ice Machine 5
- 1.2. Intended Use . . . . . 5
- 1.3. Children's Safety . . . . . 6
- 1.4. Compliance with the WEEE Directive and Disposing the Waste Product: . . . . . 6
- 1.5. Compliance with the RoHS Directive: . . . . . 6
- 1.6. Packaging Information . . . . . 6

## **2 Your appliance 7**

## **3 Installation 8**

- 3.1. Installing the plastic wedges . . . . . 8
- 3.2. Adjusting the feet . . . . . 9
- 3.3. Electrical connection . . . . . 9

## **4 Preparation 10**

- 4.1. Things to be done for energy saving . . . . . 10
- 4.2. Initial use . . . . . 10

## **5 Operating the product 11**

- 5.1. Indicator panel . . . . . 11
- 5.2. Indicator panel . . . . . 16
- 5.3. Indicator panel . . . . . 20
- 5.4. Ice machine . . . . . 23
- 5.5. Icematic . . . . . 23
- 5.6. Ice container . . . . . 23
- 5.7. Blue light . . . . . 24
- 5.8. Deodorising Module . . . . . 24  
(FreshGuard) . . . . . 24
- 5.9. Ionizer . . . . . 24
- 5.10. Chiller compartment . . . . . 25
- 5.11. Crisper . . . . . 25
- 5.12. Movable Middle Section . . . . . 25
- 5.13. Using the water dispenser . . . . . 25
- 5.14. Filling the water dispenser's tank . . . . . 26
- 5.15. Cleaning the water tank . . . . . 27
- 5.16. Drip tray . . . . . 27
- 5.17. Everfresh (Humidity-controlled crisper) . . . . . 28
- 5.18. For HarvestFresh . . . . . 28
- 5.19. Freezing fresh food . . . . . 29
- 5.20. Recommendations for preserving the frozen food 30
- 5.21. Deep-freeze information . . . . . 30
- 5.22. Placing the food . . . . . 30
- 5.23. Door open warning . . . . . 30
- 5.24. Illumination lamp . . . . . 30

## **6 Care and Cleaning 31**

- 6.1. Avoiding Bad Odours . . . . . 31
- 6.2. Protection of plastic surfaces . . . . . 31
- 6.3. Cleaning the Inner Surface . . . . . 31
- 6.4. Stainless Steel Outer Surfaces . . . . . 31

## **6 Care and Cleaning 32**





- 6.5. Cleaning Products with Glass Doors . . . . . 32

## **7 Troubleshooting 33**

# 1 Important Instructions Regarding Safety and Environment

This chapter contains safety information that will help you avoid the risk personal injury or property damage. Failure to follow these instructions shall render any product warranty void.

## Intended use

	<b>WARNING:</b> Keep ventilation openings, in the appliance enclosure or in the built-in structure, clear of obstruction.
	<b>WARNING:</b> Do not use mechanical devices or other means to accelerate the defrosting process, other than those recommended by the manufacturer.
	<b>WARNING:</b> Do not damage the refrigerant circuit.
	<b>WARNING:</b> Do not use electrical appliances inside the food storage compartments of the appliance, unless they are of the type recommended by the manufacturer.

## 1.1. General Safety

- Persons with physical, sensory or mental disabilities; persons who lack experience and information and children should not approach, enter or play with the product.
- Failure to follow the instructions and uncontrolled use of the product lead to dangerous results!
- Unplug the product if you encounter a failure during use.

- If the product malfunctions, it must not be operated until repaired by the authorised service provider. Risk of electric shock!
- Plug the product into a grounded socket protected by a fuse that corresponds to the value on its nameplate. Have a qualified electrician ground the product. Our company cannot be held responsible for damages resulting from the failure to use the product with a grounded socket pursuant to local regulations.
- Unplug the product when not in use.
- Never wash the product by spreading or pouring water onto it! Risk of electric shock!
- Never touch the plug with wet hands!
- Never unplug the product by pulling the cable. Always pull the plug by holding the socket.

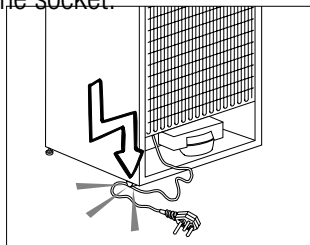

- Do not plug the refrigerator if the wall socket is loose.
- Never connect your refrigerator to energy saving devices. Such systems are harmful to your product.
- Unplug the product during installation, care, cleaning and The manufacturer cannot be held responsible for damages caused by procedures performed by unauthorised persons.

## Instructions for safety and environment

- Do not eat cone ice cream or ice cubes immediately after you take them out of the freezer compartment! This may cause frostbite in your mouth!
- Do not touch frozen food with wet hands! They may stick to your hand!
- Do not put bottled or canned liquid beverages in the freezer compartment. They may burst!
- Never use steam or steam cleaners to clean or defrost the refrigerator. Steam gets into contact with the live parts in your refrigerator, causing short circuit or electric shock!
- Do not use mechanical devices or other means to accelerate the defrosting process other than those recommended by the manufacturer.
- Never use the parts in your refrigerator such as the door and drawer as a means of support or step. This may cause the product to tip over or damage the parts of it.
- Do not damage the parts where the refrigerant is circulating with drilling or cutting tools. The refrigerant that might blow out when the gas channels of the evaporator, pipe extensions or surface coatings are punctured causes skin irritations and eye injuries.
- Do not cover or block the ventilation holes in your refrigerator with any object.
- Place the beverage with higher proofs tightly closed and vertically.
- Do not use gaseous sprays near the product since there is the risk of fire or explosion!
- Flammable items or products that contain flammable gases (e.g. spray) as well as explosive materials should never be kept in the appliance.
- Do not place vessels filled with liquid onto the product. Splashing water on an electrical part may cause electric shock or the risk of fire.
- Do not store items that need precise temperature adjustment (such as vaccines, heat-sensitive medication, science materials etc.) in the refrigerator.
- If you are not going to use the product for a long time, unplug it and remove the food in it.
- If there is a blue light on the refrigerator, do not look at this light with optical tools.
- Exposing the product to rain, snow, sun or wind is dangerous in terms of electrical safety.
- In products with mechanical control (thermostat), wait for 5 minutes to plug in the product again after unplugging.
- Do not overload the refrigerator. Objects in the refrigerator may fall down when the door is opened, causing injury or damage. Similar problems may arise if any object is placed onto the product.
- If the product has a door handle, do not pull the handle when re-locating the product. The handle might be loose.
- Be careful not to jam your hand or any other body part in the moving parts of the refrigerator.





## Instructions for safety and environment

- Do not put your hand or any other foreign materials into the ice machine while it is operating.

### 1.1.1 Hydrocarbon (HC) Warning

- If your product's cooling system contains R600a:

This gas is flammable. Therefore, pay attention not to damage the cooling system or the piping during use and transportation. If damaged, keep the product away from potential fire sources that may cause it to catch fire and ventilate the room where the product is placed.

	If the product is damaged and if you see gas leak, please keep away from the gas. It may cause frostbite when it gets into contact with the skin. (including R134)
	Ignore this warning if the cooling system of your product contains R134a.
	Type of gas used in the product is stated on the type plate which is on the left wall inside the refrigerator.
	<b>WARNING:</b> Never throw the product into fire for disposal.

### 1.1.2 For Products with a Water Dispenser/Ice Machine

- Pressure for cold water inlet shall be maximum 90 psi (620 kPa). If your water pressure exceeds 80 psi (550 kPa), use a pressure limiting valve in your mains system. If you

do not know how to check your water pressure, ask for the help of a professional plumber.

- If there is a risk of water impact in your installation, always use a water impact protection equipment in that installation. Please consult professional plumbers if you are not sure if there is water impact in your installation.
- Do not make installation on the hot water inlet.
- Use drinking water only.
- Take the necessary measures against the freezing risk of the hoses. The water temperature operating range must be 0.6°C (33°F) minimum and 38°C (100°F) maximum.

### **WARNING:**



Never connect the product to a cold water mains with a pressure of 550 kPa (80 psi) or above.

### 1.2. Intended Use

- This product has been designed for domestic use. It is not suitable for commercial use and it must not be used out of its intended use.
- It must be used only for storing food.
- The manufacturer will not take any responsibility for damages resulting from improper use or transport.
- Original spare parts will be available for 10 years after the purchase date of the product.

# Instructions for safety and environment

## 1.3. Children's Safety

- If there is a lock on the door of the product, the key should be kept out of the reach of children.
- Do not let children play with the product.

### **DANGER:**

Before disposing your old refrigerator or freezer:

- Children may get locked inside.
- Remove the doors.
- Leave the shelves to prevent children from getting inside the product easily.



## 1.4. Compliance with the WEEE Directive and Disposing the Waste Product:

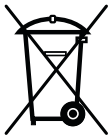

This product conforms to the EU WEE Directive (2012/19 EU). This product bears a classification symbol for waste electrical and electronic equipment (WEEE). This product has been manufactured from high quality parts and materials which can be reused and are suitable for recycling. Therefore, do not dispose the product with normal domestic waste or other waste at the end of its service life. Take it to a collection centre for recycling electrical and electronic equipment. Please consult local authorities to learn about the locations of such collection centres.

## 1.5. Compliance with the RoHS Directive:

The unit you have purchased conforms to the EU RoHS Directive (2011/65/EU). It does not contain harmful or prohibited materials specified in the Directive.

## 1.6. Packaging Information

- Packaging materials of the product have been manufactured from recyclable materials in accordance with our National Environment Regulations. Do not dispose the packaging materials with normal domestic waste or other types of waste. Take these materials to a recycling point designated by local authorities.

### **DANGER:**

#### **Risk of Fire or Explosion:**

- This product uses flammable refrigerant.
- Do not use mechanical devices to defrost the refrigerator.
- Do not use chemicals for cleaning.
- Do not pierce the refrigerant pipe.
- If the refrigerant pipe is pierced, it must be repaired only by licensed service personnel.
- Please consult the repair/user manual before cleaning the product. All safety instructions must be followed.
- Dispose the product according to federal or local regulations.



## 2 Your appliance

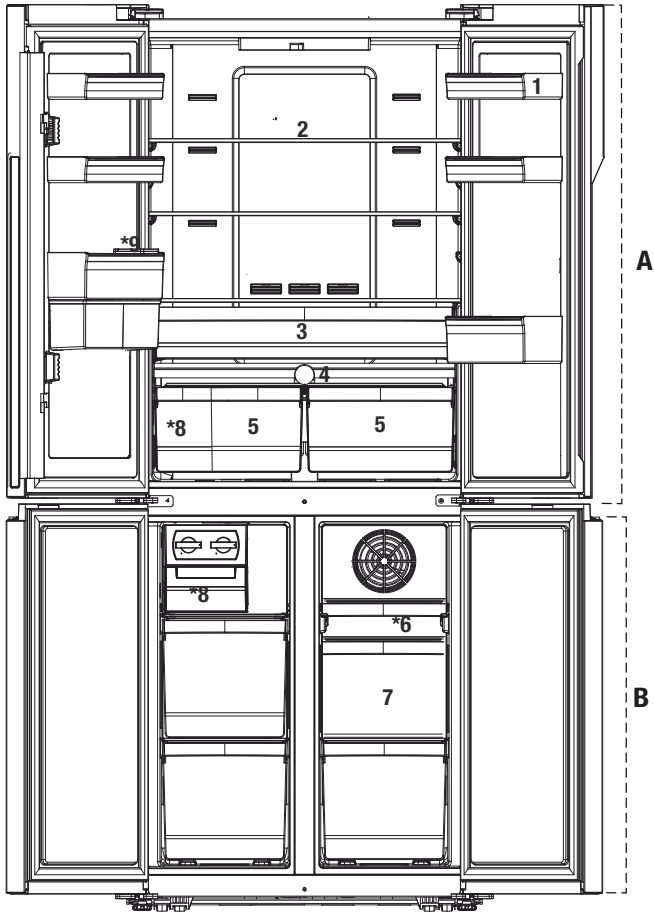

**A-** Cooler compartment

**B-** Freezer compartment

**1-** Door shelves of fridge compartment

**2-** Fridge compartment glass shelf

**3-** Chiller compartment

**4-** Everfresh

**5-** Crisper

**6-** \*Freezer compartment movable drawer

**7-** Freezer compartment drawers

**8-** \*Auto Icematic

**9-** \*Water reservoir



### It may not apply to all models.



Figures in this user manual are given as an example and may not match the product exactly. If the relevant parts are not available in the product you purchased, the figure applies to other models.



In order to prepare the product for use, refer the information in the user manual and ensure that electrical installation and water installation are appropriate. If not, call a qualified electrician and technician to have any necessary arrangements carried out.

	<b>WARNING:</b> Manufacturer shall not be held liable for damages that may arise from procedures carried out by unauthorized persons.
	<b>WARNING:</b> Product must not be plugged in during installation. Otherwise, there is the risk of death or serious injury!
	<b>WARNING:</b> : If the door clearance of the room where the product shall be placed is so tight to prevent passing of the product, contact the authorized service.

- Place the product on a level floor surface to prevent jolts.
- If you will use the product within a cabinet/furniture, leave a clearance of minimum 2 cm between the side walls and the cabinet/furniture.
- Install the product at least 30 cm away from heat sources such as hobs, heater cores and stoves and at least 5 cm away from electrical ovens.
- Product must not be subjected to direct sun light and kept in humid places.
- Appropriate air ventilation must be provided around your product in order to achieve an efficient operation. If the product is to be placed in a recess in the wall, pay attention to leave at least 5 cm distance with the ceiling and the side walls. **For versions which do not have plastic wedges, make sure that a clearance of 5 cm is left from the rear wall.**
- In environments where the room temperature drops below 10 °C, the refrigerator continues to operate to preserve the food in the freezer. However, the fresh food in the fridge compartment may freeze due to the cold environment.

### 3.1. Installing the plastic wedges

Plastic wedges supplied with the product are used to create the distance for the air circulation between the product and the rear wall.

1. To install the wedges, remove the screws on the product and use the screws supplied together with the wedges.

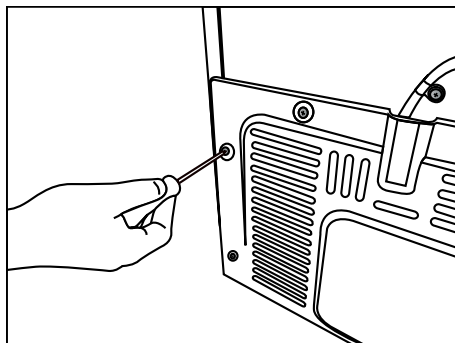

2. Insert the 2 plastic wedges onto the rear ventilation cover as illustrated in the figure.

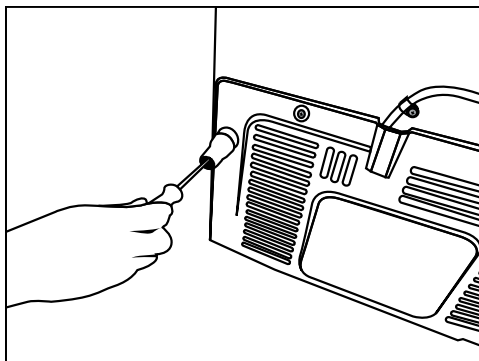

## Installation

### 3.2. Adjusting the feet

If the product stands unbalanced after installation, adjust the feet on the front by rotating them to the right or left.

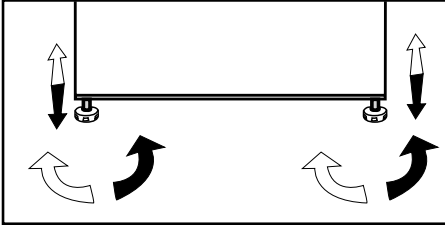

### 3.3. Electrical connection



**WARNING:** Do not make connections via extension cables or multi-plugs.



**WARNING:** Damaged power cable must be replaced by the Authorized Service Agent.



If two coolers are to be installed side by side, there should be at least 4 cm distance between them.

- Our company shall not be liable for any damages that will arise when the product is used without grounding and electrical connection in accordance with the national regulations.
- Power cable plug must be within easy reach after installation.
- Do not use extension cords or cordless multiple outlets between your product and the wall outlet.



Warning for hot surfaces!

The side walls of your product are equipped with coolant pipes to improve the cooling system. The high temperature fluid may flow through these surfaces and may heat the surfaces on the side walls. This is normal and does not require service maintenance. Be careful when touching these areas.

### 4.1. Things to be done for energy saving



Connecting the product to electric energy saving systems is risky as it may cause damage on the product.

- (h) for a freestanding appliance; 'this refrigerating appliance is not intended to be used as a built-in appliance' ;
- Do not leave the doors of your refrigerator open for a long time.
- Do not put hot food or drinks in your refrigerator.
- Do not overload the refrigerator, cooling capacity will fall when the air circulation inside is hindered.
- To be able to store the maximum amount of food in the freezer compartment of your refrigerator, remove the icebox and the ice container and place them on top of the glass shelf. The power consumption stated for your refrigerator was determined after removing the icebox, ice container, and upper and middle drawers to allow maximum loading. Using the lower drawer while loading is highly recommended.
- Depending on the features of your product, thawing frozen food in fridge compartment will both provide energy saving and preserve the food quality.
- Airflow should not be blocked by placing foods in front of the freezer compartment fan. Foods should be loaded by leaving minimum 5 cm space in front of the protective fan grid.
- The temperature sensor in the freezer compartment must be prevented from directly contacting food packages. If they get in contact, the power consumption of the product may increase.

- Since hot and humid air will not directly penetrate into your product when the doors are not opened, your product will optimize itself in conditions sufficient to protect your food. Functions and components such as compressor, fan, heater, defrost, lighting, display and so on will operate according to the needs to consume minimum energy under these circumstances.



Inside of your product must be cleaned.



If two coolers are to be installed side by side, there should be at least 4 cm distance between them.

### 4.2. Initial use

Before starting to use your refrigerator, ensure that all preparations are made in accordance with the instructions in sections "Instructions for safety and environment" and "Installation".

Run the product without putting any food for 6 hours and do not open its door unless certainly required.



You will hear a noise when the compressor starts up. The liquids and gases sealed within the refrigeration system may also give rise to noise, even if the compressor is not running and this is normal.



It is normal that the front edges of the refrigerator are hot. These areas are designed to be warm to avoid condensation.

### 5.1. Indicator panel

Indicator panels may vary according to the product model.

Audio – visual functions on the indicator panel helps you in using your product.

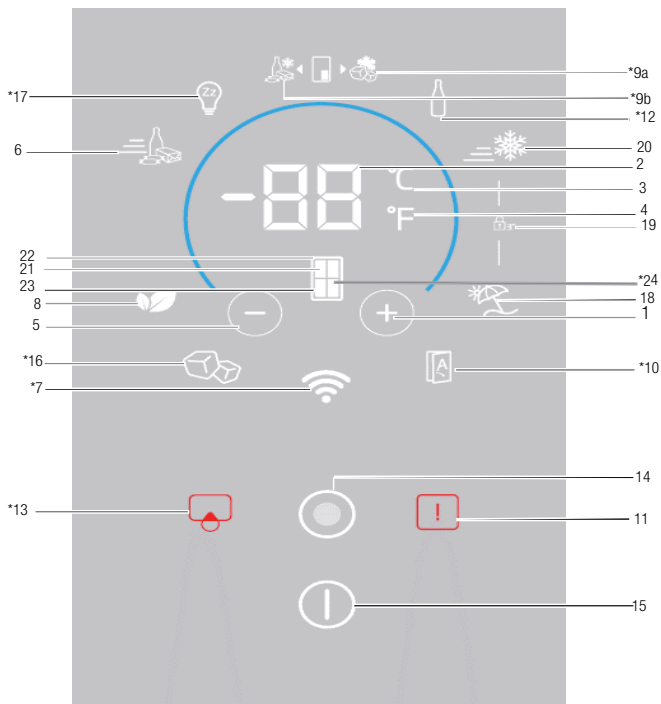

- |   |  |
|---|--|
| 1. Temperature Setting/Temperature Increase               | 13. *Filter Replacement Warning/Button     |
| 2. Temperature Setting-Slider/Temperature value indicator | 14. Menu Button                            |
| 3. Temperature Unit Selection (°C) Celsius indicator      | 15. Product On/Off indicator/button        |
| 4. Temperature Unit Selection (°F) Fahrenheit indicator   | 16. *Icematic indicator/button             |
| 5. Temperature Setting/Temperature Decrease               | 17. *Sabbath Mode                          |
| 6. Quick Cooling function indicator/button                | 18. Vacation Mode indicator/button         |
| 7. * Wireless   | 19. Key Lock indicator                     |
| 8. Economy Mode indicator/button                          | 20. Quick Freeze function indicator/button |
| 9. *Joker Freezer indicator/button                        | 21. Cabinet Selection                      |
| 10. *Auto Door  | 22. Fridge compartment indicator           |
| 11. High Temperature Warning/Failure                      | 23. Freezer compartment indicator          |
| 12. *Bottle Cooler  | 24. *Joker compartment indicator           |

**It may not apply to all models.**



\*Optional: Figures in this user manual are given as an example and may not match the product exactly. If the relevant parts are not available in the product you purchased, the figure applies to other models. NOTE \*Joker means a compartment that can be either Freezer or Fridge but is not all models.

## Operating the product

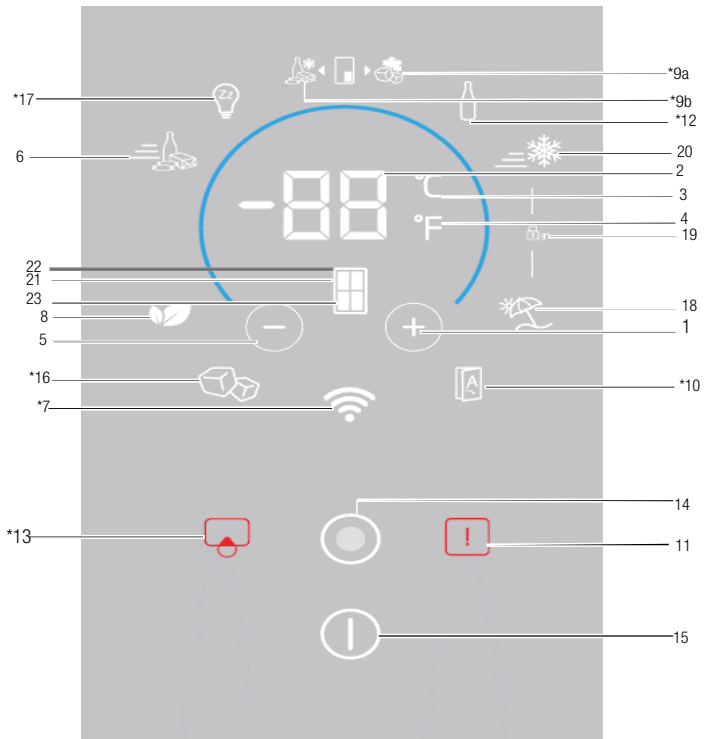

- |   |  |
|---|--|
| 1. Temperature Setting/Temperature Increase               | 13. *Filter Replacement Warning/Button     |
| 2. Temperature Setting-Slider/Temperature value indicator | 14. Menu Button                            |
| 3. Temperature Unit Selection (°C) Celsius indicator      | 15. Product On/Off indicator/button        |
| 4. Temperature Unit Selection (°F) Fahrenheit indicator   | 16. *Icematic indicator/button             |
| 5. Temperature Setting/Temperature Decrease               | 17. *Sabbath Mode                          |
| 6. Quick Cooling function indicator/button                | 18. Vacation Mode indicator/button         |
| 7. * Wireless   | 19. Key Lock indicator                     |
| 8. Economy Mode indicator/button                          | 20. Quick Freeze function indicator/button |
| 9. *Joker Freezer indicator/button                        | 21. Cabinet Selection                      |
| 10. *Auto Door  | 22. Fridge compartment indicator           |
| 11. High Temperature Warning/Failure                      | 23. Freezer compartment indicator          |
| 12. *Bottle Cooler  |  |

**It may not apply to all models.**



**\*Optional:** Figures in this user manual are given as an example and may not match the product exactly. If the relevant parts are not available in the product you purchased, the figure applies to other models.

## Operating the product

### 1. Temperature Setting/Temperature Increase

It increases the temperature of the selected compartment when pressed.

### 2. Temperature Setting-Slider/Temperature value indicator

It shows the temperature value of the selected compartment. Moreover, you can slide your finger top-down or down-top to increase or decrease the temperature value.

### 3. Temperature Unit Selection (°C)

#### Celsius indicator

When this button is pressed, the temperature value will be activated as Celsius.

It is the Celsius indicator. When Celsius indication has been activated, temperature set values will be shown in Celsius and the relevant icon will turn on completely;

the Fahrenheit icon will turn on by 50%.

### 4. Temperature Unit Selection (°F)

#### Fahrenheit indicator

When this button is pressed, the temperature value will be activated as Fahrenheit.

It is the Fahrenheit indicator. When Fahrenheit indication has been activated, temperature set values will be shown in Fahrenheit and the relevant icon will turn on completely;

the Celsius icon will turn on by 50%.

### 5. Temperature Setting/Temperature Decrease

It decreases the temperature of the selected compartment when pressed.

### 6. Quick cooling function indicator

When the Quick Cooling function has been activated, the indicator will turn on completely. When the function has been cancelled, the product will return to its usual settings and the indicator will turn on by 50%.

### Quick cooling function button

It is used to activate or deactivate the quick cooling function.



Use quick cooling function when you want to quickly cool the food placed in the fridge compartment. If you want to cool large amounts of fresh food, activate this function before putting the food into the product.



If you do not cancel it, quick cooling will cancel itself automatically after 8 hours at the most or when the fridge compartment reaches to the required temperature.



If you press the quick cooling button repeatedly with short intervals, the electronic circuit protection will be activated and the compressor will not start up immediately.



This function is not recalled when power restores after a power failure.

## 7. Wireless

When this button is pressed, the product will be introduced to the home network for the first time. Once the function has been activated, the indicator will turn on by 100%; and if the function has been cancelled, it will turn on by 50%.

## 8. Economy Mode indicator/button

Press this button to activate/deactivate the economy mode.

Once the economy mode has been activated, the indicator will turn on by 100%. While the function is active, the freezer will start to work on economy mode after at least 6 hours. Once the function has been cancelled, the indicator will turn on by 50%.

### 9a. \*Joker Freezer indicator/button

Once the button has been pressed, the joker compartment will function as a freezer and the indicator will turn on by 100%. The joker fridge indicator will turn on by 50%.

### 9b. \*Joker fridge indicator/button

Once the button has been pressed, the joker compartment will function as a fridge and the indicator will turn on by 100%. The joker freezer indicator will turn on by 50%.

## 10.\* Auto Door

Press this button to activate/deactivate the auto door mode. Once the function has been activated, the indicator will turn on by 100%. Once the function has been cancelled, the indicator will turn on by 50%.

## Operating the product

While the function is active, touch the relevant section on the door handle to open the door automatically.

### 11. High Temperature Warning/Failure

This indicator illuminates during power failure, high temperature failures and error warnings. During long-term power failures, the highest temperature value that the freezer compartment reaches will blink on the digital display. After checking the food located in the freezer compartment, press the high temperature warning button to clear the warning.

### 12. \*Bottle Cooler

Press this button to activate/deactivate the bottle cooler mode.

Once the function has been cancelled, the indicator will turn on by 100%. If the function is cancelled, the indicator will turn on by 50%.

### 13. \*Filter Replacement Warning/Button

This icon turns on when the filter needs to be reset.

Once this button is pressed, the filter will be reset and the reset icon will go off.

### 14. Menu Button

Use this button to switch the display to sleep mode or cancel the sleep mode. If you do not press any button or open the door for 30 seconds, it will automatically switch to sleep mode.

### 15. Product On/Off indicator/button

To turn on/off the product, press and hold the On/Off button for 3 seconds.

After the product has been turned off, only the on/off indicator will turn on by 100%; all the other indicators will go off. To turn on the product, press and hold the same button for 3 seconds. The refrigerator will become active and the on/off indicator will turn on by 50%.

### 16. \*Icematic indicator/button

Press this button to activate/deactivate the icematic. If the indicator is on by 100%, this means that the icematic is working. If the indicator is on by 50%, this means that the icematic is off.



Water flow from water tank will stop when this function is not selected. However, ice made previously can be taken from the icematic.

### 17. \*Sabbath Mode

Press this button to activate/deactivate the Sabbath mode. Once the function has been activated, the indicator will turn on by 100%. Once the function has been cancelled, the indicator will turn on by 50%.

### 18. Vacation Mode indicator/button

Press this button to activate the vacation button; the vacation mode indicator will turn on by 100%. When the vacation function is active, "--" will be displayed on the Temperature Value display and no active cooling will be performed in the fridge compartment. It is not suitable to keep the food in the fridge compartment when this function is activated. Other compartments will continue to be cooled according to their set temperatures.

To cancel this function, press the **Vacation function** button again. Once the function has been cancelled, the indicator will turn on by 50%.

### 19. Key Lock indicator

Press **quick cooling** and **vacation** buttons simultaneously for 3 seconds. While pressing the button, a countdown will start on the temperature value display. Once the key lock has been activated, the key lock indicator will turn on by 100% and the key lock mode will become activated. Buttons will not function if the Key lock mode is active. Press **quick cooling** and **vacation** buttons again simultaneously for 3 seconds. While pressing the button, a countdown will start on the temperature value display. Once the key lock has been cancelled, the key lock indicator will turn on by 50% and the key lock mode will be deactivated.

Activate this function if you want to prevent changing of the temperature setting of the refrigerator.

### 20.Quick freeze function indicator

When the Quick Freeze function has been activated, the indicator will turn on by 100%. When the function has been cancelled, the product will return to its usual settings and the indicator will turn on by 50%.

### Quick freeze function button

It is used to activate or deactivate the quick freeze function.

## Operating the product

Press this button to activate or deactivate the quick freeze function. When you activate the function, the freezer compartment will be cooled to a temperature lower than the set value.



Use the quick freeze function when you want to quickly freeze the food placed in freezer compartment. If you want to freeze large amounts of fresh food, activate this function before putting the food into the product.



If you do not cancel it, Quick Freeze will cancel itself automatically after 4 hours at the most or when the fridge compartment reaches to the required temperature.



This function is not recalled when power restores after a power failure.

### 21. Cabinet Selection

Press the cabinet selection button to see and change the temperature value of the fridge or freezer on the Temperature value indicator.

### 22. Fridge compartment indicator

When this indicator is active, temperature of the fridge compartment will be displayed on the temperature value indicator.

### 23. Freezer compartment indicator

When this indicator is active, temperature of the freezer compartment will be displayed on the temperature value indicator.

### 24.\*Joker compartment indicator

When this indicator is active, temperature of joker freezer compartment will be displayed on the temperature value indicator.



## Operating the product

### 5.2. Indicator panel

Indicator panels may vary according to the product model.

Audio – visual functions on the indicator panel helps you in using your product.

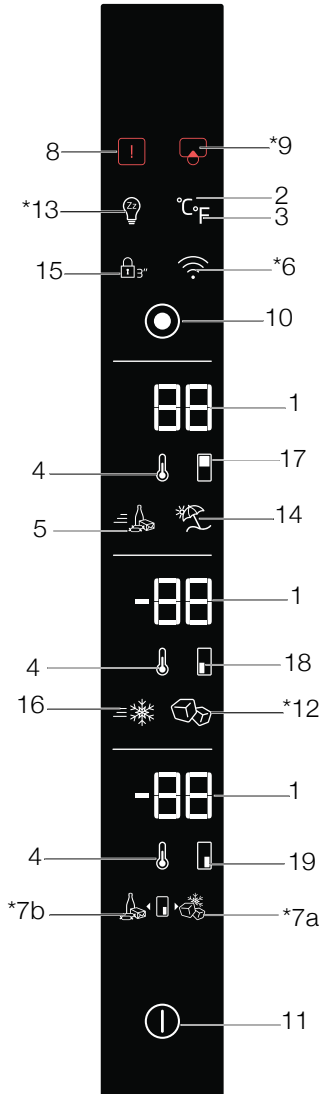

**It may not apply to all models.**



**\*Optional:** Figures in this user manual are given as an example and may not match the product exactly. If the relevant parts are not available in the product you purchased, the figure applies to other models.

## Operating the product

1. Temperature Setting-Slider/Temperature value indicator
2. Temperature Unit Selection (°C) Celsius indicator
3. Temperature Unit Selection (°F) Fahrenheit indicator
4. Temperature Setting/Temperature Decrease
5. Quick Cooling function indicator/button
6. \* Wireless
7. \*Joker Freezer indicator/button
8. High Temperature Warning/Failure
9. \*Filter Replacement Warning/Button
10. Menu Button
11. Product On/Off indicator/button
12. \*Icematic indicator/button
13. \*Sabbath Mode
14. Vacation Mode indicator/button
15. Key Lock indicator
16. Quick Freeze function indicator/button
17. Fridge compartment indicator
18. Freezer compartment indicator
19. \*Joker compartment indicator

### 1. Temperature Setting-Slider/Temperature value indicator

It shows the temperature value of the selected compartment. Moreover, you can slide your finger top-down or down-top to increase or decrease the temperature value.

### 2. Temperature Unit Selection (°C) Celsius indicator

When this button is pressed, the temperature value will be activated as Celsius.

It is the Celsius indicator. When Celsius indication has been activated, temperature set values will be shown in Celsius and the relevant icon will turn on completely;

the Fahrenheit icon will turn on by 50%.

### 3. Temperature Unit Selection (°F) Fahrenheit indicator

When this button is pressed, the temperature value will be activated as Fahrenheit.

It is the Fahrenheit indicator. When Fahrenheit indication has been activated, temperature set values will be shown in Fahrenheit and the relevant icon will turn on completely;

the Celsius icon will turn on by 50%.

### 4. Temperature Setting/Temperature Decrease

It decreases the temperature of the selected compartment when pressed.

### 5. Quick cooling function indicator

When the Quick Cooling function has been activated, the indicator will turn on completely. When the function has been cancelled, the product will return to its usual settings and the indicator will turn on by 50%.

### Quick cooling function button

It is used to activate or deactivate the quick cooling function.



Use quick cooling function when you want to quickly cool the food placed in the fridge compartment. If you want to cool large amounts of fresh food, activate this function before putting the food into the product.



If you do not cancel it, quick cooling will cancel itself automatically after 8 hours at the most or when the fridge compartment reaches to the required temperature.



If you press the quick cooling button repeatedly with short intervals, the electronic circuit protection will be activated and the compressor will not start up immediately.



This function is not recalled when power restores after a power failure.

### 6. Wireless

When this button is pressed, the product will be introduced to the home network for the first time. Once the function has been activated, the indicator will turn on by 100%; and if the function has been cancelled, it will turn on by 50%.

## Operating the product

### 7a. \*Joker Freezer indicator/button

Once the button has been pressed, the joker compartment will function as a freezer and the indicator will turn on by 100%. The joker fridge indicator will turn on by 50%.

### 7b. \*Joker fridge indicator/button

Once the button has been pressed, the joker compartment will function as a fridge and the indicator will turn on by 100%. The joker freezer indicator will turn on by 50%.

### 8. High Temperature Warning/Failure

This indicator illuminates during power failure, high temperature failures and error warnings. During long-term power failures, the highest temperature value that the freezer compartment reaches will blink on the digital display. After checking the food located in the freezer compartment, press the high temperature warning button to clear the warning.

### 9. \*Filter Replacement Warning/Button

This icon turns on when the filter needs to be reset. Once this button is pressed, the filter will be reset and the reset icon will go off.

### 10. Menu Button

Use this button to switch the display to sleep mode or cancel the sleep mode. If you do not press any button or open the door for 30 seconds, it will automatically switch to sleep mode.

### 11. Product On/Off indicator/button

To turn on/off the product, press and hold the On/Off button for 3 seconds.

After the product has been turned off, only the on/off indicator will turn on by 100%; all the other indicators will go off. To turn on the product, press and hold the same button for 3 seconds. The refrigerator will become active and the on/off indicator will turn on by 50%.

### 12. \*Icematic indicator/button

Press this button to activate/deactivate the icematic. If the indicator is on by 100%, this means that the icematic is working. If the indicator is on by 50%, this means that the icematic is off.



Water flow from water tank will stop when this function is not selected. However, ice made previously can be taken from the icematic.

### 13. \*Sabbath Mode

Press this button to activate/deactivate the Sabbath mode. Once the function has been activated, the indicator will turn on by 100%. Once the function has been cancelled, the indicator will turn on by 50%.

### 14. Vacation Mode indicator/button

Press this button to activate the vacation button; the vacation mode indicator will turn on by 100%. When the vacation function is active, “- -” will be displayed on the Temperature Value display and no active cooling will be performed in the fridge compartment. It is not suitable to keep the food in the fridge compartment when this function is activated. Other compartments will continue to be cooled according to their set temperatures.

To cancel this function, press the **Vacation function** button again. Once the function has been cancelled, the indicator will turn on by 50%.

### 15. Key Lock indicator

Press **quick cooling and vacation** buttons simultaneously for 3 seconds. While pressing the button, a countdown will start on the temperature value display. Once the key lock has been activated, the key lock indicator will turn on by 100% and the key lock mode will become activated. Buttons will not function if the Key lock mode is active. Press quick cooling and vacation buttons again simultaneously for 3 seconds. While pressing the button, a countdown will start on the temperature value display. Once the key lock has been cancelled, the key lock indicator will turn on by 50% and the key lock mode will be deactivated.

Activate this function if you want to prevent changing of the temperature setting of the refrigerator.

### 16.Quick freeze function indicator

When the Quick Freeze function has been activated, the indicator will turn on by 100%. When the function has been cancelled, the product will return to its usual settings and the indicator will turn on by 50%.

## Operating the product

### Quick freeze function button

It is used to activate or deactivate the quick freeze function.

Press this button to activate or deactivate the quick freeze function. When you activate the function, the freezer compartment will be cooled to a temperature lower than the set value.



Use the quick freeze function when you want to quickly freeze the food placed in freezer compartment. If you want to freeze large amounts of fresh food, activate this function before putting the food into the product.



If you do not cancel it, Quick Freeze will cancel itself automatically after 4 hours at the most or when the fridge compartment reaches to the required temperature.



This function is not recalled when power restores after a power failure.

### 17. Fridge compartment indicator

When this indicator is active, temperature of the fridge compartment will be displayed on the temperature value indicator.

### 18. Freezer compartment indicator

When this indicator is active, temperature of the freezer compartment will be displayed on the temperature value indicator.

### 19.\*Joker compartment indicator

When this indicator is active, temperature of joker freezer compartment will be displayed on the temperature value indicator.

# Operating the product

## 5.3. Indicator panel

Indicator panels may vary according to the product model.

Audio – visual functions on the indicator panel helps you in using your product.

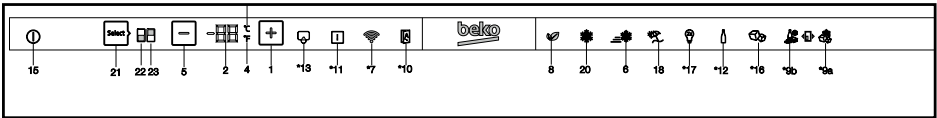

### 1. Temperature Adjustment / Temperature Increase

When pressed, increases the temperature of the selected compartment.

### 2. Temperature Adjustment- Slider/ Temperature value indicator

Shows the temperature value of the selected compartment. Plus, you can slide your finger up or down to increase or decrease the temperature.

### 3. Temperature Unit Selection (°C) Celsius indicator

When the button is pressed, the temperature unit is selected as Celsius.

It is the Celsius indicator. When the Celsius indication is activated, temperature set values are shown in Celsius and the relevant icon turns on by 100%.

Fahrenheit icon turns on by 50%.

### 4. Temperature Unit Selection (°F) Fahrenheit indicator

When the button is pressed, the temperature unit is selected as Celsius.

It is the Fahrenheit indicator. When the Fahrenheit indication is activated, temperature set values are shown in Fahrenheit and the relevant icon turns on completely.

Celsius icon turns on by 50%.

### 5. Temperature Adjustment / Temperature Decrease

When pressed, decreases the temperature of the selected compartment.

### 6. Quick fridge function indicator

When the quick fridge function is activated, the indicator turns on by 100%. When the function is cancelled, the product returns to its normal settings and the indicator turns on by 50%.

### Quick fridge function button

It is used to activate or deactivate the quick fridge function.



Use quick fridge function when you want to quickly cool the food placed in the fridge compartment. If you want to cool large amounts of fresh food, activate this function before putting the food into the product.



If you do not cancel it, quick fridge will cancel itself automatically after 8 hours at the most or when the fridge compartment reaches to the required temperature.



If you press the quick fridge button repeatedly with short intervals, the electronic circuit protection will be activated and the compressor will not start up immediately.



This function is not recalled when power restores after a power failure.

### 7. \*Wireless

When the button is pressed, the product is introduced to the home network. When the function is activated, the indicator turns on by 100%, when it is cancelled, the indicator turns on by 50%.

### 8. Eco mode indicator/button

Press this button to activate and deactivate the Eco mode.

When the Eco mode is activated, the indicator turns on by 100%. When the function is active, the freezer will start to run in the eco mode at least 6 hours later. When the function is cancelled, the indicator will turn on by 50%.

## Operating the product

### 9a. \*Joker freezer indicator/button

When the button is pressed, the joker compartment runs as a freezer and the indicator turns on by 100%. Joker fridge compartment turns on by 50%.

### 9b. \*Joker fridge indicator/button

When the button is pressed, the joker compartment runs as a fridge and the indicator turns on by 100%. Joker freezer compartment turns on by 50%.

### 10.\* Auto Door

Press this button to activate or deactivate the Auto Door mode. When the function is activated, the indicator turns on by 100%. When the function is cancelled, the indicator will turn on by 50%.

When the function is active, touch the relevant section on the door handle to make the door open automatically.

### 11. High Temperature Warning/Error

This indicator illuminates during power failure, high temperature failures and error warnings. During long-term power failures, the highest temperature value that the freezer compartment reaches will blink on the digital display. After checking the food located in the freezer compartment, press the high temperature button to clear the warning.

### 12. \*Bottle Cooler

Press this button to activate or deactivate the bottle cooler mode.

When the function is activated, the indicator turns on by 100%. When the function is cancelled, the indicator turns on by 50%.

### 13. \*Filter Replacement Warning/Button

This icon turns on when the filter needs to be reset. When the button is pressed, the filter will be reset and the reset icon will go off.

### 14. Menu Button

It is used to activate or deactivate the sleep mode for the display. If you do not press any button or open the door in 30 seconds, it switches to sleep mode automatically.

### 15. Product On/Off indicator/button

Press and hold the On/Off button for 3 seconds to switch on or off the product.

When the product is turned off, the product on/off indicator turns on by 100%, and all the other indicators go off. To turn on the product, press and hold the button for 3 seconds again. The refrigerator will turn on and the on/off indicator will turn on by 50%.

### 16. \*Icematic indicator/button

Press this button to activate or deactivate the Icematic. If the indicator is on by 100%, this means that the icematic is running. If the indicator is on by 50%, this means that the icematic is off.



Water flow from water tank will stop when this function is not selected. However, ice made previously can be taken from the icematic.

### 17. \*Sabbath Mode

Press this button to activate or deactivate the Sabbath mode. When the function is activated, the indicator turns on by 100%. When the function is cancelled, the indicator will turn on by 50%.

### 18. Vacation Mode indicator/button

Press this button to activate the vacation mode. The vacation mode indicator will turn on by 100%. When the vacation mode is active, “- -” will be shown on the Temperature Value Indicator and no active cooling is performed in the fridge compartment. It is not suitable to keep the food in the fridge compartment when this function is activated. Other compartments will continue to be cooled according to their set temperatures.

To cancel this function press **Vacation function** button again. When the function is cancelled, the indicator will turn on by 50%.

### 19. Key Lock indicator

Press and hold the **quick fridge and vacation** buttons simultaneously for 3 seconds. When pressing the button, a countdown will start in the temperature value indicator. When the key lock is activated, the key lock indicator will turn on by 100% and the key lock mode will be enabled. Buttons will not function when the key lock mode is active. Press and hold the quick fridge and vacation buttons again simultaneously for 3 seconds. When pressing the button, a countdown will start in the temperature value indicator. When the key lock is cancelled, the key lock indicator will turn on by 50% and the key lock mode will be disabled.

## Operating the product

Activate this function if you want to prevent changing of the temperature setting of the refrigerator.

### 20. Quick freeze function indicator

When the quick freeze function is activated, the indicator will turn on by 100%. When the function is cancelled, the product will return to its normal settings and the indicator will turn on by 50%.

### Quick freeze function button

It is used to activate or deactivate the quick freeze function.

Press this button to activate or deactivate the quick freeze function. When you activate the function, the freezer compartment will be cooled to a temperature lower than the set value.



Use the quick freeze function when you want to quickly freeze the food placed in freezer compartment. If you want to freeze large amounts of fresh food, activate this function before putting the food into the product.



If you do not cancel it, Quick Freeze will cancel itself automatically after 4 hours at the most or when the fridge compartment reaches to the required temperature.



This function is not recalled when power restores after a power failure.

### 21. Cabin Selection

Press the cabin selection button to see and change the temperature value of the fridge or freezer on the Temperature Value indicator.

### 22. Fridge compartment indicator

When this indicator is active, the temperate of the fridge compartment is displayed on the temperature value indicator.

### 23 Freezer compartment indicator

When this indicator is active, the temperate of the freeze compartment is displayed on the temperature value indicator.

## Operating the product

### 5.4. Ice machine

#### (This feature is optional)

Ice machine allows you to obtain ice from the product easily.

Using the ice machine

1. Remove the water tank from the fridge compartment.
2. Fill the water tank with water.
3. Replace the water tank. First ice cubes will be ready in approximately four hours in the ice machine drawer located in the freezer compartment.



While the water tank is completely filled, you will be able to obtain approximately 60-70 ice cubes.



The water within the tank should be renewed in every 2-3 weeks.

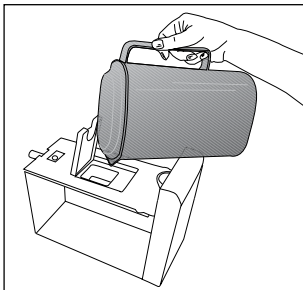
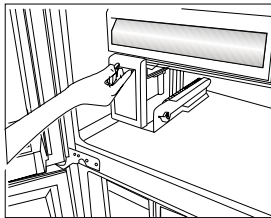
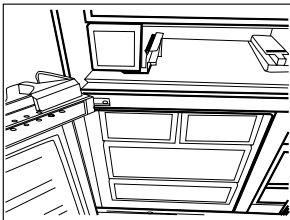

### 5.5. Icematic

#### (This feature is optional)

Icematic allows you to obtain ice from the product easily.

#### Using the icematic

1. Take out the icematic pulling it out carefully.
2. Fill the icematic with water.
3. Place the icematic in place. About two hours later, the ice is ready.
4. To obtain ice, turn the knobs on the ice reservoirs clockwise by 90° degrees. Ice cubes in the reservoirs will fall down into the ice storage container below.
5. You may take out the ice storage container and serve the ice cubes.



Do not remove the Icematic from its seating to obtain ice.



If you wish, you may keep the ice cubes in the ice storage container. The ice storage container is just for accumulating ice cubes. Do not put water in it. Otherwise, it will break.

### 5.6. Ice container

#### (This feature is optional)

Icematic allows you to obtain ice from the product easily.

#### Using the ice container

1. Remove the ice container from the freezer compartment.
2. Fill the ice container with water.
3. Place the ice container in the freezer compartment. About two hours later, the ice is ready.
4. Remove the ice container from the freezer compartment and bend it over the service plate. Ice cubes will easily fall down to the service plate.



## Operating the product

### 5.7. Deodorising Module

#### (FreshGuard)

##### (This feature is optional)

The deodorising module eliminates the bad odours in your refrigerator in a short while before they pervade the surfaces. Thanks to this module located in the ceiling of the fresh food compartment, the air actively passes over the odour filter, meanwhile bad odour molecules decompose, and the air that has come out after being cleaned is given back into the fresh food compartment. This way, the unwanted odours that may form while foods are being stored in the refrigerator can be eliminated before they pervade the surfaces.

This is achieved via the fan, LED and the odour filter in the module. The deodorising module will get automatically activated periodically. The noise that will be heard due to the fan during the periodical operation is normal. If the door of the fresh food compartment is opened while the module is active, the fan will stop temporarily and it will continue to operate once the door has been closed. In case of power failure, the deodorising module will start to operate once the power is back.

**Info:** To prevent bad odours that may emerge from the mixing of smells of different foods, we recommend you to store aromatic foods such as cheese, olives and delicatessen products in their sealed packages. For the safety of other foods stored and to prevent odours, we recommend you to remove the foods you have realised are spoiled from the refrigerator as soon as possible.



### 5.8. Ionizer

#### (This feature is optional)

The ionizer system in the cooler compartment's air duct serves to ionize the air. The negative ion emissions will eliminate bacteria and other molecules causing odour in the air.

## Operating the product

### 5.9. Chiller compartment

#### (This feature is optional)

Use this compartment to store delicatessen that shall be stored in a lower temperature or meat products that you will consume in a short time. Do not store your fruits or vegetables in this compartment.

You can increase the inner volume of your product by removing any of the chiller compartments.

To remove, just pull the compartment until it stops, and then lift it and pull towards yourself.

### 5.10. Crisper

Crisper of the refrigerator is designed specially to keep the vegetables fresh without losing their humidity. For this purpose, cool air circulation is intensified around the crisper in general. Store your fruits and vegetables in this compartment. To preserve green leafy vegetables for a longer time, do not store them near fruits.

### 5.11. Movable Middle Section

Movable middle section is intended to prevent the cold air inside your refrigerator from escaping outside.

1- Sealing is provided when the gaskets on the door presses on the surface of the movable middle section while the fridge compartment doors are closed.

2- Another reason that your refrigerator is equipped with a movable middle section is that it increases the net volume of the fridge compartment. Standard middle sections occupy some non-usable volume in the refrigerator.

3-Movable middle section is closed when the left door of the fridge compartment is opened.

4-It must not be opened manually. It moves under the guidance of the plastic part on the body while the door is closed.

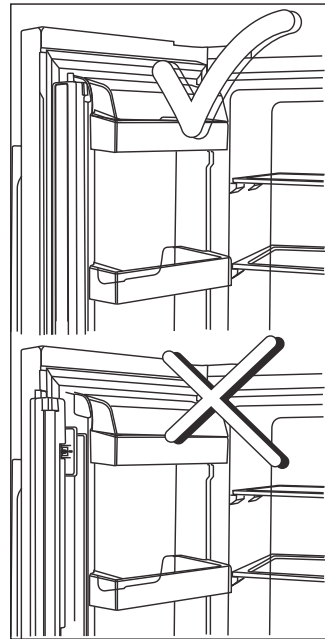

### 5.12. Using the water dispenser

#### (This feature is optional)



It is normal for the first few glasses of water taken from the dispenser to be warm.



If the water dispenser is not used for a long period of time, dispose of first few glasses of water to obtain fresh water.

1. Push in the lever of the water dispenser with your glass. If you are using a soft plastic cup, pushing the lever with your hand will be easier.

## Operating the product

2. After filling the cup up to the level you want, release the lever.

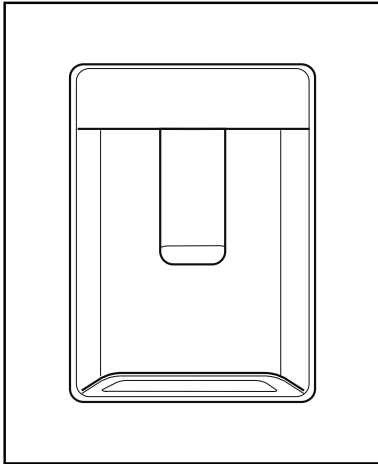

Please note, how much water flows from the dispenser depends on how far you depress the lever. As the level of water in your cup / glass rises, gently reduce the amount of pressure on the lever to avoid overflow. If you slightly press the arm, the water will drip; this is quite normal and not a failure.



Use clean drinking water only.



Capacity of the water tank is 3 liters; do not overfill.

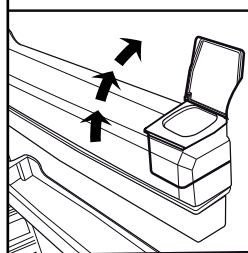
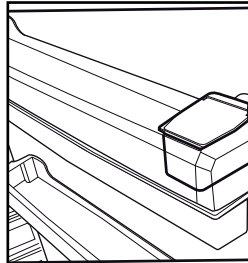

### 5.13. Filling the water dispenser's tank

Water tank filling reservoir is located inside the door rack.

1. Open the cover of the tank.
2. Fill the tank with fresh drinking water.
3. Close the cover.



Do not fill the water tank with any other liquid except for water such as fruit juices, carbonated beverages or alcoholic drinks which are not suitable to use in the water dispenser. Water dispenser will be irreparably damaged if these kinds of liquids are used. Warranty does not cover such usages. Some chemical substances and additives contained in these kinds of drinks/liquids may damage the water tank.

## Operating the product

### 5.14. Cleaning the water tank

1. Remove the water filling reservoir inside the door rack.
2. Remove the door rack by holding from both sides.
3. Grab the water tank from both sides and remove it with an angle of 45°.
4. Remove the cover of the water tank and clean the tank.



Components of the water tank and water dispenser should not be washed in dishwasher.

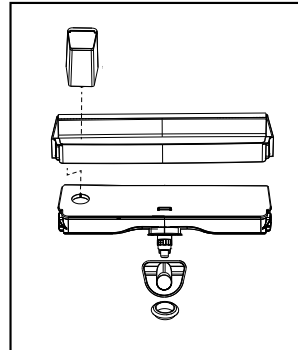
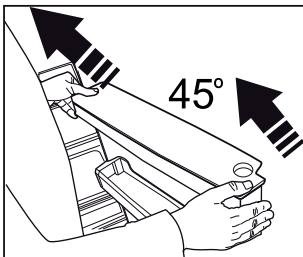
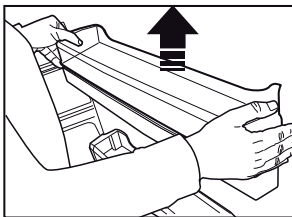
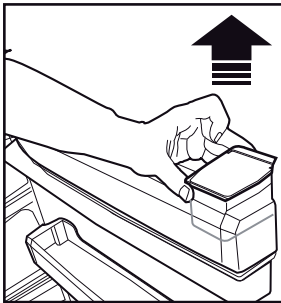
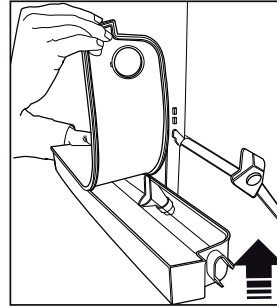

### 5.15. Drip tray

Water that dripped while using the water dispenser accumulates in the spillage tray. Remove the plastic filter as shown in the figure. With a clean and dry cloth, remove the water that has accumulated.

## Operating the product

### 5.16. Everfresh (Humidity-controlled crisper)

#### (This feature is optional)

Thanks to the humidity-controlled crisper, you can store fruits and vegetables under ideal humidity conditions for a longer time. You can control the humidity inside the refrigerator thanks to the humidity setting system with 3 options, which is located on the front side of the crisper. We recommend you to select the vegetable option when storing vegetables only, fruit option when storing fruits only, and mix option when storing fruits and vegetables at the same time.

To benefit from the humidity control system and increase the storage life of foods, we recommend you not to store your fruits and vegetables in plastic bags. If the vegetables are left inside their bags, this will cause them to decompose in a short period of time. It is especially recommended not to store cucumber and broccoli in plastic bags. In case contacting with other vegetables is not preferred for hygiene concerns, use a perforated brown bag and other similar packaging materials instead of a bag.

While the vegetables are being placed, specific gravity of the vegetables should be taken into consideration. Heavy and hard vegetables should be put at the bottom of the crisper and the lightweight and soft vegetables should be placed over.

Do not place together the pear, apricot, peach, etc. and apple in particular which have a high level of generation of ethylene gas in the same crisper with the other vegetables and fruit. The ethylene gas which is emitted by these fruit may cause the other fruit to ripen faster and decompose in a shorter time.



### 5.17. Blue light/HarvestFresh

#### (This feature is optional)

#### For the blue light,

Fruits and vegetables stored in the crispers that are illuminated with a blue light continue their photosynthesis by means of the wavelength effect of blue light and thus preserve their vitamin content.

#### For HarvestFresh,

Fruits and vegetables stored in crispers illuminated with the HarvestFresh technology preserve their vitamins for a longer time thanks to the blue, green, red lights and dark cycles, which simulate a day cycle.

If you open the door of the refrigerator during the dark period of the HarvestFresh technology, the refrigerator will automatically detect this and enable the blue-green or red light to illuminate the crisper for your convenience. After you have closed the door of the refrigerator, the dark period will continue, representing the night time in a day cycle.

## Operating the product

### 5.18. Freezing fresh food

- In order to preserve the quality of the food, it shall be frozen as quickly as possible when it is placed in the freezer compartment, use the fast freezing feature for this purpose.
- You may store the food longer in freezer compartment when you freeze them while they are fresh.
- Pack the food to be frozen and close the packing so that it would not allow entrance of air.
- Ensure that you pack your food before putting them in the freezer. Use freezer containers, foils and moisture-proof papers, plastic bags and other packing materials instead of traditional packing papers.
- Label each pack of food by adding the date before freezing. You may distinguish the freshness of each food pack in this way when you open your freezer each time. Store the food frozen before in the front side of compartment to ensure that they are used first.
- Frozen food must be used immediately after they are thawed and they should not be re-frozen.
- Do not freeze too large quantities of food at one time.

Freezer Compartment Setting	Fridge Compartment Setting	Remarks
-18°C	4°C	This is the normal recommended setting.
-20, -22 or -24°C	4°C	These settings are recommended when the ambient temperature exceeds 30°C.
Quick Freeze	4°C	Use when you wish to freeze your food in a short time. Your product will return to its previous mode when the process is over.
-18°C or colder	2°C	Use these settings if you think that your fridge compartment is not cold enough because of the hot ambient conditions or frequent opening and closing of the door.

## Operating the product

### 5.19. Recommendations for preserving the frozen food

Compartment shall be set to  $-18^{\circ}\text{C}$  at least.

1. Put packages in the freezer as quickly as possible after purchase without allowing the time to thaw.
2. Check whether the "Use By" and "Best Before" dates on the packaging are expired or not before freezing it.
3. Ensure that the package of the food is not damaged.

### 5.20. Deep-freeze information

According to IEC 62552 standards, the product shall freeze at least 4.5 kg of food at  $25^{\circ}\text{C}$  ambient temperature to  $-18^{\circ}\text{C}$  or lower within 24 hours for every 100-litres of freezer volume.

It is possible to preserve the food for a long time only at  $-18^{\circ}\text{C}$  or lower temperatures.

You can keep the freshness of food for many months (at  $-18^{\circ}\text{C}$  or lower temperatures in the deep freeze).

Foods to be frozen should not be allowed to come in contact with the previously frozen items to prevent them from getting thawed partially.

Boil the vegetables and drain their water in order to store vegetables for a longer time as frozen. After draining their water, put them in air-proof packages and place them inside the freezer. Food such as bananas, tomatoes, lettuce, celery, boiled eggs, potatoes are not suitable for freezing. When these foods are frozen, only their nutritional value and taste shall be affected negatively. They shall not be spoiled so that they would create a risk for human health.

### 5.21. Placing the food

Freezer compartment shelves	Various frozen food such as meat, fish, ice cream, vegetables and etc.
Refrigerator compartment shelves	Food in pans, covered plates and closed containers, eggs (in closed container)
Door shelves of fridge compartment	Small and packaged food or beverage
Crisper	Vegetables and fruits
Fresh zone compartment	Delicatessen (breakfast food, meat products that shall be consumed in a short time)

### 5.22. Door open warning

#### (This feature is optional)

An audio warning signal will be given when the door of your product is left open for 1 minute. This warning will be muted when the door is closed or any of the display buttons (if any) are pressed.

### 5.23. Illumination lamp

LED lamps are used as illumination lamps. Contact authorized service in case of any problem with this type of light.

The lighting lamps used in this product are not intended for house lighting and not suited to this purpose. The purpose of the lighting lamps in your fridge and/or freezer is to allow you to load your foods in a comfortable and safe manner.

## 6 Care and Cleaning

Service life of the product will extend and frequently encountered problems will decrease if the product is cleaned periodically.



**WARNING:** Switch off the product before cleaning.



**WARNING:** It is recommended to clean the condenser every six months using gloves. You must not use vacuum cleaners.

- Never use gasoline, benzene or similar substances for cleaning purposes.
- Never use any sharp abrasive instruments, soap, household cleaners, detergent or wax polish for cleaning.
- Dissolve one teaspoon of carbonate in half liter of water. Soak a cloth in the solution and wring it thoroughly. Wipe the interior of the refrigerator with this cloth and the dry thoroughly.
- Make sure that no water enters the lamp housing or other electrical parts.
- If you will not use the refrigerator for a long time, unplug it, remove all food inside, clean it and leave the door ajar.
- Check regularly that the door gaskets are clean. If not, clean them.
- Take out all items in the product to remove the door and body shelves.
- Remove the door shelves by pulling them up. Slide the shelves downwards to re-install them after cleaning.
- Never use chloric cleaning agents or water to clean outer surfaces or chrome-coated parts of the product. Chlorine causes abrasion on such metal surfaces.
- For non-No Frost products, water drops and frosting up to a fingerbreadth occur on the rear wall of the Fridge compartment. Do not clean it; never apply oil or similar agents on it.
- Only use slightly damp microfiber cloths to clean the outer surface of the product. Sponges and other types of cleaning cloths may scratch the surface.

### 6.1. Avoiding Bad Odours

Materials that may cause odour are not used in the production of our refrigerators. However, odour may be emitted if foods are stored improperly or if the inner surface of the product is not cleaned as required. Please consider the following to avoid this problem:

- It is important that the refrigerator is kept clean. Food residuals, stains, etc. can cause odour. For this reason, clean your refrigerator with carbonate solved in water every 15 days. Never use detergents or soap.
- Keep your foods in closed vessels. Microorganisms emitted from vessels without a cover may cause unpleasant odours.
- Never keep expired or spoiled foods in your refrigerator.

### 6.2. Protection of plastic surfaces

Do not put liquid oils or oil-cooked meals in your refrigerator in unsealed containers as they damage the plastic surfaces of your refrigerator. If oil is spilled or smeared onto the plastic surfaces, clean and rinse the relevant part of the surface with warm water immediately.

### 6.3. Cleaning the Inner Surface

To clean the inner surfaces and all removable parts, wash them with a mild solution comprising soap, water and carbonate. Rinse and dry thoroughly. Prevent the water from contacting the lighting means and control panel.



**ATTENTION:**

Do not use vinegar, rubbing alcohol or other alcohol-based cleaning agents on any of the inner surfaces.

### 6.4. Stainless Steel Outer Surfaces

Use a stainless steel cleaning agent that is non-abrasive and apply it with a lint-free, soft cloth. For polishing, wipe the surface softly with a damp microfiber cloth and use dry wash-leather. Always follow the strands of the stainless steel.



### 6.5. Cleaning Products with Glass Doors

Remove the protection foil on the glass.

There is a coating on the surface of the glass. This coating minimises stain formation and ensures that stains and dirt are cleaned easily. Glasses that are not protected by a coating might be exposed to permanent bonding of organic or inorganic, air or waterborne pollutants such as limescale, mineral salts, unburned hydrocarbons, metal oxides and silicones, which lead to stains and physical damage in a short time. Despite regular washing, the glass becomes very hard to keep clean, though not impossible. As a result, the clarity and good appearance of the glass reduces. Hard and abrasive cleaning compounds and methods increase these defects even further and accelerate the deterioration process.

\*Non-alkali, non-abrasive and water-based cleaning products must be used for routine cleaning procedures. For the coating to have long service life, alkali or abrasive substances must not be used during cleaning processes.

These glasses were subject to a tempering process to increase their impact and breakage resistance.

As an additional safety measure, there is a safety film on the back surfaces of the glasses to ensure that they will not harm the environment in case of breakage.

If your refrigerator has multizone compartment; before multizone compartment switched from fresh food to freezer, inner surfaces should be cleaned to prevent from any ice accumulation.

Please review this list before calling the service. This will save you time and money. This list contains frequently encountered problems that are not results of faulty workmanship or material use. Your product may not have some of the features described here.

### The refrigerator is not operating.

- It may not be plugged in properly. >>> Plug in the product properly.
- The fuse of the socket to which your refrigerator is connected or the main fuse may have blown. >>> Check the fuse.

### Condensation on the side wall of the fridge compartment (MULTI ZONE, COOL CONTROL and FLEXI ZONE).

- The door may have been opened/closed frequently. >>> Do not open/close the refrigerator door frequently.
- The environment may be too humid. >>> Do not install the refrigerator at locations with a very high level of humidity.
- Foods containing liquid may have been placed into the refrigerator in vessels without covers. >>> Do not place foods containing liquid into the refrigerator in unsealed vessels.
- Door of the refrigerator may have been left ajar. >>> Do not keep the doors of your refrigerator open for a long time.
- The thermostat may have been set to a very cold level. >>> Set the thermostat to an appropriate level.

### The compressor is not operating.

- Protective thermal of the compressor will blow out during sudden power failures or plug-out plug-ins as the refrigerant pressure in the cooling system of the refrigerator has not been balanced yet. The refrigerator will start running approximately after 6 minutes. Please call the Authorised Service Provider if the refrigerator does not start at the end of this period.
- The freezer is in defrosting cycle. >>> This is normal for a refrigerator that performs full-automatic defrosting. Defrosting cycle is performed periodically.
- The refrigerator may not be plugged in. >>> Make sure that the plug fits the socket.
- Temperature settings may be incorrect. >>> Select the correct temperature value.
- Possible power failure. >>> The refrigerator will start to operate normally when power restores.

### The operation noise increases when the refrigerator is running.

- Operating performance of the refrigerator may vary based on the ambient temperature changes. This is normal and not a fault.

### The fridge is running frequently or for a long time.

- Your new product may be bigger than the previous one. Larger refrigerators operate for a longer period of time.
- The room temperature may be high. >>> It is normal that the product operates for longer periods in hot environments.
- The refrigerator may have just been plugged in or loaded with food. >>> It takes the product longer to reach the set temperature when it has just been plugged in or loaded with food. This is normal.
- Large amounts of hot food may have been placed into the refrigerator recently. >>> Do not place hot foods into the refrigerator.
- The doors may have been opened frequently or left ajar for a long time. >>> The warm air that enters the refrigerator causes it to operate for a longer period of time. Do not open the doors frequently.
- Freezer or fridge compartment door may have been left ajar. >>> Check if the doors are closed completely.
- The appliance may be set to a very low temperature. >>> Set the refrigerator temperature to a warmer degree and wait until the product reaches this temperature.
- Door seal of the fridge or freezer compartment may be soiled, worn out, broken or not properly seated. >>> Clean or replace the seal. Damaged/broken seal causes the refrigerator to run for a longer period of time to maintain the current temperature.

### Fridge temperature is adequate but the freezer temperature is very low.

- The freezer compartment temperature may be set to a very low value. >>> Set the freezer compartment temperature to a higher value and check.

### Freezer temperature is adequate but the fridge temperature is very low.

- The fridge temperature is adjusted to a very low value. >>> Adjust the fridge temperature to a higher value and check.

### Food kept in the fridge compartment drawers is frozen.

## Troubleshooting

- The fridge compartment temperature may be set to a very high value. >>> Set the fridge compartment temperature to a lower value and check.

### Temperature in the fridge or freezer is very high.

- The fridge compartment temperature may be set to a very high value. >>> Fridge compartment temperature setting has an effect on the temperature of the freezer. Change the temperature of the fridge or freezer compartment until the fridge or freezer compartment temperature reaches an adequate level.
- The doors may have been opened frequently or left ajar for a long time. >>>Do not open the doors frequently.
- The door may have been left ajar. >>>Close the door completely.
- The refrigerator may have been just plugged in or loaded with food. >>>This is normal. It takes the product longer to reach the set temperature when it has just been plugged in or loaded with food.
- Large amounts of hot food may have been placed into the refrigerator recently. >>>Do not place hot foods into the refrigerator.

### Vibration or noise.

- The floor may not be stable or level. >>>If the refrigerator shakes when moved slightly, adjust the feet to balance it. Make sure that the floor is level and capable of carrying the refrigerator.
- Objects placed onto the refrigerator may cause noise. >>>Remove the objects on the refrigerator.

### There are noises coming from the refrigerator like liquid spilling or spraying.

- Liquid and gas flows occur in accordance with the operating principles of the refrigerator. >>>This is normal and not a fault.

### Whistle is heard from the refrigerator.

- There are fans that are used to cool the refrigerator. This is normal and not a fault.

### Damp accumulates on the inner walls of refrigerator.

- Hot and humid weather increases icing and condensation. This is normal and not a fault.
- The doors may have been opened frequently or left ajar for a long time. >>>Do not open the doors frequently. Close the doors, if open.
- The door may have been left ajar. >>>Close the door completely.

### Humidity occurs on the outer surface of the refrigerator or between the doors.

- Air might be humid. This is quite normal in humid weathers. >>>Condensation will disappear when the humidity level decreases.
- There might be external condensation at the section between two doors of the refrigerator if you use your product rarely. This is normal. Condensation will disappear upon frequent use.

### There is a bad odour inside the refrigerator.

- No regular cleaning may have been performed. Clean the inside of the refrigerator with a sponge, lukewarm water or carbonated water.
- Some vessels or packaging materials may cause the odour. >>>Use another vessel, or packaging materials from another brand.
- Foods may have been placed into the refrigerator in vessels without covers. >>>Store the foods in closed vessels. Microorganisms emitted from vessels without a cover may cause unpleasant odours.
- Take out expired or spoiled foods from the refrigerator.

### The door cannot be closed.

- Food packages may be preventing the door from closing. >>> Re-locate the packages that are obstructing the door.
- The refrigerator may be unstable on the floor. >>>Adjust the refrigerator feet as required to keep the refrigerator in balance.
- The floor may not be level or solid. >>>Make sure that the floor is level and capable of carrying the refrigerator.

### Crispers are stuck.

- Foods may be touching the upper wall of the crisper. >>>Re-organise the foods in the crisper.

### If The Surface Of The Product Is Hot.

High temperatures may be observed between the two doors, on the side panels and at the rear grill while the product is operating. This is normal and does not require service maintenance!

### Fan keeps running when the door is open.

The fan may keep running when the door of the freezer is open.



**WARNING:** If you cannot eliminate the problem although you follow the instructions in this section, consult your dealer or the Authorised Service Provider. Never attempt to repair a malfunctioned product.

## **BEKO UK AND IRELAND STANDARD MANUFACTURER GUARANTEE TERMS AND CONDITIONS**

Your new Beko product is guaranteed against faulty materials, defective components or manufacturing defects.

The standard guarantee starts from the date of original purchase of the product, and lasts for a period of twelve (12) months unless Beko plc (the "Manufacturer") agrees to extend the guarantee for the product in writing.

If you have purchased an American style Fridge freezer, the standard guarantee starts from the date of original purchase of the product, and lasts for a period of twenty four (24) months unless Beko plc (the "Manufacturer") agrees to extend the guarantee for the product in writing.

If you have any questions about the guarantee on your product (including how long it is valid), please contact your retailer or our contact centre on

**0333 207 971** (UK and Northern Ireland) or **01 862 3411** (Republic of Ireland)

This guarantee does not in any way diminish or affect your statutory rights in connection with the product. This guarantee is in addition to your statutory rights as a consumer. If you have any questions about these rights, please contact the retailer from which you purchased the product. In certain circumstances, it is possible that your statutory rights may offer additional or higher levels of protection than those offered under the terms of this guarantee.

### **What is covered by this guarantee?**

- Repairs to the product required as a result of faulty materials, defective components or manufacturing defects.
- Functional replacement parts to repair a product.
- The costs of a Beko Approved Engineer to carry out the repair.

### **What is not covered?**

- Transit and delivery damage.
- Cabinet or appearance parts, including but not limited to control knobs, flaps and handles.
- Accessories and/or consumable items including but not limited to ice trays, scrapers, cutlery baskets, filters and light bulbs.
- Repairs necessary as a direct or indirect result of:
  - Accidental damage, misuse or abuse of a product.
  - An attempted repair of a product by anyone other than a Beko Approved Engineer (the "Engineer").
  - Installation or use of a product where such installation or use fails to meet the requirements contained in this guarantee or the User Instructions Booklet.
- Repairs to a product operated at any time on commercial or non-residential household premises (unless we have previously agreed to the installation environment).

This guarantee is limited to the cost of repairing the product. To the extent permitted by law, the Manufacturer does not accept and will not be held liable for any financial loss incurred in connection with the failure of any product to operate in accordance with the expected standards. Such financial loss includes but is not limited to loss arising from:

- Time taken off work.
- Damaged food, clothing or other items.
- Meals taken at restaurants or from takeaways.
- General compensation for inconvenience.

## **Important Notes**

- 1.** Your product is designed and built for domestic household use only.
- 2.** The guarantee will automatically be void if the product is installed or is used in commercial or non-residential domestic household premises, unless we have previously agreed to the installation environment.
- 3.** The product must be correctly installed, located and operated in accordance with the instructions contained in the User Instructions Booklet provided with your product.
- 4.** Professional installation by a qualified Electrical Domestic Appliance Installer is recommended for all Washing Machines, Dishwashers and Electric Cookers (as incorrect installation may result in you having to pay for the cost of repairing the product).
- 5.** Gas Cookers must be professionally installed by a Gas Safe (or Gas Networks Ireland for Republic of Ireland) registered gas installer.
- 6.** This guarantee is given in respect of products purchased and used within the United Kingdom and the Republic of Ireland.
- 7.** This guarantee is effective from the initial date of purchase of a new product from an authorised retailer and will be void if the product is resold.
- 8.** This guarantee does not apply to graded sales (where the product is purchased as a "second").
- 9.** Possession of a copy of these terms and conditions does not necessarily mean that a product has the benefit of this guarantee. If you have any questions, please call our Call Centre on the number set out above.
- 10.** The Manufacturer reserves the right to terminate the guarantee if its staff or representatives are subjected to physical or verbal abuse in the course of carrying out their duties.
- 11.** Optional extras, where available (i.e. extendable feet) are supplied on a chargeable basis only.

## **Does Beko offer replacements?**

This is a repair-only guarantee. On occasion, the Manufacturer may at its sole discretion, replace your product with a new product instead of carrying out a repair. Where a replacement is offered, this would normally be an identical model but when this is not possible, a model of similar specification will be provided. The Manufacturer will cover the costs and arrange for the delivery of the new product and for the return of the old product. Any costs related to disconnecting the faulty product and installing the replacement product will not be borne by the Manufacturer unless previously agreed to in writing. The original guarantee will continue to apply to the replacement product; the new product will not come with a new guarantee.

## **When will the repair take place?**

Our Engineers work Monday to Friday 9.00am to 5.00pm. Appointments outside these hours may be possible at the sole discretion of the Manufacturer but cannot be guaranteed. Whilst our Engineers will endeavour to minimize inconvenience and to meet requests for specific timed appointments, this cannot be guaranteed. We will not be liable for delays or if it is unable to carry out a repair because a convenient appointment cannot be arranged.

## **Will there be any charge for the repairs?**

It is your responsibility to provide evidence to the Engineer that your product is covered by this guarantee with a proof of purchase. The Manufacturer reserves the right to charge for the reasonable cost of any service call if:

- You cannot provide evidence that your product is covered by this guarantee.
- Where a service call has been made and the engineer finds that there is no fault with your product.
- That your product has not been installed or operated in accordance with the User Instructions Booklet.
- That the fault was caused by something other than faulty materials, defective components or manufacturing defects.

- For missed appointments.

Payment of these costs are due immediately upon the Engineer providing you with an invoice. The Manufacturer reserves the right to terminate the guarantee if you fail to pay the costs for the service call in a timely manner.

If you are a resident of the United Kingdom, this guarantee will be governed by English law and subject to the English Courts, save where you live in another part of the United Kingdom, in which case the law and courts of that location will apply.

If you are resident in the Republic of Ireland, this guarantee will be governed by Irish law and the Irish courts will have jurisdiction.

This guarantee is provided by Beko plc. Beko House, 1 Greenhill Crescent, Watford, Hertfordshire. WD18 8QU.

Beko plc is registered in England and Wales with company registration number 02415578

### **BEKO UK AND IRELAND BUILT-IN APPLIANCES GUARANTEE TERMS AND CONDITIONS**

If you have purchased a built-in or integrated appliance, and registered it within 90 days of purchase by completing the online registration form, then the standard 12 month guarantee will be extended to 24 months, under the same terms and conditions as detailed in our Standard Guarantee Terms and Conditions.

Beko Free standing appliances come with a 12 month parts and labour guarantee as standard,

Beko Built-in appliances come with a 12 month parts and labour guarantee as standard. This is extended to 24 months, free of charge, upon registration of the appliance. When you register your appliance for additional guarantee, you will automatically activate the ProSmart Motor 10 year guarantee. You do not need to register twice. ([beko.co.uk/guarantee-terms](http://beko.co.uk/guarantee-terms)).

To make a claim against your Beko ProSmart Inverter Motor Guarantee (the "Guarantee"), all customer and product details must be registered with Beko plc using the procedure outlined below.

- 1.** This extra 9 years (for free standing appliances) or 8 years (for built-in or integrated appliances) guarantee is only effective after the expiration of the standard manufacturer's guarantee.
- 2.** It is only valid for the ProSmart Inverter motors of selected washing machines, washer-dryers, tumble dryers and dishwashers. It does not cover any labour charge or any other components of the product. In addition, it is only valid for one replacement of the ProSmart motor during the extra 9-year (for free standing appliances) or 8 year (for built-in appliances) guarantee period.
- 3.** To activate your guarantee, you **MUST** register your appliance within 90 days of the original purchase date, by visiting [beko.co.uk/register](http://beko.co.uk/register).
- 4.** Customers will receive a unique reference code as proof of guarantee validation by email or post, which must be quoted at the time of a claim being made.
- 5.** Any repair/replacement of the ProSmart Inverter motor must only be carried out by an authorised Beko Service Agent (the "Service Agent").
- 6.** Labour for the repair/replacement of the ProSmart Inverter motor is not included in this guarantee and is chargeable directly by the Service Agent.
- 7.** Any additional components fitted to the product at any time will not be covered by this guarantee and will be chargeable directly by the Service Agent.
- 8.** The guarantee is not transferable and cannot be exchanged for cash.
- 9.** There are no alternative or additional offers to this Guarantee.
- 10.** The guarantee is exclusive of the manufacturer's standard guarantee
- 11.** The Terms and Conditions shown above are in addition to the standard terms and conditions of your product guarantee. Please read and refer to such Terms and Conditions when making any claim.
- 12.** We may use the information you provide for marketing purposes and to analyse your purchasing preferences. We may keep your information for a reasonable period for these purposes in accordance with the applicable Data Protection Laws and General Data Protection Regulations (GDPR). You can opt into this service during the registration process. Further details are available at <http://www.beko.co.uk/cookie-and-privacy>.
- 13.** These Terms and Conditions are governed by the laws of England and Wales; manufacturer: Beko plc, Beko House, 1 Greenhill Crescent, Watford WD18 8QU. Company Registration Number: 02415578.

## HOW TO OBTAIN SERVICE FOR YOUR APPLIANCE

Please keep your purchase receipt or other proof of purchase details in a safe place; you will need to have this documentation available should the product require attention under guarantee.

Please take a few moments to complete the details below, as you will need this information when you call us, or to use our online services. When you call us you may be required to input your serial number into your telephone keypad. For help please visit [beko.co.uk/support/model-finder](http://beko.co.uk/support/model-finder)

- The product model number is printed on the Operating Instruction Booklet / User guide
- The product model and serial number is printed on the Rating Label affixed to the appliance.
- The Retailer (Purchased from) and Date of purchase will be printed on your purchase receipt or other proof of purchase paperwork

Recording of these details alone will not count as proof of purchase. A valid proof of purchase is required for requesting service under guarantee.

Model number	Serial number	Purchased from	Date of purchase

### For service under guarantee or for product advice please call our Contact centre

Before requesting service please check the troubleshooting guide in the Operating Instructions booklet, as a charge may be levied where no fault is found, and even though your product may still be under guarantee.

After arranging service the area around the product must be easily accessible to the Engineer, without the need for cabinets or furniture to be removed or moved.

It is your responsibility to ensure our Engineers have a clean and safe environment to carry out any repairs.

Please have your Model number and Serial number available when you call us, as you may be required to input your serial number into your telephone keypad during your call.

### UK Mainland & Northern Ireland:

**0333 207 9710**

*Landline or mobile calls to 0333 numbers cost no more than calls to geographic numbers 01 or 02, and are charged at the basic rate. Calls from landlines and mobiles are included in free call packages but please check with your telephone service provider for exact call charges.*



**Republic of Ireland:**

**01 862 3411**

**Service once the manufacturers guarantee has expired**

*If you have purchased an extended guarantee please refer to the instructions contained within the extended guarantee agreement document, otherwise please call us using the appropriate number above, where service can be obtained at a charge.*

Should you experience any difficulty in obtaining service please call us on **0333 207 9710** or **01 862 3411**

**Contact us through our website**

Send us a secure message through our online contact us form. Please visit our website, click Contact Us and choose a product support topic from the list of options. Complete the required details and click send message.

**Product registrations**

For UK registrations please visit [beko.co.uk/register](http://beko.co.uk/register) and for the Republic of Ireland visit [beko.ie/register](http://beko.ie/register).