

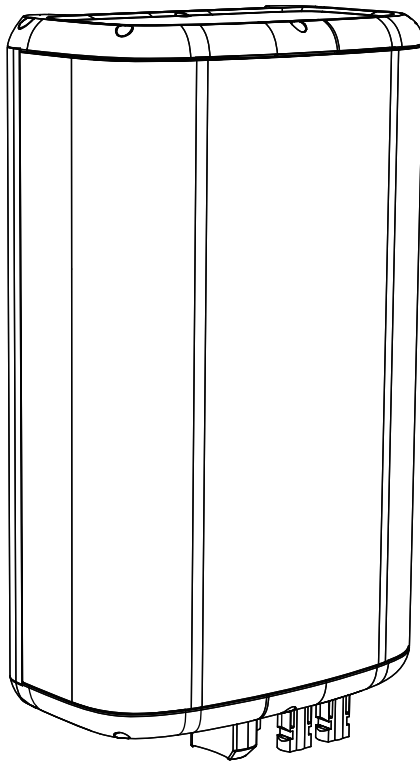

BLUETTI



D300S PV DROP DOWN MODULE

Please read this manual before use and follow its guidance. Keep this manual for future reference.

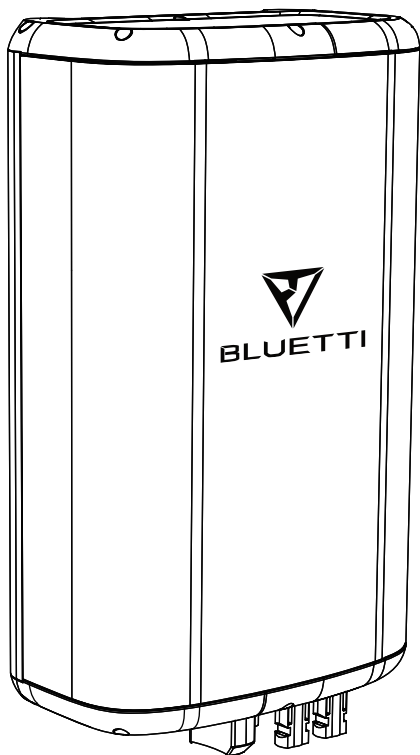

USER MANUAL

Please read this manual before use and follow its guidance. Keep this manual for future reference.

Contents

BRIEF INTRODUCTION.....	01
WHAT`S IN THE BOX.....	01
FEATURES OF D300S.....	02
INSTALLATION	03
TECHNICAL SPECIFICATIONS	06
SAFETY INSTRUCTION.....	07
DECLARATION.....	08

BRIEF INTRODUCTION

D300S created by BLUETTI Tech Team to allow your EP500/Pro, AC300 to have a chance to connect with Roof/Rigid panels for 2400W Max. Solar charging, especially users who already have installed rigid solar panels and PV grid-connected inverters, and the solar panel array's total open-circuit voltage exceeds the EP500/Pro, AC300 input limit(140V/150V), D300S will be perfect to adjust the total voltage and match the input requirements of EP500/Pro, AC300.

WHAT`S IN THE BOX

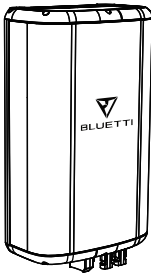

D300S PV Drop Down Module
x1 pcs

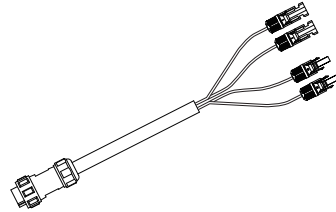

DC Output Cable(Aviation to MC4*2)
x1 pcs



User Manual
x1 pcs

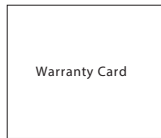

Warranty Card
x1 pcs



Certificate of QC Pass
x1 pcs

FEATURES OF D300S

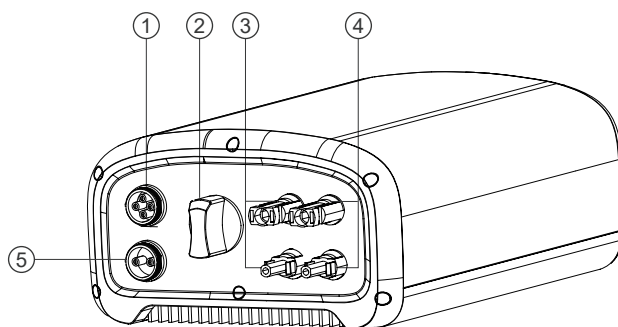
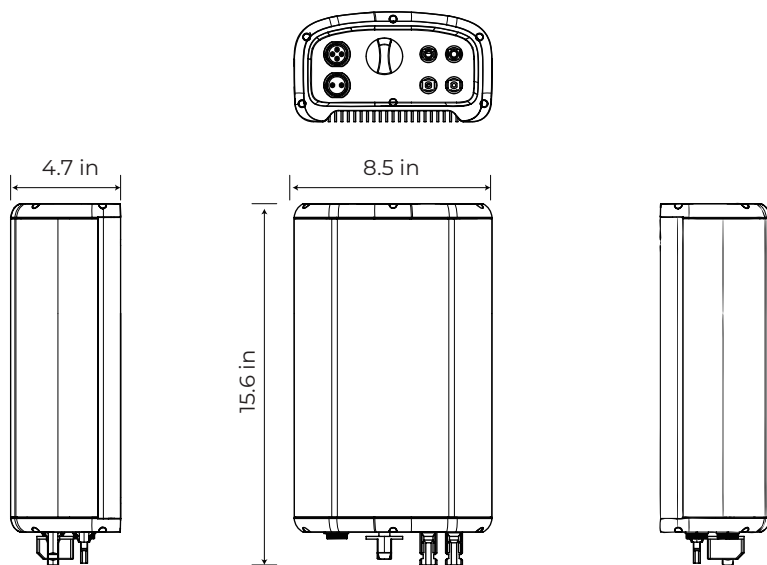

- 01** Output Port: connect to power the power station.
- 02** Main Switch of D300S: please turn OFF during installation.
- 03** NO1. MPPT(PV1 indicates DC1,Connect with your solar panels)
- 04** NO2. MPPT(PV2 indicates DC2,Connect with your solar panels)
- 05** Expansion Port: For future updating via 485 communication port.

INSTALLATION

Step1.

Please turn OFF the switch.

The Main Switch of D300S is kept in the OFF state to ensure safety during installation.

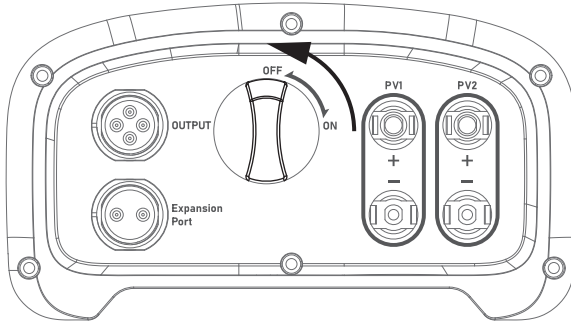

Step2.

For EP500Pro/AC300, set DC1/DC2 Input Source to Others, and set PV Parallel Enable to OFF. (Mainpage - Settings)

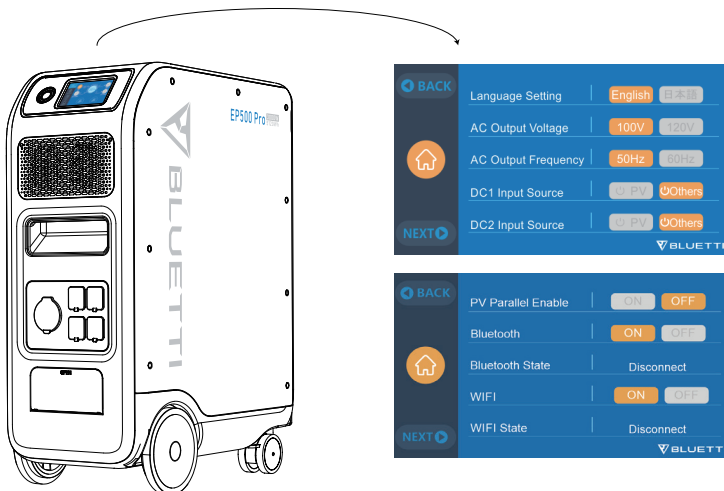

Step3.

The roof solar panels are connected to D300S as shown in the figure. Please make sure that one set of solar panels is connected to PV1, and the other set of solar panels is connected to PV2. Be careful not to mix them.

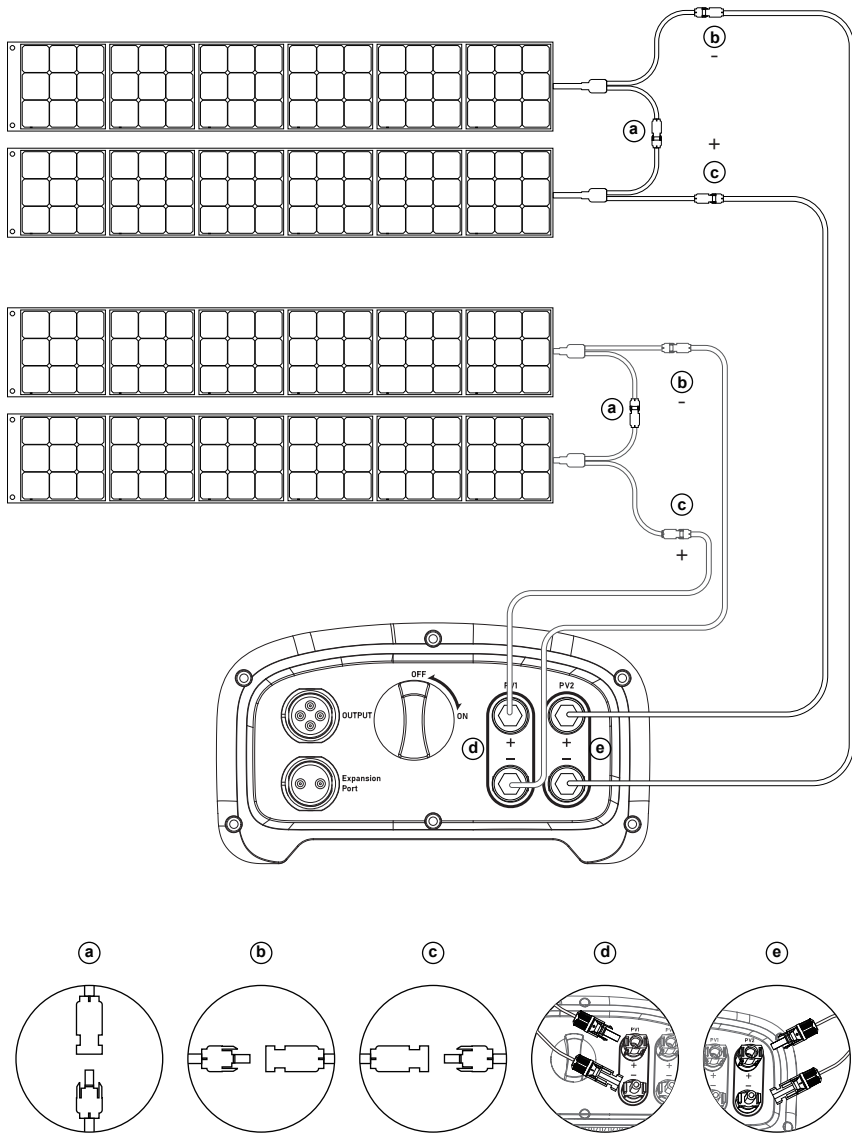

Example for rigid panels connecting to D300S in parallel.

Just Power on

Step4.

Connect EP500Pro with D300S with DC Output Cable(Included).

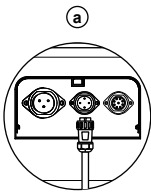
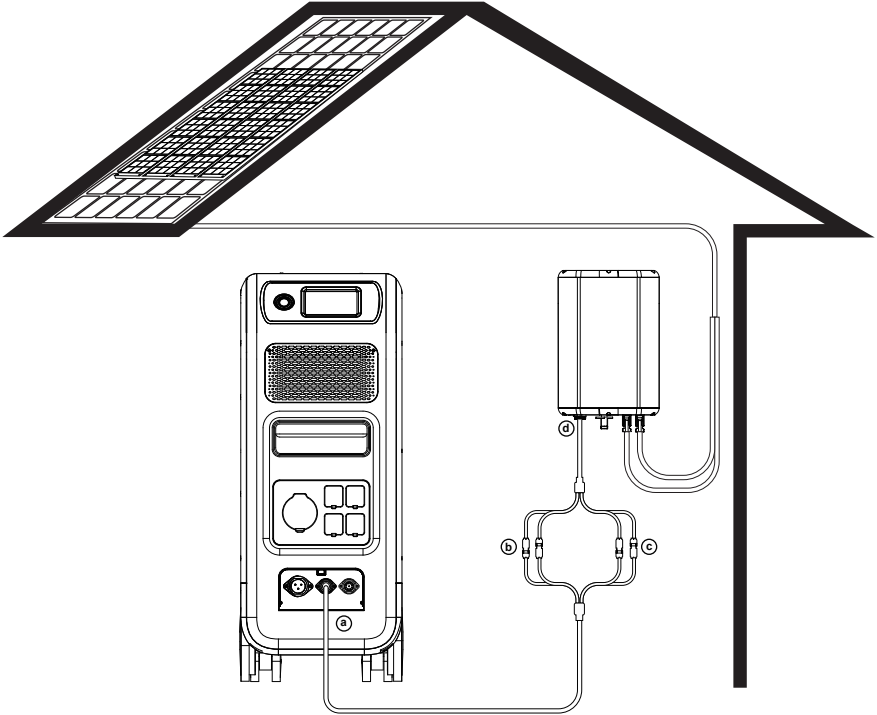

a.DC Output Cable to EP500Pro
b.DC1 poles to PV1 poles

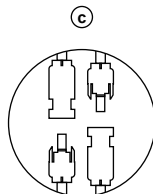
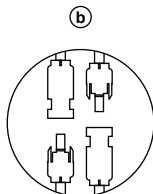

c.DC2 poles to PV2 poles
d.DC Output Cable to D300S

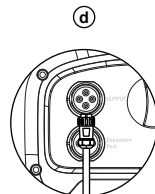

Step5.

Turn the main switch from OFF to ON to activate the solar charging system.

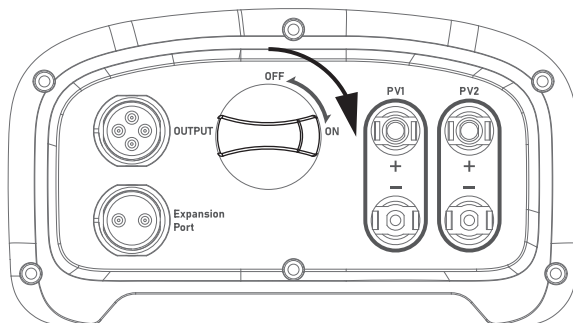

TECHNICAL SPECIFICATIONS

List	Min.	Rated	Max.	Note
DC output				
Power of Output	/	/	3000W	/
Voltage	65V	115V	135V	/
Current	/	/	26A	/
Short-circuit Protection	Supported			
PV input				
Power of Input	/	/	3000W	/
MPPT Voltage	120V	360V	500V	Open circuit voltage 550V
Current	/	/	15A	
Dual MPPT	Supported			Dual MC4 Plugs
Internal Over-heated	/	85 °C	/	
Radiator Over-heated	/	95 °C	/	
Short-circuit Protection	Supported			<20VDC
Max. Efficiency	97.8%			
Output Over-voltage Protection	>140VDC			Stop Output Function

Ambient Temp.	-10 C	25 C	40 C	
Storage Temp.	-20 C	25 C	40 C	No condensation
Altitude	< 2000m			
Protection Level	IP54			
Dimensions	396*216*120mm/15.6*8.5*4.7in			
Net Weight	7KG/15.4lb			

SAFETY INSTRUCTION

Please check whether D300S is damaged, cracked, liquid leakage, heat or other abnormalities or AC line is damaged before operating. If any, please stop using the product immediately and contact the seller;

- Keep a distance of 50mm between D300S and other objects.
- Avoid exposing to direct sunlight when the solar system is working and DO NOT place the D300S near heat sources.
- It is prohibited to place the equipment in an environment with flammable, explosive gas, or smoke. Since D300S relies on the shell to dissipate heat, over-temperature of the shell will lead to damage.
- DO NOT attempt to replace the internal components of the equipment by any unauthorized personnel.
- DO NOT operate in wet conditions. Please let the unit dry completely before using if the equipment becomes wet.
- Please ensure proper ventilation while in use, inadequate ventilation may cause permanent damage to the equipment.
- Do not place anything on the top of D300S, please install it where people cannot touch it.
- DO NOT move the unit while operating as vibrations and sudden impacts may lead to poor connections to the hardware inside.
- In case of fire, only a dry powder fire extinguisher is suitable for the product.
- For safety purposes, please use only the original charger and cables designed for the equipment. We are not liable for damage caused by third-party equipment and may render your warranty invalid.

DECLARATION

- Due to product improvement, some changes in appearance and specifications may be made without extra statement.
- No compensation for damages shall be made for utilizing non-standard adapters and accessories.
- BLUETTI shall not be liable for damage caused by force majeure factors such as fire, typhoon, flood and earthquake, or intentional negligence, misuse, or use under other abnormal conditions.
- BLUETTI shall not be liable for any damages caused by operating the product not in accordance with the method of use in the instruction manual.
- D300S is not suitable for the use on the relevant equipment or machines involving:
- Personal safety, such as atomic energy devices, Hi-Fi player, emergency medical devices, etc., or any equipment or machines that require extremely highly reliable power sources. We are not responsible for accidents, fires, wrongful or negligent actions caused by such equipment or machines which results in damage.

EU	REP
-----------	------------

Company: POWEROAK GmbH
Address: Lindwurmstr. 114, 80337 München Germany
Mail: logi@bluetti.de

UK	REP
-----------	------------

Company: POWEROAK ENERGY UK CO.,LTD
Address: Suite 108 Chase Business Center 39-41 Chase Side London United
Kingdom N14 5BP
Mail:poweroak.eu@bluetti.com