

# AC300

# Portable Power Station

## User Manual v5.0

Please Read This Manual Before Use And Follow Its Guidance.  
Keep This Manual For Future Reference.



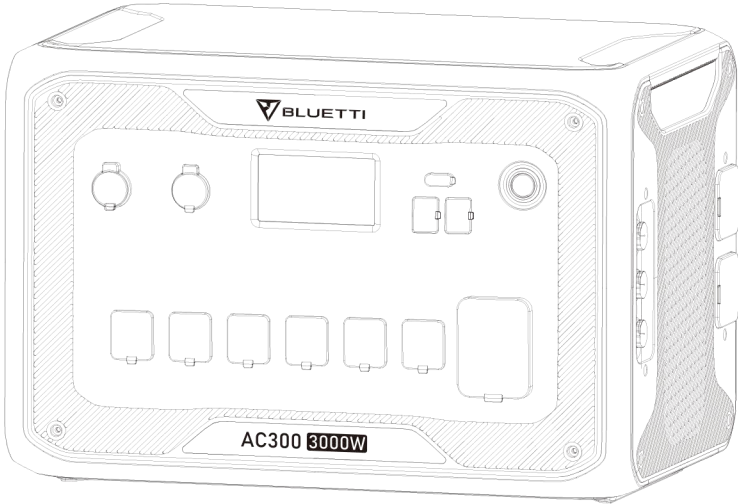

# Thank You

Thank you for making BLUETTI a part of your family.

From the very beginning, BLUETTI has tried to stay true to a sustainable future through green energy storage solutions for both indoor and outdoor use while delivering an exceptional eco-friendly experience for our homes and our world.

That's why BLUETTI makes its presence in 70+ countries and is trusted by millions of customers across the globe.



# Contents

1	Safety Instructions .....	05
1.1	General Safety .....	05
1.2	Handling .....	07
1.3	Storage and Usage .....	07
2	What's In The Box .....	08
3	Product Overview .....	11
3.1	Diagram .....	11
3.2	Specifications .....	12
4	Operation .....	13
4.1	Powering On/Off .....	12
4.2	LCD Screen .....	12
4.3	Charging .....	18
4.4	Discharging .....	24
4.5	Capacity Expansion .....	25
4.6	UPS .....	27
4.7	BLUETTI App .....	33
4.8	Split Phase System .....	37
5	Appendix .....	38
5.1	FAQs (Frequently Asked Questions) .....	38
5.2	FCC Warning .....	39
5.3	Technical Support .....	40

# 1. Safety Instructions

Read this manual for instructions on the proper use and safety information for the unit. Follow the warnings and instructions marked on the unit and its accessories.

Pay attention to the "Instruction", "Caution", "Warning" and "Danger" symbols in this manual, and follow the instructions carefully to avoid injury or damage.

The Safety Requirements provided herein are for illustrative purposes that include but are not limited to those listed in this manual. Actual operation shall comply with all applicable safety standards.

If you have any questions, feel free to contact BLUETTI support or your local BLUETTI dealers.

## 1.1. General Safety

- Always operate or store the unit in the conditions specified in this manual.
- The installation and ambient conditions must comply with the regulations in the relevant international, national or regional standards.
- Unauthorized disassembly, alteration of the equipment or modification of the software code is not allowed.

### **BLUETTI shall not be liable for the following circumstances:**

- Equipment damage caused by force majeure, such as earthquake, fire, storm, flood, mudslide, etc.
- Damage or loss during transportation.
- Damage caused by storage conditions that do not meet the requirements specified in this manual.
- Damage to the hardware or data of the equipment due to customer negligence, improper operation or intentional damage.
- Damage to the system caused by a third party or the customer, including handling and installation that does not meet the requirements specified in this manual.
- This product is not suitable for providing electrical service for equipment and machines that are highly dependent on the reliability of electrical power supply and that involve personal safety, such as atomic energy, aviation, medical, etc. Poweroak will not be held responsible for any personal safety accidents, fire accidents, equipment failures, etc. caused by using this product to supply power to the above equipment and machines.
- Damage caused by adjustment, alteration or removal of identification marks.

### **To avoid danger, please regulate the operation in the following manner:**

- Do not install, use and maintain the unit in adverse weather conditions such as lightning, rain, snow and strong breezes (including but not limited to handling and operating the unit, plugging and unplugging signal connections to outdoor facilities, working at height, outdoor installations, etc.).

- Always turn off the power source before starting any electrical work.
- Do not clean the unit with water.
- Do not disassemble, modify, tamper with or repair the unit on your own.
- Regularly inspect the unit and its accessories for damage or deterioration.
- Use a tester to check for the presence of dangerous voltage before touching any conductor or terminal.
- If the unit's shell is cracked during transportation or use, do not use it and contact BLUETTI support or your local BLUETTI dealers.
- Use a dry powder extinguisher if the unit catches fire.
- In case of fire, EVACUATE the building or affected area immediately, activate the closest FIRE ALARM system and CALL 9-1-1 or your local emergency phone number.
- Use genuine cables and accessories provided by BLUETTI.
- Keep the unit away from heat sources or high temperatures, and do not expose it to direct sunlight.
- Do not store the unit with flammable liquids, gases, or explosive materials.
- Make sure the area where you are using the unit is well ventilated and spacious.
- Do not block or cover the vents of the unit as this may cause irreversible damage to it.
- Use the unit for its intended purpose and avoid stacking objects on top of it during storage or use.
- Do not move the unit during operation as the vibrations and shocks associated with movement may cause damage to the internal hardware.
- In case of malfunction, turn off the unit immediately and contact BLUETTI support or your local BLUETTI dealers if this manual cannot adequately explain the malfunction to you.
- Do not place the unit on an unstable or inclined surface.
- Do not insert foreign objects into any port and vent of the unit.
- Keep away from children and pets.

### Legal and Regulatory Requirements

- The transportation, wiring and maintenance shall comply with all applicable laws, regulations and standards.
- User-provided materials and tools required shall meet the requirements specified in applicable laws, regulations and relevant standards.

## 1.2.Handling

Use mechanical assistance as needed (e.g. trolleys and adjustable height workbenches).

### Recommended number of people based on the weight of product

Weight	Number of people
<18kg	1
18kg~32kg	2
32kg~55kg	3
>55kg	4 or a cart

## 1.3. Storage and usage

- When not using the unit for over 3 months, charge it to 40% to 60% SoC to keep it in optimal condition.
- Before storing the unit, power it off and remove all electrical connections from it.
- Store the unit in a cool and dry place. The ideal temperature range is 10°C to 30°C. The unit can be safely charged and discharged at temperatures of -20°C to 40°C. However, it's NOT recommended to store the unit in harsh temperatures for extended periods of time.
- Fully cycle the unit every 6 months to maintain the battery's health.

If the SoC drops to 0 (during operation or upon startup), take the following actions to safely restart the unit:





- 1)Shut down immediately.
- 2)Charging within 48 hours.
- 3)Battery should be kept at an ambient temperature of 5°C to 35°C for 24 hours before charging.

It is recommended to charge the unit via an AC source. If charging via solar energy, ensure that your solar system provides an output of more than 100W.

BLUETTI shall not be liable for any equipment damage caused by the violation of above instructions.

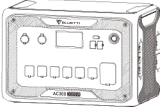
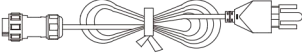
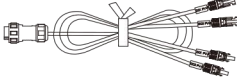
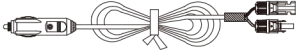



## 2. What's In The Box

### Standard Packaging

Item	Picture	Qty.
Portable Power Station		1
15A AC Charging Cable		1
DC Input Cable		1
Car Charging Cable		1
User Manual		1
Warranty Card		1
Quality Certificate		1

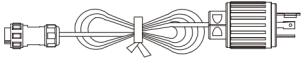
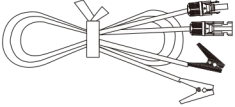

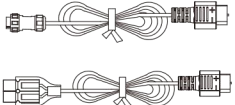
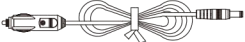
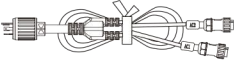
## Optional

Item	Picture
30A AC Charging Cable	 A coiled black AC charging cable with a standard three-pronged AC plug on one end and a rectangular 30A DC connector on the other.
Lead-acid Battery Charging Cable	 A coiled black cable with a cigarette lighter-style DC connector on one end and two alligator clips on the other.
D300S PV Voltage Step Down Module	 A rectangular white electronic module with the brand name 'BLUETTI' and a logo on the front. It has several ports on the bottom edge.
30A RV Cable	 Two coiled black cables. The top one has a cigarette lighter-style DC connector on one end and a rectangular 30A DC connector on the other. The bottom one has two alligator clips on one end and a rectangular 30A DC connector on the other.
Cigarette Lighter-F to DC5521 Cable (24V)	 A coiled black cable with a cigarette lighter-style DC connector on one end and a rectangular DC5521 connector on the other.
Split-phase AC Charging Cable	 A coiled black cable with a standard three-pronged AC plug on one end and a rectangular DC connector on the other.
USB-C to USB-C Cable	 A coiled black cable with USB-C connectors on both ends.

---

Communication Cable

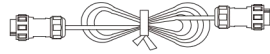

---

P150D to P090D Cable

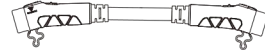

---

P030A Fusion Box

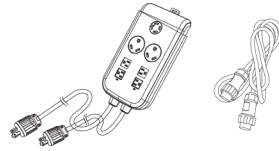

---

\* The optional accessories are not included in standard packaging and can be purchased separately at <https://www.bluetipower.com/>.

**15A AC Charging Cable:** 59in/150cm.

**DC Input Cable:** 59in/150cm. Aviation-MC4.

**Car Charging Cable:** 20in/50cm. Cigarette Lighter Port-MC4.

**30A AC Charging Cable:** 59in/150cm.

**Lead-acid Battery Charging Cable:** 20in/50cm. Clamp-MC4.

**D300S PV Voltage Step Down Module:** 59in/150cm(output cable).

**30A RV Cable:** Aviation-XT90, 31.5in/80cm;  
XT90-SPC45, 20in/50cm.

**Cigarette Lighter-F to DC5521 Cable(24V):** 38in/72cm.

**Split-phase AC Charging Cable:** 59in/150cm.

**USB-C to USB-C Cable:** 79in/200cm.

**Communication Cable:** 59in/150cm.

**P150D to P090D Cable:** 31.5in/80cm.

**P030A Fusion Box:** 122in/310cm; 73in/185cm.

**Note:** All measurements are for reference only.

Package details are subject to change without prior notice.

### 3. Product Overview

#### 3.1 Diagram

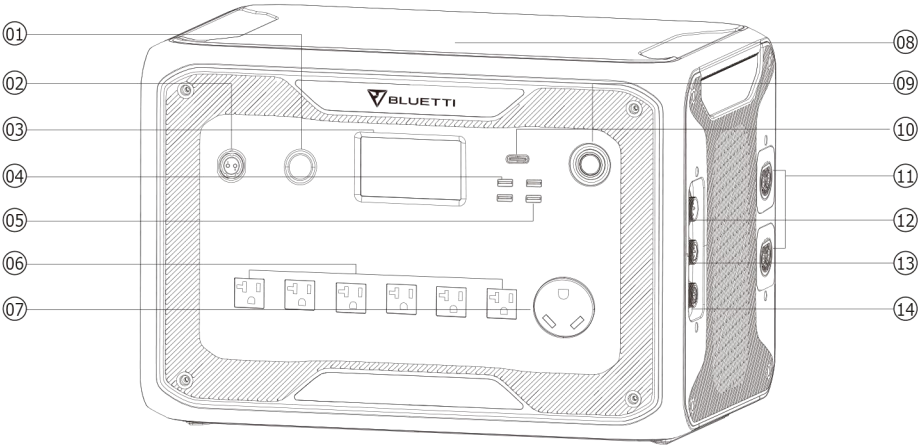

- |                                   |                                     |
|-----------------------------------|-------------------------------------|
| 1. 24V/10A Cigarette Lighter Port | 8. Wireless Charging Pad            |
| 2. 12V/30A Port                   | 9. Power Button                     |
| 3. LCD Screen                     | 10. USB-C(PD3.0 protocol supported) |
| 4. USB-A (fast charging)          | 11. Battery connection port         |
| 5. USB-A                          | 12. AC Input Port                   |
| 6. AC Output Port(20A MAX)        | 13. DC1/DC2 Input Port              |
| 7. AC Output Port(30A MAX)        | 14. Communication Interface         |

### 3.2 Specifications

AC300		
General		
Battery Capacity (With 1-4 B300)	3072Wh~12288Wh/60Ah~240Ah	
Dimensions (L*W*H)	20.5in×12.8in×14.1in/520mm×325mm×358mm	
Weight	47.6lbs/21.6kg	
Discharging Temperature	-4°F~-104°F/-20°C~40°C	
Charging Temperature	32°F~104°F/0°C~40°C	
Storage Temperature	-4°F~104°F/-20°C~40°C	
Over Temperature Protection (With B300S)	Discharging	65°C (Recovery at 55°C)
	Charging	55°C (Recovery at 45°C)
Working Humidity	10%~90%	
AC Output		
Power	3000W	
Surge	6000W	
Voltage	120V	
Current	25A	
Frequency	50/60Hz	
Overload	3100W~3750W, 2min	
	3750W~4500W, 5s	
	4500W~6000W, 500ms	
DC Output		
Cigarette Lighter Port *1	Voltage	24VDC
	Current	10A
12V/30A RV *1	Voltage	12V
	Current	30A
	Overload	418W, 2s
USB-A *2	Voltage	5V
	Current	3A
USB-A QC3.0 *2	Power	18W Max. (5V/3.6A, 9V/2A, 12V/1.5A)
USB-C PD3.0 *1	Power	100W Max. (5/9/12/15/20V, 3A; 20V, 5A)
Wireless Charging *2	Power	15W Max.

AC Input	
Power	3000W Max.
Voltage	120V
Current	30A Max.
DC Input	
Power	1200W*2
Voltage	12V~150V
Current	12A*2
<b>Note:</b> With the 15A AC charging cable, the combo gets a maximum of 1800W AC input.	

## 4. Operation

### 4.1 Powering On/Off

Powering on: Press the power button either on AC300 or B300 and hold for at least 1s to start up the combo.

AC/DC Output: Tap the 'AC ON/OFF' or 'DC ON/OFF' to enable or disable.

Operation	Green Light(On the Buttons)	LED Indicator(On B300S)
Powering On	ON	ON
Powering Off	OFF	OFF

**Note:** Turn on the DC power to enable wireless charging.

When connected to the grid or PV, the combo turns on automatically.

Powering Off: Press the power button either on AC300 or B300 to shut down the combo.

### 4.2 LCD Screen

#### 4.2.1. Homepage

Tip: It's recommended to touch the LCD resistive touchscreen lightly with the edge of your fingernail until it "beeps" when it registers a press.

**NOTE:** Touch sound can be turned ON/OFF in the Settings menu.

The pictures of the LCD screen are for reference only. The actual product may be different.

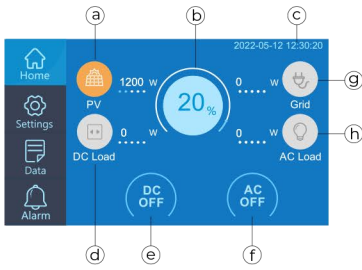

a: PV Input

e: DC ON/OFF

b: Battery Level

f: AC ON/OFF

c: Date/Time

g: Grid Input

d: DC Load

h: AC Load

## 4.2.2. Settings

Tap Settings on the homepage to enter the settings page.

### • Page 1

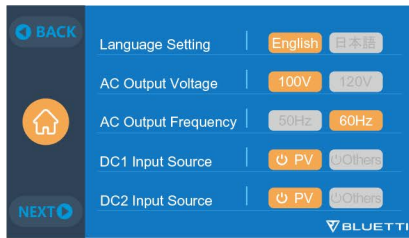

Language Setting: Tap to select the system language of AC300

AC Output Voltage: Tap to select the AC output voltage of AC300

AC Output Frequency: Tap to select the AC output frequency of AC300

**Note:** Please check the output voltage, frequency, and other parameters BEFORE first use. AC frequency and voltage can only be adjusted after the AC output is turned off. (Tap the AC icon on homepage to turn OFF AC output).

DC1 Input Source & DC2 Input Source: Tap to select PV or Others as the input source.

AC300 features dual MPPT charge controllers for a maximum of 2400W solar input. Along with the DC input cable, it supports two DC input sources simultaneously, namely DC1 and DC2. DC1/DC2 consists of both positive and negative poles of the MC4 plugs.

Can be set on the touchscreen:  
Homepage-Settings-DC1/DC2  
Input Source

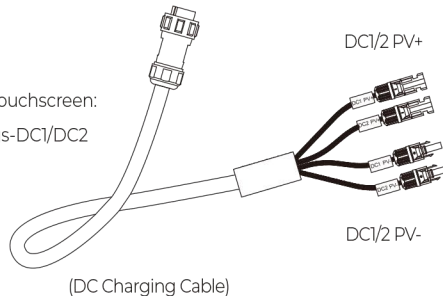

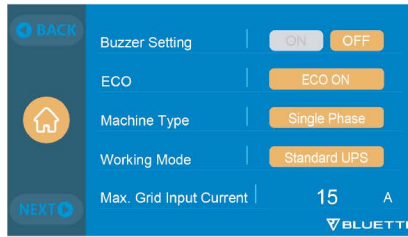

Buzzer Setting: Tap to enable/disable the alarm sound.

ECO: Tap to enable/disable the ECO mode.

**Note:** When in ECO mode, the AC output will automatically turn OFF after 4-hour low (<=30W) or no load to save power.

Machine Type: Tap to set the machine type to Single Phase or Split Phase. Refer to Split Phase System in this manual for more details.

Working Mode: Tap to set the UPS working mode to Standard UPS, Time Control UPS, PV Priority UPS or Customized UPS. Refer to UPS section in this manual for more details.

**Note:** The AC300+B300 is set to Standard UPS Mode by default.

Max. Grid Input Current: Tap to set the maximum grid input current.

Warning: Consider the specifications of utility grid, AC outlet and charging cable before setting the Max. Grid Input Current. BLUETTI shall not be liable for any damages, injuries, or other liabilities directly or indirectly from the setting changes.

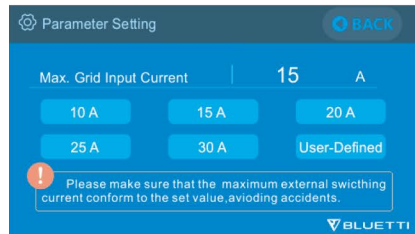
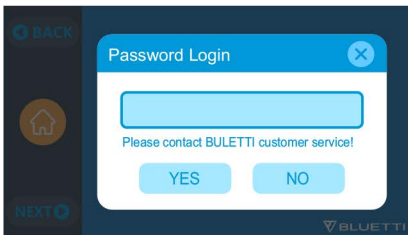
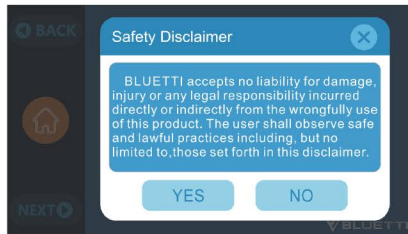

**Note:** When the current exceeds the preset value, AC300 will take charge to be the power source of the circuit.

The Gird Input Current is set at 15A by default. The change only takes effect when AC300 connects to the gird. Email BLUETTI Customer Service for the password.

• Page 3



PV Parallel Enable: Tap to enable/disable PV Parallel mode.

Bluetooth: Tap to turn ON/OFF Bluetooth.

Bluetooth State: Showing the state of Bluetooth.

WIFI: Tap to turn ON/OFF Wi-Fi.

WiFi State: Showing the state of Wi-Fi.

**Note:** AC300 can not be connected to BLUETTI App when both of the Wi-Fi and Bluetooth functions are disabled.

• Page 4

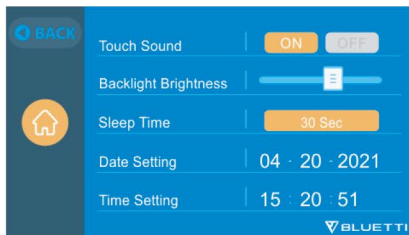

Touch Sound: Tap to enable/disable the touch sound.

Backlight Brightness: Slide to adjust the brightness of the screen.

Sleep Time: Tap to choose how long the screen stays on when it's not being interacted with.

Date Setting & Time Setting: Tap the adjust the Date and Time.



### 4.2.3. Data

Tap "Data" on the Homepage to enter the settings interface.

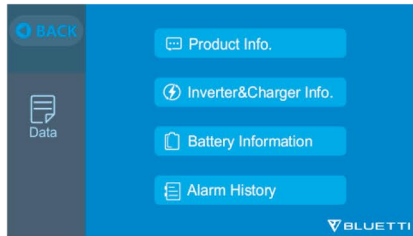

- **Product Info**

This section includes the information about product model, serial number (SN), control firmware (DSP), monitoring firmware (ARM), display firmware (HMI) and BMS. The serial number (SN) can also be used to bind the unit to BLUETTI APP manually.

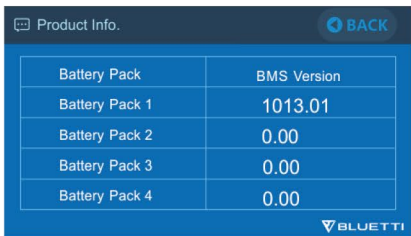

- **Inverter & Charger Info**

This section displays the input and output status of the unit. These information is also displayed on the homepage.

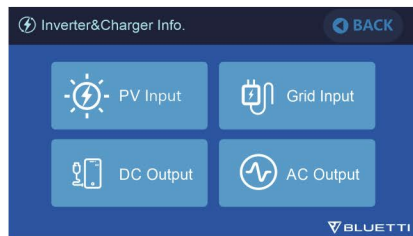

- **Battery Information**

This section is about the connection and operation status of battery pack(s), which can also be accessed directly from the homepage.

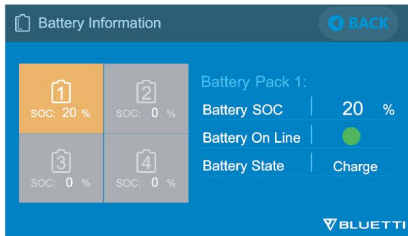

- **Alarm History**

This section records all alarms generated which can be manually deleted.

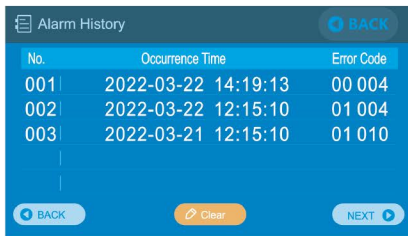

### 4.3 Charging

AC300+B300 supports AC charging (wall outlet, generator), DC charging (solar, AC adapter, car, lead-acid battery), and DUAL charging through AC Charging Port[CPI] and DC Charging Port [CP2].

### 4.3.1. AC Input (1st Charging Port: CPI)

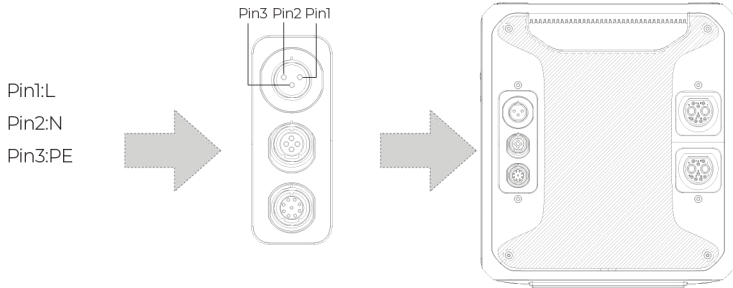

- **Charging Method 1: AC charging**

Connect the AC300+B300 to a wall outlet via the AC charging cable. The charging automatically stops when the AC300 system reaches 100% capacity.

The maximum charging power allowed is up to 3000W.

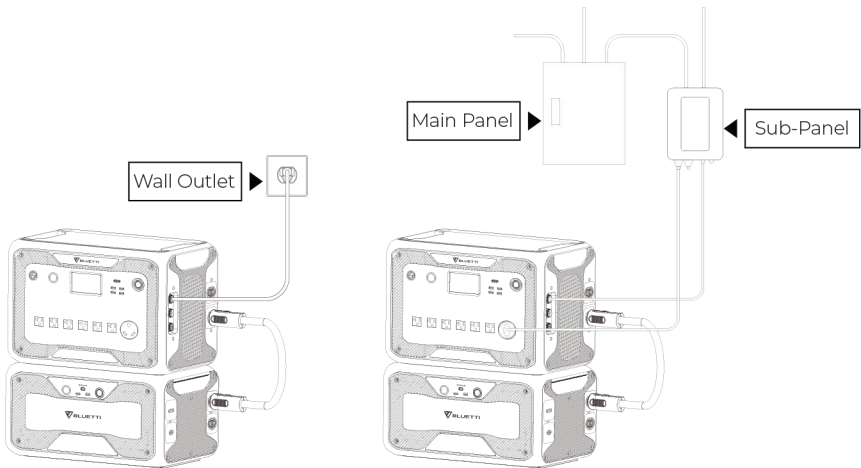

- **Charging Method 2: Generator Charging(Gasoline/Propane/Diesel)**

Connect the AC300+B300 to a generator via the generator charging cable.

The charging automatically stops when the AC300 system reaches 100% capacity.

**Note:** It is recommended to use a generator with pure sine wave output, such as inverter generator.

Please make sure your generator meets the following:

Voltage: 120VAC

Frequency: 50Hz/60Hz\*

\*If the AC input frequency of AC300 is set to 50 Hz, use a generator with a frequency of 47Hz-53Hz; if it is set to 60Hz, the generator frequency should be 57Hz-63Hz.

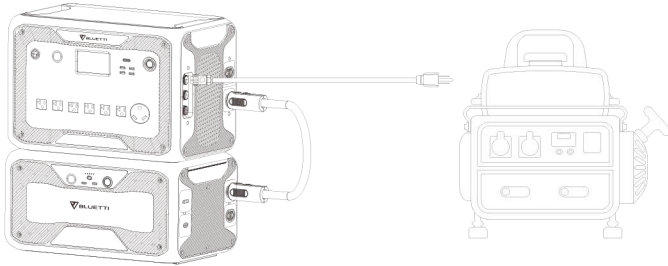

### 4.3.2. DC Input (2nd Charging Port: CP2)

- Pin1: DC1 PV+
- Pin2: DC2 PV+
- Pin3: DC1 PV-
- Pin4: DC2 PV-

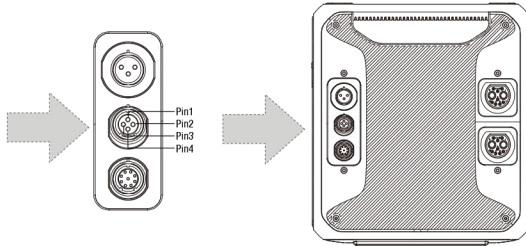

#### • Charging Method 3: Solar Charging (via 4pin aviation-MC4 cable)

How to connect AC300 to a regular solar panel:

AC300+B300 supports dual PV input, DC1+DC2. Please make sure your solar panels at each input comply with: Voc: 12V-150VDC Current: 12A Max.

Power: 1200W Max.

Steps for solar charging:

- a. Set PV as the DC Input Source.
- b. Set PV Parallel Enable to OFF.
- c. Connect solar panels in series(Figure 1).
- d. Connect the solar panels to AC300 via the DC charging cable (Figure 2, 3,4).

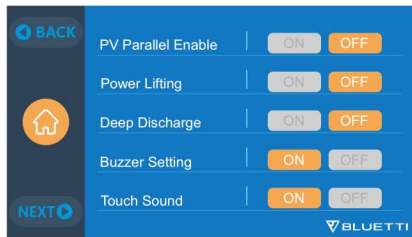
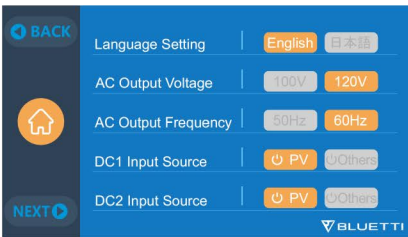
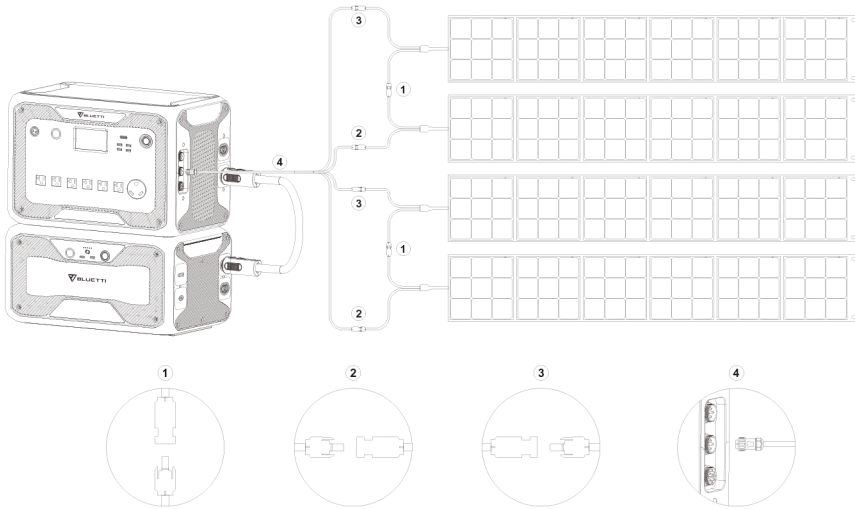

How to connect AC300 to rooftop solar panels:

Note: Roof/Rigid panel can charge AC300. If the panel's open circuit voltage falls in 150V-550VDC, use D300S to lower the voltage.

i)  $150V < V_{oc}$  of PV  $< 550V$ :

Connect to D300S

DC Input Source: Others

PV Parallel Enable: OFF

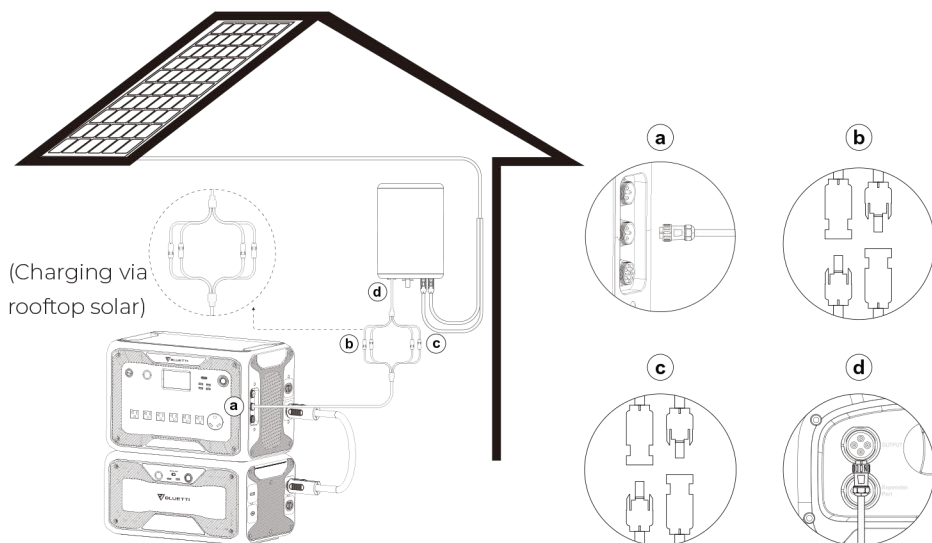

a. DC output cable to AC300

c. DC2 plug to PV2

b. DC1 plug to PV1

d. DC output cable to D300S

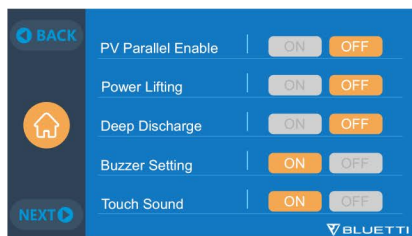

ii)  $V_{oc}$  of PV  $< 150V$  & solar system  $> 1200W$ :

DC Input Source: PV

PV Parallel Enable: ON

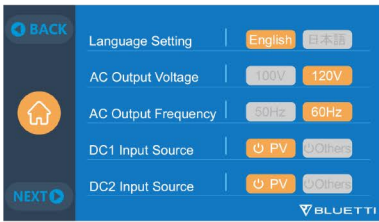

#### • Charging Method 4: Car Charging

Connect the AC300+B300 to the vehicle plug-in cigarette lighter port via the DC input cable and car charging cable.

**Note:** Set Others as DC1/DC2 input source to enable car charging.

The maximum input current is 8.2A.

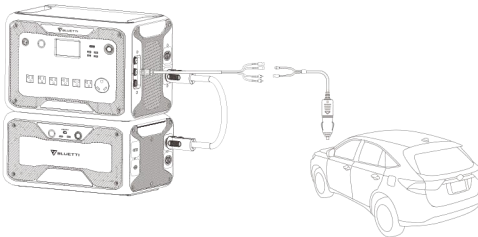

#### • Charging Method 5: Charging via a 12V/24V Lead-acid battery

Connect the AC300+B300 to the lead-acid battery via the DC input cable and lead-acid battery charging cable. Clamp the positive connector(red) to the positive battery terminal and negative(black) to the other.

**Note:** Set Others as DC1/DC2 input source to enable lead-acid battery charging.

The maximum input current is 8.2A.

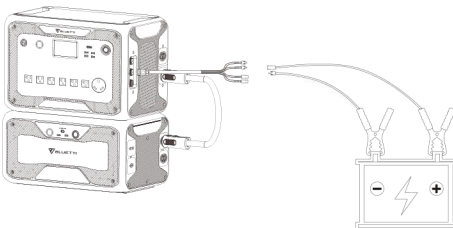





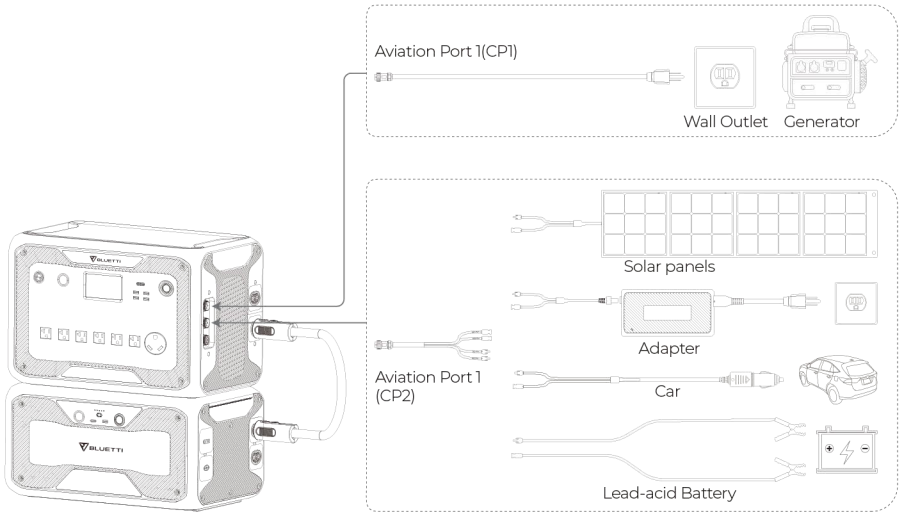



### 4.3.3. Dual Charging

AC300+B300 also support dual charging via AC input and DC1/DC2 input ports simultaneously.



### 4.4 Discharging

 <p>Fridge 2.8 Days 700W(24h)</p>	 <p>Microwave Oven 5hrs 1000W</p>	 <p>Washing Machine 4.8-9.2hrs 500/1000W</p>	 <p>Space Heater 3.2hrs 1500W</p>
 <p>Air Conditioner 2hrs 8000Btu</p>	 <p>Smartphone 115 Times 18Wh</p>	 <p>Laptop 71 Times 45Wh</p>	 <p>Electric Vehicle(16A) 13.5-16 Miles 1800W</p>

$6144Wh^* \times DoD \times \eta \div (\text{load power}) = \text{charging time (estimated)}$

\* Take the AC300+2\*B300 combo as an example.

**Note:** DoD refers to the Depth of Discharge,  $\eta$  is the local inverter efficiency. DoD=90%,  $\eta$ =90%.

DoD may vary depending on ambient-operating temperature and discharge rate.

Load power and charging time are measured in Watt and Hour.



## 4.5 Capacity Expansion

Connect the AC300 power station with B300 via the P090D battery expansion cable.

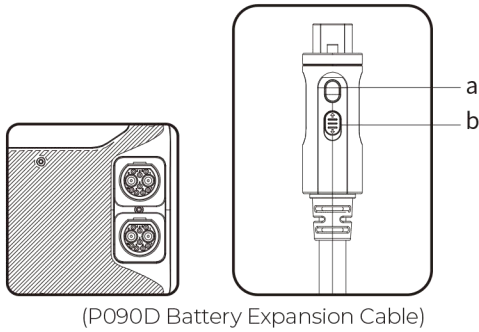

- a: Press and pull to disconnect the unlocked cable.
- b: Lock/unlock the connection.

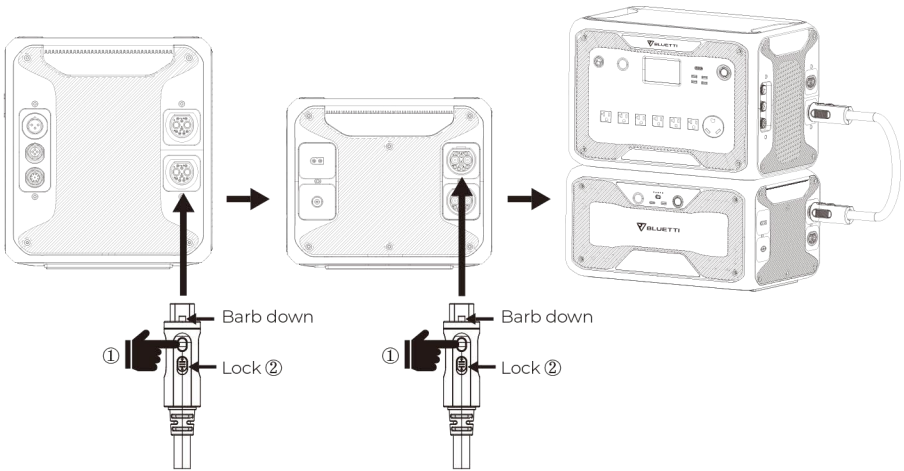

**Note:** Press either the power button on AC300 or B300 to turn on the AC300 + B300 combo.

When AC300 is connected to power source, the AC300 + B300 combo turns on automatically.

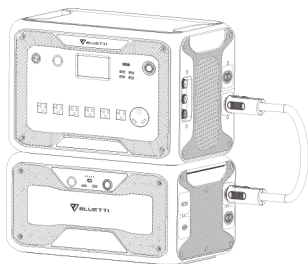

AC300 + 1\*B300 = 4500W Max. / 3072Wh

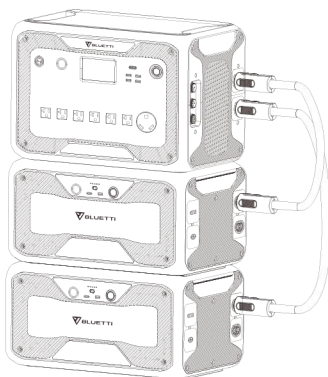

AC300 + 2\*B300 = 5000W Max. / 6144Wh

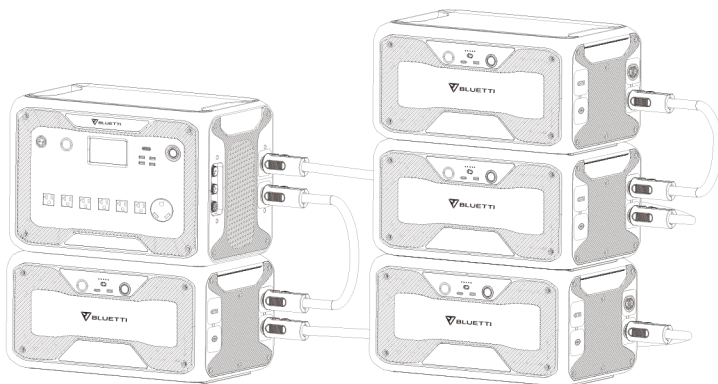

AC300 + 4\*B300 = 12288Wh

### B300 Capacity Expansion Examples

## 4.6 UPS

### 4.6.1. UPS Description

An uninterruptible power supply or uninterruptible power source (UPS) is an electrical apparatus that provides emergency power to a load when the input power source or mains power fails. A UPS differs from an auxiliary or emergency power system or standby generator in that it will provide near-instantaneous protection from input power interruptions, by supplying the energy stored in backup batteries.

**Note:** Do not apply this unit to equipment that has high performance requirements for UPS, including data servers, workstations, medical devices, etc. Please perform multiple tests to confirm compatibility before connecting devices.

BLUETTI shall not be liable for any loss of data, equipment damage or human injury caused by customers' failure in following the instruction.

#### • Connection

Tie the AC300 to the grid with sub panel or plug it into the wall outlet with AC charging cable. Then connect loads to the AC output ports of AC300.

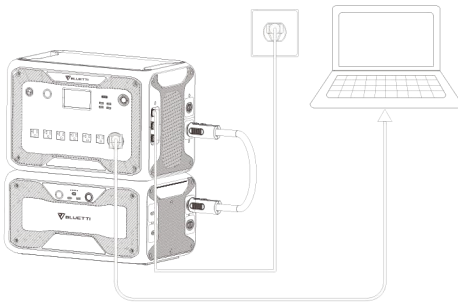

(Plug-in UPS)

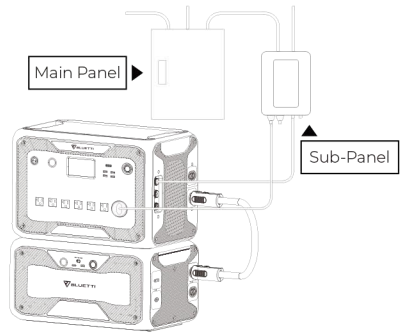

(Grid-tied UPS)

**Note:** Refer to "How to build a partial-home backup system with AC300+B300 for more details about Grid-tied UPS.

**Note:** The output power in Plug-in UPS Mode is subject to the specification of the current and voltage from home circuit.

E.g.: Current (10A wire) x Voltage (120V) = 1200W in US

- **Activation**

On the homepage, tap Settings and then tap Next and Working Mode to select the UPS Mode. The working mode is set at Standard UPS by default.

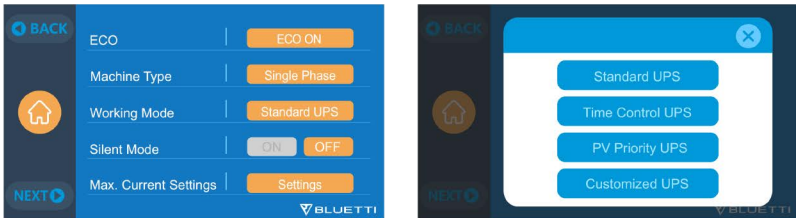

## 4.6.2. UPS Working Modes

- **Standard UPS Mode**

AC300+B300 plays as a backup power source when the grid presents, immediately charging your loads when the grid fails. This mode is suitable for regions with unstable grid power supply.

Tap YES to enable Standard UPS Mode:

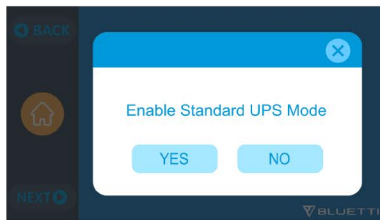

Standard UPS page:

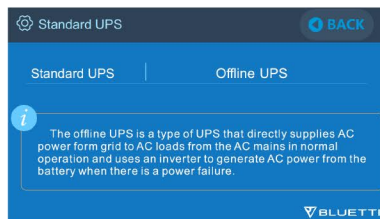

The combo is set at Standard UPS by default. The grid first charges the combo, and then powers the devices at the AC output ports. When the grid fails, the combo automatically steps in and powers the devices.

Online UPS supplies power from the grid to the load through a rectifier and inverter combination regardless there is grid power or a power outage.

Offline UPS supplies power from the grid directly to the load when grid power is available, and whenever there is a power outage, it provides power to the load through the backup battery.

• **Time Control UPS Mode**

AC300+B300 charges and discharges at specific time periods, greatly cutting your electricity bills. Recommended charging and discharging time:

Charge Time: Charge the system during off-peak hours to save money.

Discharge Time: Use AC300+B300 to power your loads when electricity prices are high.

Tap YES to enable Time Control UPS Mode:

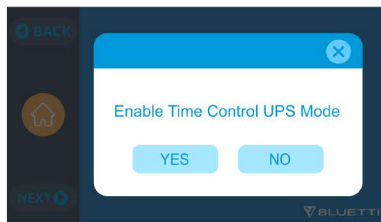

Time Control UPS page.

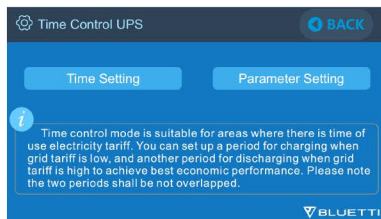

Time Setting: Tap to specify a period for charging when grid tariff is low, and another period for discharging when grid tariff is high to save money.

Parameter Setting: Tap to specify when to cut off power output and when to stop charging by grid.

Tap Time Setting on Time Control UPS page to open Time Setting page:

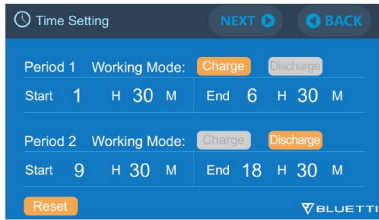

**Note:** Please check if the system date and time is correct before setting this.  
These two periods shall not be overlapped.

- **Period 1/2 Working Mode:**

Tap Charge/Discharge to set the time period to be the charging/discharging period.

Tap Parameter Setting on Time Control UPS page to open Parameter Setting page:

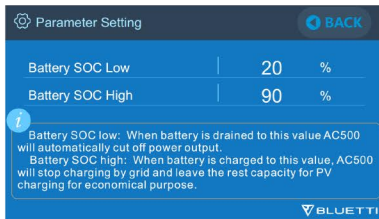

**Battery SOC Low:** When the remaining battery capacity is lower than preset charge value, the load will be powered by the grid in bypass mode. Setting it at 0 may cause the failure of bypass function.

**Battery SOC High:** When reaching the preset charge value, AC300 will be recharged via PV instead of the grid.

- **PV Priority UPS Mode**

The PV Priority UPS mode is better for regions with plenty of sunlight all the year.

AC300+B300 is mainly charged by solar energy to save power.

**Note:** When battery SOC is higher than set value, devices on AC outlets are powered by grid and the combo together.

When battery SOC is lower than set value, the grid charges the combo and devices at the same time.

Tap YES to enable PV Priority UPS Mode:

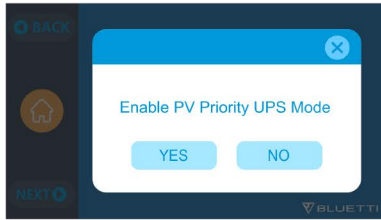

PV Priority UPS page:

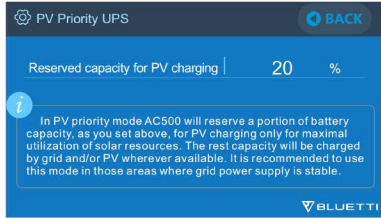

Reserved capacity for PV charging: Specify the portion of battery capacity for PV charging only. AC300+B300 charges to this SOC from the grid, then from solar panels or other sources.

- **Customized UPS Mode**

AC300+B300 operates based on your energy plan, charging and discharging on schedule, prioritizing solar charging, and more. In this mode, you can also maximize solar energy, or even live completely off the grid by disabling grid charging.

Tap YES to enable Customized UPS Mode:

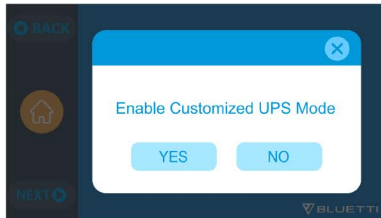

“Customized UPS” page:

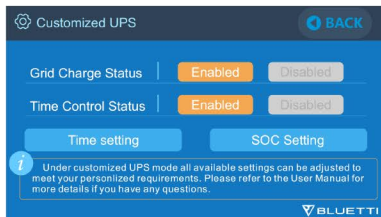

Grid Charge Status: By enabling this, the combo can be charged from the grid and keep the grid settings.

Time Control Status: By enabling this, the combo can keep the settings of charging and discharging time.

Time Setting: Tap to specify the charging and discharging periods for your AC300.

SOC Setting: Tap to specify when to cut off power output and when to stop charging by grid.

**Note:** The Time Setting and SOC Setting also take effect in Time Control UPS and PV Priority UPS modes.

Tap Time Setting on the Customized UPS page:



**Note:** Please check if the system date and time is correct before setting this.

These two periods shall not be overlapped.

Period 1/2 Working Mode:

Tap Charge/Discharge to set the time period to be the charging/discharging period.

SOC Setting on the Customized UPS page:

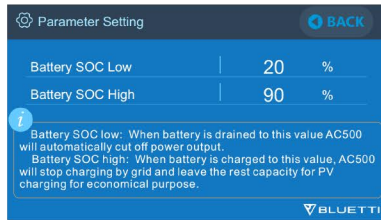

Battery SOC Low: When the remaining battery capacity is lower than preset charge value, the load will be powered by the grid in bypass mode. Setting it at 0 may cause the failure of bypass function.

Battery SOC High: When reaching the preset charge value, AC300 will be recharged via PV instead of the grid.



## 4.7 BLUETTI APP

Download the BLUETTI App from App Store or Google Play.



### 4.7.1. WiFi Connection

(1) Tap Login and Sign up to register BLUETTI account.

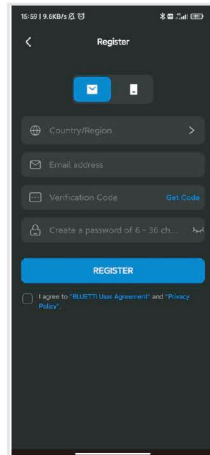
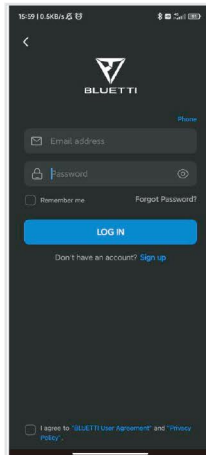
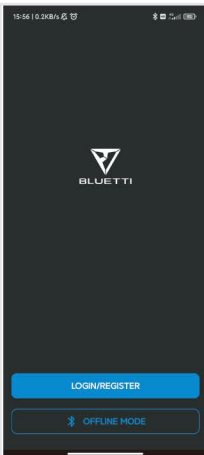

<sup>5</sup> Includes heaters, irons or any other devices consisting of heating elements only.

(2) Scan the QR code on the unit and set the WiFi network.

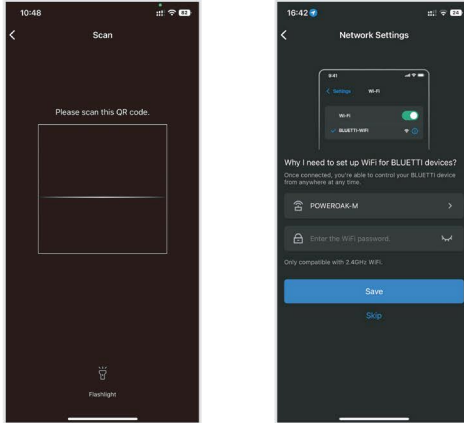

**Note:** The unit supports 2.4GHz WiFi ONLY.

Find the SN(Serial Number) on the unit or from the 'Product Info.'

If the WiFi connection fails, go to Settings(on your phone), tap BLUETTI and allow the network.

#### 4.7.2. Bluetooth Connection

Tap 'OFFLINE MODE' and pair with the unit.

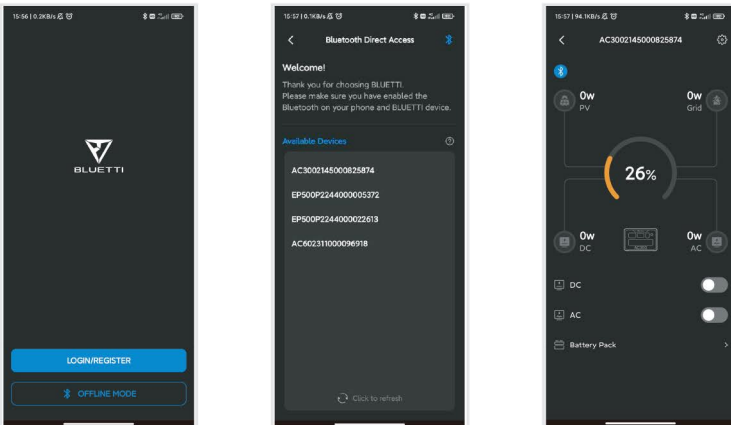

**Note:** For better IOT experience, please register the unit with WiFi.

Keep your phone no more than 16.4ft/5m away from the unit during the upgrade.

### 4.7.3. Customizing Settings

Tap '⚙️' to customize the settings.

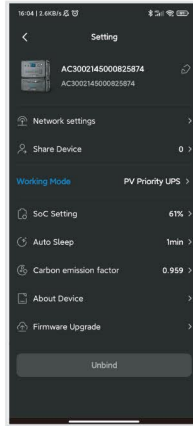
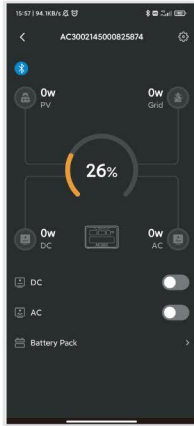

Tap Working Mode to choose UPS mode. Refer to UPS section in this manual for more details.

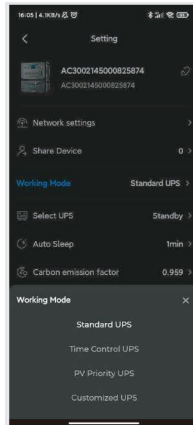
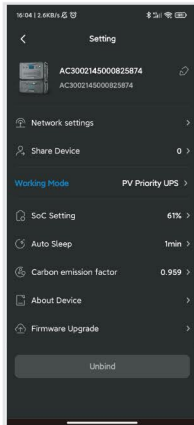

The unit supports over-the-air(OTA) firmware upgrade. Tap Firmware Upgrade to upgrade the software systems.

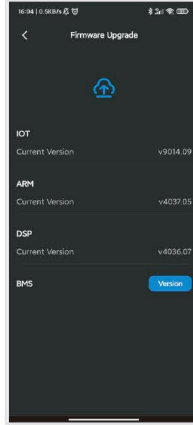
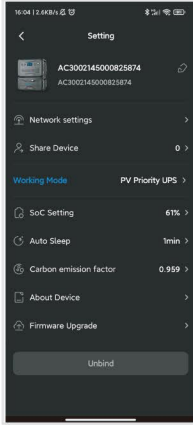

#### 4.7.4. BMS Details

Tap Battery Pack to check out the Battery Management System (BMS) details.

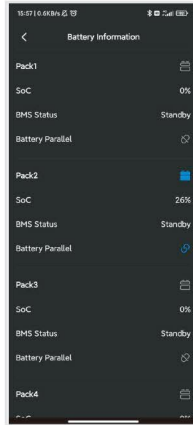
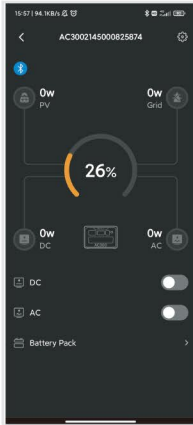

## 4.8. Split Phase System

Connect two AC300 combos together with the following accessories:

- Transfer switch: Reliance 310A Pro/Tran 2
- AC300 split-phase output cable
- NEMA 14-30R socket
- AC300 split-phase AC charging cable
- Communication cable

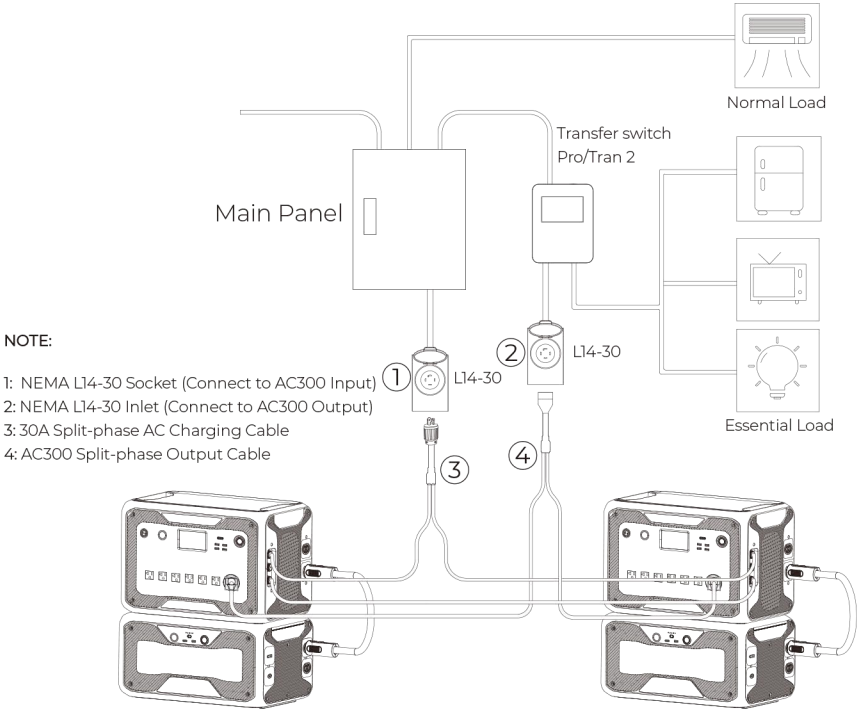

Go to 'Advanced Setting', tap 'Next' and set both AC300 to 'split phase'.

Choose one to be the 'Master' unit, the other 'Slave'.

If the connection fails, clear the alarm history and reconnect.

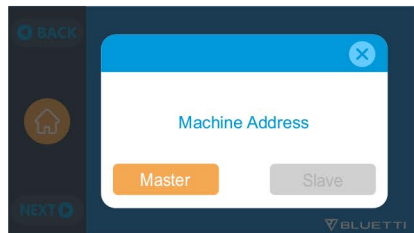
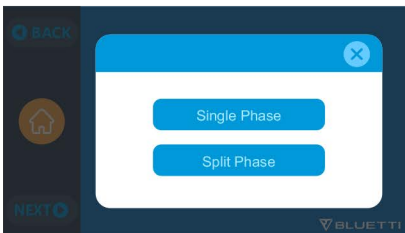

**Note:** The system can be turned on/off ONLY on the 'Master' unit.

## 5. Appendix

### 5.1 FAQs (Frequently Asked Questions)

**Q: Can I use third-party solar panels to charge this product?**

A: Yes, you can. As long as the specs of solar panels on DC1/DC2 fall in below range:

OCV&Vmp: 12V~150V

Input Power: 1200W Max.

With the same power connector (MC4)

DO NOT mix different types of solar panels.

**Q: Why can't the unit be charged when the solar panels are connected?**

A: Please perform the following steps:

- 1) Touch the 'PV' on LCD screen to check whether the solar panels are connected successfully.
- 2) Check the connection of solar panels and the PV input cable.

If the symptom persists, please contact BLUETTI service team.

**Q: How to choose the right UPS mode for my home?**

A: The standard UPS mode is good for regions with unstable grid power supply;

The Time Control UPS mode saves your electricity bills by setting the charging and discharging time.

The PV Priority UPS mode is better for regions with plenty of sunlight all the year.

The Customized UPS mode allows you to design your own power supply system.

**Q: How long will it take to switch the UPS?**

A: 20ms.

**Q: How to upgrade the firmware?**

A: Connect the unit with BLUETTI App, then you can over-the-air (OTA) upgrade the firmware including ARM, DSP, HMI, and BMS.

## 5.2 FCC Warning

This device complies with part 15 of the FCC Rules.

Operation is subject to the following two conditions:

- 1) This device may not cause harmful interference
- 2) This device must accept any interference received, including interference that may cause undesired operation.

This equipment has been tested and found to comply with the limits for a Class B digital device, pursuant to part 15 of the FCC Rules. These limits are designed to provide reasonable protection against harmful interference in a residential installation. This equipment generates, uses and can radiate radio frequency energy and, if not installed and used in accordance with the instructions, may cause harmful interference to radio communications. However, there is no guarantee that interference will not occur in a particular installation.

If this equipment does cause harmful interference to radio or television reception, which can be determined by turning the equipment off and on, the user is encouraged to try to correct the interference by one or more of the following measures:

- 1) Reorient or relocate the receiving antenna.
- 2) Increase the separation between the equipment and receiver.
- 3) Connect the equipment into an outlet on a circuit different from that to which the receiver is connected.
- 4) Consult the dealer or an experienced radio/TV technician for help.

### FCC RF Radiation Exposure Statement

This equipment complies with FCC radiation exposure limits set forth for an uncontrolled environment. This equipment should be installed and operated with minimum distance 20cm between the radiator and your body. This transmitter must not be co-located or operating in conjunction with any other antenna or transmitter.

**FCC Caution:** Any changes or modifications not expressly approved by the party responsible for compliance could void the user's authority to operate this equipment.

### 5.3 Technical Support

Should you require any further assistance, please do not hesitate to contact BLUETTI service team.



## For more information, please visit:

Web: <https://www.bluettipower.com>



@ BLUETTI Support

@ BLUETTI Official



@ bluetti\_inc



@bluetti.inc



@bluetti\_official



service@bluettipower.com

### SHENZHEN POWEROAK NEWENER CO., LTD.

Add: F19, BLD No.1, Kaidaer, Tongsha Rd No.168, Xili Street,  
Nanshan, Shenzhen, China

### USA Agent

Company name: BLUETTI POWEROAK INC

Address: 6185 S VALLEY VIEW BLVD STE D LAS VEGAS

NEVADA 89118 United States

FRN: 0033559824

Contact Name: Qiyao Li

Telephone No: +1-512-966-1898 1

Email: liqy@bluetti.com

### Customer Service

Tel: 800-200-2980 (Monday to Sunday, 9:00-17:00)

Mail: sale@bluettipower.com (Pre-sales), service@bluettipower.com (After-sales)







**BLUETTI**



Just Power On