

# B80

# Portable Power Station

## User Manual

Please Read This Manual Before Use And Follow Its Guidance.  
Keep This Manual For Future Reference.



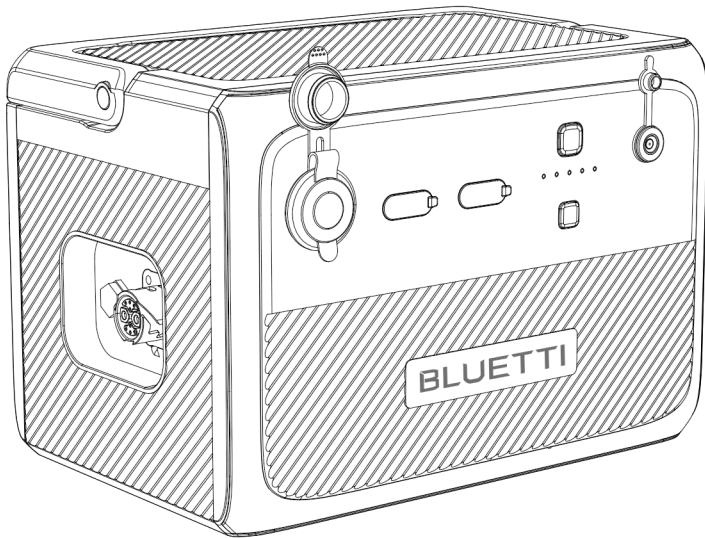

 **Warning**

1. Charge the unit before first use.
2. Do not use solar panels with open circuit voltage higher than 28V. Solar input voltage range for the unit is DC 12V~28V.
3. Charge the unit when the SoC drops below 5%. If the SoC drops to 0, power off the unit and charge it for at least 30mins before restarting.
4. The unit is for off-grid use only. Do not connect its AC output to the grid.
5. If not used for more than 3 months, charge the unit to 40%~60% SoC and store it with the power off. For optimum battery life, discharge and charge the unit every 3 months.

# Thank You!

Thank you for making BLUETTI a part of your family.

From the very beginning, BLUETTI has tried to stay true to a sustainable future through green energy storage solutions for both indoor and outdoor use while delivering an exceptional eco-friendly experience for our homes and our world. That's why BLUETTI makes its presence in 70+ countries and is trusted by millions of customers across the globe.



# Contents

1	Safety Instructions .....	05
1.1	General Safety .....	05
1.2	Handling .....	07
1.3	Storage and Usage .....	07
2	What's In The Box .....	08
3	Product Overview .....	10
3.1	Diagram .....	10
3.2	Specifications .....	11
4	Operating Instructions .....	12
4.1	Buttons .....	12
4.2	Power indicator .....	12
4.3	Charging .....	12
4.4	Discharging .....	14
5	Appendix .....	16
5.1	FAQs .....	16
5.2	Abbreviations .....	16
5.3	FCC Warning .....	17
5.4	Important Instructions .....	19

# 1. Safety Instructions

Read this manual for instructions on the proper use and safety information for the unit. Follow the warnings and instructions marked on the unit and its accessories.

Pay attention to the "Instruction", "Caution", "Warning" and "Danger" symbols in this manual, and follow the instructions carefully to avoid injury or damage.

The Safety Requirements provided herein are for illustrative purposes that include but are not limited to those listed in this manual. Actual operation shall comply with all applicable safety standards.

If you have any questions, feel free to contact BLUETTI support or your local BLUETTI dealers.

## 1.1. General Safety

- Always operate or store the unit in the conditions specified in this manual.
- The installation and ambient conditions must comply with the regulations in the relevant international, national or regional standards.
- Unauthorized disassembly, alteration of the equipment or modification of the software code is not allowed.

### **BLUETTI shall not be liable for the following circumstances:**

- Equipment damage caused by force majeure, such as earthquake, fire, storm, flood, mudslide, etc.
- Damage or loss during transportation.
- Damage caused by storage conditions that do not meet the requirements specified in this manual.
- Damage to the hardware or data of the equipment due to customer negligence, improper operation or intentional damage.
- Damage to the system caused by a third party or the customer, including handling and installation that does not meet the requirements specified in this manual.
- This product is not suitable for providing electrical service for equipment and machines that are highly dependent on the reliability of electrical power supply and that involve personal safety, such as atomic energy, aviation, medical, etc. Poweroak will not be held responsible for any personal safety accidents, fire accidents, equipment failures, etc. caused by using this product to supply power to the above equipment and machines.
- Damage caused by adjustment, alteration or removal of identification marks.

### **To avoid danger, please regulate the operation in the following manner:**

- Do not install, use and maintain the unit in adverse weather conditions such as lightning, rain, snow and strong breezes (including but not limited to handling and operating the unit, plugging and unplugging signal connections to outdoor facilities, working at height, outdoor installations, etc.).

- Always turn off the power source before starting any electrical work.
- Do not clean the unit with water.
- Do not disassemble, modify, tamper with or repair the unit on your own.
- Regularly inspect the unit and its accessories for damage or deterioration.
- Use a tester to check for the presence of dangerous voltage before touching any conductor or terminal.
- If the unit's shell is cracked during transportation or use, do not use it and contact BLUETTI support or your local BLUETTI dealers.
- Use a dry powder extinguisher if the unit catches fire.
- In case of fire, EVACUATE the building or affected area immediately, activate the closest FIRE ALARM system and CALL 9-1-1 or your local emergency phone number.
- Use genuine cables and accessories provided by BLUETTI.
- Keep the unit away from heat sources or high temperatures, and do not expose it to direct sunlight.
- Do not store the unit with flammable liquids, gases, or explosive materials.
- Make sure the area where you are using the unit is well ventilated and spacious.
- Do not block or cover the vents of the unit as this may cause irreversible damage to it.
- Use the unit for its intended purpose and avoid stacking objects on top of it during storage or use.
- Do not move the unit during operation as the vibrations and shocks associated with movement may cause damage to the internal hardware.
- In case of malfunction, turn off the unit immediately and contact BLUETTI support or your local BLUETTI dealers if this manual cannot adequately explain the malfunction to you.
- Do not place the unit on an unstable or inclined surface.
- Do not insert foreign objects into any port and vent of the unit.
- Keep away from children and pets.

## Legal and Regulatory Requirements

- The transportation, wiring and maintenance shall comply with all applicable laws, regulations and standards.
- User-provided materials and tools required shall meet the requirements specified in applicable laws, regulations and relevant standards.

## 1.2.Handling

Use mechanical assistance as needed (e.g. trolleys and adjustable height workbenches).

### Recommended number of people based on the weight of product

Weight	Number of people
<18kg	1
18kg~32kg	2
32kg~55kg	3
>55kg	4 or a cart

## 1.3. Storage and usage

- When not using the unit for over 3 months, charge it to 40% to 60% SoC to keep it in optimal condition.
- Before storing the unit, power it off and remove all electrical connections from it.
- Store the unit in a cool and dry place. The ideal temperature range is 10°C to 30°C. The unit can be safely charged and discharged at temperatures of -20°C to 40°C. However, it's NOT recommended to store the unit in harsh temperatures for extended periods of time.
- Fully cycle the unit every 6 months to maintain the battery's health.

If the SoC drops to 0 (during operation or upon startup), take the following actions to safely restart the unit:





- 1) Shut down immediately.
- 2) Charging within 48 hours.
- 3) Battery should be kept at an ambient temperature of 5°C to 35°C for 24 hours before charging.

It is recommended to charge the unit via an AC source. If charging via solar energy, ensure that your solar system provides an output of more than 100W.

BLUETTI shall not be liable for any equipment damage caused by the violation of above instructions.

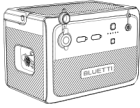
## 2. What's In The Box





### Standard Packaging

Item	Picture	Qty.
Expansion Battery		1
Battery Expansion Cable (800mm)		1
User Manual		1
Warranty Card		1
Quality Certificate		1

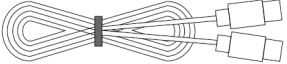
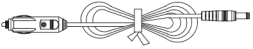
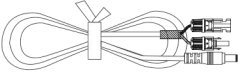

## Optional

(Available on official BLUETTI website)

Item	Picture
TYPE-C Cable (5A/100W, 2m)	
Car Charging Cable (16AWG, 720mm)	
Solar Charging Cable (16AWG, 1500mm)	
Extended Battery Expansion Cable (1830mm)	
Power Bank Output Cable (14AWG, 720mm)	
200W Charger	

## 3. Product Overview

### 3.1 Diagram

The BLUETTI B80 can be used with AC60 as an external expansion battery, or as a DC power station to run your devices independently. It offers up to 120W output with 3 DC ports - USB-A, USB-C and car cigarette lighter port, perfect for your phone, laptop, car fridge, and more. While LiFePO<sub>4</sub> battery cells and an advanced battery management system (BMS) protect your device from a variety of potential risks during daily operation. When connected to AC60, it adds extra 806Wh capacity to the whole power system for longer device runtime.

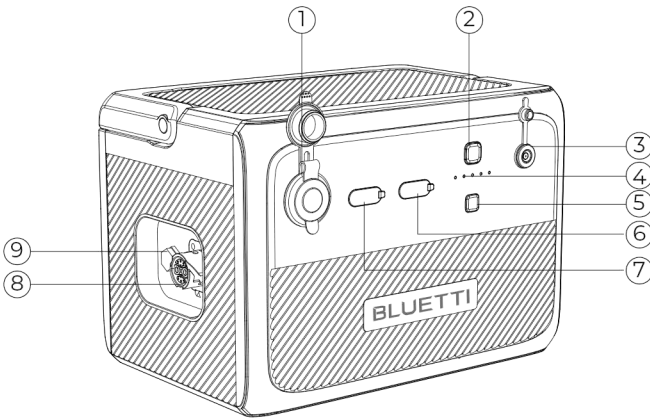

- ① Cigarette Lighter Port
- ② Power Button
- ③ DC Input
- ④ Power Indicator
- ⑤ DC Power Button
- ⑥ USB-A Port
- ⑦ USB-C Port
- ⑧ Battery Expansion Port
- ⑨ Bleed Valve

### 3.2 Specifications

Model	B80
<b>General</b>	
Battery Capacity	806Wh
Cell Type	LiFePO4
Charging Temperature	0°C~40°C/32°F~104°F
Discharging Temperature	-20°C~40°C/-4°F~104°F
Storage Temperature	-20°C~40°C/-4°F~104°F
Working Humidity	10%~90%
Weight	About 9.9kg/21.83lbs
Dimensions (L*W*H)	290mm×207mm×204mm/11.42in×8.15in×8.03in
<b>DC Output</b>	
Cigarette Lighter Port	12VDC/10A
USB-A	5VDC/3A; 9VDC/2A; 12VDC/1.5A
USB-C (Type-C)	5/9/12/15/20VDC, 3A; 20VDC, 5A (Built-in eMarker chip)
<b>DC Input</b>	
Interface	DC7909
Power	200W/8A MAX.
Voltage	12V~28VDC
<b>Expansion Port</b>	
Rated voltage	22.4VDC
Max. Input Current	30A
Power Bank Output	25.2VDC, 200W Max.

## 4. Operating Instructions

**DANGER:** This device is intended to be used indoors only. Do not use outdoors.

### 4.1 Buttons

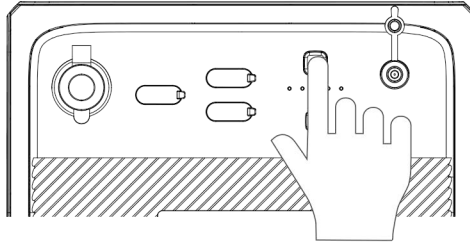

B80 has a power button and a DC output button.

- Press the power button to start up B80. Press and hold for more than 2 seconds to turn it off.
- Press the DC power button to turn on/off the DC output (cigarette lighter and USB output).

### 4.2. Power indicator

BLUETTI B80 has 5 LED indicators. From left to right, they represent 20%, 40%, 60%, 80%, 100% SoC, respectively.

### 4.3 Charging

B80 supports 4 charging methods: AC60 charging, solar, car (cigarette lighter) and adapter.

#### 4.3.1. AC60 Charging

Connect the AC60 and B80 and plug the AC60 into a wall outlet via the AC charging cable. The AC60 will automatically charge the B80.

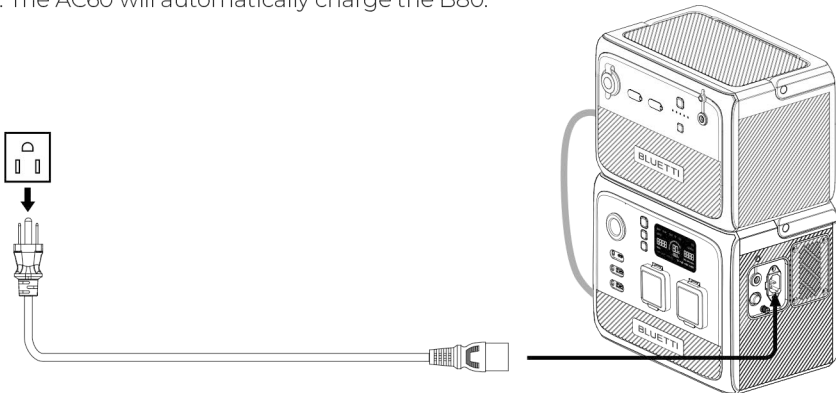

### 4.3.2. Solar Charging

Connect the solar panels (in series or parallel) to B80 via the solar charging cable.

**Note:** Please make sure your solar panels comply with:

Voc: 12V-28VDC    Input Current: 8A Max.    Input Power: 200W Max.

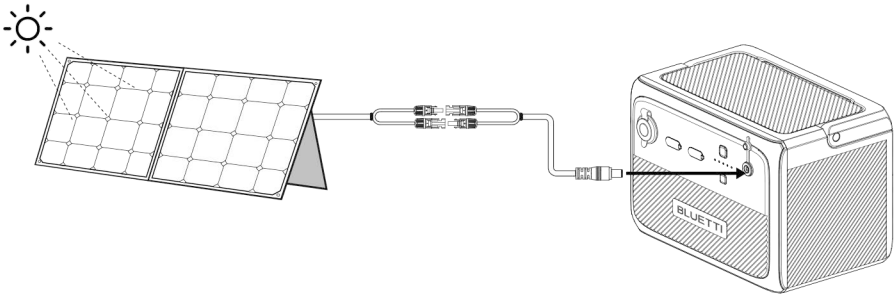

**Warning:** The open circuit voltage of solar panels cannot exceed 28V, otherwise it will damage the device. (Note: This is not covered in the warranty.)

### 4.3.3. Car Charging

Connect the B80 to vehicle's 12V cigarette lighter port via the car charging cable.

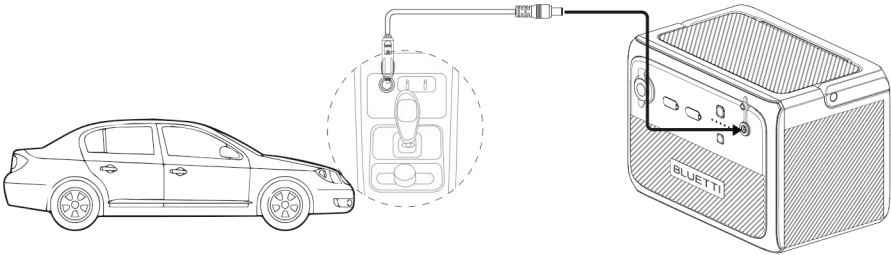

**Warning:** Cigarette lighter must be completely plugged in, otherwise it may cause safety risks.

### 4.3.4. Adapter Charging

The B80 can be charged via adapter. Please make sure the output voltage of adapter is between 12V~28VDC.

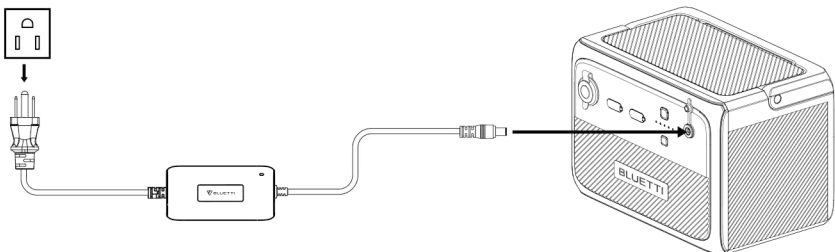

## 4.4 Discharging

### 4.4.1. DC Output

The operation time of B80 is subject to many factors, such as ambient temperature, discharge rate, battery capacity, altitude, load characteristics, etc.

- 12V/10A cigarette lighter
- USB-C (5/9/12/15/20VDC, 3A; 20VDC, 5A)
- USB-A (5V/3A; 9V/2A; 12V/1.5A)
- Expansion Port (17.5V-25.2VDC, 30A Max.)

### 4.4.2. Connect to AC60

With the battery expansion cable, AC60 supports up to 2 B80 expansion batteries for a total capacity of 2015Wh. Turn on AC60 to activate the whole power system.

**Note:** Make sure the AC60 and B80 are off when connecting and disconnecting cables.

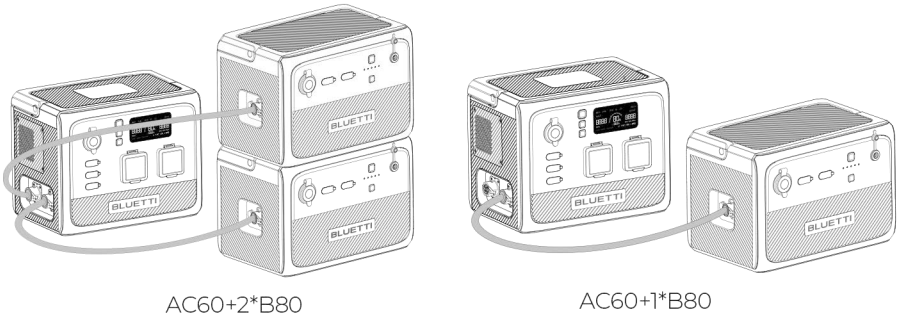

### 4.4.3. Power Bank Mode

Connect the B80 to a compatible power station via the power bank output cable, press and hold its power button for about 5s, and it can recharge the power station directly.

**Note:**

In Power Bank mode, the B80 delivers a voltage of up to 25VDC. Please check the DC input voltage of your BLUETTI power station for compatibility.



#### 4.4.4. Estimated Operation Time

Operation time (estimated) = Battery capacity (Wh) × DoD ×  $\eta$  ÷ (load power)

**Note:**

1) Load power and operation time are measured in watts and hours.

2) DoD refers to depth of discharge. B80 works at 90% DoD for longer battery life.  $\eta$  is the conversion efficiency of the inverter, which is 90% for B80.

E.g. If you run a 40W refrigerator with B80, the operation time will be:

$$806\text{Wh} \times 90\% \times 90\% \div 40\text{W} \approx 16 \text{ hrs}$$

**Note:** Low temperature and excessive loads could greatly impact the battery capacity and reduces its normal operation time.

## 5. Appendix

### 5.1 FAQs

**Q1:** How do I know whether my devices will work well with this product?

**A:** Please evaluate the total constant load of your devices. If it doesn't exceed the Max. output power of B80 (120W), you can use this power station to run your devices.

**Note:** Some devices with built-in motor/compressor may start at 2-4 times the rated power, which can easily overload the B80.

**Q2:** Can I use third-party solar panels to charge this product?

**A:** Yes, you can. Make sure your solar panels have an open circuit voltage of 12V-28V and have the MC4 connectors. Please do NOT mix different types of solar panels.

**Note:** Time required for one full charge depends on weather condition, the sunshine intensity and the angle of solar panels.

**Q3:** Can it charge and discharge at the same time?

**A:** Yes. It supports pass-through charging. B80 comes with the premium LiFePO4 battery and proprietary Battery Management System to ensure that it can charge and discharge at the same time.

**Q4:** Why does the B80 shut down automatically?

**A:** Two scenarios in which B80 shuts down itself:

If DC output is not turned on after power on, it will automatically shut down after 4 hours.

If DC output is less than 10W, it will automatically shut down after 24 hours.

**Q5:** Why is the charging power often too low?

**A:** B80 has a built-in intelligent BMS that automatically adjusts the charging power in response to the battery temperature and SoC, thus protecting the battery and extending its service life.

### 5.2 Abbreviations

- MPPT: Maximum Power Point Tracking
- SoC: State of Charge
- AC: Alternating Current
- DC: Direct Current
- PV: Photovoltaic (Solar Panels)
- DoD: Depth of Discharge
- ECO mode: It's an energy-saving mode(It's on by default). It can not be turned off. If DC output is not turned on after power on, it will automatically power down after 4 hours.



## 5.3 FCC Warning

This device complies with part 15 of the FCC Rules.

Operation is subject to the following two conditions:

- 1) This device may not cause harmful interference
- 2) This device must accept any interference received, including interference that may cause undesired operation.

This equipment has been tested and found to comply with the limits for a Class B digital device, pursuant to part 15 of the FCC Rules. These limits are designed to provide reasonable protection against harmful interference in a residential installation. This equipment generates, uses and can radiate radio frequency energy and, if not installed and used in accordance with the instructions, may cause harmful interference to radio communications. However, there is no guarantee that interference will not occur in a particular installation.

If this equipment does cause harmful interference to radio or television reception, which can be determined by turning the equipment off and on, the user is encouraged to try to correct the interference by one or more of the following measures:

- 1) Reorient or relocate the receiving antenna.
- 2) Increase the separation between the equipment and receiver.
- 3) Connect the equipment into an outlet on a circuit different from that to which the receiver is connected.
- 4) Consult the dealer or an experienced radio/TV technician for help.

### FCC RF Radiation Exposure Statement

This equipment complies with FCC radiation exposure limits set forth for an uncontrolled environment. This equipment should be installed and operated with minimum distance 20cm between the radiator and your body. This transmitter must not be co-located or operating in conjunction with any other antenna or transmitter.

**FCC Caution:** Any changes or modifications not expressly approved by the party responsible for compliance could void the user's authority to operate this equipment.

### CAN ICES-3 (B) / NMB-3 (B)

This Class B digital apparatus complies with Canadian ICES-003.

(Cet appareil numérique de la Classe B conforme à la norme NMB-003 du Canada).

This device contains licence-exempt transmitter(s)/receiver(s) that comply with Innova-

tion, Science and Economic Development Canada's licence-exempt RSS(s). Operation is subject to the following two conditions:

- (1) This device may not cause interference.
- (2) This device must accept any interference, including interference that may cause undesired operation of the device.

L'émetteur/récepteur exempt de licence contenu dans le présent appareil est conforme aux CNR d'Innovation, Sciences et Développement économique Canada applicables aux appareils radio exempts de licence. L'exploitation est autorisée aux deux conditions suivantes :

- (1) L' appareil ne doit pas produire de brouillage;
- (2) L' appareil doit accepter tout brouillage radioélectrique subi, même si le brouillage est susceptible d' en compromettre le fonctionnement.

#### **USER MAINTENANCE INSTRUCTIONS**

- (1) Please fully charge the machine before storing it.
- (2) Turn off all power buttons.
- (3) To preserve the battery lifespan, please use and recharge at least once every 6 months.
- (4) Wring the cloth with water and wipe it clean in case of dirt.

#### **MOVING AND STORAGE INSTRUCTIONS**

- (1) Ensure proper ventilation while in use or store and keep away from any combustible materials or gases. Do not stack anything on top of the unit in storage or in use. Inadequate ventilation and/or improper storing may cause damage to the unit.
- (2) Avoid exposing the product to rain or using the product in humid environment.
- (3) Use and store the product in a clean and dry environment.
4. Keep this product away from children and pet.

## 5.4 Important Instructions

INSTRUCTIONS PERTAINING TO RISK OF FIRE, ELECTRIC SHOCK, OR INJURY TO PERSONS

IMPORTANT SAFETY INSTRUCTIONS, SAVE THESE INSTRUCTIONS

WARNING – When using this product, basic precautions should always be followed, including the following:

- a) Read all the instructions before using the product.
- b) To reduce the risk of injury, close supervision is necessary when the product is used near children.
- c) Do not put fingers or hands into the product. DO NOT insert foreign objects into any ports of the machine. Please operate it carefully and keep children away from it.
- d) Use of an attachment not recommended or sold by power pack manufacturer may result in a risk of fire, electric shock, or injury to persons.
- e) To reduce risk of damage to the electric plug and cord, pull the plug rather than the cord when disconnecting the power pack.
- f) Do not use a battery pack or appliance that is damaged or modified. Damaged or modified batteries may exhibit unpredictable behavior resulting in fire, explosion or risk of injury.
- g) Do not operate the power pack with a damaged cord or plug, or a damaged output cable.
- h) DO NOT attempt to replace the internal battery or any other component of the equipment by anyone other than authorized personnel. There are no end-user serviceable components. Do not disassemble the power pack, take it to a qualified service person when service or repair is required. Incorrect reassembly may result in a risk of fire or electric shock.
- i) To reduce the risk of electric shock, unplug the power pack from the outlet before attempting any instructed servicing.
- j) WARNING – RISK OF EXPLOSIVE GASES. To reduce risk of battery explosion, follow these instructions and those published by battery manufacturer and manufacturer of any equipment you intend to use in vicinity of the battery. Review cautionary marking on these products and on engine.
- k) PERSONAL PRECAUTIONS
  - 1) Wear complete eye protection and clothing protection. Avoid touching eyes while working near battery.

- 2) NEVER smoke or allow a spark or flame in vicinity of battery or engine.
- 3) Be extra cautious to reduce risk of dropping a metal tool onto battery. It might spark or short-circuit battery or other electrical part that may cause explosion.
- l) When charging the internal battery, work in a well ventilated area and do not restrict ventilation in any way.
- m) Under abusive conditions, liquid may be ejected from the battery; avoid contact. If contact accidentally occurs, flush with water. If liquid contacts eyes, additionally seek medical help. Liquid ejected from the battery may cause irritation or burns.
- n) DO NOT place the power station near heat sources. It is prohibited to place the equipment in an environment with flammable, explosive gas, or smoke. It is also prohibited to operate the equipment in this environment. Do not expose a power pack to fire or excessive temperature. Exposure to fire or temperature above 130° C may cause explosion.
- o) Have servicing performed by a qualified repair person using only identical replacement parts. This will ensure that the safety of the product is maintained.
- p) DO NOT operate in wet conditions. If the equipment becomes wet, please let the unit dry completely before using.
- q) Please ensure proper ventilation while in use and do not obstruct fan openings. Inadequate ventilation may cause permanent damage to equipment.
- r) DO NOT stack anything on top of the power station while in storage or while in use. DO NOT move the unit while operating as vibrations and sudden impacts may lead to poor connections to the hardware inside.
- s) In case of fire, only a dry powder fire extinguisher is suitable for the product.
- DANGER:** This device is intended to be used indoors only. Do not use outdoors.

## CONSIGNES DE SÉCURITÉ IMPORTANTES

AVERTISSEMENT: lors de l'utilisation de ce produit, les précautions de base doivent toujours être respectées, y compris les éléments suivants:

A) lire toutes les instructions avant d'utiliser le produit.

B) pour réduire le risque de blessure, une surveillance étroite est nécessaire lorsque le produit est utilisé à proximité des enfants.

C) ne pas mettre les doigts ou les mains dans le produit. Ne pas insérer d'objets étrangers dans les ports de la machine. S'il vous plaît, faites attention et éloignez les enfants.

D) l'utilisation d'un accessoire non recommandé ou vendu par le fabricant du groupe d'alimentation peut entraîner un risque d'incendie, de choc électrique ou de blessure.

E) pour réduire les risques d'endommagement de la prise et du cordon électriques, débrancher la prise plutôt que le cordon lors de la déconnexion de la centrale.

F) n'utilisez pas de batterie ou d'appareil endommagé ou modifié. Les batteries endommagées ou modifiées peuvent présenter un comportement imprévisible entraînant un incendie, une explosion ou un risque de blessure.

G) ne pas faire fonctionner le groupe d'alimentation avec un câble ou une prise endommagée ou un câble de sortie endommagé.

H) ne tentez pas de remplacer la batterie interne ou tout autre composant de l'équipement par quelqu'un d'autre que le personnel autorisé. Il n'y a pas de composants utilisables par l'utilisateur final. Ne démonter pas la batterie, l'amener à une personne qualifiée lorsque l'entretien ou la réparation est nécessaire. Un mauvais réassemblage peut entraîner un risque d'incendie ou de choc électrique.

I) pour réduire le risque de choc électrique, débrancher le bloc d'alimentation de la prise avant de procéder à tout entretien.

J) avertissement - risque de gaz explosifs. Pour réduire le risque d'explosion de la batterie, suivez ces instructions ainsi que celles publiées par le fabricant de la batterie et le fabricant de tout équipement que vous avez l'intention d'utiliser à proximité de la batterie. Revoir le marquage de mise en garde sur ces produits et sur le moteur.

K) précautions individuelles

1) porter une protection complète des yeux et des vêtements. Évitez de toucher les yeux en travaillant près de la batterie.

2) ne jamais fumer ou laisser une étincelle ou une flamme à proximité de la batterie ou du moteur.

3) être très prudent pour réduire le risque de tomber un outil métallique sur la batterie. Il peut étinceler ou court-circuiter une batterie ou une autre partie électrique qui peut causer une explosion.

L)lors du chargement de la batterie interne, travailler dans une zone bienventilée et ne pas restreindre la ventilation.

M)dans des conditions abusives, le liquide peut être éjecté de la batterie;Évitezle contact.En cas de contact accidentel, rincer à l'eau.Si le liquide entre encontact avec les yeux, consulter un médecin.Le liquide éjecté de la batteriepeut provoquer des irritations ou des brûures.

N)ne pas placer la centrale à proximité des sources de chaleur.Il est interdit deplacer l'équipement dans un environnement contenant des gaz inflammables,explosifs ou de la fumée.Il est également interdit d'utiliser le matériel danscet environnement.Ne pas exposer une centrale électrique au feu ou à unetempérature excessive.Une exposition à un incendie ou à une températuresupérieure à 130° C peut provoquer une explosion.La température de 130° Cpeut être remplacée par la température de 265° F.

O)faire effectuer l'entretien par un réparateur qualifié utilisant uniquementdes pièces de rechange identiques.Cela garantira le maintien de la sécurité duproduit.

P)ne pas opérer dans des conditions humides.Si le matériel se mouille, laissezsécher complètement l'appareil avant utilisation.

Q)assurer une bonne ventilation pendant l'utilisation et ne pas obstruerles ouvertures des ventilateurs.Une ventilation inadéquate peut causer desdommages permanents aux équipements.

R)n'empilez rien sur la centrale pendant son stockage ou son utilisation.Ne déplacez pas l'unité lorsque les vibrations et les chocs soudains peuventconduire à de mauvaises connexions avec le matériel à l'intérieur.

S)en cas d'incendie, seul un extincteur à poudre sèche convient au produit.

DANGER: ce dispositif est destiné à être utilisé uniquement à l'intérieur.Ne pasutiliser à l'extérieur.

## For more information, please visit:

Web: <https://www.bluettipower.com>



@ BLUETTI Support

@ BLUETTI Official



@ bluetti\_inc



@bluetti.inc



@bluetti\_official



service@bluettipower.com

### SHENZHEN POWEROAK NEWENER CO., LTD.

Add: F19, BLD No.1, Kaidaer, Tongsha Rd No.168, Xili Street,  
Nanshan, Shenzhen, China

### USA Agent

Company name: BLUETTI POWEROAK INC

Address: 6185 S VALLEY VIEW BLVD STE D LAS VEGAS  
NEVADA 89118 United States

FRN: 0033559824

Contact Name: Qiyao Li

Telephone No: +1-512-966-1898 1

Email: liqy@bluetti.com



**BLUETTI**



Just Power On