

# SPECS

## TURTLE CHANDELIER

Namit Khanna

Length S 31.50/M 37.00/L 47.00 inches

Breadth S 31.50/M 37.00/L 47.00 inches

Height S 31.50/M 37.00/L 47.00 inches

Material Iron

Finishes EPL Gold



Dust with soft cloth

Do not use abrasive cleaners on metal

Manufactured by -

Nodi India, Moradabad,  
India

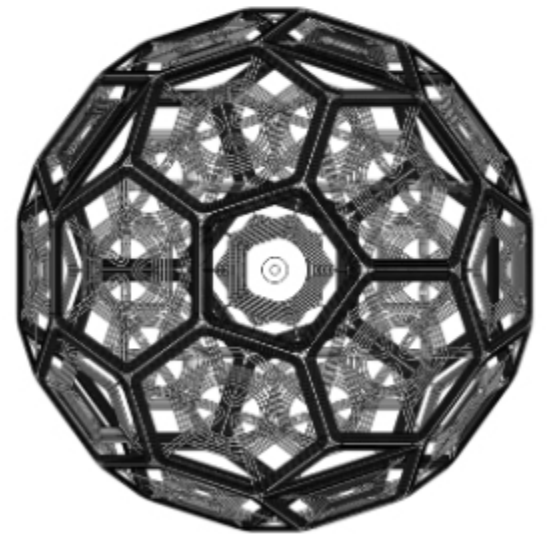

# SCALE - S

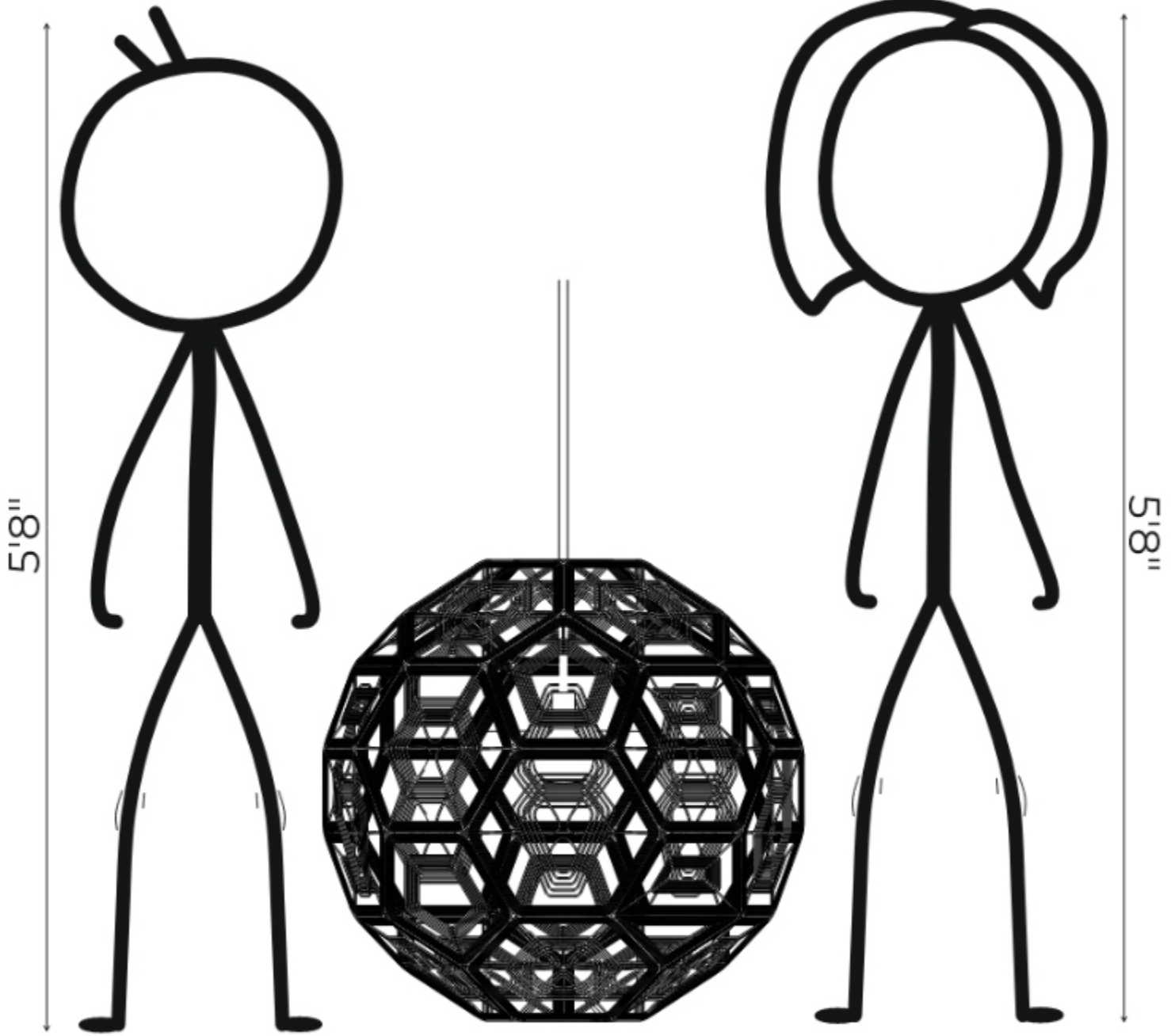

SCALE - M

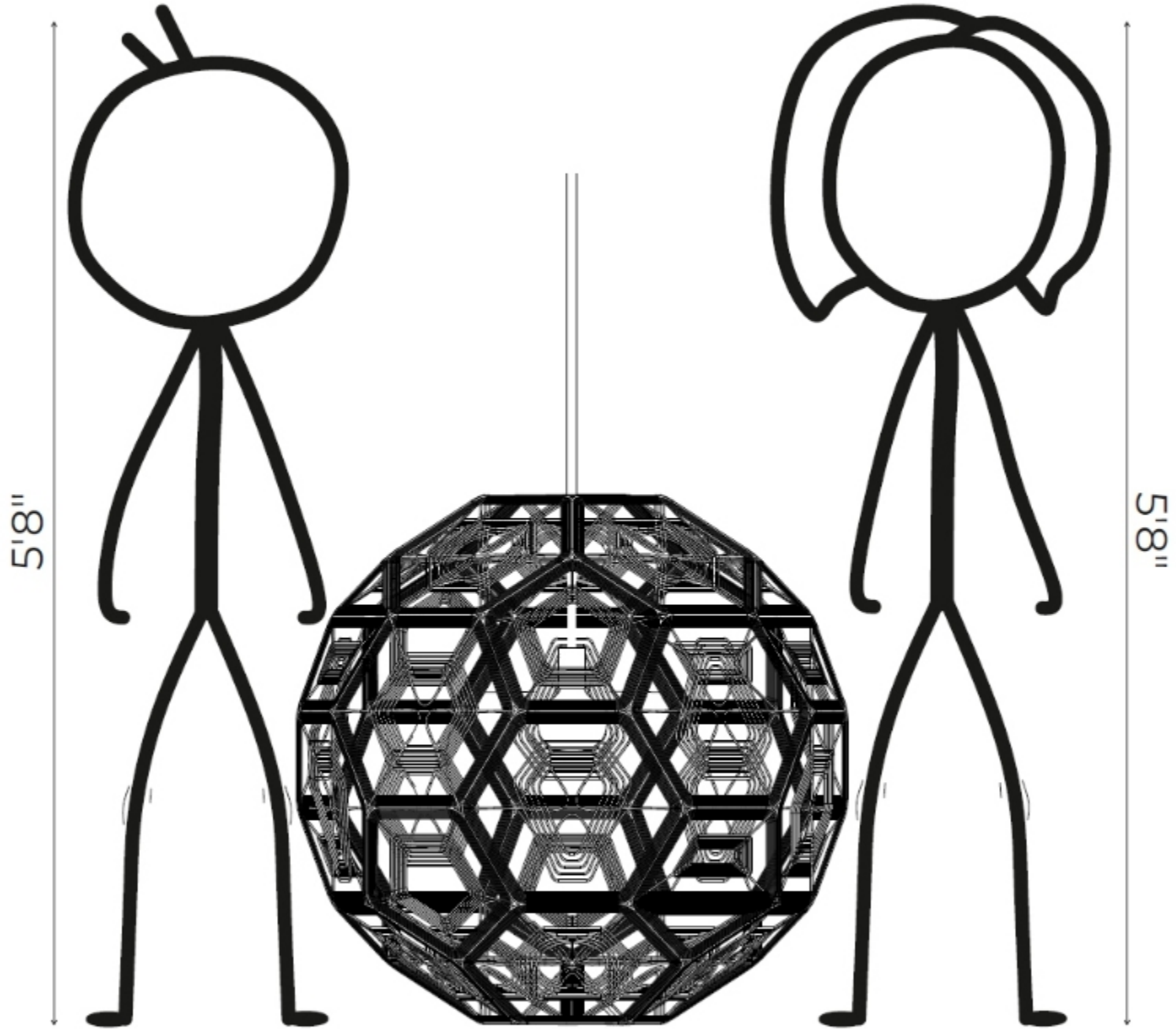

SCALE - L

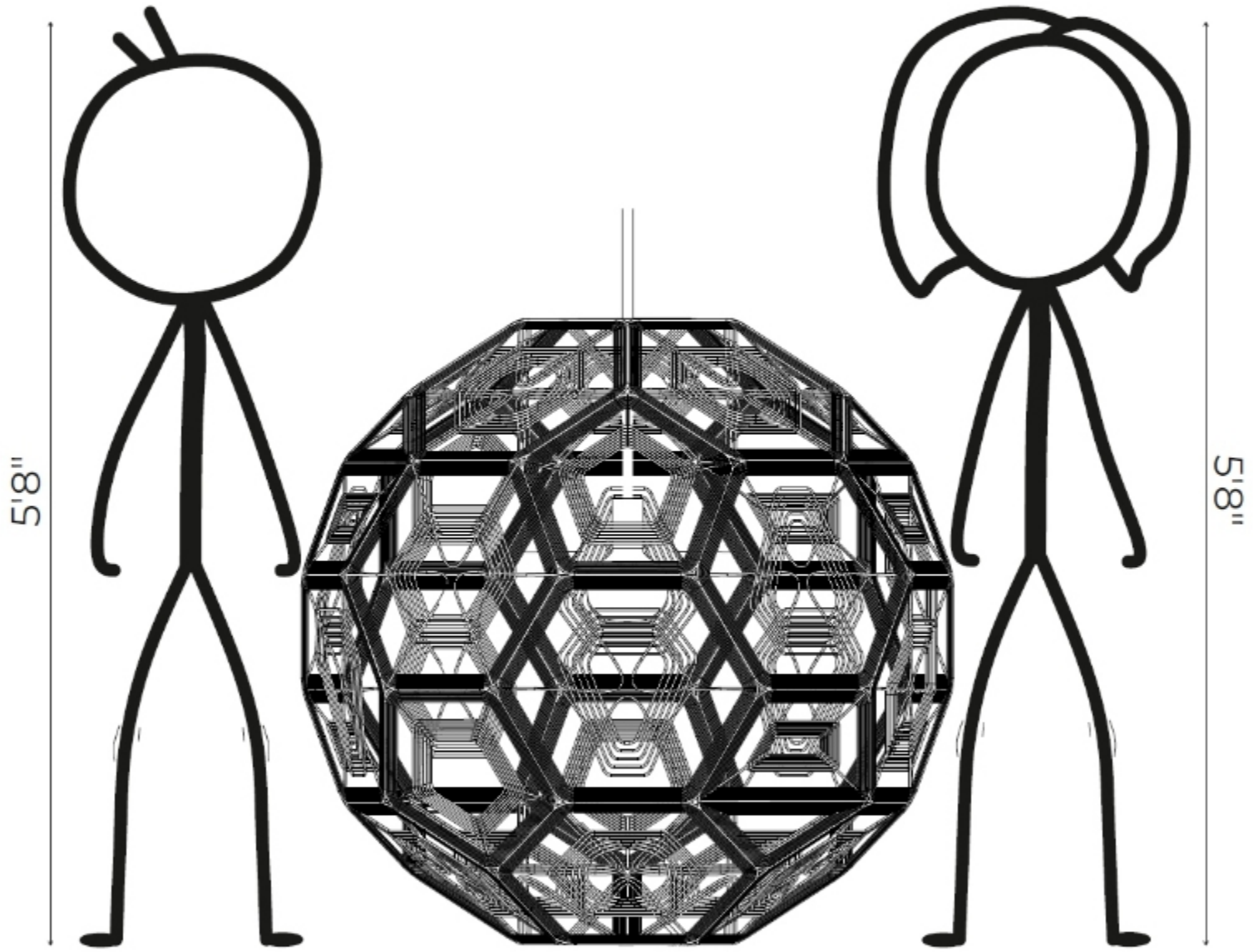

NAMA<sup>TM</sup>  
*Home*

| *Damit Khanna*

nnnnnnnn  
nnnnnnnn  
nnnnnnnn  
nnnnnnnn  
nnnnnAQA  
*Home*

# TURTLE CHANDELIER

by

Namit Khanna



NAMA<sup>™</sup>  
*Home*

# PART



Chain length 29 inches

Bulb - 4w  
(Yellow Edison Filament Bulb.)

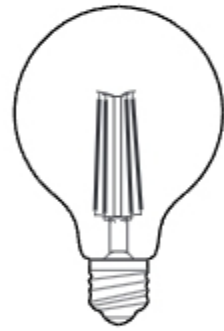

E-27P Bulb Holder.





31.50/37.00 inches  
Need to open window to fix the bulb

1

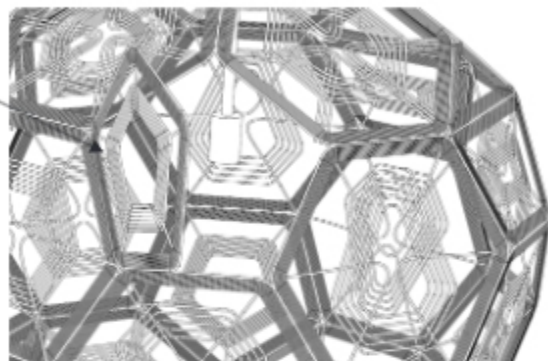

2

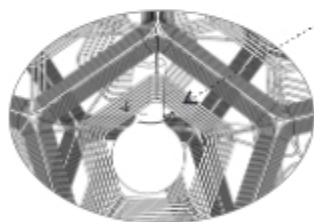
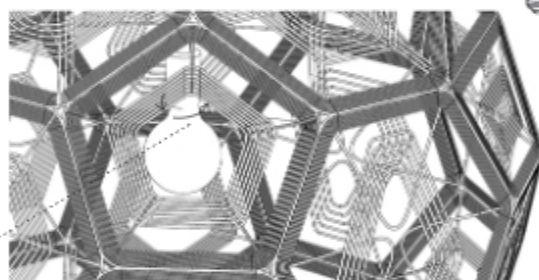
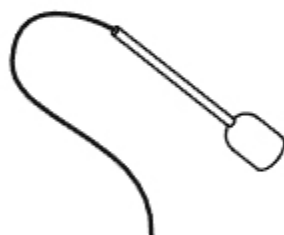

**3**

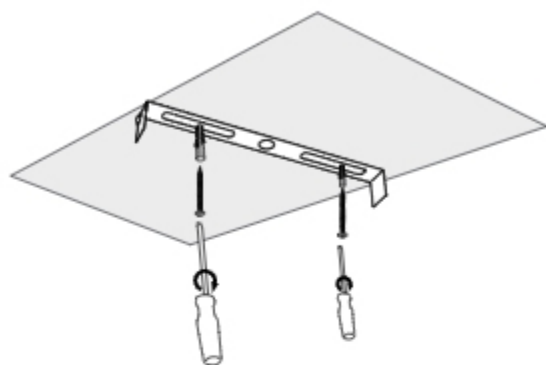

**4**

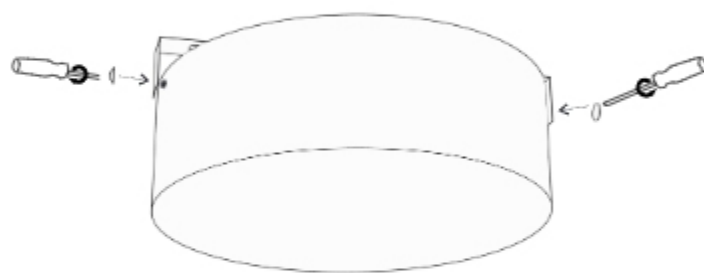

**5**



6



PLEASE HANDLE THIS PRODUCT WITH CARE.  
NEVER PLACE THE LAMP ON THE GROUND. THIS MAY DAMAGE THE  
PRODUCT