

Applicable size

Catalogue

- Applicable size01
- Product components03
- 1.Passcode: Flow chart04
- 2.RFID card:Flow char
- 3.Other settings: Flow chart05
- Accessories list (TOOL BOX)06
- Install battery
- Adjust the length of the cylinder07
- Installation pictures
- Uresetting diagram
- Unlock and lock08
- FAQ
- Bluetooth activation and login instructions09
- Select"Android/iOS"to download
- Log in to the app
- Bind the device10
- Specifications11
- Operating instruction

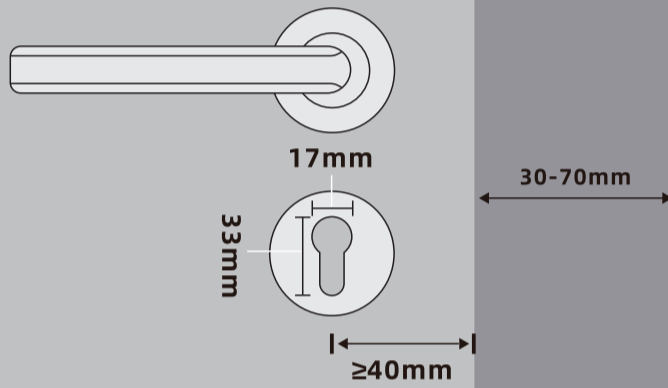

Product Components

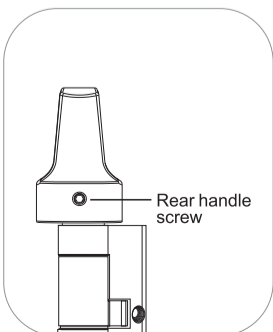
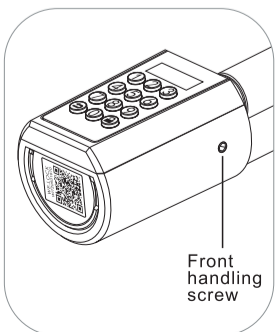
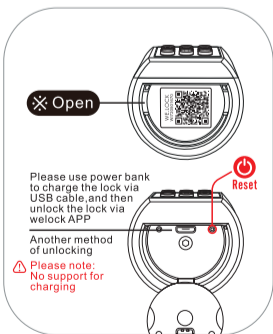
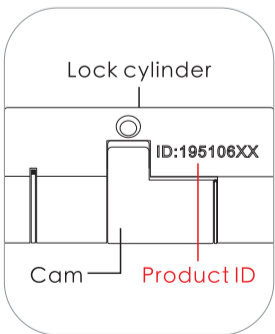
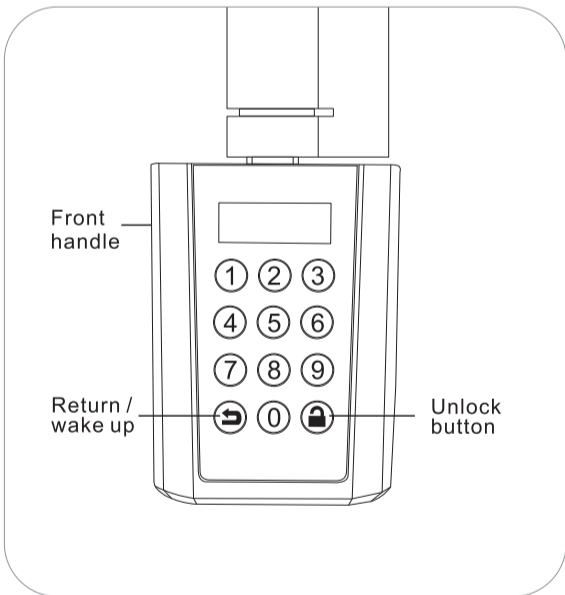

1.Passcode: flow chart

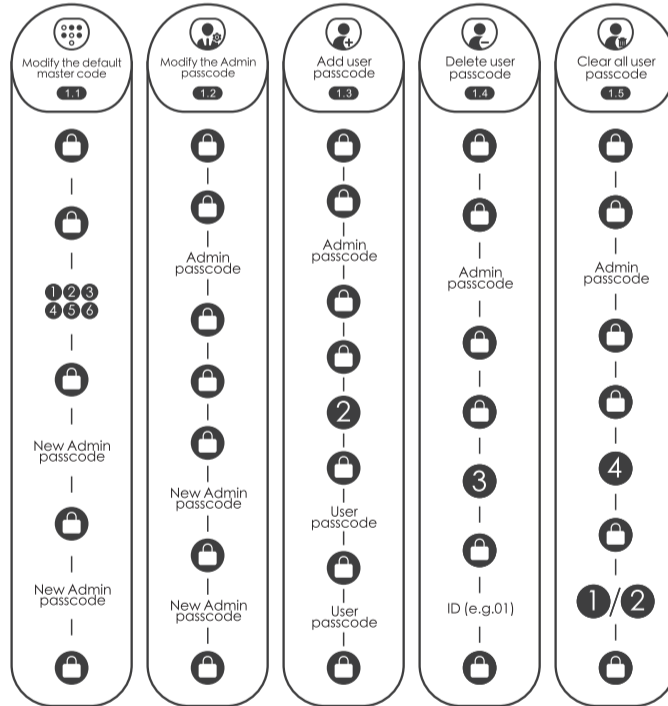

3.Other settings: Flow chart

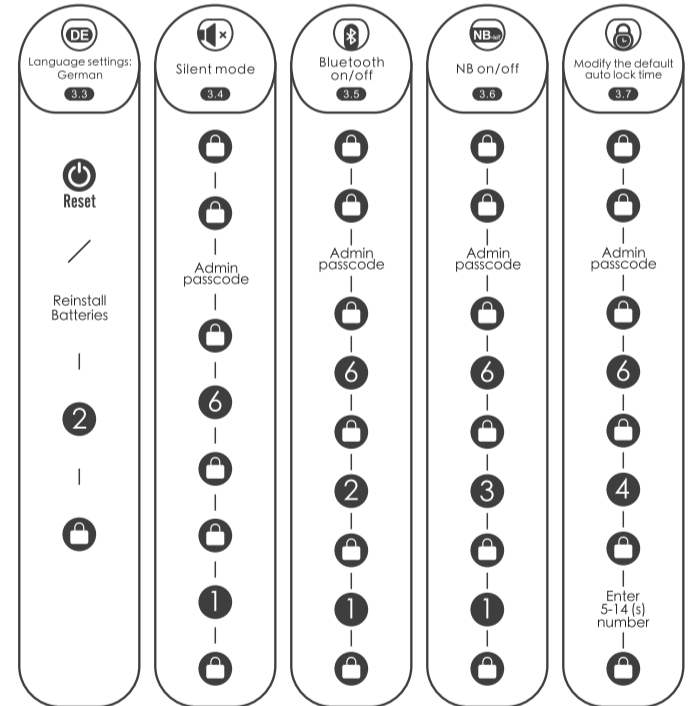

2.RFID card: Flow char

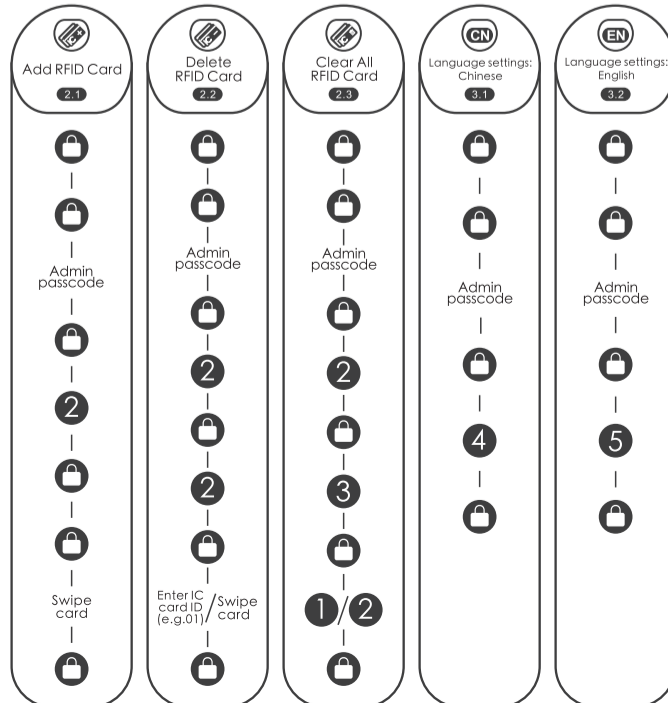

3.Other settings: Flow chart

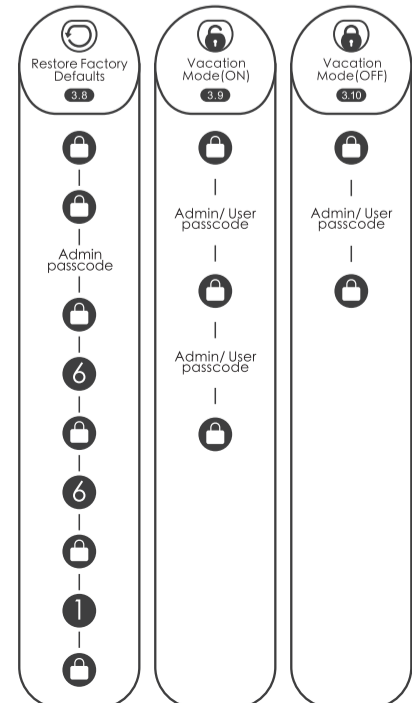

Accessories list (TOOL BOX)

If there is lack of accessories, please contact customer service in time.

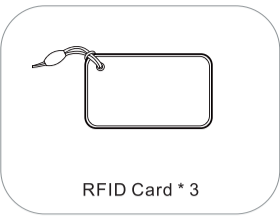

RFID Card * 3

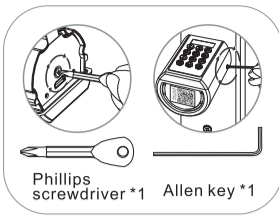

Phillips screwdriver *1 Allen key *1

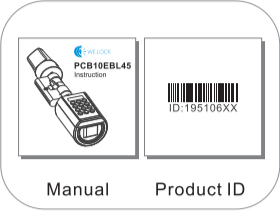

Manual Product ID

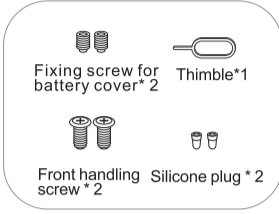

Fixing screw for battery cover * 2 Thimble*1
Front handling screw * 2 Silicone plug * 2

Install battery

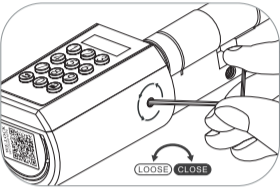

1. Loosen the screws with allen key

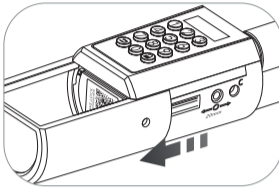

2. Open the stainless steel cover

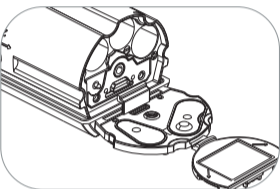

3. Open the battery cover

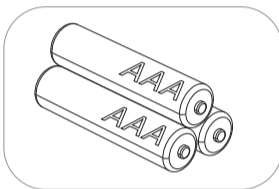

4. 3 * AAA battery (Please buy it by yourself)

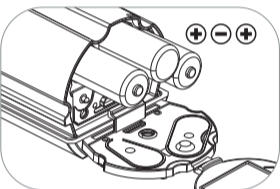

5. Install battery

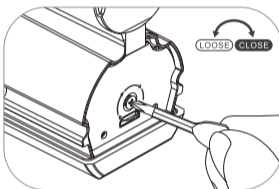

6. Fix the battery cover and tighten the screws

- 06 -

Adjust the length of the cylinder

Depending on the required cylinder length you can adjust the interior and exterior length by loosening the screw with the screwdriver and then pulling out the handle upon need. Tighten the screws after adjustment and plug the adjustment holes with silicone plug, which can play a certain waterproof effect.

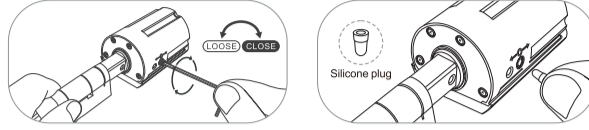
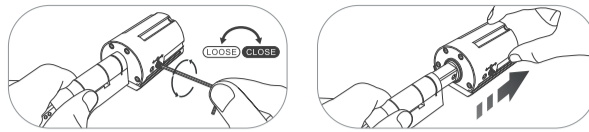

Due to the security reason, the front handle cannot be taken off.

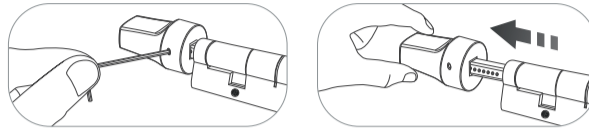

Installation pictures



1. Remove the fixing screw and original cylinder

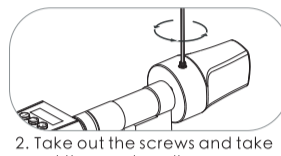

2. Take out the screws and take out the rear handle

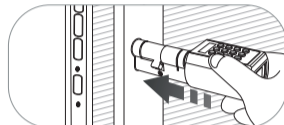

3. The lock cylinder is installed into the lock hole from the outside



4. Installation Fixing screws

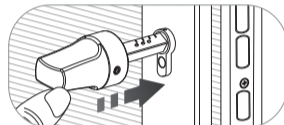

5. Install rear handle

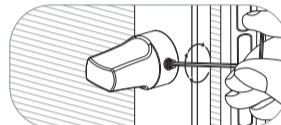

6. Fixed rear handle screw

Resetting diagram

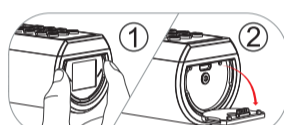

1. Opening the silicone cover

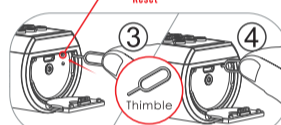

2. Find the Thimble in the attached accessories

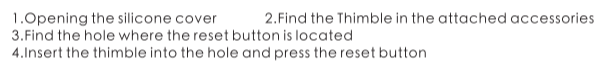

3. Find the hole where the reset button is located



4. Insert the thimble into the hole and press the reset button

- 07 -

Unlock and lock

Unlock the door from outside

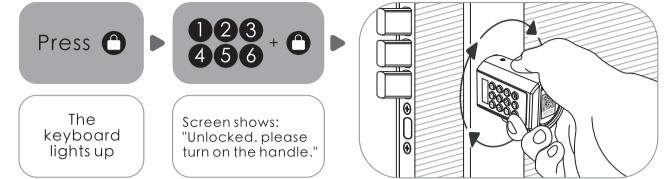

Press

1 2 3 +
4 5 6

The keyboard lights up

Screen shows: "Unlocked, please turn on the handle."

The knob can be rotated 360 degree freely after locked.

To protect the lock not be damaged by torsion forcefully.

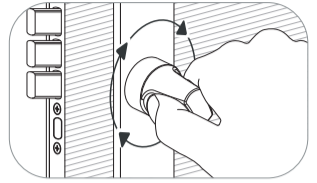

Low battery prompt:

After waking up, the screen displays:



Battery Low

FAQ

- What should I do when I receive the lock?**
When you received the lock, please modify the default password "123456" to your own admin password first, so please keep it in your mind.
- Where can I find the lock ID?**
Please find the lock ID with 8 digits number on the middle of lock, or find it on packing box.
- When will the low battery alarm?**
The battery is below 20%.
- What is the USB backup key for?**
USB backup key is spare key, for emergency situations, like when the lock is broken or battery run out, then you can use power bank to charge the lock via USB cable, then use our app to unlock the lock.
- How can contact customer service?**
Please contact this email: Service@WelockGlobal.com

- 08 -

Bluetooth activation and login instructions

Scan the QR code on the lock



Select "Android/iOS" to download



Log in to the app

- Select your country/region
- Enter the phone number/email to get the verification code
- Click "Send"
- Enter the verification code after receiving the message
- Click "Login"

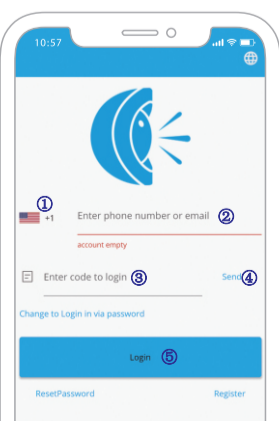

- 09 -

Bind the device

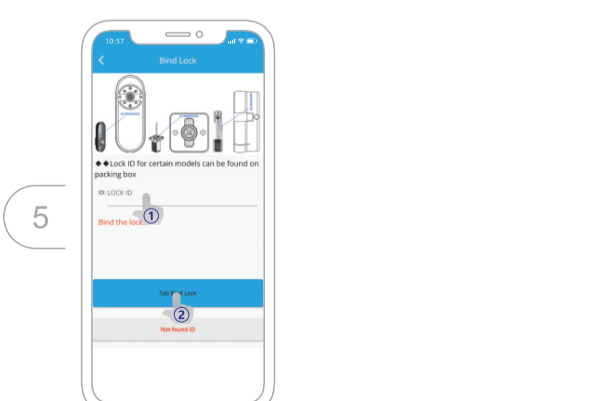
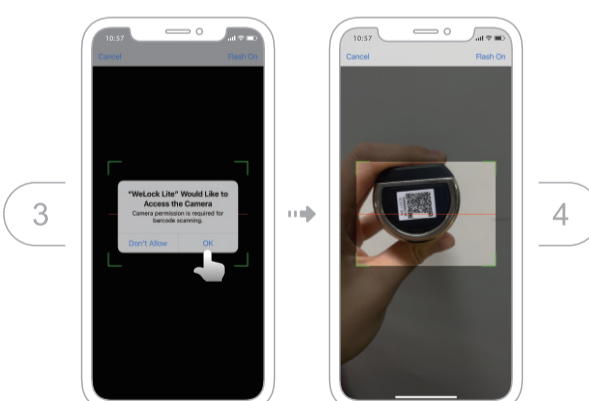
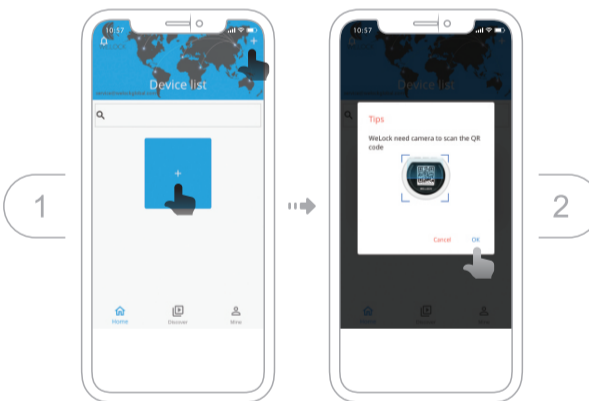

- 10 -

Specifications

Brand	WE.LOCK
Applicable door types	Wooden doors, interior doors
Adjustable range	30-70 mm
Operating Temperature	-25°C - 60°C
Pressing Cycle Times	100,000 Times
Material of handle	Zinc Alloy
Way to unlock	Passcode / IC card / Bluetooth
Battery Type	3*AAA Battery
Power input	3.6V-4.5V
Battery Replacement	Replaceable
Color	Silver
Battery Life	10-12 months

Operating instruction

- Enter the wrong passcode 5 times continuously. the system is locked for three minutes and cannot operate.
- Press **⏻** to wake up the keyboard+10 digits temporary passcode Enter the wrong passcode 5 times continuously, the system is locked for three minutes and the cannot operate. Temporary passcode generation needs to be done in the App. The time on the screen should be the same as the time on the phone, otherwise the temporary passcode will be invalid.
- Press **⏻** to wake up the keyboard+ swipe the IC cards Swipe the unmatched card 5 times continuously, the system is locked for three minutes and the cannot operate. Any IC card can unlock the door in factory state.
- Bind the lock on APP
Bind the lock on APP via Bluetooth, click "unlock", and the phone time will be synchronized to the lock via Bluetooth.

- 11 -