

S SPIRIT
COMMERCIAL

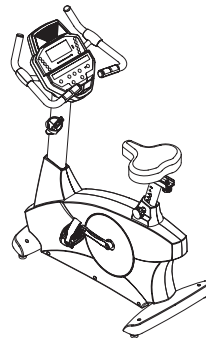

CU800 FITNESS BIKE

OWNER'S MANUAL

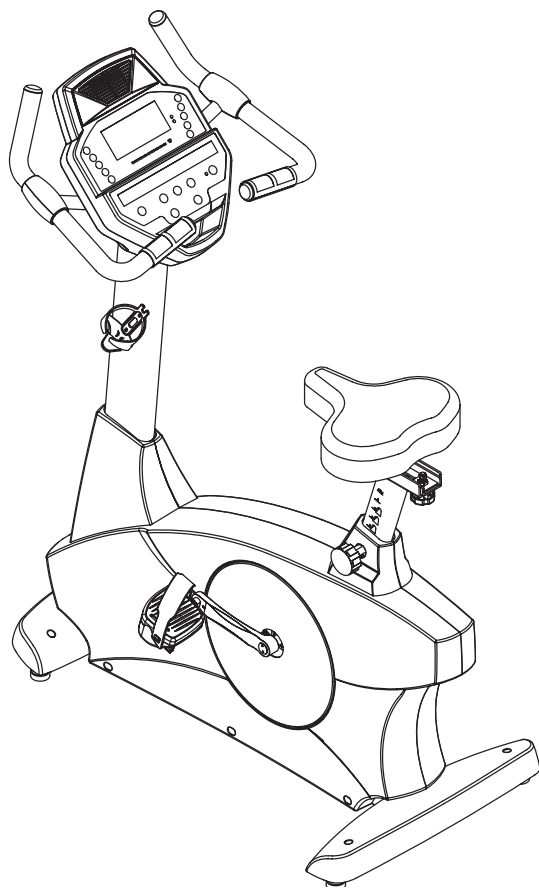

TABLE OF CONTENTS

3	IMPORTANT SAFETY INSTRUCTIONS
3	IMPORTANT ELECTRICAL INSTRUCTIONS
4	IMPORTANT OPERATION INSTRUCTIONS
5	PRODUCT REGISTRATION
7	CU800 ASSEMBLY INSTRUCTIONS
12	CONSOLE OPERATION
17	PROGRAMMABLE FEATURES
31	WEARING THE CHEST STRAP
35	GENERAL MAINTENANCE
36	MANUFACTURER'S LIMITED WARRANTY

Thank you for purchasing our product, please save these instructions. Please do not perform or attempt any customizing, adjustments, repair or maintenance that is not described in this manual.



Congratulations on your new fitness bike and welcome to the Spirit Fitness family!

Thank you for your purchase of this quality fitness bike from Spirit Fitness. Your new fitness bike was manufactured by one of the leading fitness manufacturers in the world and is backed by one of the most comprehensive warranties available. Through your dealer, Spirit Fitness will do all we can to make your ownership experience as pleasant as possible for many years to come. If not purchased direct from Spirit Fitness, the local dealership where you purchased this fitness bike is your administrator for all Spirit Fitness warranty and service needs. Their responsibility is to provide you with the technical knowledge and service personnel to make your experience more informed and any difficulties easier to remedy.

Please take a moment at this time to record the name of the dealer, their telephone number, and the date of purchase below to make any future, needed contact easy. We appreciate your support and we will always remember that you are the reason that we are in business.

Yours in Health,
Spirit Fitness

NAME OF DEALER _____

DEALER PHONE # _____

PURCHASE DATE _____

IMPORTANT SAFETY INSTRUCTIONS

WARNING

- Before beginning this or any exercise program, consult a physician. This is especially important for persons over the age of 35 or persons with pre-existing health conditions.
- Keep children away from the fitness bike. There are obvious pinch points and other caution areas that can cause harm.
- Keep hands away from all moving parts.
- Never drop or insert any object into any openings.
- Do not use outdoors.
- Do not attempt to use your fitness bike for any purpose other than for the purpose it is intended.
- The hand pulse sensors are not medical devices. Various factors, including the user's movement, may affect the accuracy of heart rate readings. The pulse sensors are intended only as exercise aids in determining heart rate trends in general.
- Wear proper shoes. High heels, dress shoes, sandals or bare feet are not suitable for use on your fitness bike. Quality athletic shoes are recommended

to avoid leg fatigue.

- Maximum User Weight: 450 lbs
- This appliance is not intended for use by persons with reduced physical, sensory or mental capabilities, or lack of experience and knowledge, unless they have been given supervision or instruction concerning use of the appliance by a person responsible for their safety.
- Keep children under the age of 13 away from this machine.

SAVE THESE INSTRUCTIONS - THINK SAFETY!

IMPORTANT ELECTRICAL INSTRUCTIONS

WARNING

Be aware that the generator is producing A.C. power while the fitness bike is being used. Do not service the fitness bike while the generator is spinning; serious electric shock could occur.

NEVER expose this fitness bike to rain or moisture. This product is **NOT** designed for use outdoors,

near a pool or spa, or in any other high humidity environment. The operating temperature specification is 40 to 120 degrees Fahrenheit, and humidity is 95% non-condensing (no water drops forming on surfaces).

IMPORTANT OPERATION INSTRUCTIONS

- **NEVER** operate this fitness bike without reading and completely understanding the results of any operational change you request from the computer.
- Understand that changes in resistance do not occur immediately. Set your desired resistance level on the computer console and release the adjustment key. The computer will obey the command gradually.
- Use caution while participating in other activities while pedaling on your fitness bike; such as watching television, reading, etc. These distractions may cause you to lose balance which may result in serious injury.
- Do not use excessive pressure on console control keys. They are precision set to function properly with little finger pressure.

RECORD YOUR SERIAL NUMBER

Please record the serial number of this fitness product in the space provided below.

Serial Number:

Serial Number Location

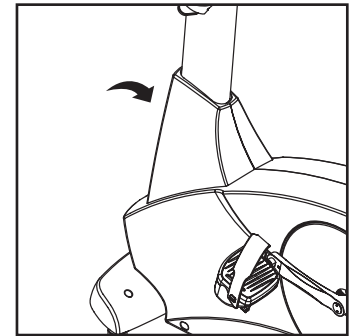

REGISTER YOUR PURCHASE

The self-addressed product registration card must be completed in full and returned to Spirit Fitness. You can also go to <http://www.spiritfitness.com/commercialwarrantyregistration.html> under the Support tab to register online.

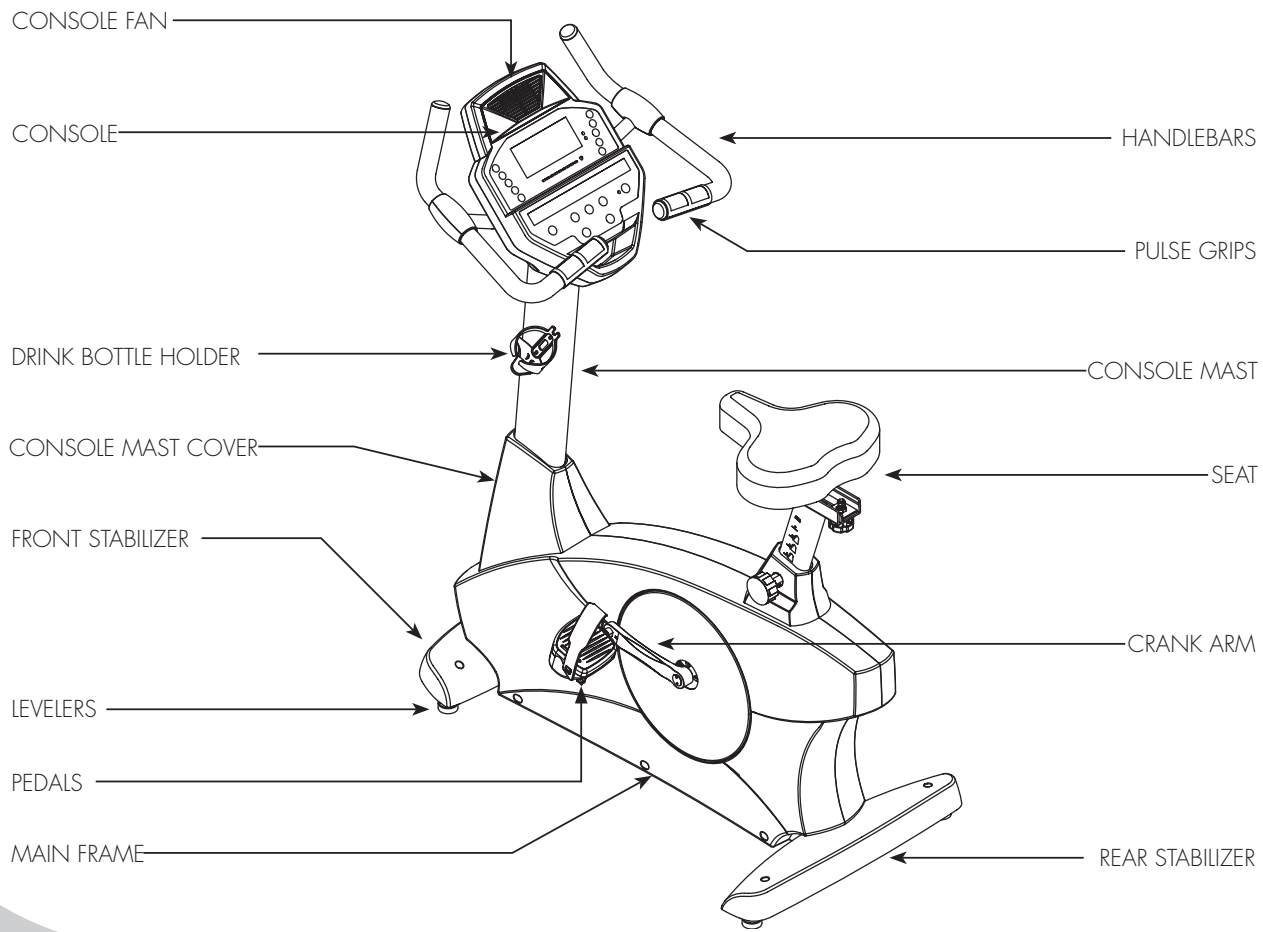

CUBOO PRE-ASSEMBLY

UNPACKING

1. Cut the straps, then along the dotted line on the bottom of the box; lift the box over the unit and unpack.
2. Locate the hardware package. The hardware is separated into four steps. Remove the tools first. Remove the hardware for each step as needed to avoid confusion. The numbers in the instructions that are in parenthesis (#) are the item number from the assembly drawing for reference.

TOOLS INCLUDED:

- 13/15mm Wrench
- 12/14mm Wrench
- Phillips Screwdriver

PARTS INCLUDED:

- 1 Main Frame
- 1 Rear Stabilizer
- 1 Console Mast
- 1 Handle Bar
- 1 Console Mast Cover
- 1 Front Stabilizer Cover
- 1 Rear Stabilizer Cover
- 1 Console
- 1 Drink Bottle Holder
- 2 Pedals
- 1 Hardware Kit

CUB00 STEP ONE

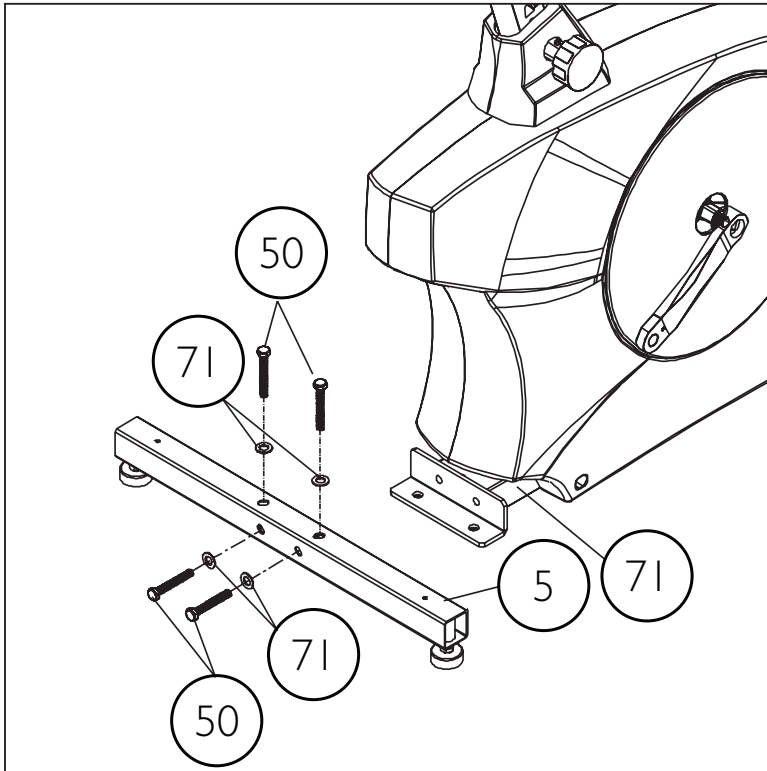

HARDWARE FOR STEP 1			
PART	TYPE	DESCRIPTION	QTY
50	BOLT	3/8"X2-1/4"	4
71	WASHER	3/8"X25"	4

1. Gather **HARDWARE FOR STEP 1**.
2. Install the **REAR STABILIZER (5)** onto the **MAIN FRAME (1)** with the 4 **BOLTS (50)** and 4 **WASHERS (71)**.

CUBOO STEP TWO

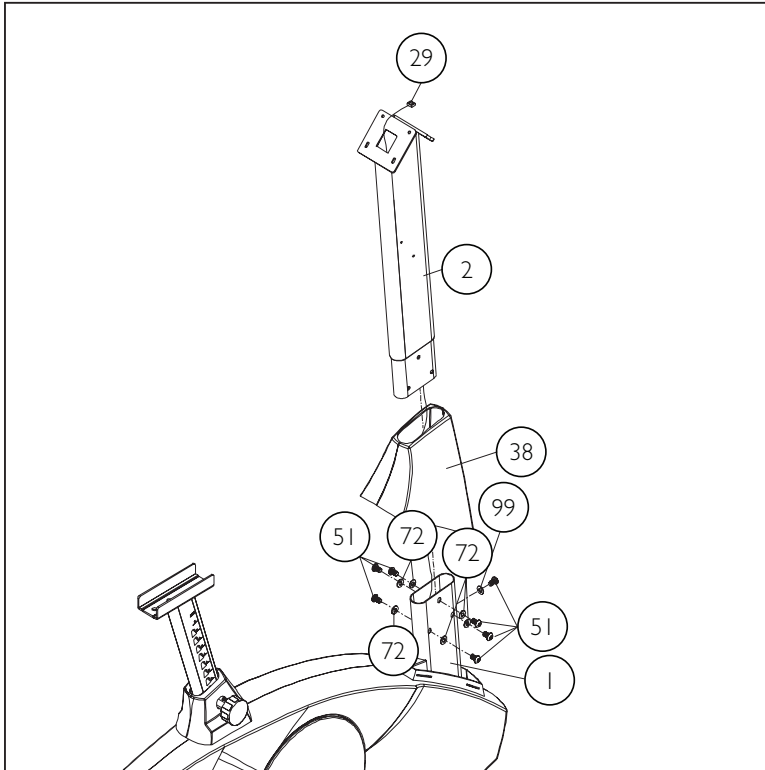

HARDWARE FOR STEP 1			
PART	TYPE	DESCRIPTION	QTY
51	BOLT	5/16"X5/8"	7
72	FLAT WASHER	5/16"X18	6
99	CURVED WASHER	5/16"X19"	1

1. Gather **HARDWARE FOR STEP 2**.
2. Unravel the **COMPUTER CABLE (29)** and snake it through the **CONSOLE MAST COVER (38)** and the **CONSOLE MAST (2)** until the cable connector comes out the top opening of the console mast. Slide the **PLASTIC COVER (38)** onto the **CONSOLE MAST**, ensuring the correct orientation of the cover.
3. Install the **CONSOLE MAST (2)** onto the **MAIN FRAME (1)** with 7 **BOLTS (51)**, 6 **WASHERS (72)** on the side screws and 1 **CURVED WASHER (99)** on the front screw.

CUB800 STEP THREE

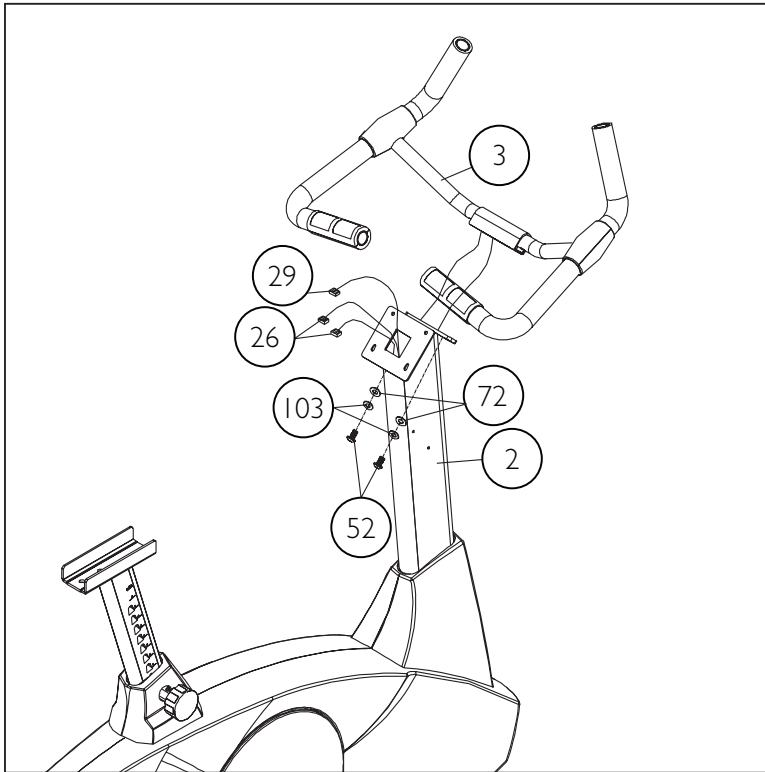

HARDWARE FOR STEP 3			
PART	TYPE	DESCRIPTION	QTY
51	BOLT	5/16"X5/8"	2
72	WASHER	5/16"X18"	2
103	FLAT WASHER	5/16"	2

1. Gather **HARDWARE FOR STEP 3**.
2. Run the 2 **HAND PULSE WIRES (26)** into the hole in the handle bar mounting plate and out through the hole in the console plate. Install the **HANDLE BAR (3)** onto the **CONSOLE MAST (2)** with 2 **BOLTS (51)**, 2 **WASHERS (72)** and 2 **SPLIT WASHERS (103)** being careful not to pinch the hand pulse wires. Snap the black plastic handlebar cover over the joint.

CU800 STEP FOUR

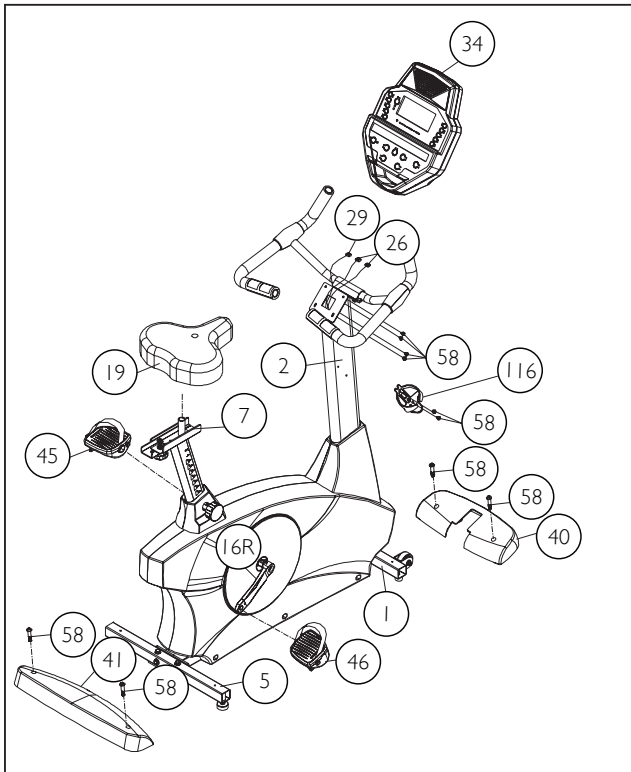

HARDWARE FOR STEP 4

PART	TYPE	DESCRIPTION	QTY
58	SCREW	M5X12MM	10

1. Gather **HARDWARE FOR STEP 4**.
2. Insert the **COMPUTER CABLE (29)** and 2 **HAND PULSE CABLES (26, 28)** into the connectors in the back of the **CONSOLE (34)**. Install the **CONSOLE (34)** onto the **CONSOLE MAST (2)**. Install the 2 bottom **SCREWS (58)** first. Install the **COVER PLATE (12)** with the 2 top **MOUNTING SCREWS (58)**.
3. Install the **FRONT STABILIZER COVER (40)** and the **REAR STABILIZER COVER (41)** onto the **MAIN FRAME (1)** with 4 **SCREWS (58)**.
4. Install the **PEDALS (45 L, 46 R)** onto the **CRANK ARMS (16 L, 16 R)**. The left pedal has a reverse thread and will be screwed in with the opposite rotation. Make sure to tighten the pedals as much as possible.
5. Install the **SEAT MOUNT SLIDE (7)** onto the track on top of the seat tube with the seat post facing forward. Install the **SEAT (19)** onto the seat post.
6. Install the **DRINK BOTTLE HOLDER (116)** onto the **CONSOLE MAST (2)** with 2 **SCREWS (58)**.



CU800 CONSOLE OPERATION

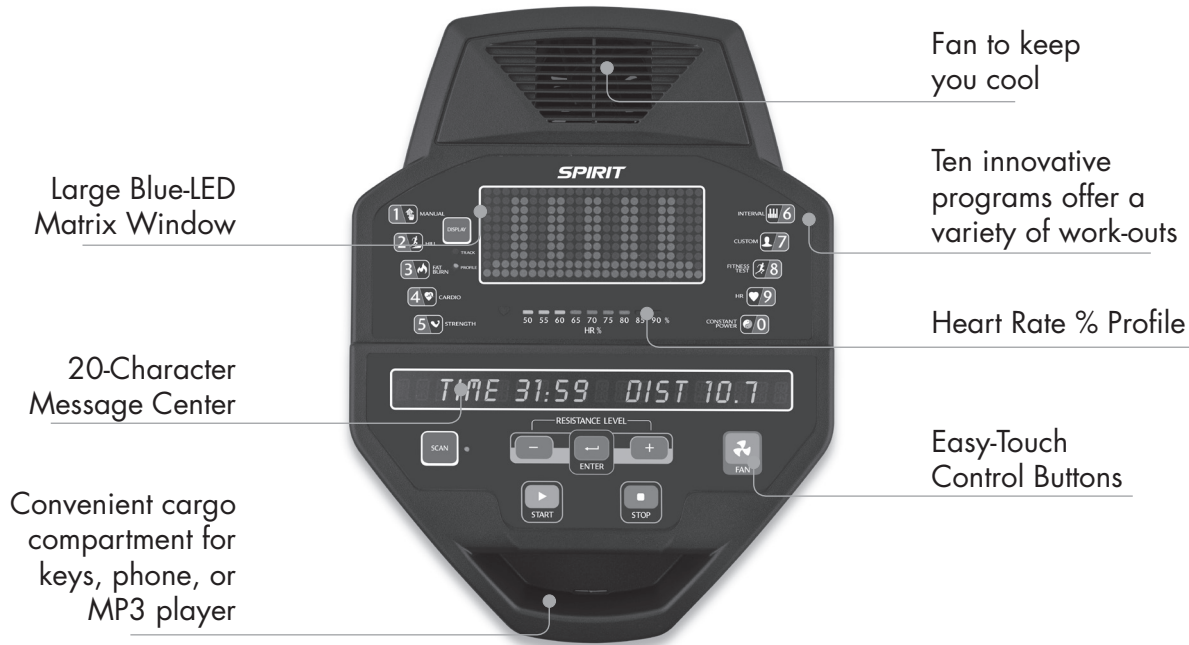

Large Blue-LED Matrix Window

20-Character Message Center

Convenient cargo compartment for keys, phone, or MP3 player

Fan to keep you cool

Ten innovative programs offer a variety of work-outs

Heart Rate % Profile

Easy-Touch Control Buttons

POWER

Spirit Fitness commercial fitness bikes have a built-in generator for power and do not need to be plugged into an AC outlet. To power up the fitness bike simply start to pedal, the console will turn on automatically.

When initially powered on the console will perform an internal self-test. During this time all the lights will turn on for a short time. When the lights go off the dot matrix display will show a software version (i.e. VER 1.0) and the **Message Window** will display an odometer reading. The odometer reading displays how many hours the fitness bike has been used and how many virtual miles the fitness bike has gone. The display shows: ODO 123 MI 123 HRS.

The odometer will remain displayed for only a few seconds then the console will go to the start up display. The dot matrix display will be scrolling through the different profiles, showing the programs, and the **Message Window** will be scrolling the start up message. You may now begin your workout program.

CSAFE FEATURE

Your console is equipped with a CSAFE feature. The Power (POWER) port can be used for powering a remote controlled audio-visual system by connecting a cable from the remote to the Power port at the back of the console. The Communication port (COMM) can be used to interact with fitness software applications.



QUICK START

This is the quickest way to start a workout. After the console powers up you just press the **Start** key to begin. This will initiate the Quick Start mode. In Quick Start the Time will count up from zero, all workout data will start to accrue and the workload may be adjusted manually by pressing the **Up** and **Down** buttons. The dot matrix display will show a ¼ mile (0.4km) track display or just the bottom row lit at first, depending on how the display button has been set (see Basic information below). As you increase the workload more rows will light indicating a harder workout. The fitness bike will get harder to pedal as the rows increase. The dot matrix has 24 columns of lights and each column represents 1 minute. At the end of the 24th column (or 24 minutes of work) the display will wrap around and start at the first column again.

There are 40 levels of resistance – displayed as 10 rows of lights - available for plenty of variety. The first 10 levels are very easy workloads, and the changes between levels are set to a good progression for de-conditioned users. Levels 10-20 are more challenging but the increases from one level to the next remain small. Levels 20-30 start getting tough as the levels jump more dramatically. Levels 30-40 are extremely hard and are good for short interval peaks and elite athletic training.

BASIC INFORMATION

The Dot Matrix, or Profile Window, has two display modes. When you begin a program the dot matrix will display the workout Profile. To the left of the dot matrix there is a button labeled **Display**. Pressing this button once will switch the display to show a quarter mile track. If the Display button is pressed again the dot matrix will switch back and forth between Track and Profile mode every few seconds. To turn off the scan mode press the **Display** key again. This will return you to the profile display mode.

The **Message Window** will initially be displaying **Time** and **Distance** information. On the bottom left of the **Message Window** is a button labeled **Display**. Each time this **Display** button is pressed the next

set of information will appear, four windows in all. In order: Time and **Distance**, **Pulse** and **Kcal (Calories)**, **Speed** in **RPM** and **MPH**, **Work Level** and **Watts**, then **METs**. If the **Display** button is pressed during the **METs** display the Scan light will come on and the **Message Window** will show each set of data for four seconds then switch to the next set of data in a continuous loop. Pressing the **Display** button again will bring you back to the beginning.

Below the Dot matrix display is a Heart Icon and a Bar Graph. The fitness bike has a built in heart rate monitoring system. Simply grasping the hand pulse sensors, or wearing a heart rate chest belt transmitter, will start the Heart Icon blinking (this may take a few seconds). **The Message Window** will display your heart rate, or Pulse, in beats per minute. The Bar Graph represents the percentage of your maximum heart rate you are currently achieving. NOTE: You must enter your age during program setup for the Bar Graph to be accurate. Refer to Heart Rate section for details about these features and how they can help you work out more efficiently.

The **Stop/Reset** button actually has several functions. Pressing the **Stop/Reset** key once during a program will pause the program for 5 minutes (when you stop pedaling without AC power the display will turn off but the memory will be saved for 5 minutes just like the pause mode). If you need to get a drink, answer the phone, or any of the many things that could interrupt your workout, this is a great feature. To resume your workout during Pause just press the **Start** key or start pedaling. If the **Stop/Reset** button is pressed twice during a workout the program will end and the console will return to the start up screen. If the **Stop/Reset** key is held down for 3 seconds the console will perform a complete Reset. During data entry for a program the Stop/Reset key performs a Previous Screen function. This allows you to go back one step in the programming each time you press the **Stop/Reset** key.

The Program Keys are used to preview each program. When you first turn the console on you may press each program key to preview what the program profile looks like. If you decide that you want to try a

program, press the corresponding program key and then press the Enter key to select the program and enter into the data-setup mode.

The program keys also act as a Number Key Pad when you are in the data-setup mode. Under each program key is a number. If you are setting new data such as age, weight etc., you can use these keys to enter the numbers quickly.

The console includes a built-in fan to help keep you cool. To turn the fan on press the key on the right side, front of the console.

PROGRAMMABLE FEATURES

Each of the programs can be customized with your personal information and changed to suit your needs. Some of the information asked for is necessary to ensure the readouts are correct. You will be asked for your **Age** and **Weight**. Entering your **Age** ensures that the Heart Rate bar graph shows the correct number. Your **Age** is also necessary during the Heart Rate control program to ensure the correct settings are in the program for your **Age**. Otherwise the work settings could be too high or low for you; entering your **Weight** aides in calculating a more correct Calorie reading. Although we cannot provide an exact calorie count we do want to be as close as possible.

CALORIE NOTE: Calorie readings on every piece of exercise equipment, whether it is in a gym or at home, are not accurate and tend to vary widely. They are meant only as a guide to monitor your progress from workout to workout. The only way to measure your calorie burn accurately is in a clinical setting connected to a host of machines. This is because every person is different and burns calories at a different rate. Some good news is that you will continue to burn calories at an accelerated rate for at least an hour after you have finished exercising!

ENTERING A PROGRAM & CHANGING SETTINGS

When you enter a program (by pressing a program key, then **Enter** key) you have the option of entering your own personal settings. If you want to workout without entering new settings then just press the **Start** key. This will bypass the programming of data and take you directly to the start of your workout. If you want to change the personal settings then just follow the instructions in the **Message Window**. If you start a program without changing the settings the default - or pre-saved – settings will be used.

MANUAL

The Manual program works as the name implies, manually. This means that you control the workload yourself and not the computer. To start the Manual program follow the instructions below or just press the Manual button then the Enter button and follow the directions in the Message Window.

1. Press the Manual key then press the Enter key.
2. The Message Window will ask you to enter your Age. You may enter your Age, using the Up and Down keys or the numeric key pad, then press the Enter key to accept the new number and proceed on to the next screen.
3. You are now asked to enter your Weight. You may adjust the Weight number using the Up and Down keys, or the numeric key pad, then press enter to continue.
4. The next setting is Time. You may adjust the Time and press enter to continue.
5. Now you are finished editing the settings and can begin your workout by pressing the Start key. You can also go back and modify your settings by pressing the Enter key.
NOTE: At any time during the editing of data you can press the Stop key to go back one level, or screen.
6. The program automatically starts you at level one. This is the easiest level and it is a good idea to stay at level one for a while to warm up. If you want to increase the work load at any time press the Up key; the Down key will decrease the workload.
7. During the Manual program you will be able to scroll through the data in the Message Window by pressing the adjacent Display key. You may also switch between the profile display and a quarter mile track by pressing the Display key adjacent to the dot matrix display.
8. When the program ends you may press Start to begin the same program again or Stop to exit the program, or you can save the program you just completed as a custom program by pressing the Custom key and following the instructions in the Message Window.

PRESET PROGRAMS

The fitness bike has five different programs that have been designed for a variety of workouts. These five programs have factory preset work level profiles for achieving different goals.

HILL

This program follows a triangle or pyramid type of gradual progression from approximately 10% of maximum effort (the level that you chose before starting this program) up to a maximum effort which lasts for 10% of the total workout time, then a gradual regression of resistance back to approximately 10% of maximum effort.

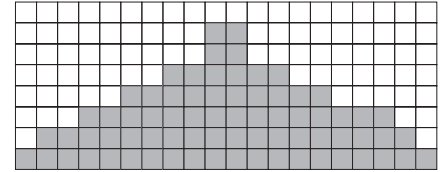

FAT BURN

This program follows a quick progression up to the maximum resistance level (default or user input level) that is sustained for 2/3 of the workout. This program will challenge your ability to sustain your energy output for an extended period of time.

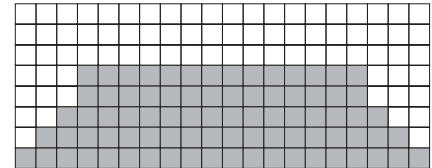

CARDIO

This program presents a quick progression up to near maximum resistance level (default or user input level). It has slight fluctuations up and down to allow your heart rate to elevate, and then recover repeatedly, before beginning a quick cool down. This will build up your heart muscle and increase blood flow and lung capacity.

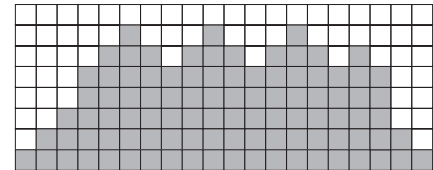

STRENGTH

Resistance: This program has a gradual progression of resistance up to 100% of maximum effort that is sustained for 25% of workout duration. This will help build strength and muscular endurance in the lower body and glutes. A brief cool down follows.

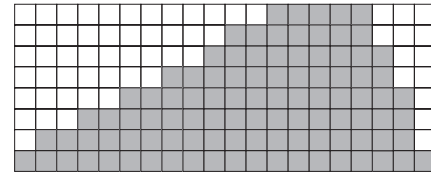

INTERVAL

This program takes you through high levels of intensity followed by recovery periods of low intensity. This program utilizes and develops your "Fast Twitch" muscle fibers which are used when performing tasks that are intense and short in duration. These deplete your oxygen level and spike your heart rate, followed by periods of recovery and heart rate drop to replenish oxygen. Your cardiovascular system gets programmed to use oxygen more efficiently.

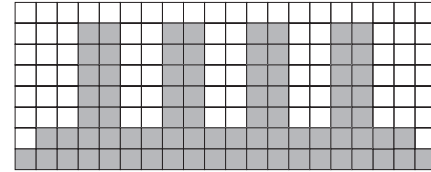

PROGRAMMING PRESET PROGRAMS

1. Select the desired program button then press the **Enter** key.
2. The **Message Window** will ask you to enter your **Age**. You may adjust the age setting, using the **Up** and **Down** keys, then press the **Enter** key to accept the new number and proceed on to the next screen.
3. You are now asked to enter your **Weight**. You may adjust the weight number using the **Up** and **Down** keys, then press **Enter** to continue.
4. Next is **Time**. You may adjust the **Time** and press **Enter** to continue.
5. Now you are asked to adjust the **Max Level**. This is the peak exertion level you will experience during the

- program (at the top of the hill). Adjust the level and then press **Enter**.
- Now you are finished editing the settings and can begin your workout by pressing the **Start** key. You can also go back and modify your settings by pressing the **Stop** key to go back one level, or screen.
 - If you want to increase or decrease the workload at any time during the program press the **Up** or **Down** key. This will change the workload settings of the entire profile, although the profile picture on the screen will not change. The reason for this is so that you can see the entire profile at all times. If the profile picture is changed it will look distorted and not a true representation of the actual profile. When you make a change to the workload, the **Message Window** will show the current column, and program maximum, levels of work.
 - During the program you will be able to scroll through the data in the **Message Window** by pressing the **Display** key next to the **Message Window**.
 - When the program ends the **Message Window** will show a summary of your workout. The summary will be displayed for a short time then the console will return to the start-up display.

CUSTOM USER DEFINED PROGRAMS

The Custom Program allows you to build and save a custom program. You can build your own custom program by following the instructions below or you can save any other preset program you complete as a custom program. The Custom Program allows you to further personalize it by adding your facility name.

- Press the **Custom** key. The **Message Window** will show a welcome message; if you had previously saved a program the message will contain the name you gave it. Then press the **Enter** key to begin programming.
- When you press **Enter**, the **Message Window** will show "Name – A", if there is no name saved. If the name "Custom Workout" had been previously saved the **Message Window** will show "Name – Custom Workout" and the C in Custom will be blinking. If there is a name saved you can change it or you may press the Stop key to keep the name and continue to the next step. If you want to enter a name use the **Up** and/or the **Down** key to change the first letter then press **Enter** to save the first letter and continue to the next letter. When you have finished entering the name press the **Stop** key to save the name and continue to the next step.

3. The **Message Window** will ask you to enter your **Age**. You may enter your **Age**, using the **Up** and **Down** keys or the numeric key pad, then press the **Enter** key to accept the new number and proceed on to the next screen.
4. You are now asked to enter your **Weight**. You may adjust the **Weight** number using the **Up** and **Down** keys or the numeric key pad then press enter to continue.
5. Next is **Time**. You may adjust the **Time** and press **Enter** to continue.
6. Now you are asked to adjust the **Max Level**. This is the peak exertion level you will experience during the program. Adjust the level and then press **Enter**.
7. Now the first column will be blinking and you are asked to adjust the level for the first segment of the workout. When you finish adjusting the first segment, or if you don't want to change, then press **Enter** to continue to the next segment.
8. The next segment will show the same level as the previously adjusted segment. Repeat the same process as the last segment then press **Enter**. Continue this process until all twenty segments have been set.
9. The **Message Window** will then tell you to press **Enter** to save the program. After saving the program the **Message Window** says "New program saved" then will give you the option to start or modify the program. Pressing **Stop** will exit to the start up screen.
10. If you want to increase or decrease the workload at any time during the program press the **Up** or **Down** key. This will only affect the workload for the present position in the profile. When the profile changes to the next column it will return to the preset work level.
11. During the User 1 or User 2 program you will be able to scroll through the data in the **Message Window** by pressing the adjacent **Display** key, switch between the profile display and a quarter mile track by pressing the **Display** key adjacent to the matrix, use the heart rate monitoring features and can switch to heart rate Auto-Pilot mode. See Heart Rate section for details of this feature).

FIT-TEST PROGRAM

The fitness test is based on the YMCA protocol and is a sub-maximal test that uses pre-determined, fixed work levels that are based on your heart rate readings as the test progresses. The test will take anywhere between 6 to 15 minutes to complete, depending on your level of fitness. The test ends when your heart rate reaches 85% of maximum at any time during the test or your heart rate is between 110 bpm and 85% at the end of two consecutive stages. At the end of the test a VO2max score will be given. VO2max stands for Volume of Oxygen uptake which is a measurement of how much oxygen you need to perform a known amount of work. The YMCA protocol uses two to four, 3 minute stages of continuous exercise (see charts below). You will be asked to choose either, Male or Female at the beginning of the test. This choice determines which test parameters will be used during the test as shown in the charts below. The only cautions are that if you are a very de-conditioned Male you need to choose option Female. If you are a very conditioned female you need to choose option Male.

WORKLOAD CHART FOR MALE OR VERY FIT FEMALE:

1st Stage				300 kgm/min					
HR		< 90			90 - 105			> 105	
2nd Stage		900 kgm/min			750 kgm/min			600 kgm/min	
HR	HR <120	HR 120-135	HR >135	HR <120	HR 120-135	HR >135	HR <120	HR 120-135	HR >135
3rd stage	1350 kgm/min	1200 kgm/min	1050 kgm/min	1200 kgm/min	1050 kgm/min	900 kgm/min	1050 kgm/min	900 kgm/min	750 kgm/min

WORKLOAD CHART FOR FEMALE OR DE-CONDITIONED MALE

1st Stage			150 kgm/min	
Heart Rate	HR<80	HR: 80-90	HR: 90-100	HR>100
2nd Stage	750 kgm/min	600 kgm/min	450 kgm/min	300 kgm/min
3rd Stage	900 kgm/min	750 kgm/min	600 kgm/min	450 kgm/min
4th Stage	1050 kgm/min	900 kgm/min	700 kgm/min	600 kgm/min

FITNESS TEST PROGRAMMING

1. Press the **Fit-Test** button and press **Enter**.
2. The message window will display **Gender Male**. The word Male will be blinking. Use the **Up** and **Down** arrows if you need to change to Female, then press **Enter**. The choice of Gender determines which workload chart will be used for the test.
3. The **Message Window** will ask you to enter your **Age**. You may adjust the age setting, using the **Up** and **Down** keys then press the **Enter** key to accept the new number and proceed on to the next screen.
4. You are now asked to enter your **Weight**. You may adjust the weight number using the **Up** and **Down** keys then press **Enter** to continue.
5. Now press **Start** to begin the test or **Enter** to modify your settings.

Before The Test:

- Make sure you are in good health; check with your physician before performing any exercise if you are over the age of 35 or persons with pre-existing health conditions.
- Make sure you have warmed up and stretched before taking the test.
- Do not take in caffeine before the test.
- Hold the hand grips gently, do not tense up.

During The Test:

- The console must be receiving a steady heart rate for the test to begin. You may use the hand pulse sensors or wear a heart rate chest strap transmitter.
- You must maintain a steady 50 RPM pedal speed. If your pedal speed drops below 48 RPM or goes above 52 RPM the console will emit a steady beeping sound until you are within this range.
- You may scroll through the various data readings in the Message Window by pressing the Display button under the Message Window.
- The Message Window will always display your pedal speed on the right side to help you maintain 50RPM.
- The data shown during the test is:
 - a. Work in KGM is actually an abbreviated form of kg-m/min. which is a work measurement of kilogram-force meter/minute
 - b. Work in Watts (1 watt is equal to 6.11829727787 kg-m/min.)
 - c. HR is your actual heart rate; TGT is the target heart rate to reach to end the test.
 - d. Time is the total elapsed time of the test.

After The Test:

- Cool down for about one to three minutes.
- Take note of your score because the console will automatically return to the start-up mode after a few minutes.

What Your Score Means:

VO2MAX CHART FOR MALES AND VERY FIT FEMALES

	18-25 years old	26-35 years old	36-45 years old	46-55 years old	56-65 years old	65+ years old
excellent	>60	>56	>51	>45	>41	>37
good	52-60	49-56	43-51	39-45	36-41	33-37
above average	47-51	43-48	39-42	35-38	32-35	29-32
average	42-46	40-42	35-38	32-35	30-31	26-28
below average	37-41	35-39	31-34	29-31	26-29	22-25
poor	30-36	30-34	26-30	25-28	22-25	20-21
very poor	<30	<30	<26	<25	<22	<20

VO2MAX CHART FOR FEMALES AND DE-CONDITIONED MALES

	18-25 years old	26-35 years old	36-45 years old	46-55 years old	56-65 years old	65+ years old
excellent	56	52	45	40	37	32
good	47-56	45-52	38-45	34-40	32-37	28-32
above average	42-46	39-44	34-37	31-33	28-31	25-27
average	38-41	35-38	31-33	28-30	25-27	22-24
below average	33-37	31-34	27-30	25-27	22-24	19-22
poor	28-32	26-30	22-26	20-24	18-21	17-18
very poor	<28	<26	<22	<20	<18	<17

HEART RATE PROGRAMS

The old motto, “no pain, no gain”, is a myth that has been overpowered by the benefits of exercising comfortably. A great deal of this success has been promoted by the use of heart rate monitors. With the proper use of a heart rate monitor, many people find that their usual choice of exercise intensity was either too high or too low and exercise is much more enjoyable by maintaining their heart rate in the desired benefit range.

To determine the benefit range in which you wish to train, you must first determine your Maximum Heart Rate. This can be accomplished by using the following formula: 220 minus your age. This will give you the Maximum Heart Rate (MHR) for someone of your age. To determine the effective heart rate range for specific goals you simply calculate a percentage of your MHR. Your Heart rate training zone is 50% to 90% of your maximum heart rate. 60% of your MHR is the recommended for burning fat while 80% is recommended for strengthening the cardio vascular system. This 60% to 80% is the zone to stay in for maximum benefit.

For someone who is 40 years old their target heart rate zone is calculated:

$220 - 40 = 180$ (maximum heart rate)

$180 \times .6 = 108$ beats per minute (60% of maximum)

$180 \times .8 = 144$ beats per minute (80% of maximum)

So for a 40 year old the training zone would be 108 to 144 beats per minute.

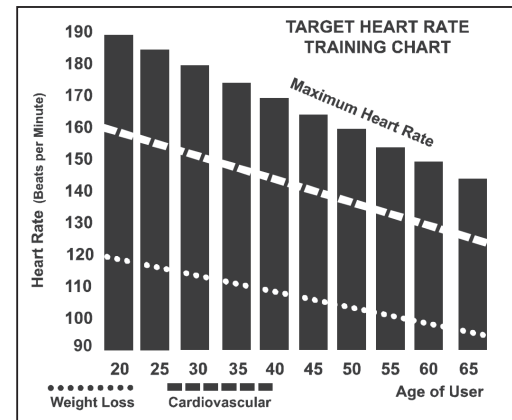

If you enter your age during programming the console will perform this calculation automatically. Entering your age is used for the Heart Rate programs. After calculating your MHR you can decide upon which goal you would like to pursue.

The two most popular reasons for, or goals, of exercise are cardiovascular fitness (training for the heart and lungs) and weight control. The black columns on the chart above represent the MHR for a person whose age is listed at the bottom of each column. The training heart rate, for either cardiovascular fitness or weight loss, is represented by two different lines that cut diagonally through the chart. A definition of the lines' goal is in the bottom left-hand corner of the chart. If your goal is cardiovascular fitness or if it is weight loss, it can be achieved by training at 80% or 60%, respectively, of your MHR on a schedule approved by your physician. Consult your physician before participating in any exercise program.

With all Spirit Fitness Heart Rate programs you may use the heart rate monitor feature without using the Heart Rate program. This function can be used during manual mode or during any of the nine different programs. The Heart Rate program automatically controls resistance at the pedals.

RATE OF PERCEIVED EXERTION

Heart rate is important but listening to your body also has a lot of advantages. There are more variables involved in how hard you should workout than just heart rate. Your stress level, physical health, emotional health, temperature, humidity, the time of day, the last time you ate and what you ate, all contribute to the intensity at which you should workout. If you listen to your body, it will tell you all of these things.

The rate of perceived exertion (RPE), also know as the Borg scale, was developed by Swedish physiologist G.A.V. Borg. This scale rates exercise intensity from 6 to 20 depending upon how you feel or the perception of your effort. The scale is as follows:

Rating Perception of Effort

6 Minimal	10 Very light +	14 Somewhat hard +	18 Very hard +
7 Very,very light	11 Fairly light	15 Hard	19 Very,very hard
8 Very,very light +	12 Comfortable	16 Hard +	20 Maximal
9 Very light	13 Somewhat hard	17 Very hard	

You can get an approximate heart rate level for each rating by simply adding a zero to each rating. For example a rating of 12 will result in an approximate heart rate of 120 beats per minute. Your RPE will vary depending up the factors discussed earlier. That is the major benefit of this type of training. If your body is strong and rested, you will feel strong and your pace will feel easier. When your body is in this condition, you are able to train harder and the RPE will support this. If you are feeling tired and sluggish, it is because your body needs a break. In this condition, your pace will feel harder. Again, this will show up in your RPE and you will train at the proper level for that day.

WEARING THE CHEST STRAP

1. Attach the transmitter to the elastic strap using the interlocking key.
2. Adjust the strap as tightly as possible as long as the strap is not too tight to remain comfortable.
3. Position the transmitter with the logo centered in the middle of your torso facing away from your chest (some people must position the transmitter slightly left of center). Attach the final end of the elastic strap by inserting the round end and, using the locking parts, secure the transmitter and strap around your chest.
4. Position the transmitter directly below the pectoral muscles.
5. Sweat is the best conductor to measure very minute heart beat electrical signals. However, plain water can also be used to pre-wet the electrodes (2 ribbed oval areas on the reverse side of the belt and both sides of the transmitter). It's also recommended that you wear the transmitter strap a few minutes before your work out. Some users, because of body chemistry, have a more difficult time in achieving a strong, steady signal at the beginning. After "warming up", this problem lessens.
6. Your workout must be within range - distance between transmitter/receiver – to achieve a strong steady signal. The length of range may vary somewhat but generally stay close enough to the console to maintain good, strong, reliable readings. Wearing the transmitter directly on bare skin assures you of proper operation. If you wish, you may wear the transmitter over a shirt. To do so, wet the areas of the shirt that the electrodes will rest upon.

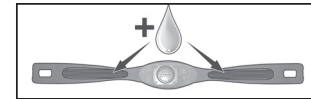
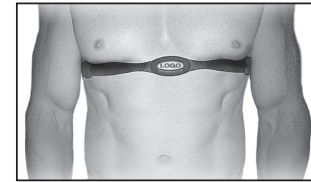

Note: The transmitter is automatically activated when it detects activity from the user's heart. Additionally, it automatically deactivates when it does not receive any activity. Although the transmitter is water resistant, moisture can have the effect of creating false signals, so you should take precautions to completely dry the transmitter after use to prolong battery life (estimated transmitter battery life is 2500 hours). The replacement battery is Panasonic CR2032.

ERRATIC OPERATION

Caution! Do not use this fitness bike for Heart Rate programs unless a steady, solid Actual Heart Rate value is being displayed. High, wild, random numbers being displayed indicate a problem.

Areas to look for interference which may cause erratic heart rate:

1. Microwave ovens, TV's, small appliances, etc.
2. Fluorescent lights.
3. Some household security systems.
4. Perimeter fence for a pet.
5. Some people have problems with the transmitter picking up a signal from their skin. If you have problems try wearing the transmitter upside down. Normally the transmitter will be oriented so the Spirit Fitness logo is right side up.
6. The antenna that picks up your heart rate is very sensitive. If there is an outside noise source, turning the whole machine 90 degrees may de-tune the interference.
7. Another Individual wearing a transmitter within 3' of your machine's console.

If you continue to experience problems contact your dealer.

HEART RATE PROGRAM OPERATION

To start the HR program follow the instructions below or just press the HR key then the Enter button and follow the directions in the Message Window.

1. Press the **HR** key then press the **Enter** key.
2. The message window will ask you to enter your Age. You may enter your Age, using the **Up/Down** keys or the numeric key pad, then press the **Enter** key to accept the new number and proceed on to the next screen.
3. You are now asked to enter your Weight. You may adjust the Weight number using the **Up/Down** keys or the numeric key pad, then press **Enter** to continue.

4. Next is Time. You may adjust the Time and press **Enter** to continue.
5. Now you are asked to adjust your target Heart Rate. This is the heart rate level you will try to maintain during the program. Adjust the value and then press **Enter**.
6. Now you are finished editing the settings and can begin your workout by pressing the **Start** key. You can also go back and modify your settings by pressing the **Enter** key. *Note: At any time during the editing of data you can press the **Stop** key to go back one level, or screen.*
7. If you want to increase or decrease the resistance at any time during the program press the **Up/Down** key. This will allow you to change your target heart rate at any time during the program.
8. The program will automatically increase or decrease the amount of resistance, depending on whether your heart rate is above or below your target.
9. During the HR program you will be able to scroll through the data in the Message Window by pressing the adjacent **Display** key.
10. When the program ends you may press **Start** to begin the same program again or **Stop** to exit the program or you can save the program you just completed as a custom user program by pressing a **User** key and following the instructions in the Message Window.

CONSTANT POWER PROGRAM

A Watts program is a controllable constant power whose Level adjusts when the speed is changed. To start the Constant Power program follow the instructions below or just press the **Constant Power** key, then the **Enter** button and follow the directions in the Message Window.

1. Press the Constant Power key, then press the **Enter** key.
2. The Message Window will ask you to enter your Age. Input your Age, using the **Up/Down** keys or the numeric key pad, then press the **Enter** key to accept the new age and proceed on to the next screen.
3. You are now asked to enter your Weight. Adjust Weight using the **Up/Down** keys or the numeric key pad, then press **Enter** to continue.

4. Next is Time. Adjust the Time, then press **Enter** to continue.
5. Now you are asked to adjust the Target Watt Level. This is the constant power you will experience during the program. Adjust using the **Up/Down** keys, then press **Enter**.
6. Now you are finished editing the settings and can begin your workout by pressing the **Start** key. You can also go back and modify your settings by pressing the **Enter** key. *Note: At any time during the editing of data, you can press the **Stop** key to go back one level, or screen.*
7. If you want to increase or decrease the workload at any time during the program, press the **Up/Down** key. This will allow you to change your target Watt level at any time during the program.
8. During the Constant Power program you will be able to scroll through the data in the Message Window by pressing the adjacent **Display** key.
9. When the program ends, you may press **Start** to begin the same program again or **Stop** to exit the program.

GENERAL MAINTENANCE

1. Wipe down all areas in the sweat path with a damp cloth after each workout.
2. If a squeak, thump, clicking or rough feeling develops the main cause is most likely one of two reasons:
 - a. The hardware was not sufficiently tightened during assembly. All bolts that were installed during assembly need to be tightened as much as possible. It may be necessary to use a larger wrench than the one provided if you cannot tighten the bolts sufficiently. I cannot stress this point enough; 90% of calls to the service department for noise issues can be traced to loose hardware.
 - b. The crank arm nut needs to be retightened
 - c. If squeaks or other noises persist, check that the unit is properly leveled. There are 2 leveling pads on the bottom of the rear stabilizer, use a 14mm wrench (or adjustable wrench) to adjust the levelers.

ENGINEERING MODE MENU

The console has built in maintenance/diagnostic software. The software will allow you to change the console settings from English to Metric and turn off the beeping of the speaker when a key is pressed for example. To enter the Engineering Mode Menu, press and hold down the **Start**, **Stop** and **Enter** keys. Keep holding the keys down for about 5 seconds and the Message Center will display Engineering Mode Menu. Press the **Enter** key to access the menu below:

1. Key Test (Will allow you to test all the keys to make sure they are functioning)
2. LCD Test (Tests all the display functions)
3. Functions (Press Enter to access settings and Up arrow to scroll)
 - a. Sleep Mode (Turn on to have the console power down automatically after 20 minutes of inactivity)
 - b. Pause Mode (Turn on allow 5 minutes of pause, turn off to have the console pause indefinitely)
 - c. ODO Reset (Resets the odometer)
 - d. Units (Sets the display to readout in English or Metric display measurements)
 - e. Beep (Turns off the speaker so no beeping sound is heard)
 - f. DA Test (Tests the brake resistance)
4. Security (Allows the keypad to be locked to prevent unauthorized use)

FITNESS BIKE WARRANTY - EFFECTIVE DECEMBER 23, 2015

Spirit Fitness warrants all its fitness bike parts for a period of time listed below from the date of retail sale, as determined by sale receipt, or in the absence of a sales receipt eighteen (18) months from the original factory shipping date.

Spirit Fitness' responsibilities include providing new or remanufactured parts, at Spirit Fitness' option, and technical support to our independent dealers and servicing organizations. In the absence of a dealer or service organization, these warranties will be administered by Spirit Fitness directly to a consumer. The warranty period applies to the following components:

Warranty	Frame	Electronics	Parts	Labor
Commercial	Lifetime	5 Years	5 Years	2 Year
Residential	Lifetime	10Years	10 Years	2 Year

NORMAL RESPONSIBILITIES OF THE CONSUMER

The consumer or non-dues paying facility is responsible for the items listed below:

1. The warranty registration card must be completed and returned to the address listed on the card within 10 days of the original purchase, or completed online to validate the manufacturer's limited warranty.
2. Proper use of the fitness equipment in accordance with the instructions provided in this manual
3. Proper installation in accordance with instructions provided with the fitness equipment and with all local electric codes.
4. Proper connection to a grounded power supply of sufficient voltage, replacement of blown fuses, repair of loose connections or defects in house or facility wiring.
5. Expenses for making the fitness equipment accessible for servicing, including any item that was not part of the fitness equipment at the time it was shipped from the factory.
6. Damages to the fitness equipment finish during shipping, installation or following installation.
7. Routine maintenance of this unit as specified in this manual.

EXCLUSIONS

This warranty does not cover the following:

1. CONSEQUENTIAL, COLLATERAL, OR INCIDENTAL DAMAGES SUCH AS PROPERTY DAMAGE AND INCIDENTAL EXPENSES RESULTING FROM ANY BREACH OF THIS WRITTEN OR ANY IMPLIED WARRANTY.
Note: Some states do not allow the exclusion or limitation of incidental or consequential damages, so this limitation or exclusion may not apply to you.
2. Service call reimbursement to the consumer. Service call reimbursement to the dealer that does not involve malfunction or defects in workmanship or material, for units that are beyond the warranty period, for units that are beyond the service call reimbursement period, for fitness equipment not requiring component replacement, or fitness equipment not in non-dues paying facility or household use.
3. Damages caused by services performed by persons other than authorized Spirit Fitness service companies; use of parts other than original Spirit Fitness parts; or external causes such as corrosion, discoloration of paint or plastic, alterations, modifications, abuse, misuse, accident, improper maintenance, inadequate power supply, or acts of God.
4. Products with original serial numbers that have been removed or altered.
5. Products that have been: sold, transferred, bartered, or given to a third party.
6. Products that do not have a warranty registration card on file at Spirit Fitness. Spirit Fitness reserves the right to request proof of purchase if no warranty record exists for the product.
7. THIS WARRANTY IS EXPRESSLY IN LIEU OF ALL OTHER WARRANTIES EXPRESSED OR IMPLIED, INCLUDING THE WARRANTIES OF MERCHANTABILITY AND/OR FITNESS FOR A PARTICULAR PURPOSE.
8. Product used in a dues paying facility (YMCA, Health Club, Etc.)
9. Product used in prisons and correctional facilities
10. Warranties outside of the United States may vary. Please contact your local dealer for details.

SERVICE

Keep your bill of sale. Twelve (12) months from the date on the bill of sale or eighteen (18) months from the date of factory shipping as determined by the serial number establishes the labor warranty period should service be required. If service is performed, it is in your best interest to obtain and keep all receipts. This written warranty gives you specific legal rights. You may also have other rights that vary from state to state. Service under this warranty must be obtained by following these steps, in order:

1. Contact your selling authorized Spirit Fitness dealer. OR
2. Contact your local authorized Spirit Fitness service organization.
3. If there is a question as to where to obtain service, contact our service department at (870) 935-1107.
4. Spirit Fitness' obligation under this warranty is limited to repairing or replacing, at Spirit Fitness' option, the product through one of our authorized service centers. All repairs must be preauthorized by Spirit Fitness. If the product is shipped to a service center freight charges to and from the service center will be the customer's responsibility. For replacement parts shipped while the product is under warranty, the customer will be responsible for shipping and handling charges. For in-home service, the customer will be responsible for a trip charge. There will be an additional trip charge if the customer is located over 100 miles from the nearest service center.
5. The owner is responsible for adequate packaging upon return to Spirit Fitness. Spirit Fitness is not responsible for damages in shipping. Make all freight damage claims with the appropriate freight carrier. **DO NOT SHIP ANY UNIT TO OUR FACTORY WITHOUT A RETURN AUTHORIZATION NUMBER.** All units arriving without a return authorization number will be refused.
6. For any further information, or to contact our service department by mail, send your correspondence to:

SPIRIT FITNESS, INC.
P.O. Box 2037
Jonesboro, AR 72402-2037

Product features or specifications as described or illustrated are subject to change without notice. All warranties are made by Spirit Manufacturing, Inc. This warranty applies only in the 48 contiguous United States. NOTE: This does not apply to Alaska or Hawaii.



800.258.4555
spiritservice@spiritfitness.com
www.spiritfitness.com



Spirit Fitness
3000 Nestle Road
Jonesboro, AR 72401



CU800 Owners Manual
© 2017 All Rights Reserved
Revision: 03.08.2017