

Octopus Series 800W/640W/200W LED Grow Lights

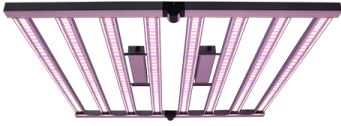

Octopus 800

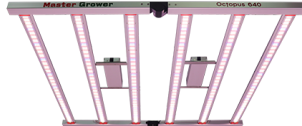

Octopus 640

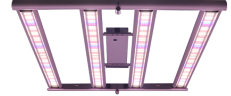

Octopus 200

1 Introduction

This manual describes the installation and connection of the product and also describes how to use the product. Mounting and installing of the Octopus Series LEDs may only be executed by certified service personnel. Please read and understand this manual completely before using the product. Only use the product as specified in this manual.

2 Product Information & Specifications

2.1 General Information

Product Name	Octopus Series LED Grow Lights			
Manufacturer	Shenzhen VANQ Technology Co., Ltd.			
Version	US	EU	UK	AUS
Plug Type	US plug 120-277V	EU plug 230V	UK plug 240V	AUS/NZS plug 240V
Input Voltage	120-277VAC	100-230VAC	100-240VAC	100-240VAC



US 5-15P

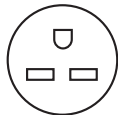

US 6-15P



US L7-15P

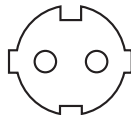

EU plug 230V













UK plug 240V



AUS/NZS
plug 240V

! **Note:** Other types of plug are also available, please check with our sales engineers directly.

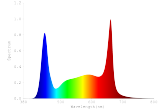
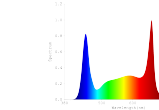
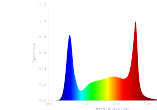
2.2 Technical specifications

		Octopus 800	Octopus 640	Octopus 200
Power				
Input Power		800W ±5%	640W ±5%	200W ±5%
Input Voltage(Standard)		100-277VAC	100-277VAC	100-277VAC
High Input Voltage(Optional)		277-480VAC	277-480VAC	—
Light Source Details				
LED Diodes - White	Model	 SMD2835	 SMD2835	 SMD2835
	Supplier	OSRAM OSRAM	OSRAM OSRAM	OSRAM OSRAM
	Rated Max Power per LED Diode	0.82W ±5% (250mA x 3.3V)	0.82W ±5% (250mA x 3.3V)	0.82W ±5% (250mA x 3.3V)
	Actual Working Power per LED Diode	0.2W ±5%	0.2W ±5%	0.2W ±5%
	LED Diodes Qty per LED Fixture	2048pcs	1536pcs	512pcs
LED Diodes - Single Color	Model	 BLUE RED SMD3030	 BLUE RED SMD3030	 BLUE RED SMD3030
	Supplier	 SANAN	 SANAN	 SANAN
	Rated Max Power per LED Diode	0.66W ±5% (300mA x 2.6V)	0.66W ±5% (300mA x 2.6V)	0.66W ±5% (300mA x 2.6V)
	Actual Working Power per LED Diode	0.28W ±5%	0.28W ±5%	0.28W ±5%
	LED Diodes Qty per LED Fixture	1408pcs	1056pcs	352pcs
Total LED Diodes Number		3456pcs	2592pcs	864pcs
Rated Max Power of all LED Diodes per LED Fixture (NOT ACTUAL POWER OF LED FIXTURE)		2608W ±5%	1956W ±5%	652W ±5%
Actual Working Power per LED Fixture / Rated Max Power of all LED Diodes per LED Fixture		31%	32%	30%
Spectrum				
Relative Radiation Intensity				
PAR (Photosynthetically Active Radiation)				
PPF(Photosynthetic Photon Flux)		2160 μmol/s	1728 μmol/s	540 μmol/s
Efficacy (100%-50% power)		2.7-2.8 μmol/J	2.7-2.8 μmol/J	2.7-2.8 μmol/J
Recommended Applications				
Indoor Vertical Farming		●	●	—
Recommended Growing Area (Indoor Vertical Farming)		4ft x 4ft 1.2m x 1.2m	4ft x 4ft 1.2m x 1.2m	—
Recommended Hanging Height From Canopy (Indoor Vertical Farming)		0.5-1.5ft 15cm-45cm	0.5-1.5ft 15cm-45cm	—
Indoor Grow Tent		◩	◩	●
Recommended Growing Area (Indoor Grow Tent)		5ft x 5ft 1.5m x 1.5m	4ft x 4ft 1.2m x 1.2m	2ft x 2ft 0.6m x 0.6m
Recommended Hanging Height From Canopy (Indoor Grow Tent)		1ft-1.5ft 30cm-45cm	1ft-1.5ft 30cm-45cm	1ft-1.5ft 30cm-45cm
Physical				
LED Fixture Weight		17 kg, 37.4 lbs	14 kg, 30.8 lbs	4.1 kg, 9.02 lbs
Dimensions		111.5cm L x 110cm W x 8.7cm D 43.9in L x 43.7in W x 3.42in D	111.5cm L x 110cm W x 8.7cm D 43.9in L x 43.7in W x 3.42in D	57.5cm L x 54.5cm W x 8.5cm D 22.64in L x 21.46in W x 3.35in D
Working Temperature		-20°C ~ 40°C -4°F ~ 104°F		
Dimming		0-10V		
IP Rating		IP43		
Certificates				
		●	●	●
		●	●	●

ORDERING CODE MATRIX FOR LIGHT FIXTURE

FAMILY	MODEL	INPUT VOLTAGE	PLUG TYPE
Octopus	800 800W	S 100-277VAC	US5 NEMA 5-15P
	640 640W	H 277-480VAC	US6 NEMA 6-15P
	200 200W	* H is only available with pigtail power cord.	USL7 NEMA L7-15P
			EU EU 230V
			UK UK 240V
			AUS AUS/NZS 240V
			P Pigtail

NOMINAL ELECTRICAL AC INPUT

Octopus 800

AC Voltage	120V	208V	230V	277V	347V	380V	400V	480V
AC Current	6.7A	3.85A	3.48A	2.89A	2.31A	2.11A	2.01A	1.67A
AC Power	804W	802W	801W	798W	800W	803W	803W	801W
Power Factor	0.98	0.98	0.98	0.98	0.98	0.98	0.97	0.97

Octopus 640

AC Voltage	120V	208V	230V	277V	347V	380V	400V	480V
AC Current	5.37A	3.08A	2.78A	2.3A	1.85A	1.7A	1.6A	1.33A
AC Power	644W	642W	641W	638W	641W	645W	642W	641W
Power Factor	0.98	0.98	0.98	0.98	0.98	0.98	0.97	0.97

* Octopus 200 is only available with 100-277VAC version.

2.3 Compatible products and accessories

Product	Product Name	Part Number
Controller	0-10V dimming controller	MG-VD100
Power cord	Power cord with US plug 5-15P, 1.5m/5ft	MG-PC-US515
	Power cord with US plug 6-15P, 1.5m/5ft	MG-PC-US615
	Power cord with US plug L7-15P, 1.5m/5ft	MG-PC-USL715
	Power cord with EU plug 230V, 1.5m/5ft	MG-PC-EU230
	Power cord with UK plug 240V, 1.5m/5ft	MG-PC-UK240
	Power cord with AUS/NZS plug 240V, 1.5m/5ft	MG-PC-AU240
Dimming cables	T-shape daisy chain connection dimming cable, 2m/6.5ft	MG-DCC-T01
Light Hanger	1/8" Adjustable Ratchet Hangers 1.8m/6ft (Set of 2 - Holds 150 lbs/100Kg)	MG-RH-01
	Steel Wire Rope Hanger 30cm/1ft (Set of 4 - Holds 150 lbs/100Kg)	MG-WR-01

2.4 Environment

The product is intended to be used in indoor growing environments. The product can be used in wet environments.

The product may not be used outdoors. The Octopus Series LEDs light functions optimal when the max ambient temperature is between 20~40°C.

2.5 Legal

CE LVD approval according to: EN 60598-2-1&EN 62471&EN 62493&EN 62778

CE EMC approval according to: EN 55015&EN 61547&EN 61000-3-2/-3

FCC

3 Packing List

Please follow the content of the list and carefully check whether the purchased equipment and accessories are complete. If you find that the actual product does not match the list, or the product is damaged, please contact us immediately and provide photos or videos!



1.LED Fixture X 1



2.1/8" Adjustable
Ratchet Hangers X 2



3.Steel Wire
Rope Hanger X 2



4.Power Cord X 1



5.Dimming Cable
(optional) X 1



6.VD-100 Controller
(optional, buy
separately) X 1

No.	Product Name	Model	Quantity
1	Octopus 800/640/200	800W/640W/200W	1
2	1/8" Adjustable Ratchet Hangers	1.8m/6ft	2
3	Steel Wire Rope Hanger	30cm/1ft	2
4	Power Cord	1.5m	1
5	Dimming Cable(optional)	T-Shape	1
6	VD100 Controller(optional, buy separately)	0-10V Dimming	1

4 Safety Precautions & Warnings

Warning!

Carefully read the warnings below before using or working with the product!

- ⚠ Always adhere to the local rules and regulations when installing or using the LED light.
- ⚠ DO NOT connect to live power until installation is complete.
- ⚠ Do not open or disassemble the LED light. Opening or modifying the LED light can be dangerous and will void the warranty.
- ⚠ Do not use the LED light when either the LED light or its power cord are damaged. Replace the power cord only with original certified cords.
- ⚠ Modifications to the cords can lead to unwanted electromagnetic effects, which makes the product not comply with legal requirements.
- ⚠ Do not expose the LED light to:
 - (ambient) temperatures outside the specified range;
 - dust and contamination;
 - direct sunlight during use or HID light that could heat up the ballast.
- ⚠ Always disconnect the LED light from mains before performing any maintenance.
- ⚠ Always allow for a cool down period of at least 30 minutes before touching the LED bars. Touching the LED bars when the light is lit or immediately afterwards can result in severe burns!
- ⚠ Do not use the LED light near flammable, explosive or reactive substances. Do not use sulfur vaporizers or water misters.
- ⚠ The installation and use of the LED light is the responsibility of the end user. Incorrect use or installation can lead to failure and damage to the LED light. Damage to the LED light and electronic circuitry as a result of incorrect installation and use revokes the warranty.

5 Installation

*All the LED fixtures in this series can be installed according to the same instructions.

Warning!

- ⚠ Mounting and installing of the LED light may only be executed by certified service personnel, in accordance with the applicable local laws and regulations.
- ⚠ The installer is responsible for correct and safe installation.
- ⚠ Ensure the local cabling can support the voltage and current requirements of the LED light.
- ⚠ Avoid coiled cords and keep mains leads separated. This prevents electromagnetic interference.
- ⚠ Do not connect or disconnect the LED light under load.
- ⚠ Mount the system to something that can hold the weight of the LED light.

5.1 Mounting the LED driver onto the light fixture

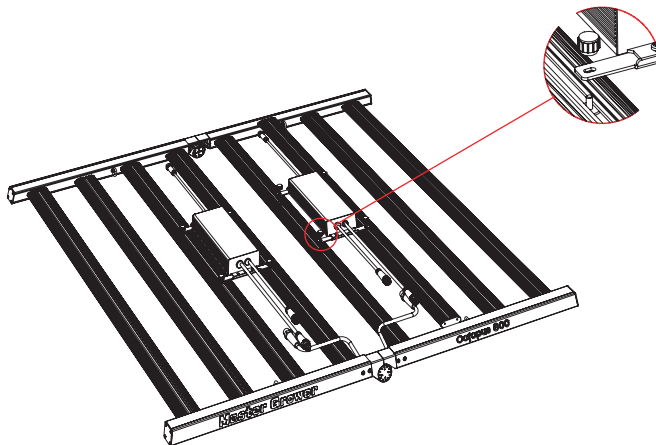

5.2 Hanging the light fixture

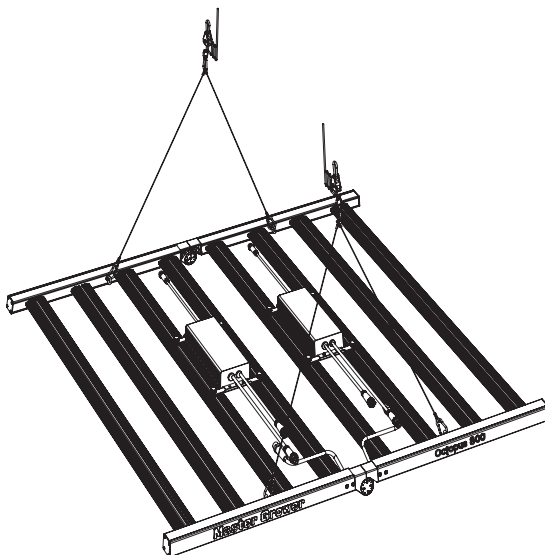

The suggested height from the plant canopy to the LED light is:

During vegetative stage, 1ft - 1.5ft/30cm - 45cm

During flowering stage, 0.6ft - 1ft/15cm - 30cm

Below is the PPFd map of 5ft x 5ft/1.5m x 1.5m at 3 different hanging heights.

Octopus 200

Hanging Height: 6" (15cm)

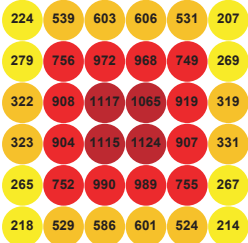

3ft/0.9m

Average PPFD of 3ft x 3ft footprint: 631 $\mu\text{mol}/\text{m}^2/\text{s}$

Octopus 640

Hanging Height: 6" (15cm)

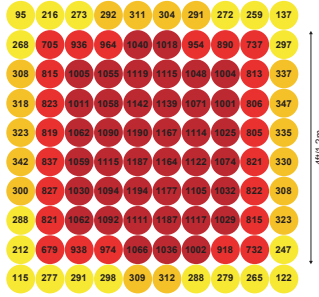

4ft/1.2m

5ft/1.5m

Average PPFD of 5ft x 5ft footprint: 736 $\mu\text{mol}/\text{m}^2/\text{s}$
Average PPFD of 4ft x 4ft footprint: 996 $\mu\text{mol}/\text{m}^2/\text{s}$

Octopus 800

Hanging Height: 6" (15cm)

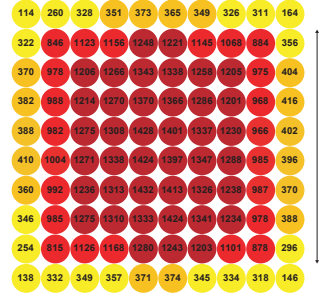

4ft/1.2m

5ft/1.5m

Average PPFD of 5ft x 5ft footprint: 884 $\mu\text{mol}/\text{m}^2/\text{s}$
Average PPFD of 4ft x 4ft footprint: 1195 $\mu\text{mol}/\text{m}^2/\text{s}$

Hanging Height: 12" (30cm)

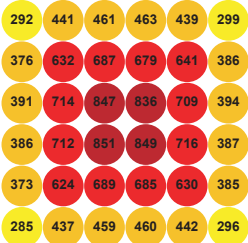

3ft/0.9m

Average PPFD of 3ft x 3ft footprint: 537 $\mu\text{mol}/\text{m}^2/\text{s}$

Hanging Height: 12" (30cm)

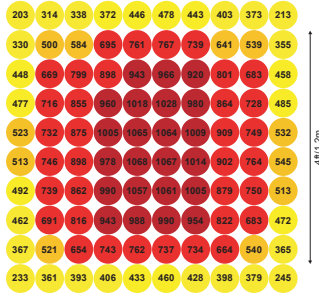

4ft/1.2m

5ft/1.5m

Average PPFD of 5ft x 5ft footprint: 681 $\mu\text{mol}/\text{m}^2/\text{s}$
Average PPFD of 4ft x 4ft footprint: 835 $\mu\text{mol}/\text{m}^2/\text{s}$

Hanging Height: 12" (30cm)

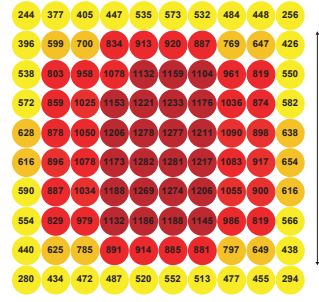

4ft/1.2m

5ft/1.5m

Average PPFD of 5ft x 5ft footprint: 817 $\mu\text{mol}/\text{m}^2/\text{s}$
Average PPFD of 4ft x 4ft footprint: 1002 $\mu\text{mol}/\text{m}^2/\text{s}$

Hanging Height: 18" (45cm)

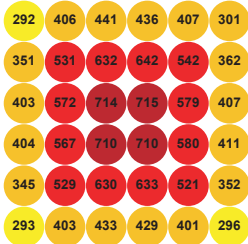

3ft/0.9m

Average PPFD of 3ft x 3ft footprint: 482 $\mu\text{mol}/\text{m}^2/\text{s}$

Hanging Height: 18" (45cm)

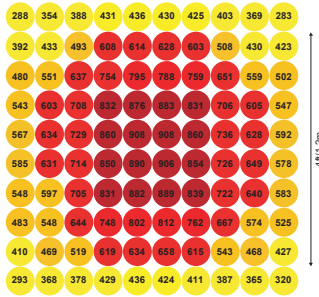

4ft/1.2m

5ft/1.5m

Average PPFD of 5ft x 5ft footprint: 603 $\mu\text{mol}/\text{m}^2/\text{s}$
Average PPFD of 4ft x 4ft footprint: 695 $\mu\text{mol}/\text{m}^2/\text{s}$

Hanging Height: 18" (45cm)

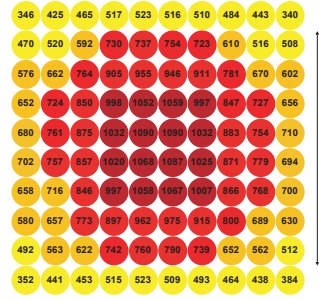

4ft/1.2m

5ft/1.5m

Average PPFD of 5ft x 5ft footprint: 724 $\mu\text{mol}/\text{m}^2/\text{s}$
Average PPFD of 4ft x 4ft footprint: 834 $\mu\text{mol}/\text{m}^2/\text{s}$

5.3 Connecting the LED light to the mains

Warning!

- ⚠ Make sure mains power is switched off.
- ⚠ Ensure the cord is not coiled and does not touch any hot surfaces.
- ⚠ Connect the cables according to local rules, safety regulations and electrical code.
- ⚠ Ensure external switching gear can cope with the inrush current of the LED fixture. Always use a double pole contactor suitable for switching a capacitive load. Never use household timers to switch the LED fixture!

6 Connecting LED Light To A Controller

Warning!

- ⚠ Do not connect or disconnect the controller with LED light under load.
- ⚠ Ensure the power cord and the controller cables do not touch any of the LED bars.

Using a daisy chain setup, a maximum of 50pcs LED lights can be connected to one controller. The controller can dim the LED light from 0 to 100%.

- Connect the dimming cable to the dimming port on the first LED light.
- Use dimming cable (T-shape) to connect the dimming port of the following LED light.
- Repeat these steps to connect up to 50pcs LED lights.

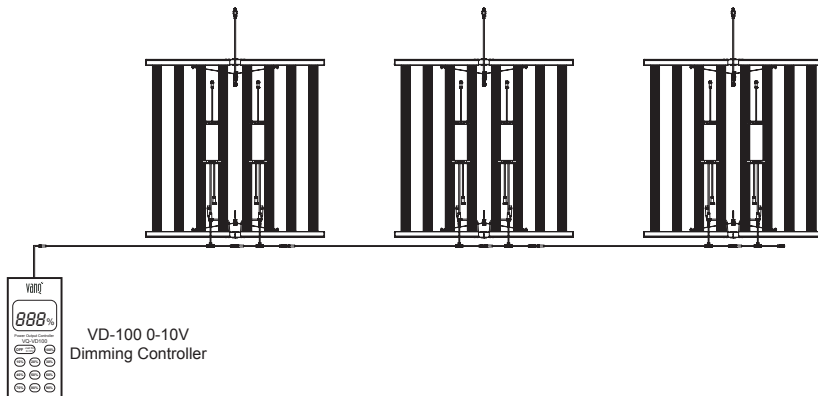

7 Inspection, maintenance and repair

- ❗ Caution! Do not clean the LED fixture with detergents, abrasives or other aggressive substances.
 - Regularly check the LED fixture for dust or dirt buildup. Clean if necessary. Contamination may cause overheating and decreased performance. Clean the outside of the LED fixture using a dry or damp cloth.
 - Regularly check the cables of the LED fixture to ensure it is undamaged.

8 Storage and disposal

- Store the LED fixture in a dry and clean environment, with an ambient temperature of -20~85° C.
- The product must not be discarded as unsorted municipal waste, but must be collected separately for the purpose of treatment, recovery and environmentally sound disposal.

9 Warranty service

VANQ technology warrants the mechanical and electronic components of their product to be free of defects in material and workmanship if used under normal operating conditions for a period of three(3) years from the original date of purchase. If the product shows any defects within this period and that defect is not due to user error or improper use, VANQ technology shall, at its discretion, either replace or repair the product using suitable new or reconditioned products or parts. In case VANQ technology decides to replace the entire product, this limited warranty shall apply to the replacement product for the remaining initial warranty period, i.e. three(3) years from the date of purchase of the original product. For service, return the LED light to your shop with the original sales receipt.

- ❗ **PLEASE NOTE:** greater than 15% of the diodes must be non-functional before the unit can be considered defective.