



# SOUND+ USER MANUAL



# DOWNLOAD THE RAD MOBILE APP

Scan the QR code with your phone to download the Rad Mobile App or go to <https://radgolf.com/pages/download-the-rad-golf-app>.

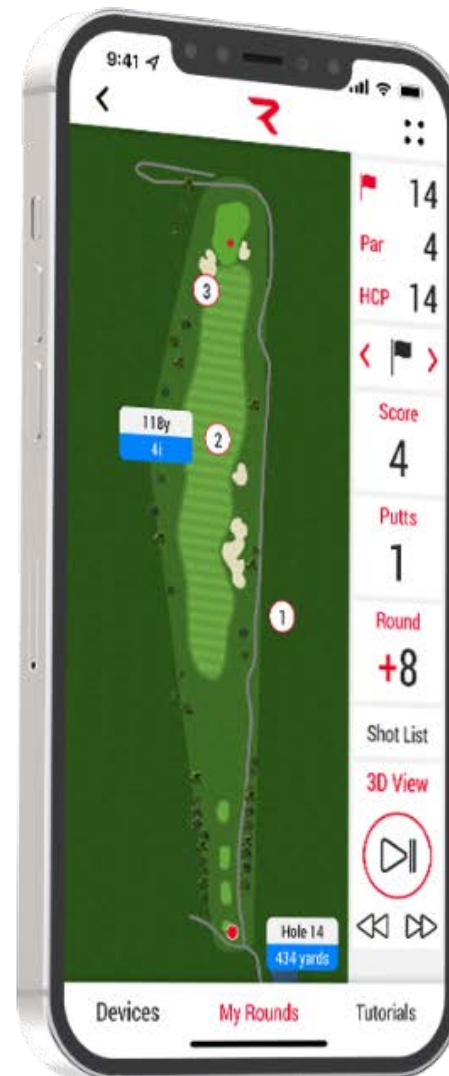
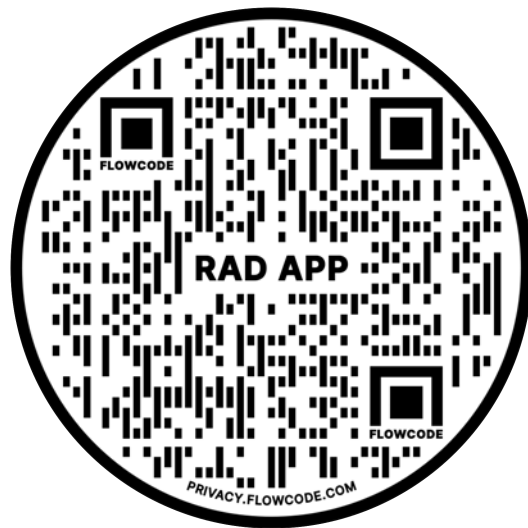

# PACKAGE CONTENTS

Please inspect the packaging carefully before attempting to use the device to ensure that the following components are present:

- 1 Sound+ Speaker
- 1 USB to USB-C Cable
- 1 User Manual QR Code Card



# DEVICE COMPONENTS

Get to know the design and the different components of your new Rad Sound+ speaker.

1. Record Score Button
2. LCD Screen
3. Volume Up
4. Volume Down
5. Power On/Off
6. LED Indicator Light
7. Charging Port & Power Bank
8. Magnet

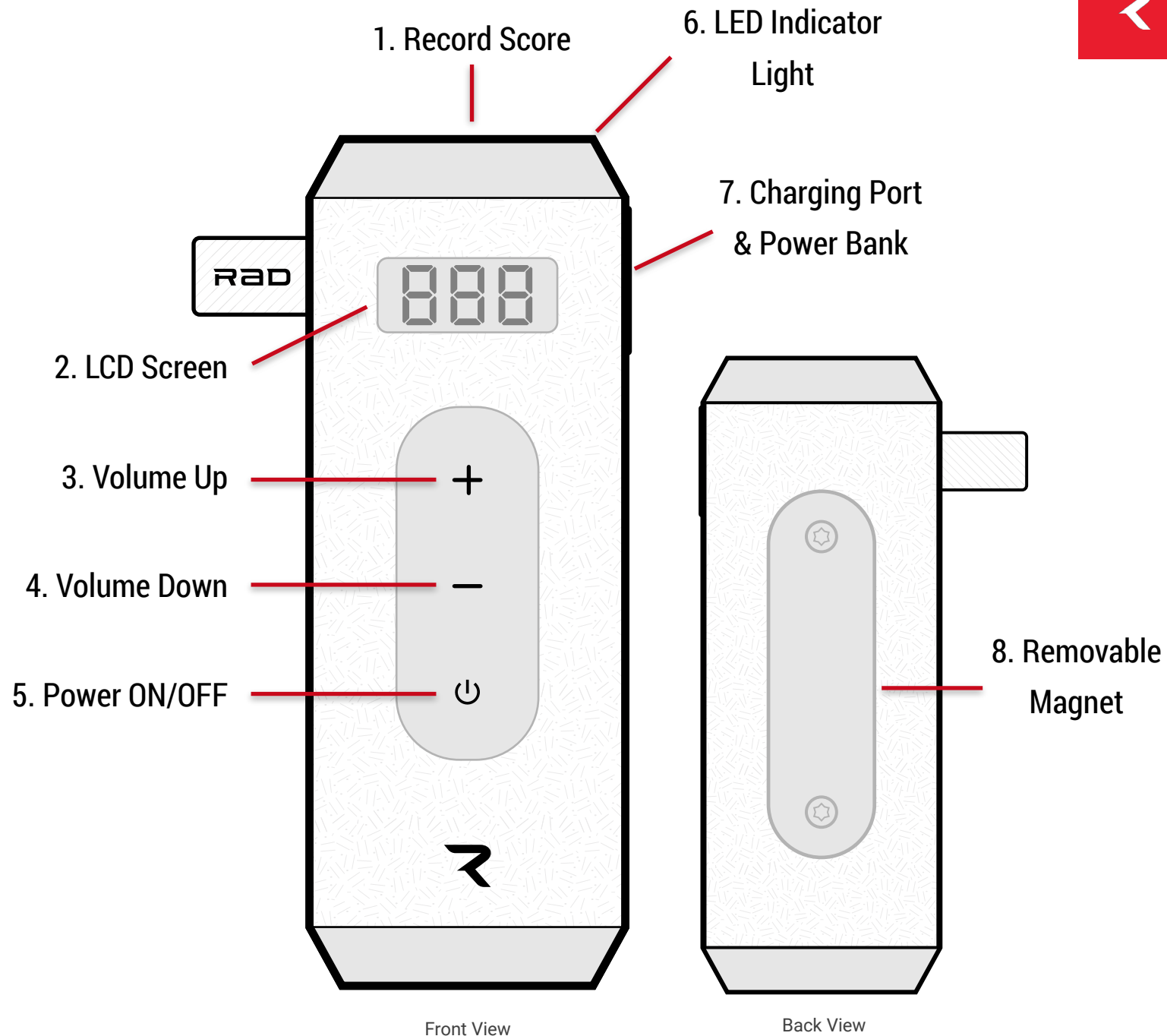

# GETTING STARTED

## CHARGING YOUR SPEAKER

- **Connect your speaker to an AC outlet before using it for the first time.**
- A red indicator light ring will turn on when the device is properly plugged in and charging.
- The Red indicator light will turn Green when charging is complete.

## POWER ON/OFF YOUR SPEAKER

- **To switch on the speaker, press and hold the Power button for 1 second.**
- The Power ON audible sound will play and the Red LED indicator light will turn on and blink to show that Bluetooth is trying to connect to a device.
- Battery level will be indicated by the LCD Screen which will display the approximate battery level.
  - \* Once you connect to the Rad App and start a round of golf, the distance to the hole will be displayed on the LCD screen instead of the battery level of the device.

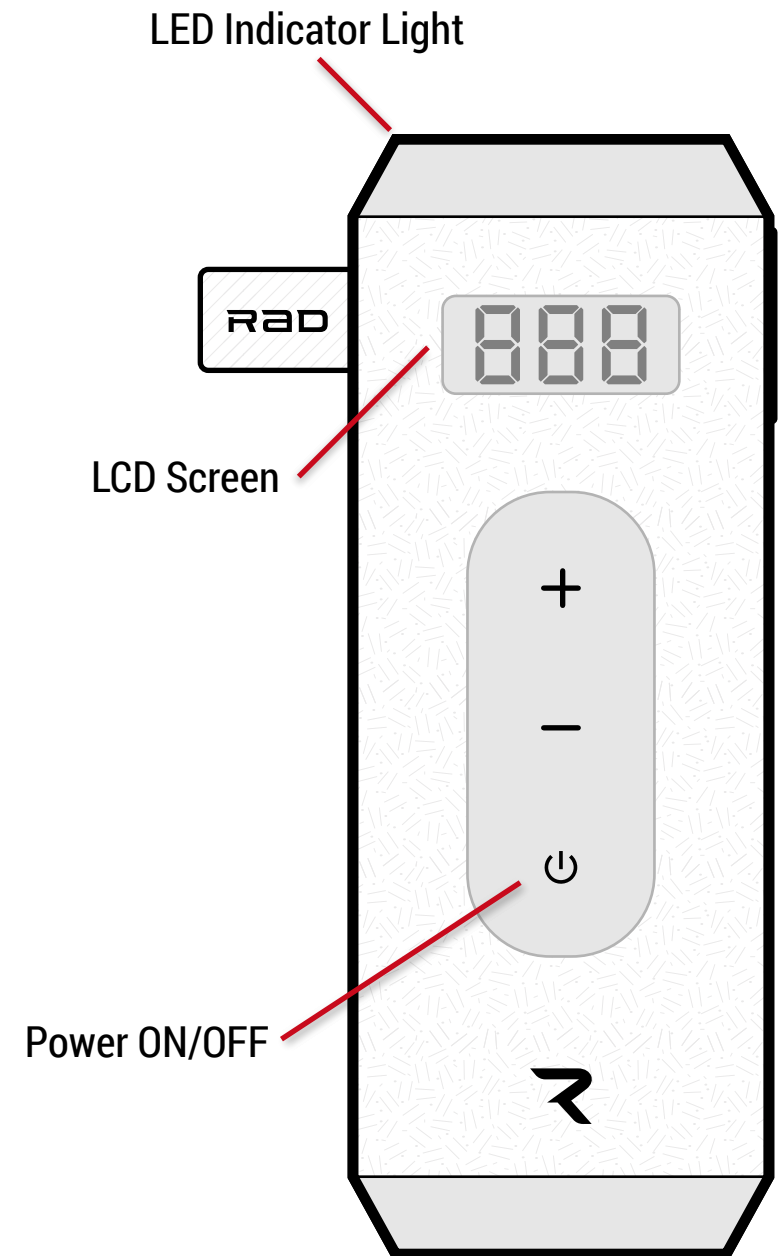

# CONNECTING SOUND DEVICE

## PAIR YOUR PHONE WITH SPEAKER

- When you power on the speaker, the Bluetooth pairing mode automatically turns on and the Blue LED lights begin to flash.
- Select the Bluetooth pairing name on the mobile phone to connect to the speaker.

## CONNECT WITH THE RAD MOBILE APP

- Login to the Rad Mobile App on your phone.
- Once you are logged in find the Sound+ device from the Home Screen and select the Register & Connect Device button.
- Follow the connection directions to finish the BLE connection.

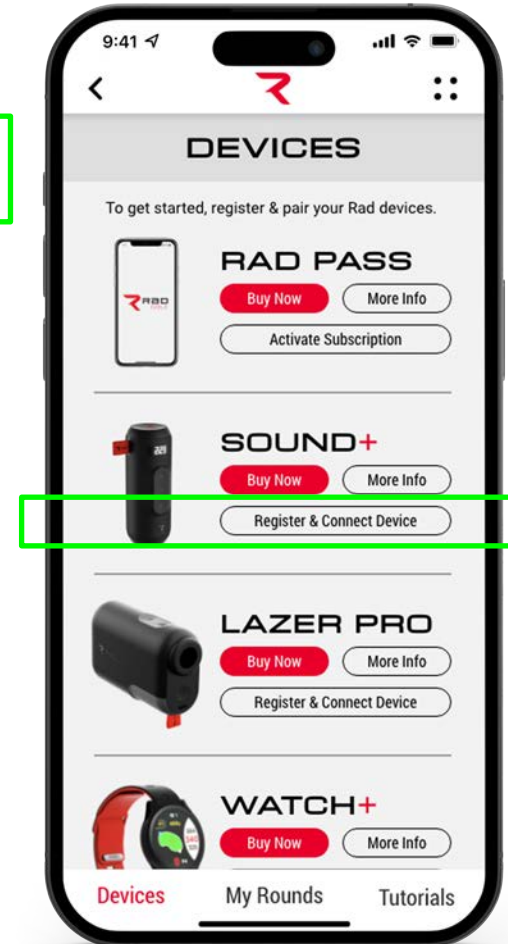
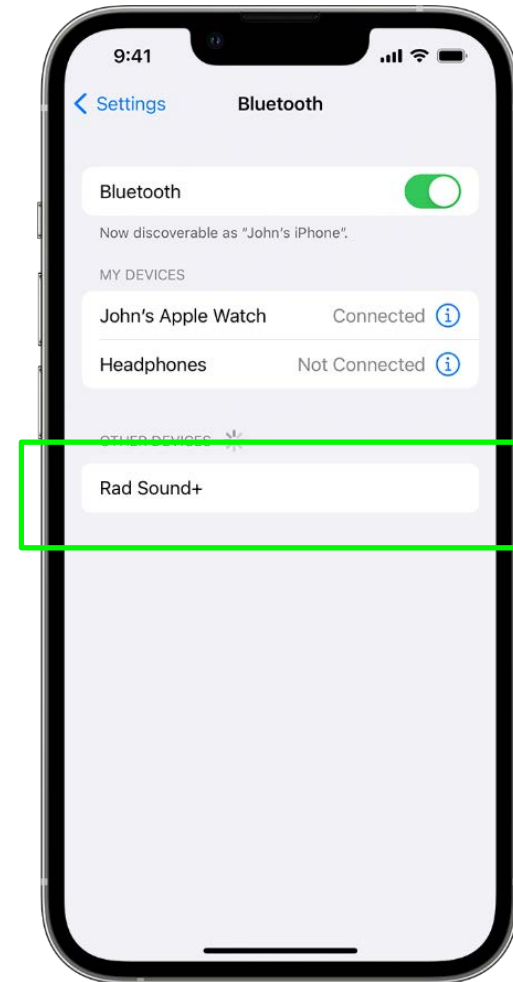

# CONNECTING TWO SPEAKERS

## TWS (PARTY MODE) PAIRING

If you have 2 Rad Sound+ speakers, then you are able to connect them to have both speakers play from the same phone device. To enable this feature follow these steps:

### 1. Power on both speakers

- The LED lights should blink to indicate both speakers are looking for a Bluetooth connection.

### 2. Double Click the Power Button on the 1st Speaker (Make sure to Press Firmly)

- You should hear an audible double chime noise.

### 3. Double Click the Power Button on the Second Speaker

- After you hear the double chime noise on the 1st speaker, then you double press the power button on the 2nd speaker.

### 4. Turn On Bluetooth on your Phone and Connect the 1st Speaker to your phone

- After you connect the 2nd speaker to the 1st speaker, then you can connect the 1st speaker to the phone by going into your bluetooth settings and selecting the 1st Rad Sound.

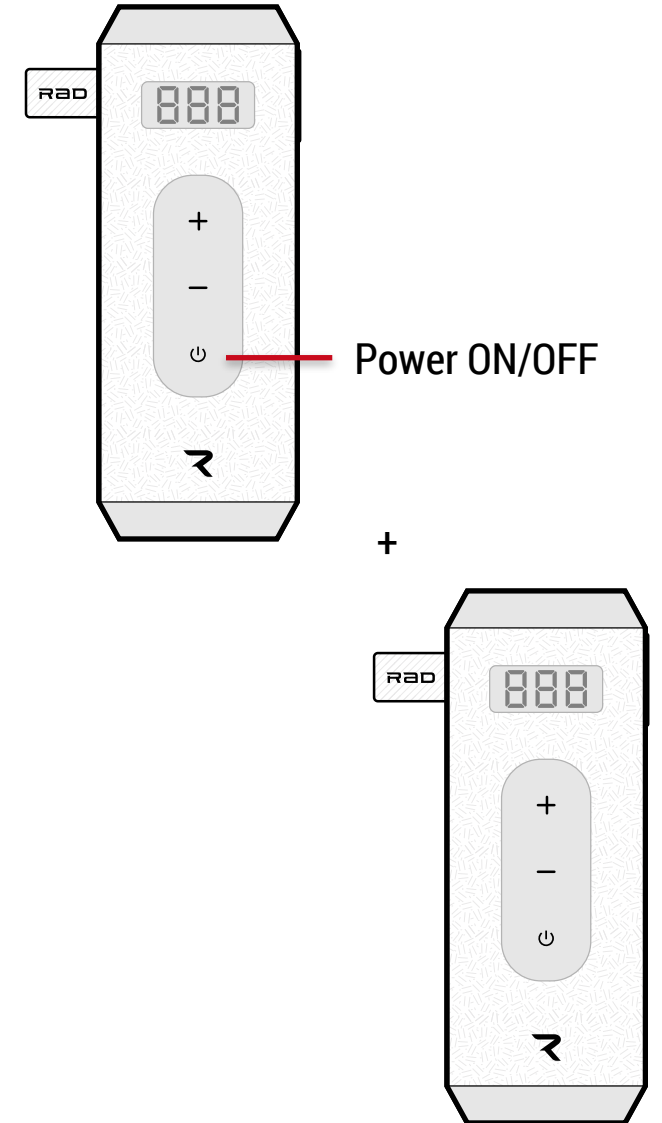

# DISCONNECT TWO SPEAKERS

## HOW TO DISCONNECT FROM TWS (PARTY MODE)

If you want to disconnect from a second Rad speaker that has been previously paired together follow these steps:

### Step 1: Double Press the Power Button

- Firmly press the Power Button twice to disable the TWS mode

### Step 2: Forget All Devices (Optional)

- If you do not want the devices to automatically pair to each other in the future, then you need to Forget All Bluetooth devices by doing a Press and Hold of both Volume Buttons while the device is powered on.

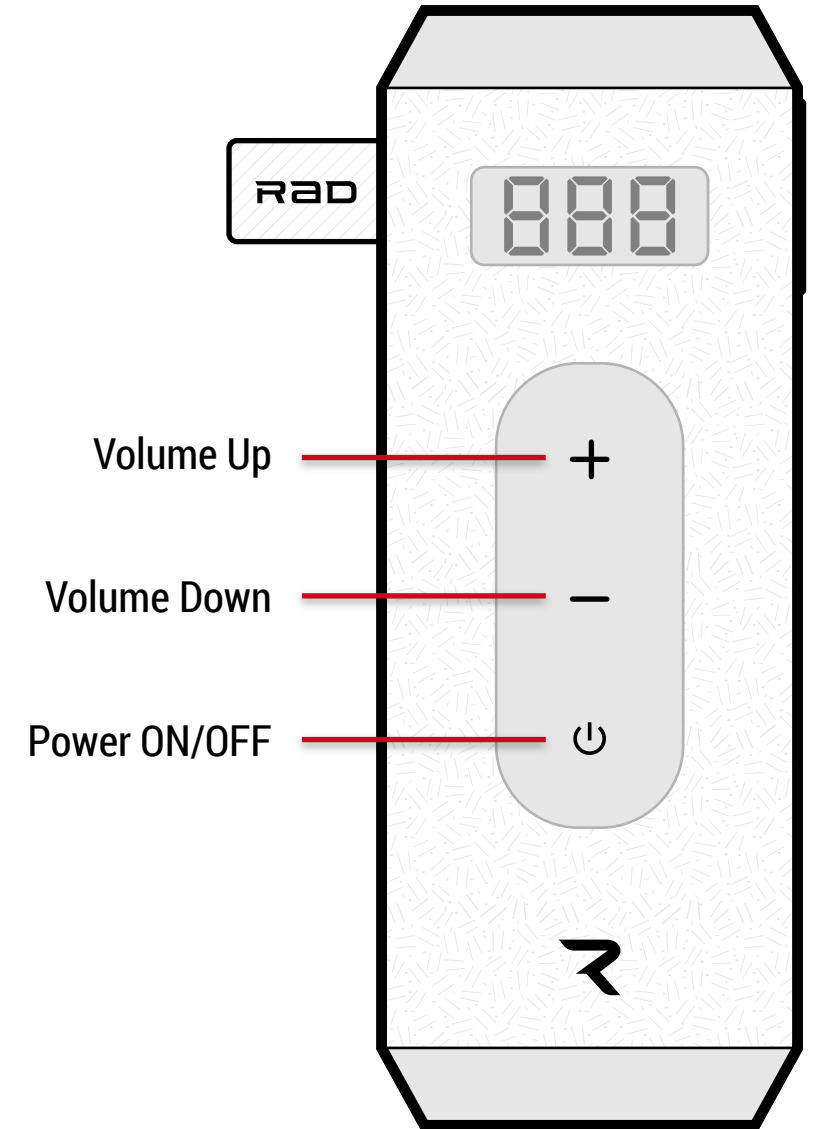



# CLEAR PAIRED BLUETOOTH DEVICES

## CLEAR THE SPEAKER PAIRING LIST

If you want to remove your Sound device from all mobile devices it has ever been connected to, then follow these steps.

- Power on the speaker and do not connect to Bluetooth.
  - Long press the Play/Pause button. Until you hear an audible announcement which says “Bluetooth Devices Cleared”.
  - All devices are cleared and your speaker is ready to pair with a new mobile device.
  - Delete your speaker from the Bluetooth list on your device.
- \* Please note that if you registered the speaker in our Rad Mobile, then you will need to **UNREGISTER THE DEVICE FROM WITHIN THE RAD MOBILE APP** if you want to transfer ownership to someone else.

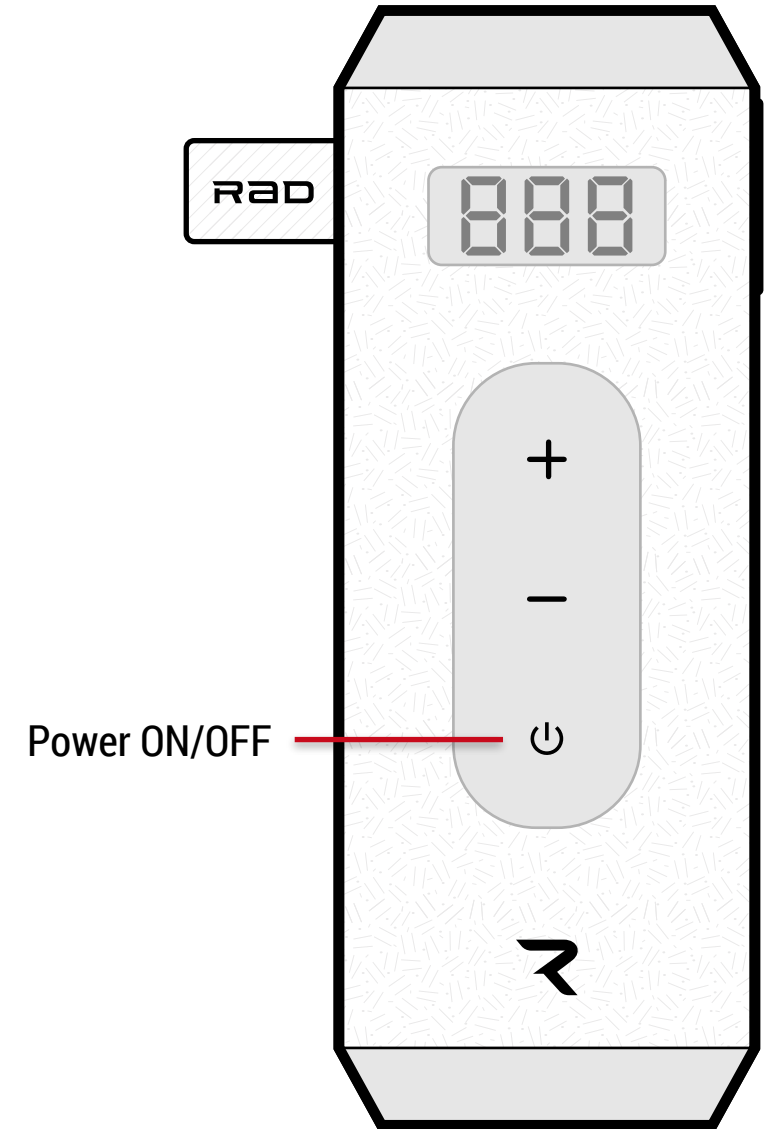

# HANDLING PHONE CALLS

## HOW TO ANSWER OR DECLINE PHONE CALLS

The Rad Sound+ has the ability to answer or decline phone calls made to the connected phone by pressing the Play/Pause button when a call comes in.

### Answer Incoming Call:

- Single press the Play/Pause button to answer an incoming call

### Decline Incoming Call:

- Press and Hold the Play/Pause button for 3 seconds to decline an incoming call

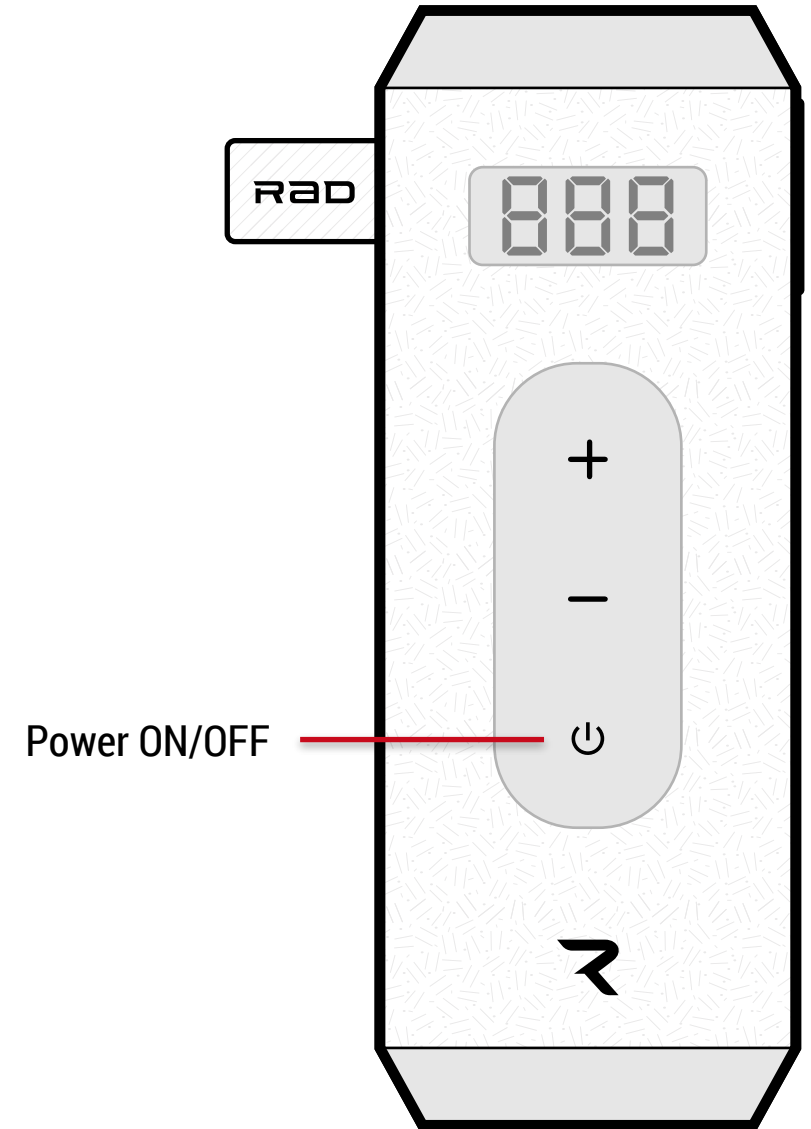

# CUSTOM TOP BUTTON

## DEFAULT FUNCTIONS FOR TOP BUTTON

The Rad Sound+ has a custom button on the top of the speaker that serves multiple functions. Users can update press options from within the Rad Mobile App.

### Single Press: Hole Distance

- Single press will announce the distance to the hole when playing a round of golf.

### Double Press: Heckle Sound

- One of the fun features of the Rad speakers is the Heckle Sound. We offer several different Heckle sound options which are set within the mobile app.

### Press and Hold: Record Score

- Press and Hold the button allows a user to record their score for a hole while playing a round of golf.
- When a user initiates the Record Score feature a voice prompt will instruct to 'Record Score After The Beep', then the user simply needs to say what their score for that hole was and it will save it in the Rad App.

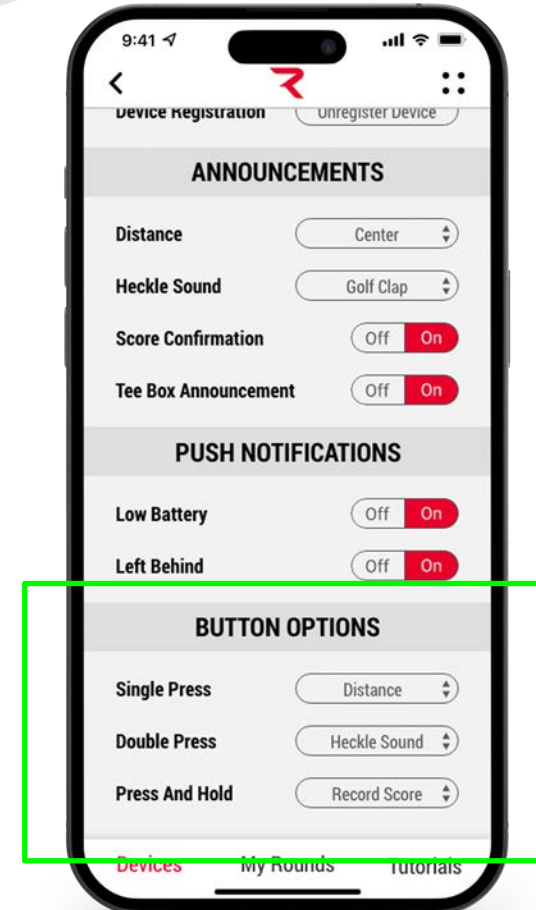
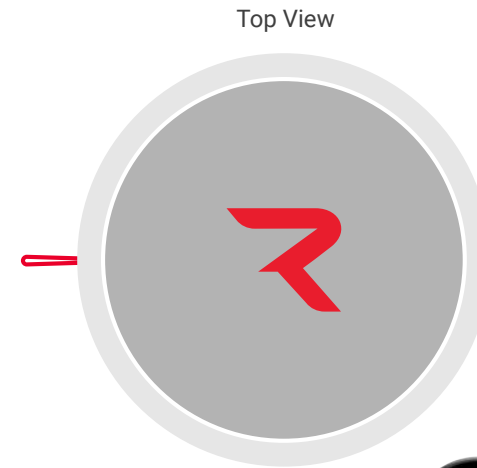

# CONTROLLING VOLUME

## HOW TO CONTROL THE VOLUME ON THE RAD SOUND

The volume on the Rad Sound+ works independently from the volume of the phone. Volume needs to be adjusted on both the device and the phone to achieve full maximum and minimum volumes.

### Increase Volume:

- Single press the Volume Up button to increase volume incrementally.
- Press and Hold to increase volume rapidly

### Decrease Volume:

- Single press the Volume Down button to decrease volume incrementally.
- Press and Hold to decrease volume rapidly

### RAD TIP:

Turn volume all the way up on the Rad Sound+ and then use the phone volume to control the overall volume.

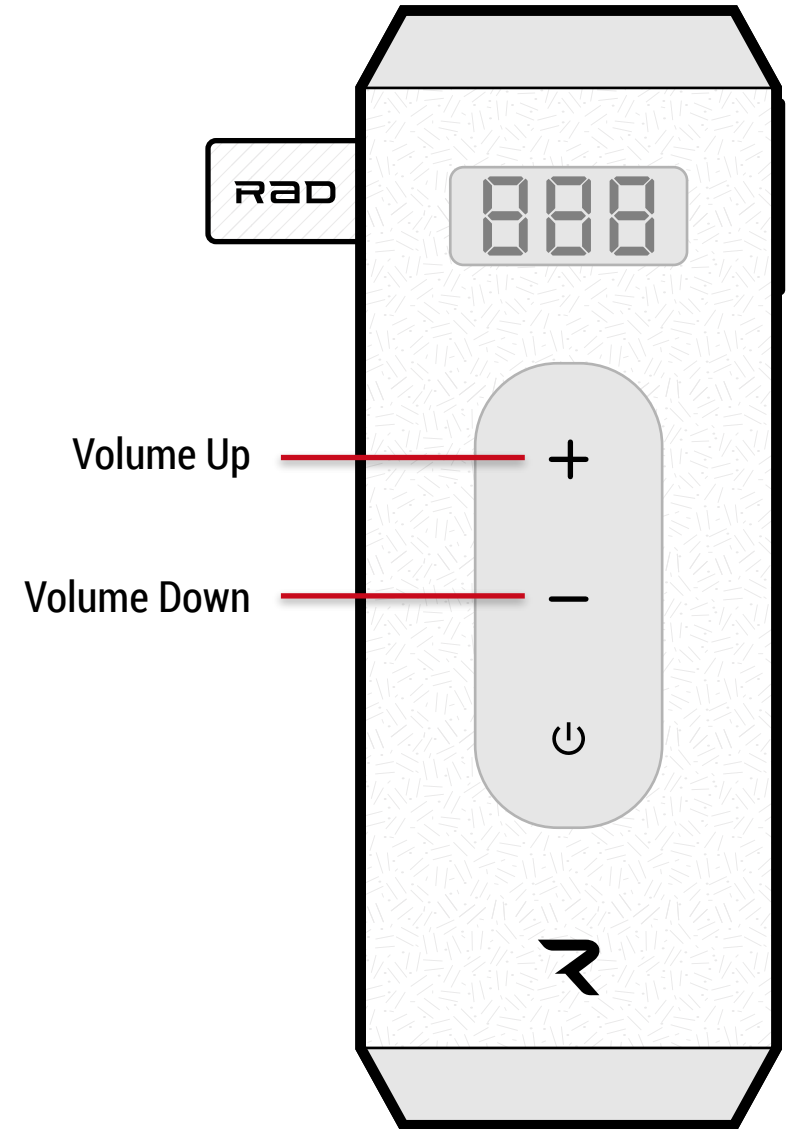



# TECHNICAL SPECS

<b>Speaker driver</b>	Size	48mm
	Quantity	2
	Impedance	4Ω±15%
	Rated power	10W x 2
	Max power	15W x 2
	Frequency response	100Hz-20KHz
<b>Battery</b>	Model	Lithium battery 18650 cell
	Nominal voltage	7.2V
	Capability	3200mAh
<b>Working time</b>	100% volume: About 2.8 hours 70% volume: About 4 hours 50% volume: About 6 hours 30% volume: About 12 hours Standby time: About 30 hours	
<b>Electric power parameter</b>	Input voltage/current	TYPE-C USB 5V/2A
	Charging time	Around 4 hours (current 1A)
	Standby current	< 120mA
	Shutdown current	< 60uA
<b>Waterproof grade</b>	IPX6	
<b>Materials</b>	ABS+Fabric cover	
<b>Product size</b>	100 x 189 x 79 mm ±0.5 mm	
<b>Product weight</b>	584g ±20g (approx. 1.3 lbs)	

<b>Bluetooth Chipset</b>	ATS2833
<b>Bluetooth version</b>	BT5.0
<b>Bluetooth pairing name</b>	Rad Sound+
<b>Support profiles</b>	HFP V1.5; A2DP V1.2; AVRCP V1.4, GAVDP V1.2; AVDTP V1.2; SPP V1.2; AVCTP V1.2
<b>Audio decoding</b>	SBC
<b>RF RF carrier frequency</b>	2402MHz-2480MHz
<b>Bluetooth working distance</b>	10 meters
<b>Output power</b>	10W
<b>Whole machine sensitivity SPL</b>	82±3dB (BT in 200mv/1m) 1K-10KHz
<b>Channel</b>	Stereo (dual channels)
<b>S/N</b>	≥73dB
<b>Frequency range</b>	80Hz – 20KHz -10dB
<b>THD</b>	≤1% at 1KHz 1M/1W
<b>Automatically turn off time (Bluetooth disconnected)</b>	10 Minutes
<b>Working temperature</b>	0~45°C
<b>Storage temperature</b>	-20~50°C



SUPPORT@RADGOLF.COM  
[WWW.RADGOLF.COM/SUPPORT](http://WWW.RADGOLF.COM/SUPPORT)

