

* | 81 kW (108 HP) @ 2200 rpm

▲ | 15100 - 15500 kg

📦 | 0.24 - 0.76 m³



DX140LCR-3 | Crawler Excavator



Doosan – Building your tomorrow today

■ Be part of the great Doosan family

The Doosan Group was founded in 1896. It is headquartered in Seoul, South Korea, and today is one of the fastest growing companies in the world:

From 1896, the first modern local store in Korea



117 years of history

20th century & beyond, major player in various industries all around the world



43100 employees in 34 countries

Today, a global leader in the Infrastructure Support Business (ISB) sector



Global presence:

- 56 subsidiaries
- 3700 distributors worldwide

AN EXPLOSIVE GROWTH RECORD
DOOSAN GROUP REVENUE

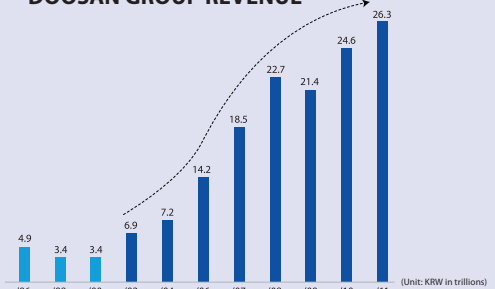

Dramatic growth over the past decade:

- 23% average annual revenue growth since 2000
- From 3.4 to 24.6 KRW trillion between 1998 and 2010



■ Doosan Group



Doosan Engine

- World N° 2 in medium speed marine diesel engines



Doosan Mecatec

- World N° 1 chemical process equipment company
- 60000 tonnes annual production capacity

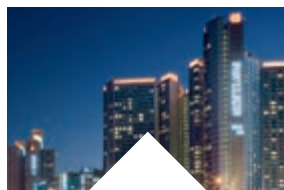

Doosan Construction & Engineering

A pioneering leader in construction of residential and public buildings, civil works and industrial facilities.



Doosan Heavy Industries & Construction

- World N° 1 in desalination plant
- World N° 1 in heat recovery steam generator market
- World N° 1 in mould & tool steel
- World N° 3 in crankshafts

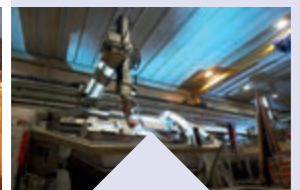

Doosan Infracore

- World N° 1 in compact loaders
- World N° 1 in attachments
- World N° 1 in portable air compressors
- N° 1 in China: 22000 excavators sold in 2010

Doosan – One-stop shop

■ From machine manufacturer... TO FULL SOLUTION PROVIDER

All Doosan Infracore Construction Equipment products are designed and built to deliver the highest levels of performance and productivity. Parts and service support are intended to fully maintain the performance, productivity and reliability expected of our products throughout their entire lifetime as well as ensure the highest trade-in and residual values.

■ Ask your dealer for a full range of services designed for you!

Your dealer is your local specialist to ensure you receive the maximum benefits from our integrated package. Think in advance, think to ensure the success of your equipment!

- ① Genuine parts
- ② Extension of warranty
- ③ Maintenance contract
- ④ Telematics
- ⑤ Monitoring systems
- ⑥ Financial solutions
- ⑦ Doosan approved attachments



Construction Equipment



Machine tools



Engines

Doosan Infracore Construction Equipment

We have been building a global production and business network since 1990 to become one of the world's foremost construction equipment manufacturers. In addition to operating large-scale factories worldwide, we have also established sales subsidiaries, branches and a dealership network all over the globe, making us a truly global player in every respect.



TAKE A TOUR

Large, heavy-duty boom and arm cylinders for smooth, powerful operation

Reliable and well protected hydraulic, electric and lubrication routings with simple, optimised layout

Reinforced forged steel pivot points

Reinforced heavy-duty arm and boom

New work lights with improved illumination (standard: 1 front frame, 4 front & 2 rear cab-mounted, 2 boom mounted and 1 rear side)

Two-piece boom available for improved working range

All-round visibility with better view through the rear and right windows

Massive maximum bucket and arm digging forces of 11.1 and 7.7 t

EXPERT CONTROL

- Joystick and switches integrated in the control stand for precise operation. All switches grouped together and ergonomically positioned to the right
- 3 working and 3 power modes for maximum efficiency
- Proportional control (flow/pressure) to operate attachments smoothly and precisely
- New, user-friendly 7" TFT LCD colour monitor with full access to machine settings and maintenance data
- Rear camera and large side mirrors
- Battery disconnect switch
- Straight travel pedal (optional)

WITNESS COMPACTNESS, ENTER THE POWER

COMFORTABLE WORKSPACE

- Spacious ROPS cab with low noise and vibration levels
- Fully adjustable heated air suspension seat as standard
- Large sun roof for extra overhead visibility
- Air conditioning
- Extra-large door for easy access

MAXIMUM EFFICIENCY

- New powerful CUMMINS "Common Rail", Stage IIIB compliant, non DPF (Diesel Particulate Filter), EGR 4 cylinder engine
- e-EPOS System (Electronic Power Optimising System) and hydraulic power boost function for optimised combustion and minimised emissions
- Efficient conversion of engine output into hydraulic performance for better fuel efficiency and lower costs
- Electronic fan clutch that reduces fuel consumption and noise level while improving cooling performance

EASY MAINTENANCE

- Easy access to all maintenance components
- Maintenance-free engine with no ash collection or removal
- Maintenance data available directly from control panel
- Fuel pre-filter with water separator
- PC access for maintenance and repairs
- Self-diagnosis function
- Reliable Doosan parts
- Battery cut-off switch

Standard additional counterweight provides superior lift capacity

SOLID STRENGTH

- Heavy-duty X-shaped undercarriage with integrated track spring and idler plus durable box section track frame
- Extra durable undercarriage (standard: 2.59 m)
- Increased drawbar pull of 12.5 t

Exclusive, passive, simplest and most reliable aftertreatment system designed without particulate filter & regeneration

DX140LCR-3

All-round versatility and improved fuel efficiency

■ Expect the best with combined performance, stability, comfort and compactness

Specifically designed for work in confined spaces, the DX140LCR-3 has an ultra short tail swing profile (1530 mm) to work in areas where conventional profile excavators would pose a safety risk. It is perfect for work in tight places and provides the top performance levels you expect from all Doosan equipment.

- Powerful and maintenance-free engine with compact catalyst delivering up to 5% more fuel economy
- Improved hydraulic system using the engine power more effectively
- Increased digging power, swing torque, lifting capacities and traction force combine for performance you can rely on day after day



6 ASSETS FOR YOUR BENEFIT!

- Power: 81 kW (108 HP) at 2200 rpm, 4 cylinder engine
- Productivity: side lifting capacity at 6 m reach and 3 m height: 2.33 t
- Excavation: max. arm digging force: 7.7 t
- Traction: max. drawbar pull: 12.5 t
- Manoeuvrability: max. swing torque: 36.7 kNm
- Size: Ideal dimensions and working range



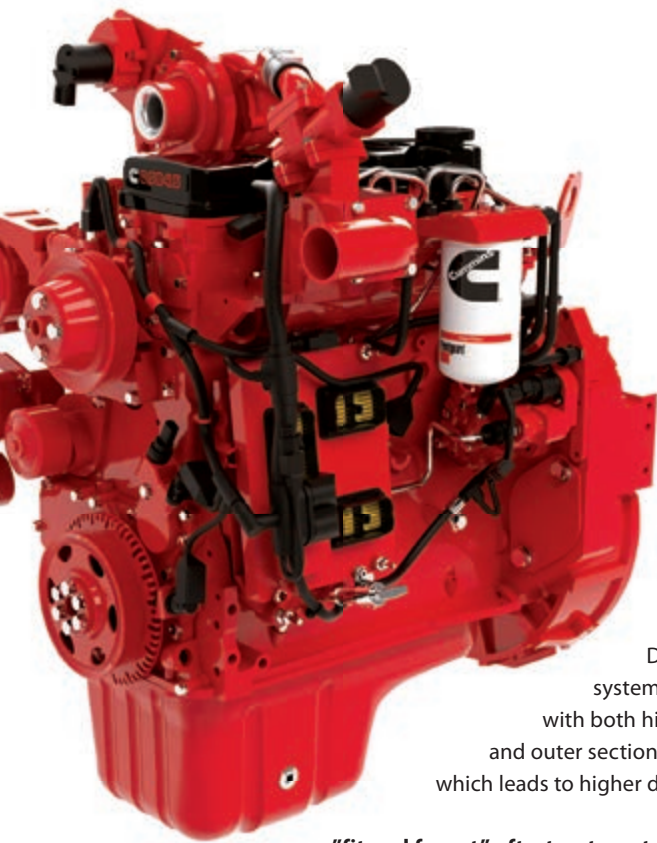

EFFICIENT MANAGEMENT OF FUEL AND HYDRAULICS WITH THE ONLY FULLY PASSIVE AFTERTREATMENT SYSTEM IN THE MARKET FOR ENGINES FROM 56-129 KW (75 HP TO 173 HP)

"Common Rail" Cummins QSB4.5 engine

The heart of the DX140LCR-3 is the "Common Rail" Cummins 4 cylinder engine, carefully designed with common rail injection and 4 valves per cylinder. The engine delivers 81 kW (110 PS / 108 HP) at only 2200 rpm. Powerful torque allows efficient use of the hydraulic system and faster working cycles.

Already known for its outstanding reliability, the Cummins QSB4.5 engine has been optimised for the DX140LCR-3 and is now compliant with the Stage IIIB European regulations using EGR (Exhaust Gas Recirculation). In combination with the e-EPOS electronic control system, it offers the ultimate in power delivery and fuel economy.

Variable Flow Turbocharger

Drives cooled EGR and improves boost compared to wastegate turbocharger system & preserves transient response and low end torque. This turbo is proven with both high reliability and a simple mechanism variable turbine with both an inner and outer section. This simple turbine allows for lower complexity and fewer moving parts, which leads to higher durability.



"fit and forget" aftertreatment system with maintenance-free catalyst

Designed to last the entire life of the engine this simplest, most reliable aftertreatment system in this competitive power band – with the lowest cost of operation, is totally passive & does not require any need of any operator interaction, no lamps, no regeneration, no burners, no diesel particulate filter. It is achieved with a catalytic coating and substrate uniquely tailored to this generation of engine. By passively oxidising PM from the exhaust stream with the simplicity of a small flow-through catalyst, Doosan, with this new Cummins engine, is able to achieve new Stage IIIB emissions levels with uncompromising engine transient response and reliability at highest load factors or in the toughest applications.



ADVANCED TECHNOLOGY FOR OPTIMUM POWER MANAGEMENT

e-EPOS system (Electronic Power Optimising System)

If the engine is the heart of the excavator, the e-EPOS is its brain. It provides a perfectly synchronised communication link between the engine's ECU (Electronic Control Unit) and the hydraulic system. A CAN (Controller Area Network) system enables a constant flow of information between the engine and hydraulic system, ensuring power is delivered exactly as needed.

Simple and efficient

- Choice between 3 power modes and 3 working modes guarantees optimum performance in all conditions
- Proportional auxiliary control for attachments
- Regulation and precise control of the flow rate required by the work group
- Self-diagnosis function allows technical problems to be resolved quickly and efficiently
- Operational memory provides a graphic display of the machine status
- Maintenance and oil change intervals can be displayed

Fuel efficiency

- Auto-idle function enables fuel saving (lowered from 1000 to 800 rpm)
- New electronic fan clutch optimises cooling for more fuel savings
- Improved Main Control Valve (MCV) performance reduces energy loss
- Additional sensor allows a more efficient selection of flow/pressure/rpm according to load requirements

Reduced tail swing radius

To facilitate use in the city and in tight locations, the tail swing radius is reduced by 30%. The smallest swing diameter is only 3355 mm.

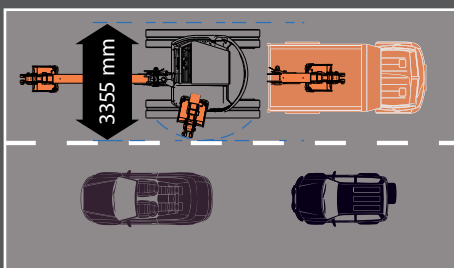

Quick and efficient

The main hydraulic pumps have an increased capacity of 2 x 114 l/min, reducing cycle times for heightened productivity. A high capacity gear pump improves pilot line efficiency.

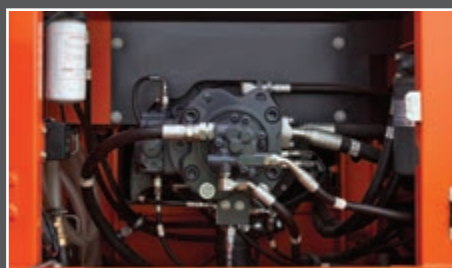

Electronic viscous fan clutch

For optimum cooling, fan speed is controlled electronically by a fan clutch, resulting in lower fan noise and better fuel efficiency.

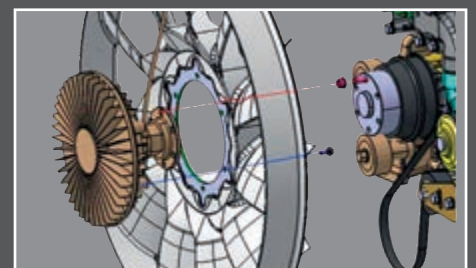

The ideal workspace – designed around you

The DX140LCR-3 is designed to provide you with the best possible working conditions. The sophisticated pressurised ROPS cab is ISO-certified for your safety. Its spacious interior offers a fully adjustable, heated air suspension seat. Comfortably seated, you have easy access to several storage compartments and a clear all-round view of the worksite. Noise and vibration levels have been reduced while air conditioning and automatic climate control allow you to maximise your productivity and return on investment.



Heated air suspension seat (standard)

As well as being adjustable and offering lumbar support, the seat has an air suspension system to reduce vibrations. It also features a button to activate the seat heating system.



Storage space and cup holder

Plenty of storage space means you can keep all your personal belongings within reach.



Air conditioning

Temperature of cab is adjusted automatically to the temperature set by operator. A recirculated air function is also available.



MP3/USB radio

MP3/USB radio with CD player optional.



ERGONOMIC OPERATOR ENVIRONMENT

Feel the comfort of a seat that fits you perfectly:

Using a dual positioning cursor, you can slide the seat back from the joysticks for the best working position. You can also slide the entire seat assembly to adjust the reach to the control pedals to your leg length.

- ① Large sun roof
- ② Sun visor
- ③ Robust ergonomic pedals
- ④ Flat, spacious, easy-to-clean floor
- ⑤ Upper front window is strut-assisted for easy, reliable adjustment and integrates a sun shade
- ⑥ Joysticks and switches are integrated in adjustable control consoles
- ⑦ Separate seat height adjustment lever and cushion tilting function
- ⑧ Storage compartment

⑤

①

②

⑥

⑧

⑦

③

④

Maximum controllability in every situation

Proportional auxiliary flow means that the excavator's huge power is matched by smooth, confident manoeuvres. Using highly sensitive joysticks and clear controls positioned for convenient access, you are able to work safely and confidently with minimum effort. Even the switches have been ergonomically placed on the right-hand control stand and positioned according to the frequency with which they are used. The highest standards of efficiency are just a finger's reach away.

Colour LCD monitor panel

The upgraded 7" TFT LCD panel features a day and night display and has been relocated within the operator's line of sight. The monitor is user-friendly and gives full access to machine settings and maintenance data. Any abnormality is clearly displayed on the screen, allowing you to work safely and confidently with an accurate overview of all conditions. All functions are totally controllable, directly via the screen or using the Jog shuttle switch.

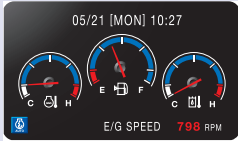

Standard screen

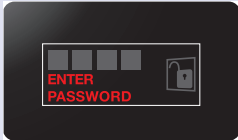

Anti-theft protection

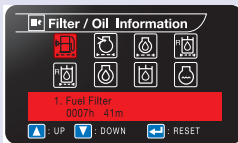

Filter/oil information

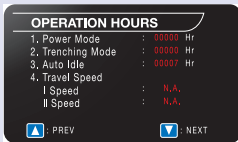

Operation history

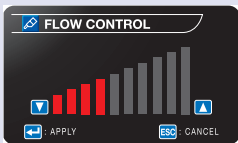

Flow rate control

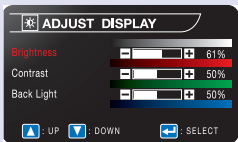

Contrast control



3 Work modes to suit your application

- 1-way mode and 2-way mode
- Digging mode

3 Power modes for maximum efficiency

- Power mode
- Standard mode
- Economy mode

Gauges

- Engine coolant and hydraulic oil temperatures
- Fuel level
- Warning symbols

Your safety – our biggest concern

- A rear view camera shows you a clear view of what's happening behind the machine.
- Cab and boom lights are fitted as standard, greatly enhancing safety on night-time jobs
- Large side mirrors improve all-round visibility (ISO compliant)

Other standard safety features include: automatic overheating prevention, low oil pressure sensor, engine emergency cut-off switch, auxiliary mode switch (to stop the pump if the control system malfunctions), overload warning device. An optional travel/swing alarm is also available.

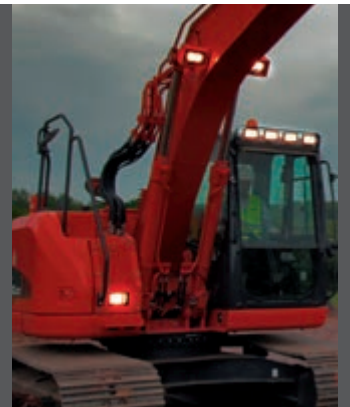

Excellent digging and lifting performance provides quick cycle times.



Dynamic power management

- Automatic travel speed function
- Activation of the power boost control system increases digging power by 10%
- A one-touch deceleration button immediately reduces engine speed to low or idle
- Auto-idling starts after 4 seconds at low rpm. This decreases fuel consumption and reduces noise levels in the cab



Simple operation

- "Short stroke" joysticks enable easy, precise control of all operations
- A thumb wheel switch and buttons on the joysticks allow proportional control of attachments such as grabs, crushers and grapples



- A straight travel pedal can be installed to facilitate operation when moving in a straight line



Quality you can rely on

■ Designed for long-term all-round heavy duty operation

In your profession, you need equipment you can depend on. At DOOSAN, we use highly specialised design and analysis tools to make sure our machines are as robust and durable as can be. Our materials and structures undergo stringent testing for strength and resilience in the most extreme conditions.

RESILIENT CHAIN FOR FIRST CLASS RELIABILITY

The DX140LCR-3 is fitted with a super-strong chain.

The 17.1 cm link pitch, 3.6 cm pin diameter and heavy-duty running gear are ideally suited for long, trouble-free service in the roughest conditions.

- Track chains: the sealed and lubricated track chains are specifically designed for better pin and bushing retention. Exclusive heat treatment gives the links a consistent surface and strong core hardness, enhancing their durability
- Track guards: two guards per track frame (standard) protect against track derailment

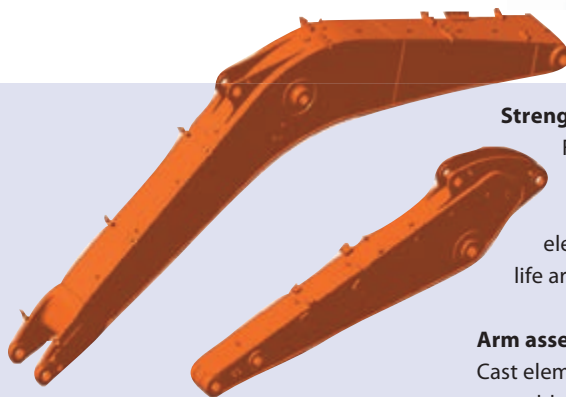

Strengthened boom

Finite Element Analysis (FEA) has been used to calculate the best load distribution throughout the boom structure. Combined with increased material thickness, this means that element fatigue is limited and both reliability and component life are increased.

Arm assembly

Cast elements and reinforcements have been added to give the arm assembly greater strength and a longer lifetime. The arm link boss and side plates have been combined for increased durability.

Protected hydraulics

The hydraulic line routing is straight and simple for a neat, compact design that enhances its durability and minimises the pressure lost.



Extra-strong X-chassis

The X-shaped undercarriage has been designed using Finite Element Analysis and 3D computer simulation to ensure optimum structural integrity and durability. The swing gear is solid and stable.



Heavy-duty sprocket

The sprocket is deep induction hardened and the depth pattern on the entire tooth profile is optimised for long-lasting service. Cast steel sprockets guarantee the highest resistance and durability even in the most severe applications. The sprocket tooth shape has been redesigned to prevent popping and increase component life.



Integrated track spring and idler

The track spring and idler have been joined together for long-lasting performance and convenient maintenance. A new seal and cylinder body rod have been used to avoid leakage. Special heat treatment ensures optimum hardness and long-lasting resistance to wear.

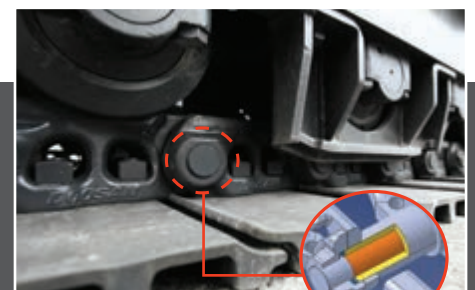

Tracks

For long-term dependability in all conditions, the chain is composed of sealed, self-lubricating links which are isolated from all external contamination. The tracks are locked by mechanically bolted pins. In areas subjected to great stress, the track link thickness has been reinforced.



The heavy-duty undercarriage provides excellent stability and durability. It is designed to excel in tough working environments.



Extra robust parallel dozer

- ❶ Large reinforced covers protect the dozer and stabilizer cylinders.
- ❷ The shape of the dozer blade is designed to facilitate pulling and mixing of materials.
- ❸ Dozer forward design, large working angle and reinforced components to ensure optimum stability when lifting or while working on sloped terrain.



Cast counterweight and steel compartment access

A cast counterweight minimises deformation resulting from external impact. Operating stability has been increased by use of a low centre of gravity design. All external compartment panels are made of steel for extra durability.

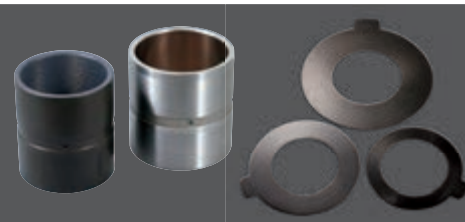

Bushing and polymer shim

A highly lubricated metal is used for the boom pivot in order to increase the component lifetime and extend the greasing intervals. A polymer shim is added to the bucket pivot to maintain precise control over the equipment and extend greasing intervals.

More value – less maintenance

Short maintenance operations at long intervals mean you can depend on your equipment being available on site when it's needed. The DX140LCR-3 is designed for simple routine maintenance, while skilled Doosan technicians are available to provide extra support when you need it. You can choose the package you need from a broad range of service agreements to get the most out of your machine. Uptime, productivity and residual value are all maximised, making these excavators an economical and rewarding choice.



Maintenance access made simple

- Large handrails are installed along with anti-slip steps and plates, for safer, easier access to the engine compartment
- A battery cut-off switch makes it easy to disconnect the battery during long-term storage or before servicing
- The hour meter display can be easily checked from ground level
- Cock valves have been fitted on the pre-filter piping line and fuel tank drain piping to make servicing easier and prevent pollution from leakage



Access to components

- Engine parts can be easily reached via the top and side panels
- Access to the various radiators and filters is very easy, making routine maintenance easier

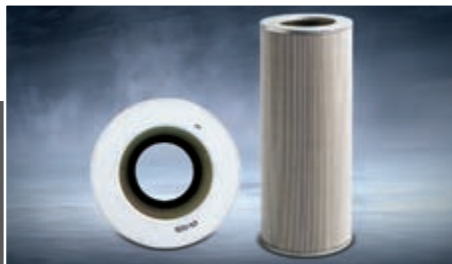
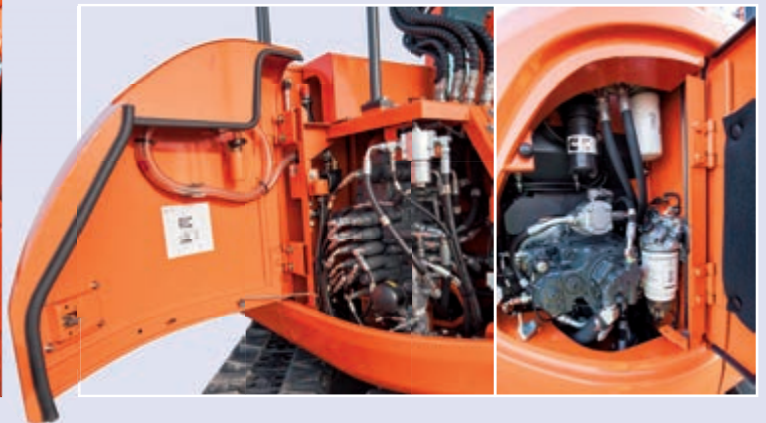

Protective oil return filter

The protection of the hydraulic system is made more effective by the use of glass fibre technology in the main oil return filter. With more than 99.5% of foreign particles filtered out, the oil change interval is extended.



Fuel pre-filter with water separator sensor

High efficiency fuel filtration is attained by the use of multiple filters. These include a fuel pre-filter fitted with a water separator that removes moisture, dirt and debris from the fuel. A warning sensor is added to each fuel filter to indicate when water draining is required.



Engine oil filter

The engine oil filter offers a high level of filtration allowing a long interval between changes. It is easy to access and is positioned to avoid contaminating the surrounding environment.

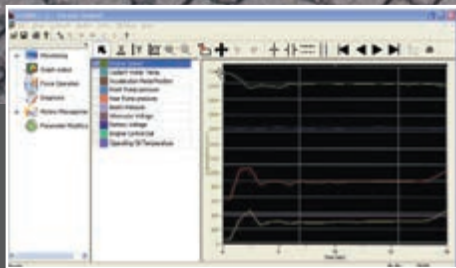

PC monitoring

A PC monitoring function enables connection to the e-EPOS system. Thus, various parameters can be checked during maintenance, including pump pressures and engine speed. This information can be saved and printed for analysis



Convenient fuse box

The fuse box is located in the storage compartment behind the seat, providing a clean environment and convenient access.



Fuel filler pump

Automatic shut-off fuel filler pump for safer and easier refuelling.



Centralised greasing points

To make maintenance easier, the greasing points have been centralised.

Technical specifications

* Engine

• Model

Cummins QSB4.5
4-Cycle Water-Cooled, Turbocharged,
Common Rail Direct Injection, Exhaust Gas Recirculation (EGR)
Cummins Compact Passive Catalyst System

• No. of cylinders

4

• Rated power at 2200 rpm

76 kW (103 PS) (DIN 6271)
81 kW (108 HP) (SAE J1995)
76 kW (102 HP) (SAE J1349)

• Max. torque at 1500 rpm

49.8 kgf/m (488 Nm)

• Idle (low - high)

800 [± 50] - 2270 [± 50] rpm

• Piston displacement

4500 cm³

• Bore x stroke

107 mm x 124 mm

• Starter

24 V / 4.5 kW

• Batteries – Alternator

2 x 12 V / 100 Ah – 24 V, 70 A

• Air filter

Double element with automatic dust evacuation.

* Hydraulic system

The brain of the excavator is the e-EPOS (Electronic Power Optimising System). It allows the efficiency of the hydraulic system to be optimised for all working conditions and minimises fuel consumption. The e-EPOS is connected to the engine's electronic control unit (ECU) via a data transfer link to harmonise the operation of the engine and hydraulics.

- The hydraulic system enables independent or combined operations
- Two travel speeds offer either increased torque or high speed
- Cross-sensing pump system for fuel savings
- Auto deceleration system
- Three operating modes, three power modes
- Button control of flow in auxiliary hydraulic circuits
- Computer-aided pump flow control

* Pumps

Pump	Type	Displacement (cm ³ /rev)	Max. flow @ 2000 rpm (l/min)	Relief valve pressure (kgf/cm ²)
Main (2)	Swash plate, Axial piston	2 x 57.9	2 x 114	-
Pilot	Gear	15	27.7	40.0

Maximum system pressure

Boom/arm/bucket	
Work/travel:	330 kg/cm ² [+10/0]
Rotation:	275 kg/cm ²
Power:	350 kg/cm ² [+10/0]

* Weight

	Shoe width (mm)	Operating weight (t)	Ground pressure (kgf/cm ²)
Triple grouser	Steel / 600 (Std)	15.3	0.39
	Steel / 500	15.1	0.46
	Steel / 700	15.5	0.34
	Rubber / 500	15.1	0.46

* Undercarriage

Very robust construction throughout. All welded structures designed to limit stresses. High-quality, durable materials. Lateral chassis welded and rigidly attached to undercarriage. Track rollers lubricated for life. Idlers and sprockets fitted with floating seals. Track shoes made of induction-hardened alloy with triple grouser. Heat-treated connecting pins. Hydraulic track adjuster with shock-absorbing tension mechanism.

• Number of rollers and track shoes per side

Upper rollers (standard shoe):	1 (ø 120 mm)
Lower rollers:	7 (ø 140 mm)
Number of links & shoes per side:	46
Overall track length:	3755

* Hydraulic cylinders

Piston rods and cylinder bodies of high-strength steel. Shock-absorbing mechanism fitted in all cylinders for shock-free operation and extended piston life.

Cylinders	Quantity	Bore x rod diameter x stroke (mm)
One-piece boom	2	110 x 75 x 1103
Arm	1	115 x 80 x 1108
Bucket	1	100 x 70 x 900
Two-piece boom	2	110 x 75 x 965
Two-piece boom, lower	1	140 x 85 x 720
Two-piece boom, upper	1	115 x 80 x 1068

* Swing mechanism

- High-torque, axial piston motor with planetary reduction gear bathed in oil
- Swing circle: single-row, shear type ball bearing with induction-hardened internal gear
- Internal gear and pinion immersed in lubricant
- Max. swing speed: 0 to 10.7 rpm
- Max. swing torque: 3740 kgf/m (Eff.=78%)

* Drive

Each track is driven by an independent, high-torque axial piston motor through a planetary reduction gearbox. Two levers / foot pedals guarantee smooth travel with counter-rotation on demand.

• Travel speed (low - high)

3.2 - 5.3 km/h

• Maximum traction (low - high)

6.8 - 12.5 t

• Maximum gradeability

35° / 70%

* Fluid capacities

• Fuel tank

220 l

• Cooling system (radiator capacity)

21 l

• Hydraulic oil tank

131 l

• Engine oil

11 l

• Swing drive

5 l

• Travel device

2 x 3 l

* Environment

Noise levels comply with environmental regulations (dynamic values).

• Noise level LwA

Guaranteed / measured: 101 dB(A) / 100 dB(A) (2000/14/EC)

• Operator LpA

72 dB(A) (ISO 6396)

* Buckets

Bucket Type	Capacity (m ³)	Width (mm)		Weight (kg)	Boom: 4600 mm Standard track: 2.59 m / rubber pads track: 2.49 m			Two-piece boom: 4987 mm Standard track: 2.59 m	
		SAE	With side cutters		Without side cutters	Arm: 2100 mm	Arm: 2500 mm	Arm: 3000 mm	Arm: 2100 mm
GP	0.24	534	464	272	A / A	A / A	A / A	A	A
	0.39	820	736	350	A / A	A / A	A / A	A	A
	0.45	911	821	384	A / A	A / A	A / A	A	A
	0.51	991	907	389	A / A	A / A	A / A	A	A
	0.59	1081	997	408	A / A	A / A	A / A	A	A
	0.64	1167	1083	431	A / A	A / A	B / B	A	B
HD	0.76	1339	1255	479	A / B	B / C	C / C	C	C
	0.42	827	762	456	A / A	A / A	A / A	A	A
	0.49	913	848	491	A / A	A / A	A / A	A	A
	0.54	981	916	511	A / A	A / A	A / A	A	A

Based on ISO 10567 and SAE J296, arm length without quick-coupler. For reference only.

A: Suitable for materials with a density less than or equal to 2100 kg/m³

B: Suitable for materials with a density less than or equal to 1800 kg/m³

C: Suitable for materials with a density less than or equal to 1500 kg/m³

D: Suitable for materials with a density less than or equal to 1200 kg/m³

* Digging forces (ISO)

		Boom: 4.6 m Arm: 2.5 m Bucket: 0.45 m ³	Boom: 4.6 m Arm: 2.1 m Bucket: 0.51 m ³	Boom: 4.6 m Arm: 3.0 m Bucket: 0.39 m ³	Two-piece boom: 4.9 m Arm: 2.5 m Bucket: 0.45 m ³	Two-piece boom: 4.9 m Arm: 2.1 m Bucket: 0.51 m ³	
		t	kN	t	kN	t	kN
BUCKET (Normal / Press. Up)	t	10.4 / 11.1	10.4 / 11.1	10.4 / 11.1	10.4 / 11.1	10.4 / 11.1	
	kN	101.9 / 108.8	101.9 / 108.8	101.9 / 108.8	101.9 / 108.8	101.9 / 108.8	
ARM (Normal / Press. Up)	t	6.2 / 6.5	7.2 / 7.7	5.6 / 6.0	7.2 / 7.7	5.6 / 6.0	
	kN	60.8 / 63.7	70.6 / 75.5	54.9 / 58.8	70.6 / 75.5	54.9 / 58.8	

Dimensions

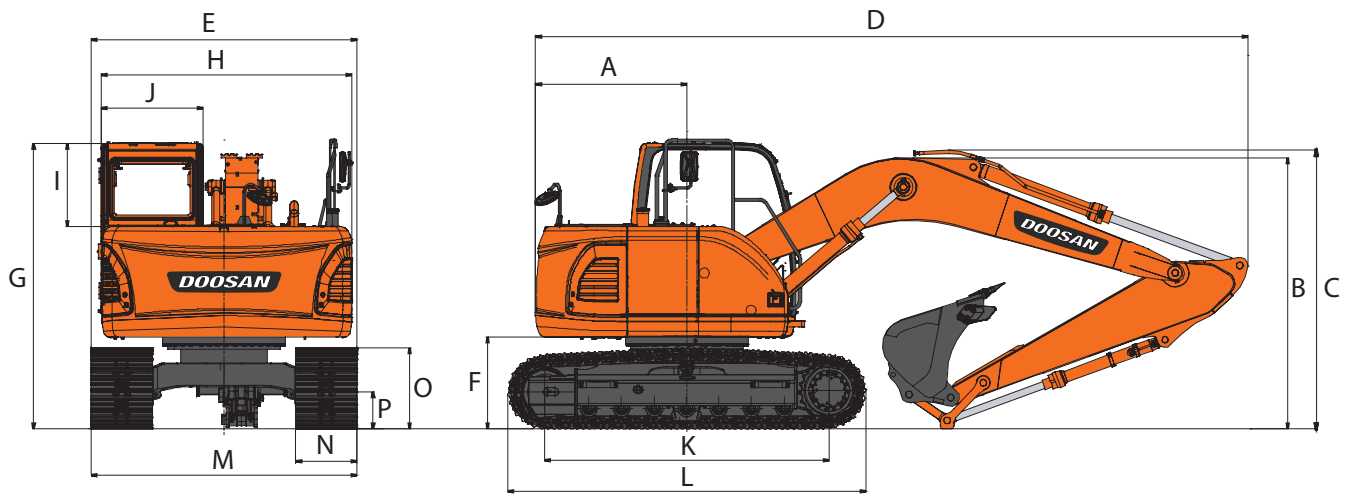

* Dimensions one-piece and two-piece boom

Boom length - mm		One-piece boom: 4600			Two-piece boom: 4987	
Arm length - mm		2100	2500	3000	2100	2500
Bucket capacity - m ³		0.51	0.45	0.39	0.51	0.45
A	Tail swing radius - mm	1530	1530	1530	1530	1530
B	Shipping height (boom) - mm	2480	2630	3030	2615	2780
C	Shipping height (hose) - mm	2595	2770	3090	2865	3030
D	Shipping length - mm	7360	7360	7320	7725	7650
E	Shipping width std. - mm	2590	2590	2590	2590	2590
F	Counterweight clearance - mm	895	895	895	895	895
G	Height over cab - mm	2795	2795	2795	2795	2795
H	House width - mm	2440	2440	2440	2440	2440
I	Cab height above house - mm	450	450	450	450	450
J	Cab width - mm	980	980	980	980	980
K	Tumbler distance - mm	3034	3034	3034	3034	3034
L	Track length - mm	3755	3755	3755	3755	3755
M	Undercarriage width std. - mm	2590	2590	2590	2590	2590
N	Shoe width std. - mm	600	600	600	600	600
O	Track height - mm	728	728	728	728	728
P	Ground clearance - mm	410	410	410	410	410

* Component weights

Item	unit		Remarks
Upper structure without front	kg	7870	
Counterweight std.	kg	3500	
Lower structure assembly	kg	5069	
Front assembly	kg	2439	
Boom 4.6 m	kg	795	including bushing
Arm 2.5 m	kg	430	including bushing
Bucket 0.45 m ³	kg	384	
Boom cylinder (each)	kg	240	including bushing
Arm cylinder	kg	143	including bushing
Bucket cylinder	kg	95	including bushing
Dozer blade (2590 mm)	kg	619	600 mm shoe
Dozer cylinder (each)	kg	82	
Two-piece boom lower / upper	kg	385 / 592	including bushing
Two-piece boom, cylinder	kg	150	including bushing
Arm 2.1 m	kg	374	including bushing
Arm 3.0 m	kg	499	including bushing
Dozer blade (2490 mm)	kg	606	500 mm shoe
Dozer blade (2690 mm)	kg	632	700 mm shoe

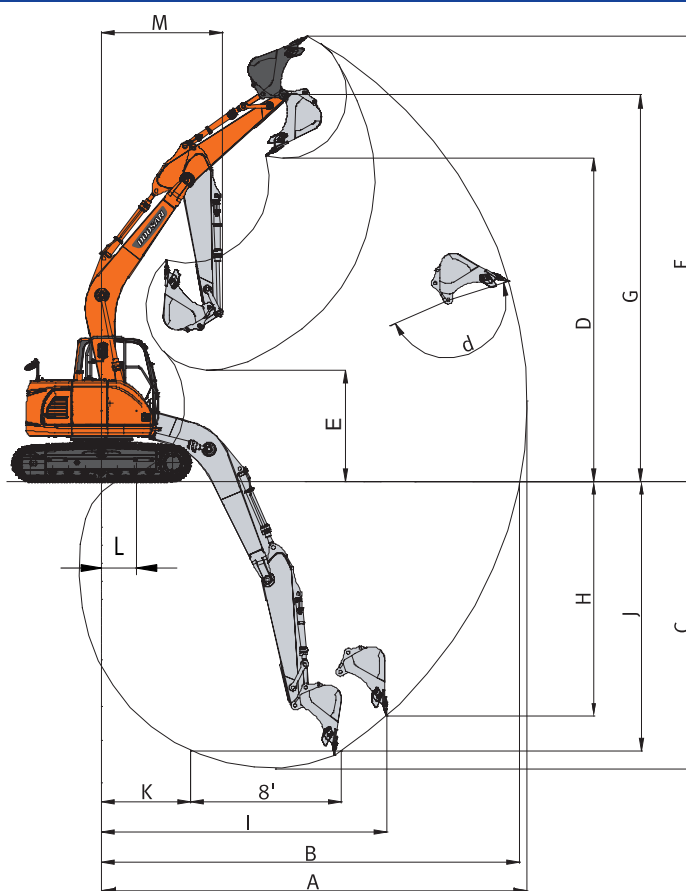

* Working range one-piece and two-piece boom

Boom length - mm		One-piece boom: 4600			Two-piece boom: 4987	
Arm length - mm		2100	2500	3000	2100	2500
Bucket capacity - m ³		0.51	0.45	0.39	0.51	0.45
A	Max. digging reach - mm	7815	8285	8665	8260	8720
B	Max. digging reach (ground) - mm	7660	8140	8530	8115	8585
C	Max. digging depth - mm	5085	5485	5985	5305	5735
D	Max. loading height - mm	6380	6855	7080	6580	7045
E	Min. loading height - mm	2890	2525	2120	3210	2865
F	Max. digging height - mm	8760	9265	9470	8940	9445
G	Max. bucket pin height - mm	7600	8075	8300	7795	8265
H	Max. vertical wall depth - mm	3705	4490	4680	4120	4690
I	Max. radius vertical - mm	5745	5605	5970	5870	5725
J	Max. digging depth (8' level) - mm	4780	5260	5765	5185	5625
K	Min. radius 8' line - mm	1995	2110	2040	910	910
L	Min. digging reach - mm	950	375	-130	2020	1850
M	Min. swing radius - mm	1825	1995	2320	2610	2820
d	Bucket angle - °	174	174	174	174	174

Lifting capacities

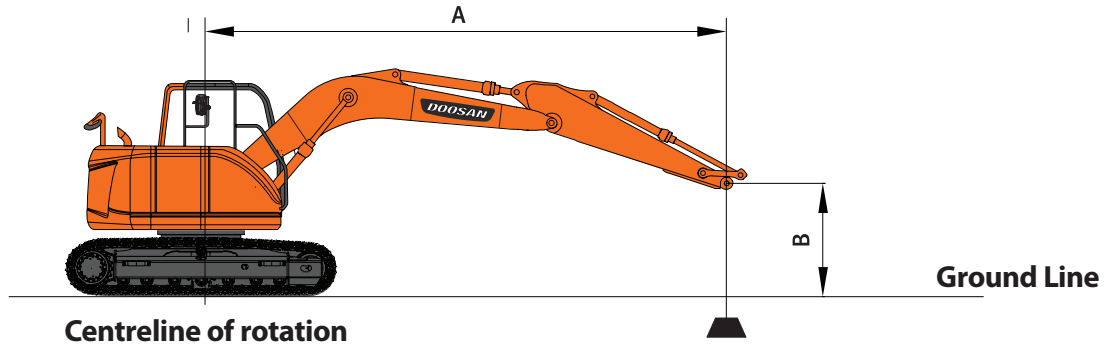

Standard configuration

Standard undercarriage width: 2590 mm • Boom: 4600 mm • Arm: 2500 mm • W/O Bucket • Shoe: 600 mm • Counterweight: 3500 kg

Units: 1000 kg

A (m) \ B (m)	Dozer	1.5		3.0		4.5		6.0		Max. lift		A (m)
7.5	Without			3.80 *	3.80 *					2.74 *	2.74 *	3.63
	Dozer up			3.80 *	3.80 *					2.74 *	2.74 *	3.63
6.0	Without					3.66 *	3.66 *			2.16 *	2.16 *	5.42
	Dozer up					3.66 *	3.66 *			2.16 *	2.16 *	5.42
4.5	Without			3.97 *	3.97 *	4.25 *	3.83	3.19 *	2.4	2.00 *	2.00 *	6.40
	Dozer up			3.97 *	3.97 *	4.25 *	4.04	3.19 *	2.54	2.00 *	2.00 *	6.40
3.0	Without			7.24 *	6.85	5.26 *	3.63	3.69	2.33	2.00 *	1.85	6.91
	Dozer up			7.24 *	7.21	5.26 *	3.83	4.13	2.48	2.00 *	1.97	6.91
1.5	Without			8.31 *	6.13	5.59	3.39	3.59	2.23	2.11 *	1.74	7.07
	Dozer up			8.31 *	6.49	6.24	3.59	4.02	2.38	2.11 *	1.86	7.07
0 (Ground)	Without			7.17 *	5.83	5.39	3.22	3.5	2.15	2.36 *	1.77	6.90
	Dozer up			7.17 *	6.2	6.04	3.42	3.93	2.3	2.36 *	1.89	6.90
-1.5	Without	5.40 *	5.40 *	10.36 *	5.81	5.33	3.16	3.47	2.13	2.89 *	1.98	6.36
	Dozer up	5.40 *	5.40 *	10.36 *	6.17	5.97	3.36	3.9	2.27	2.89 *	2.11	6.36
-3.0	Without	9.21 *	9.21 *	8.78 *	5.93	5.38	3.21			4.15	2.54	5.37
	Dozer up	9.21 *	9.21 *	8.78 *	6.29	5.99 *	3.41			4.21 *	2.7	5.37

Option 1 Rubber pads

Standard undercarriage width: 2490 mm • Boom: 4600 mm • Arm: 2500 mm • W/O Bucket • Shoe: 500 mm Rubber • Counterweight: 3500 kg

Units: 1000 kg

A (m) \ B (m)	Dozer	1.5		3.0		4.5		6.0		Max. lift		A (m)
7.5	Without			3.80 *	3.80 *					2.74 *	2.74 *	3.63
	Dozer up			3.80 *	3.80 *					2.74 *	2.74 *	3.63
6.0	Without					3.66 *	3.66 *			2.16 *	2.16 *	5.42
	Dozer up					3.66 *	3.66 *			2.16 *	2.16 *	5.42
4.5	Without			3.97 *	3.97 *	4.25 *	3.74	3.19 *	2.34	2.00 *	2.00 *	6.40
	Dozer up			3.97 *	3.97 *	4.25 *	3.91	3.19 *	2.46	2.00 *	2.00 *	6.40
3.0	Without			7.24 *	6.69	5.26 *	3.54	3.59	2.27	2.00 *	1.8	6.91
	Dozer up			7.24 *	6.99	5.26 *	3.71	3.97	2.39	2.00 *	1.9	6.91
1.5	Without			8.31 *	5.96	5.44	3.3	3.48	2.17	2.11 *	1.69	7.07
	Dozer up			8.31 *	6.27	6	3.47	3.86	2.29	2.11 *	1.79	7.07
0 (Ground)	Without			7.17 *	5.67	5.24	3.13	3.4	2.09	2.36 *	1.72	6.90
	Dozer up			7.17 *	5.98	5.81	3.3	3.77	2.21	2.36 *	1.82	6.90
-1.5	Without	5.40 *	5.40 *	10.36 *	5.65	5.17	3.07	3.37	2.07	2.89 *	1.92	6.36
	Dozer up	5.40 *	5.40 *	10.36 *	5.96	5.74	3.24	3.75	2.19	2.89 *	2.03	6.36
-3.0	Without	9.21 *	9.21 *	8.78 *	5.77	5.23	3.12			4.03	2.47	5.37
	Dozer up	9.21 *	9.21 *	8.78 *	6.07	5.8	3.29			4.21 *	2.61	5.37

1. Lifting capacities are in compliance with ISO 10567:2007(E).

2. The load point is at the end of the arm.

3. * = The nominal loads are based on hydraulic capacity.

4. The nominal loads shown do not exceed 75% of tipping loads or 87% of hydraulic lifting capacity.

5. For lifting capacity with bucket, simply subtract the actual weight of the bucket from the values.











6. The configurations indicated do not necessarily reflect the standard equipment of the machine.

: Rating over front
 : Rating over side or 360°

Option 2 Two-piece boom

Standard undercarriage width: 2590 mm • Boom: 4987 mm • Arm: 2500 mm • W/O Bucket • Shoe: 600 mm • Counterweight: 3500 kg

Units: 1000 kg

A (m) \ B (m)	Dozer	3.0		4.5		6.0		7.5		Max. lift		A (m)
												
7.5	Without									2.77 *	2.77 *	4.44
	Dozer up									2.77 *	2.77 *	4.44
6.0	Without			3.35 *	3.35 *					2.29 *	2.29 *	5.98
	Dozer up			3.35 *	3.35 *					2.29 *	2.29 *	5.98
4.5	Without			3.81 *	3.81 *	3.63 *	2.39			2.13 *	1.87	6.88
	Dozer up			3.81 *	3.81 *	3.63 *	2.53			2.13 *	1.99	6.88
3.0	Without			4.83 *	3.55	3.67	2.29			2.12 *	1.63	7.36
	Dozer up			4.83 *	3.76	4.04 *	2.43			2.12 *	1.74	7.36
1.5	Without			5.49	3.26	3.54	2.16	2.24 *	1.54	2.21 *	1.54	7.50
	Dozer up			5.99 *	3.47	3.97	2.31	2.24 *	1.65	2.21 *	1.64	7.50
0 (Ground)	Without			5.28	3.08	3.43	2.07			2.43 *	1.56	7.34
	Dozer up			5.93	3.28	3.86	2.21			2.43 *	1.67	7.34
-1.5	Without	7.42 *	5.59	5.21	3.02	3.39	2.03			2.83	1.71	6.85
	Dozer up	7.42 *	5.95	5.86	3.22	3.82	2.17			2.87 *	1.83	6.85
-3.0	Without	9.24 *	5.72	5.27	3.07					3.52	2.13	5.94
	Dozer up	9.24 *	6.08	5.92	3.27					3.83 *	2.27	5.94





* Standard equipment

Engine
Cummins QSB4.5 Diesel engine combined with e-EPOS System, Common Rail direct injection, EU Stage IIIB compliant
EGR and Cummins Compact Catalyst system
Auto-idle
Hydraulic system
Boom and arm flow regeneration
Swing anti-rebound valves
Spare ports (valve)
One-touch power boost
Breaker piping
Cylinder cushioning & contamination seals
Control of auxiliary hydraulic flow and pressure from the display panel
Cab & Interior
Roll Over Protective Structure (ROPS)
Sound-insulated and viscous support mounted cab
Heated, adjustable air suspension seat with adjustable headrest and armrest
Attachment management system
Air conditioning
Pull-up type front window with sun roller blind and removable lower front window
Sliding left windows
Ceiling light
Intermittent upper windshield wiper
Multiple storage compartments
Rain visor
Flat, spacious, easy-to-clean floor
Cigarette lighter and ashtray
Cup holder
Anti-theft protection
Fuel control dial
7" (18 cm) LCD colour monitor panel
Engine speed (RPM) control dial
Hydrostatic 2-speed travel system with manual or automatic shift
Automatic rear window defroster
3 operating modes & 3 working modes
Radio-ready and remote radio ON/OFF switch
12 V power socket
Serial communication port for laptop PC interface
Adjustable PPC wrist control levers for arm, boom, bucket and swing, with sliding proportional control for attachments, auxiliary hydraulic buttons and one-touch power boost
Tool storage area
Travel pedals and hand levers
Master key
Safety
Boom and arm cylinder safety valves
Overload warning device
Large handrail and step
Rotating beacon
Rear view camera
Punched metal anti-slip plates
Hydraulic safety lock lever
Safety glass
Hammer for emergency escape
Right and left rearview mirrors
Emergency engine stop and hydraulic pump control switches
Engine overheat and restart prevention system
Parking brake and cab swing lock pin
Reinforced cast steel pivot points
Upperstructure maintenance compartment doors and lockable fuel cap
Battery cut-off switch
Halogen work lights (1 front frame, 4 front cab-mounted, 2 rear cab-mounted, 2 boom-mounted and 1 rear side)
Mirror on counterweight
Other
Mono boom: 4600 mm – arm: 2500 mm
Counterweight: 3500 kg
Auto shut-off fuel filler pump
Double element air cleaner
Fuel pre-filter with water separator sensor
Dust screen for radiator/oil cooler
Separated engine hoods with gas spring
Self-diagnostic function
Battery (2 x 12 V, 100 Ah), alternator (24 V, 70 A)
Electric horn
Remote greasing for swing circle and workgroup pivot points
Guards for boom lights
Undercarriage
Fixed undercarriage 2590 mm
Hydraulic track adjuster
Normal track guards
Greased and sealed track links
600 mm triple grouser shoe

* Optional equipment

Cab & Interior
MP3/USB radio with CD player
Safety
FOGS cab - top and front cab guards (ISO 10262)
Other
Two-piece boom: 4987 mm with 2100 or 2500 mm arm
Arms: 2100 or 3000 mm
Doosan buckets: full range of GP, HD & Rock buckets
Doosan breaker: DXB100H and Doosan quick-couplers
Hydraulic piping for crusher, quick coupler, clamshell, tilting and rotating buckets
Additional filter for breaker piping
Wiper for lower front window
Straight travel pedal
Telescopic rotating beacon
Bio oil
Automatic lubrication system
Alarm for travel & swing
Alarm for travel
Undercarriage
500 or 700 mm triple grouser shoe and 500 mm rubber pads
Dozer blade: 2490 or 2690 mm



Rubber pads
Reduce noise and vibrations and help minimize damage on asphalt, pavement or any easily damaged surfaces.



Two-piece boom
Two-piece boom configuration offering a maximum digging reach of 8720 mm.

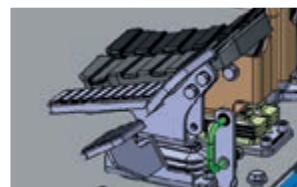

Straight travel pedal
Allows more operator comfort when multi-tasking.

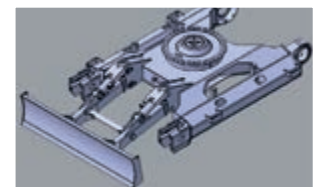

Dozer blade
For dozing and working on sloped terrains. It also increases stability when lifting.



Doosan buckets
A range of dependable Doosan buckets is available to cover several applications.



Doosan breakers and quick-couplers
Doosan provides the tough, reliable equipment you need for demolition work.

Some of these options may be standard in some markets. Some of these options may not be available for certain markets. Please check with your local DOOSAN dealer for more information about availability or to adapt your machine to your application needs.



Doosan Infracore Construction Equipment

A partner you can trust



**Finance
your
ambitions**



www.doosanequipment.eu



**100%
GENUINE
PARTS**
Totally Doosan

Financial Solutions

Doosan Infracore Financial Services (DI FS) is specialised in creating financing solutions to meet a wide variety of needs. Contact your local dealer for more information.

Always a dealer near you

Our well-developed dealer network has the knowledge and experience to take the best care of our Doosan customers. No matter where you are, you'll get the service you expect - and can rely on!

Parts & Service

- Complete parts & service support for all Doosan products
- Highest quality genuine parts
- Large, dedicated staff of factory-trained aftermarket professionals in the field



www.doosanequipment.eu

