

Hyper
BIKE CO.

B I C Y C L E O W N E R ' S M A N U A L

E-Ride



ATTENTION!

To activate your limited Lifetime Warranty please register your purchase at www.hypertoys.com or www.hyperbicycles.com and select Warranty Registration.

The following manual is only a guide to assist you and is not a complete or comprehensive manual of all aspects of maintaining and repairing your bicycle. The bicycle you have purchased is a complex object. **Hyper Bicycles** recommends that you consult a bicycle specialist if you have doubts or concerns as to your experience or ability to properly assemble, repair, or maintain your bicycle. You will save time and the inconvenience of having to go back to the store if you choose to write or call us concerning missing parts, service questions, operating advice, and/or assembly questions.



177 Malaga Park Dr.
Malaga, NJ 08328

Toll Free: 1-866-204-9737

Monday-Friday 8:00AM to 5:00PM (CST)

For product related questions email us at: info@hyperbicycles.com

For customer service questions email us at: service@hyperbicycles.com

IMPORTANT NOTICE

WRITE YOUR SERIAL NUMBER HERE

Keep your serial number handy in case of damage, loss or theft.

TOLL FREE SERVICE HOTLINE
1-866-204-9737

SERIAL NUMBER LOCATION Bottom View

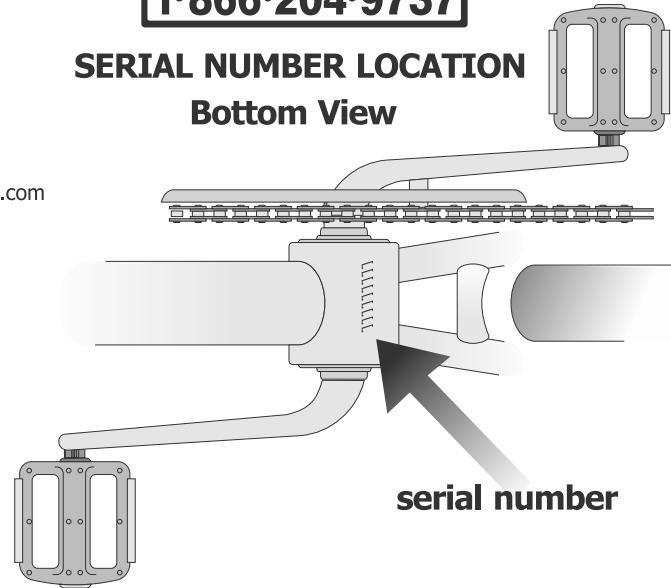

BICYCLE OWNER'S MANUAL

Hyper
BIKE CO.

E-Ride

May not be
exactly as
shown



26in MAX WEIGHT : 275 lb, (124 kg)

This manual contains important safety, performance and maintenance information. Please read this manual before taking your first ride on your new bicycle, and keep this manual handy for future reference.



VISIT US ONLINE@
www.hyperbicycles.com

If you have a problem, do not return to the store, call 1-866-204-9737. Adult Supervision Required when in use. For parts or repair service, call Hyper Bicycles at 1-866-204-9737.

Contents

SAFETY

Safety Equipment	2
Mechanical Safety Check	3
Riding Safety	5
⚠ IMPORTANT NOTE TO PARENTS	5
Rules of the Road	7
Rules of the Trail	9
Wet Weather Riding	10
Night Riding	10
Bicycling in Traffic	11

ASSEMBLY, MAINTENANCE AND ADJUSTMENT

Owners Responsibility	13
Tools	14
Battery	15
Controller	23
Electric Motor	24
Reflectors	26
Pedals & Saddle	28
Handlebar and Stem	30
Front Wheel	32
Brakes	33
Derailleurs	40
Tire Valves	42
Tires	43
Repair and Service	45
Fenders	51

NEW OWNER

Warranty	52
Purchase Record	53

TOLL FREE SERVICE HOTLINE
1-866-204-9737





SAFETY EQUIPMENT

WARNING! Most countries require specific safety devices. It is your responsibility to familiarize yourself with the laws of the jurisdiction where you ride and to comply with all applicable laws, including properly equipping yourself and your bike as the law requires.

1. HELMET

While not all areas require bicyclists to wear approved protective headgear, common sense dictates that you should wear an ANSI or Snell approved helmet whether the law requires it or not. Most serious bicycle injuries involve head injuries which might have been avoided if the rider had worn a helmet. Your dealer has a variety of attractive helmets, and can recommend one to suit.

Right Way



Wrong Way



your needs. Your helmet must fit correctly, be worn correctly and be properly secured to perform optimally. Ask your dealer to help you with the fit and adjustment of your helmet.

WARNING! Always wear a helmet when riding your bike. Always keep the chin strap securely buckled. Failure to wear an approved helmet may result in serious injury or death.

2. REFLECTORS

Reflectors are important safety devices which are designed as an integral part of your bicycle.

Local regulations require every bicycle to be equipped with front, rear, wheel and pedal reflectors. The size, performance and location of each reflector is specified locally. The reflectors are designed to pick up and reflect car lights in a way that helps you to be seen and recognized as a moving bicyclist.

CAUTION! Check reflectors and their mounting brackets regularly to make sure that they are clean, straight, unbroken and securely mounted. Have your dealer replace damaged reflectors and straighten or tighten any that are bent or loose.

WARNING! Do not remove the reflectors or reflector mounting brackets from your bicycle. They are an integral part of the bicycle's safety system. Removing the reflectors may reduce your visibility to others using the roadway.

Being struck by other vehicles often results in serious injury or death. Remember reflectors are not a substitute for lights. Always equip your bicycle with all state and locally mandated lights.

3. LIGHTS

We strongly recommend that children not ride after dusk or before daylight. If you must ride your bike after dusk or before full daylight, your bicycle must be equipped with lights so that you can see the road and avoid road hazards; and so that others can see you. Vehicle laws treat bicycles like any other vehicle. That means you must have a white front and a red rear light operating if you are riding after dusk or before full daylight. Your bike dealer can recommend a battery or generator powered lighting system appropriate to your needs.

WARNING: Reflectors are not a substitute for proper lights. It is your responsibility to equip your bicycle with all locally mandated lights. Riding at dawn, at dusk, at night or at other times of poor visibility without a bicycle lighting system which meets local laws and without reflectors is dangerous and may result in serious injury or death.

4. PEDALS

Some higher performance model bicycles come equipped with pedals that have sharp and potentially dangerous surfaces. These surfaces are designed to

add safety by increasing adhesion between the rider's shoe and the bicycle pedal. If your bicycle has this type of high-performance pedal you must take extra care to avoid serious injury from the pedals' sharp surfaces.

Based on your riding style or skill level, you may prefer a less aggressive pedal design. Your dealer can show you a number of options and make suitable recommendations.

MECHANICAL SAFETY CHECK

Here is a simple, sixty-second mechanical safety check which you should get in the habit of making every time you're about to get on a bike.

1. NUTS, BOLTS

Lift the front wheel off the ground by two or three inches, then let it bounce on the ground. Anything sound, feel or look loose? Do a quick visual and tactile inspection of the whole bike. Any loose parts or accessories? If so, secure them. If you're not sure, ask someone with experience to check.

2. TIRES & WHEELS

Tires correctly inflated? Check by putting one hand on the saddle, one on the intersection of the handlebars and stem, then bouncing your weight on the bike while looking at tire deflection. Compare what you see with how it looks when you know the tires are correctly inflated.



**BICYCLE
SAFETY**



Tires in good shape? Spin each wheel slowly and look for cuts in the tread and sidewall. Replace damaged tires before riding the bike.

Wheels true? Spin each wheel and check for brake clearance and side-to-side wobble. If a wheel wobbles side to side or hits the brake pads, take the bike to a qualified bike shop to have the wheel trued.

CAUTION: Wheels must be true for hand brakes to work effectively. Wheel truing is a skill which requires special tools and experience. Do not attempt to true a wheel unless you have the knowledge and tools needed to do the job correctly.

3. BRAKES

If your bicycle has hand-operated brakes, squeeze the brake levers. Are the brake shoes contacting the wheel rim within an 1in, (25.4mm) of brake lever movement? Can you apply full braking force at the levers without having them touch the handlebar? If not, your brakes need adjustment. **Do not ride the bike until the brakes are properly adjusted.**

WARNING: Riding with improperly adjusted and secured brakes or worn brake shoes is dangerous and can result in serious injury or death.

4. WHEEL NUTS

Are the front and rear wheels straight and secure in the dropouts? Are the wheel nuts properly tightened?

WARNING: Riding with an improperly installed or insufficiently tightened wheel can cause the wheel to wobble or disengage from the bicycle, which can cause damage to the bicycle and serious injury or death.

5. HANDLEBAR AND SADDLE ALIGNMENT

Are the saddle and handlebar stem correctly parallel to the bike's top tube and tight enough so that you can't twist them out of alignment?

6. HANDLEBAR ENDS

Are the handlebar grips secure and in good condition? If not, replace them. Are the handlebar ends plugged? If not, plug them before you ride.

WARNING: Loose or damaged handlebar grips can cause you to lose control and fall. Unplugged handlebars can act like a cookie cutter on your body, and cause serious injury in an otherwise minor accident.

RIDING SAFELY AND RESPONSIBLY

Like any sport, bicycling involves risk of injury and damage. By choosing to ride a bicycle, you assume the responsibility for that risk. Not the people who sold you the bike. Not the people who made it. Not the people who distribute it. Not the people who manage or maintain the roads or trails you ride on. You. So you need to know and to practice the rules of safe and responsible riding. Riding an electrically assisted bike allows you to use less pedaling energy to attain the same or higher speeds than you would with a traditional bicycle. This requires a higher level of attention to traffic, pedestrian and all the conditions that could affect your ride. Your Hyper e-Ride is limited to a top speed of 20 mph, but this is a higher speed than you are probably used to on non-assisted bicycles, so additional care and awareness are required.

AN IMPORTANT NOTE TO PARENTS

In addition to **The Basics** (page 7), the **Rules of the Road** (page 7), the **Rules of the Trail** (page 9), **Wet Weather Riding** (page 10), **Night Riding** (page 10) and **Bicycling in Traffic** (page 11) kids need to be taught...and to have frequently reinforced... The following rules and lessons which adults are already expected to know. We urge you to take the time to familiarize yourself with these rules and to teach them to your child before you let your child ride unsupervised.

1. RULES

- **No playing in the road or in the street**
- **No riding on busy streets**
- **No riding at night**
- **Stop for all STOP signs**
- **Ride on the right of traffic**

2. LESSONS

The lessons that follow relate to some of the most common real situations that children encounter when riding their bikes. Go over these situations with your child and make sure the lesson objective is accomplished.

Driveway Ride-Out: When a youngster rides out of the driveway and is struck by a car, that is called a ride-out accident.

What can you do?

First, realize the danger of your own driveway. If there are obstructions to the view of passing motorists (like bushes or trees), trim them back. You might park your car in front of the driveway, if local ordinance permits. This way, your child can't use the driveway as a launching pad.

But the most important thing you can do is teach your child about driveway safety. Take your child outside to the driveway and have him/her practice the following steps:

- **Stop before entering the street**
- **Look left, right and left again for traffic**
- **If there's no traffic, proceed into the roadway**

Running the Stop Sign: Car/bike crashes can happen when a cyclist runs a stop sign. Most cyclists who get hit riding through stop signs know that they



**BICYCLE
SAFETY**



were supposed to stop. They just thought it would be OK this time; or they may have been distracted. The thing to impress upon your child is that while he/she may not get hit every time, running stop signs will eventually result in an accident.

What can you do?

Take your child to a stop sign near home. Explain what it means by emphasizing the following points:

- 1). Stop at all stop signs, regardless of what is happening.
- 2). Look in all directions for traffic.
- 3). Watch for oncoming cars making left turns.
- 4). Watch for cars behind you making right turns.
- 5). Wait for any cross traffic to clear.
- 6). Proceed when safe.

In order to make this lesson stick, you may have to change your own driving habits. If you creep through intersections controlled by stop signs, you are showing your child that you don't really believe what you preach. For your child's sake, stop at stop signs.

Turning Without Warning: Another major accident type involves cyclists who make unexpected left turns. They neither look behind for traffic, nor do they signal. The key factor here is neglecting to look to the rear: If the cyclist had looked, he/she would have seen the danger coming up from behind.

What can you do?

Of course, you ought to teach your child not to ride across busy streets - at least until the child has had some advanced training and is old enough to understand traffic. But in the meantime, for residential street riding, you can teach your child to always look and signal before turning left. A big part of this lesson is teaching the child how to look to the rear without swerving.

Take your child to a playground to practice riding along a straight line while looking behind. Stand alongside and hold up a different number of fingers on your hand after the child rides by. Call his/her name. After 15 minutes of practice, a ten year old should be able to look behind his/herself and identify how many fingers you are holding up - without swerving.

Night Time Riding (See also page 10).

Most car/bicycle accidents happen at night where an overtaking car hits a bike. (An overtaking car is one that comes up from behind and passes the cyclist on the left.) These overtaking accidents can be very serious.

What can you do?

First, you should keep your youngster from riding at night. It requires special skills and equipment. Few children have either. Secondly, make sure your child understands that if he/she gets caught out after dark on a bike, the thing to do is to call you for a ride home.

Following the Leader: There is increased risk of car/bike collision if children are following each other, because if the first one does something dangerous, those following may do it too.

What can you do?

Teach your child to always assess the traffic situation for him/herself. When a group is riding around, each cyclist should stop for stop signs; each cyclist should look to the rear before making left turns; and so on. One way to get the message across is to play a game with the child similar to 'Simon Says'. In this game, however, the emphasis should not be on doing what 'Simon Says', but rather have the child make a decision based on the situation. The child should learn to ignore what 'Simon Says'. Children need to learn to think for themselves to ride safely.

SUMMARY: Teach your child early - the earlier the better. Learning skills such as looking and avoiding hazards takes time. Be prepared to repeat lessons until your child understands what you're trying to get across. Be patient. Your efforts will be rewarded, knowing that your child is aware of safe riding skills.

THE BASICS

- 1.** Always do the Mechanical Safety Check before you get on a bike.
- 2.** Be thoroughly familiar with the controls of your bicycle.
- 3.** Be aware that your e-bike may reach higher speeds easier than non-powered bikes.

4. Be careful to keep body parts and other objects away from the sharp teeth of chain rings; the moving chain; the turning pedals and cranks; and the spinning wheels of your bicycle.

5. Always wear a cycling helmet which meets the latest Snell or ANSI standard.

6. Always wear shoes that will stay on your feet and will grip the pedals. Never ride barefoot or wearing sandals.

7. Wear bright, visible clothing that is not so loose that it can catch on moving parts of the bicycle or be snagged by objects at the side of the road or trail.

8. Don't jump with your bike. Jumping a bike, particularly a BMX bike, can be fun; but it puts incredible stress on everything from your spokes to your pedals. Doing jumps on bikes risks serious damage to the bike and the rider.

RULES OF THE ROAD

1. Learn the local bicycle laws and regulations, especially those pertaining to electrically assisted bicycles in your area. Many communities have special regulations about licensing of bicycles, riding on sidewalks, law regulating bike path and trail use, and so on. Many states have helmet laws, child carrier laws and special bicycle traffic laws.



**BICYCLE
SAFETY**





special bicycle traffic laws. In the U.S. And in most foreign countries, a bicyclist is required to obey the same traffic laws as the driver of a car or motorcycle. It's your responsibility to know and obey the laws.

2. You are sharing the road or the path with others - motorists, pedestrians and other cyclists. Respect their rights, and be tolerant if they infringe on yours.

3. Ride defensively. Assume that the people with whom you are sharing the road are so absorbed with what they are doing and where they are going that they are oblivious to you.

4. Look ahead of where you're going, and be ready to avoid:

- Vehicles slowing or turning in front of you, entering the road or your lane ahead of you, or coming up behind.
- Parked car doors opening in front of you.
- Pedestrians stepping out in front of you.
- Children playing near the road.
- Pot holes, sewer grating, railroad tracks, expansions joints, road or sidewalk construction, debris and other obstructions that could cause you to swerve into traffic, catch your wheel or otherwise cause you to lose control and have an accident.

The many other hazards and distractions which can occur on a bicycle ride.

5. Ride in designated bike lanes, on designated bike paths or on the right side of the road, in the same direction as car traffic and as close to the edge of the road as possible.

6. Stop at stop signs and traffic lights; slow down and look both ways at street intersections. Remember that a bicycle always loses in a collision with a motor vehicle, so be prepared to yield even if you have the right of way.

7. Use hand signals for turning and stopping. Learn the local vehicle code for the correct signals.

8. Never ride with headphones. They mask traffic sounds and emergency vehicle sirens, distract you from concentrating on what's going on around you, and their wires can tangle in the moving parts of the bicycle, causing you to lose control.

9. Never carry a passenger.

10. Never carry anything which obstructs your vision or your complete control of the bicycle, or which could become entangled in the moving parts of the bicycle.

11. Never hitch a ride by holding on to another vehicle.

12. Don't do stunts, wheelies or jumps. They can cause you injury and damage your bike.

13. Don't weave through traffic or make any moves that may surprise people with whom you are sharing the road.

14. Observe and yield the right of way.

15. Never ride your bicycle while under the influence of alcohol or drugs.

16. If possible, avoid riding in bad weather, when visibility is obscured, at dusk or in the dark, or when extremely tired. Each of these conditions increases the risk of accident.

RULES OF THE TRAIL

1. We recommend that children not ride off-road without the accompaniment of an adult. In any event, never ride alone in remote areas. Even when riding with others, make sure that someone knows where you're going and when you expect to be back. Always take along some kind of identification, so that people know who you are in case of an accident.

2. Surface hazards make off-road riding much more difficult and therefore more dangerous than riding on paved roads. Start slowly and build up your skills on easier terrain before tackling the more difficult.

3. Learn and obey the local laws regulating where and how you can ride off-road, and respect private property. Don't ride where you are not welcome or where you are not allowed. Rules for e-Bikes may differ from non-powered bikes.

4. You are sharing the trail with others - hikers, equestrians, other cyclists. Respect their rights, and be tolerant if they inconvenience you.

5. Yield right of way to pedestrians and animals. Ride in a way that does not frighten or endanger them, and stay far enough away so that their unexpected moves don't endanger you.

6. You may be riding in sensitive habitat, so stay on the designated trail. Don't contribute to erosion by riding in mud or with unnecessary sliding. Don't disturb wildlife or livestock; and don't disturb the ecosystem by cutting your own trail through vegetation or streams.

7. It is your responsibility to minimize your impact on the environment. Ride accordingly. Leave things as you found them; and always take out everything you brought in.

8. If you crash: First, check yourself for injuries, and take care of them as best you can.

Next, check your bike for damage, and fix what you can.

Then, when you get home, carefully perform the maintenance procedure described this manual and check for any other damaged parts. All bent, scored or discolored parts are suspect and should be replaced.



WARNING: A crash can put extraordinary stress on bicycle components, causing them to fatigue prematurely. Components suffering from stress fatigue can fail suddenly and catastrophically, causing loss of control, serious injury or death.



CAUTION: If you have any doubt about the condition of the bicycle or any of its parts, take it to your dealer for a thorough check.



**BICYCLE
SAFETY**



WET WEATHER RIDING

 **WARNING:** Wet weather impairs traction, braking and visibility, both for the bicyclist and for other vehicles sharing the road. The risk of accident is dramatically increased in wet conditions.

Under wet conditions, the stopping power of your brakes (as well as the brakes of other vehicles sharing the road) is dramatically reduced and your tires don't grip nearly as well. This makes it harder to control speed and easier to lose control. To make sure that you can slow down and stop safely in wet conditions, ride more slowly and apply your brakes earlier and more gradually than you would under normal, dry conditions.

NIGHT RIDING

Riding a bicycle at night is many times more dangerous than riding during the day. Therefore, children should never ride at dawn, at dusk or in the dark. Adults should not ride at dawn, at dusk or at night unless it is absolutely necessary.

 **WARNING:** Riding at dawn, at dusk, at night or at other times of poor visibility without a bicycle lighting system, which meets local laws and without reflectors, is dangerous and can result in serious injury or death.

Even if you have excellent night vision, many of the

people with whom you're sharing the road don't. A bicyclist is very difficult for motorists and pedestrians to see at dawn, at dusk, at night or at other times of poor visibility. If you must ride under these conditions, check and be sure you comply with all local laws about night riding: follow the Rules of the Road and of the Trail even more carefully; and make sure to take the following additional precautions:

Before riding at dawn, at dusk, at night or at other times of poor visibility, take the following steps to make yourself more visible:

1. Make sure that your bicycle is equipped with correctly positioned and securely mounted reflectors
2. Purchase and install an adequate battery or generator powered head and tail light.
3. Wear light colored, reflective clothing and accessories, such as a reflective vest, reflective arm and leg bands, reflective stripes on your helmet, flashing lights...any reflective device or light source that moves will help you get the attention of approaching motorists, pedestrians and other traffic.
4. Make sure your clothing or anything you may be carrying on the bicycle does not obstruct a reflector or light.

While riding at dawn, at dusk, at night or at other times of poor visibility:

- Ride slowly.
- Avoid areas of heavy traffic, dark areas, and roads with speed limits over 35 mph, (56 km/h).
- Avoid road hazards.
- If possible, ride on routes already familiar to you.

BICYCLING IN TRAFFIC

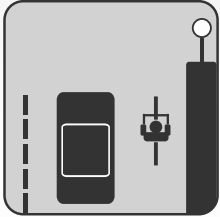

Obey traffic signs and signals. Bicycles must drive like the other vehicles if they are to be taken seriously by the motorists.

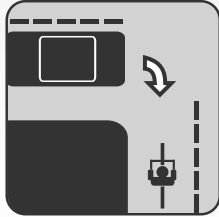

Never ride against traffic. Motorists aren't looking for bicyclists on the wrong side of the road.

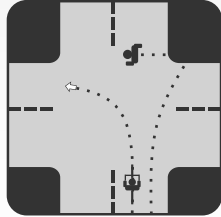

Choose best way to turn left. There are two ways to make a left turn. #1 Like an auto signal, move into the left lane and turn left. #2 Like a pedestrian ride straight to the far side crosswalk. Walk your bike across.

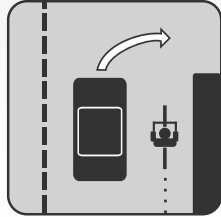

Don't pass on the right. Motorists may not look for or see a bicycle passing on the right.



Go slow on sidewalks. Pedestrians have the right of way. By law you must give pedestrians an audible warning when you pass. Don't cross driveways or intersections without slowing to a walkers pace and looking very carefully for traffic. Especially traffic turning right on a green light.

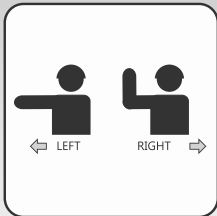

Use hand signals - Hand signals, using your left arm, tell motorists what you intend to do. Signal as a matter of law, courtesy and safety.

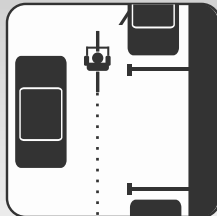

Ride in a straight line - Whenever possible, ride in a straight line, to the right of traffic, but about a car door's width away from parked cars.

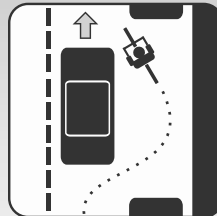

Don't weave between parked cars - Don't ride out to the curb between parked cars unless they are far apart. Motorists may not see you when you try to move back into traffic.

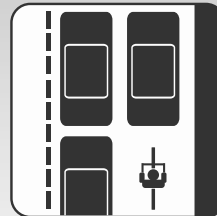

Ride in middle of lane in slow traffic - Get in the middle of the lane at busy intersections and whenever you are moving at the same speed as traffic.

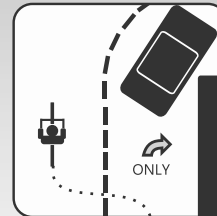

Follow lane markings - Don't turn left from right lane. Don't go straight in a lane marked 'Right Turn Only.'

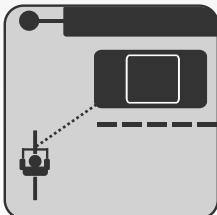

Watch for cars pulling out - Make eye contact with driver. Assume they don't see you until you are sure they do.

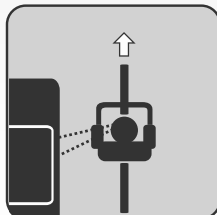

Scan the road behind - Learn to look back over your shoulder without losing your balance or swerving left. Some riders use rear view mirrors.

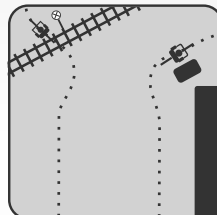

Avoid road hazards - Watch out for parallel slat sewer grates, slippery manhole cover, oily pavement, gravel and ice. Cross railroad tracks carefully at right angles. To get better control as you move across bumps and other hazards, stand up on your pedals.

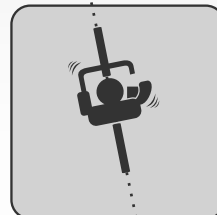

Keep both hands ready to brake - You may not stop in time if you brake one-handed. Allow extra distance for stopping in the rain, since brakes are less efficient when wet.



Watch for chasing dogs - Ignore them or try a firm "No!" If the dog doesn't stop, dismount with your bike between you and the dog. Dogs are attracted to spinning wheels and feet.

Riding Safety and Responsibility

The Owner's Responsibility

⚠ WARNING: This bicycle is made to be ridden by one rider at a time for general transportation and recreational use. It is not made to withstand the abuse of stunting and jumping.

If the bicycle was purchased unassembled, it is the owner's responsibility to follow All assembly and adjustment instructions exactly as written in this manual and any "Special Instructions" supplied with the bicycle. The owner must make sure all components are securely attached.

If the bicycle was purchased assembled, it the owner's responsibility, before riding the Bicycle for the first time, to make sure the bicycle is assembled and adjusted exactly As written in this manual and any "Special Instructions" supplied with the bicycle. The owner must make sure all components are securely attached.

Fitting the Rider to the Bicycle

To determine the correct size of bicycle for the rider

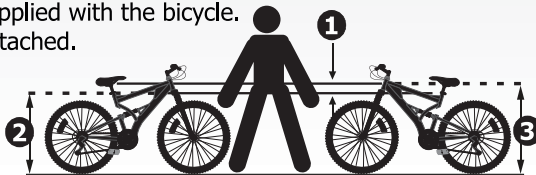

straddle the assembled bicycle with feet shoulder width apart and flat on the ground.

There must be at least 1 in, (2.5 cm), of clearance (1) between the lowest part of the seat (2) and the crotch of the rider

The minimum leg-length for the rider is the lowest part of the seat plus 1 in, (2.5 cm) (3).

The rider must be able to easily reach and operate the brake levers (if so equipped).



**BICYCLE
SAFETY**





TOOLS REQUIRED



RIDE RIGHT
WEAR A HELMET WHEN YOU RIDE

TOOLS/TECHNICAL SUPPORT

Your new bicycle was assembled and tuned in the factory and then partially disassembled for shipping. You may have purchased the bicycle already full re-assembled and ready to ride OR in the shipping carton in the partially disassembled form. The following instructions will enable you to prepare your bicycle for years of enjoyable cycling. Please check that all parts referred to in the instructions and shown in the diagram have been included, and that all tools needed are at your disposal. For more details on inspections, lubrication, maintenance and adjustment of any area please refer to the relevant sections in this manual. If you need replacement parts or have questions pertaining to assembly of your bicycle, contact Hyper Bicycles directly.

VISIT US ONLINE@ For product related questions email us at: info@hyperbicycles.com
www.hyperbicycles.com For customer service questions email us at: service@hyperbicycles.com

HYPER BICYCLES SERVICE AND TECHNICAL SUPPORT:
 1-866-204-9737 OR 1-866-20-(HYPER)
 Monday - Friday (8:00AM - 5:00PM - CST)

Tools Required:

- Phillips head screw driver.
- 5mm and 6mm allen keys.
- Adjustable wrench or 9mm, 10mm, 14mm & 15mm open or box end wrenches.
- Pliers with cable cutting ability.



To avoid injury, this product must be properly assembled before use. If your bicycle was obtained after assembled, we strongly recommended that you review the complete assembly instructions and maintenance checks specified in this manual before riding.

Battery Removal and Installation

! **WARNING!** As with all electric appliances you must operate your E-Ride battery system with care. Do not store your charger or battery in any place where they could get wet or be subject to high heat. The storage area should be well ventilated.

Security: You are supplied with 2 keys to secure your battery to your bike. It is advisable to separate the keys and store one in a safe place. You can also unlock your battery enabling you to remove it for security or to charge the battery when removed from the bike.

Battery Installation

Step 1: Insert the key into battery frame lock. Turn key to the left, counter-clockwise, 180 degrees to "Secure" battery frame lock. The battery is now ready to install.

**BATTERY
FRAME
LOCK**

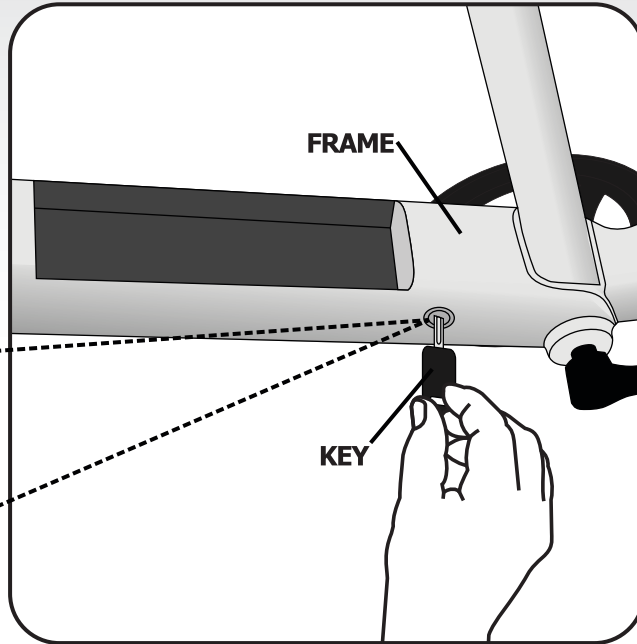
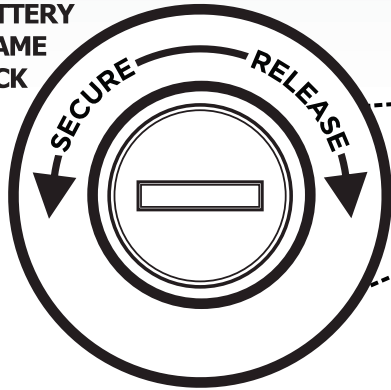

**BICYCLE
ASSEMBLY**

Battery Installation

Step 2: Insert the battery, bottom edge first and press into the frame. Make sure that battery is completely engaged and is sitting flush in the frame.

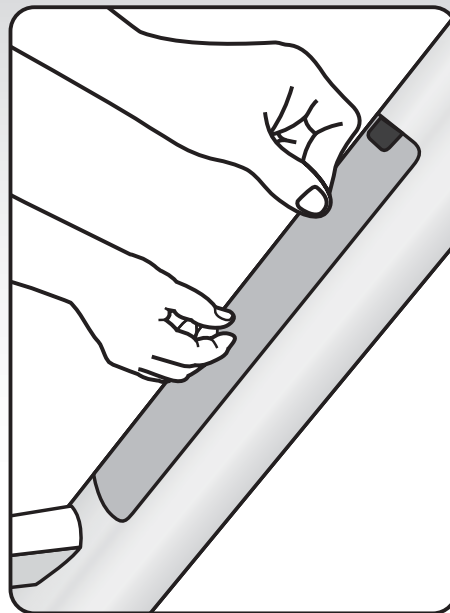
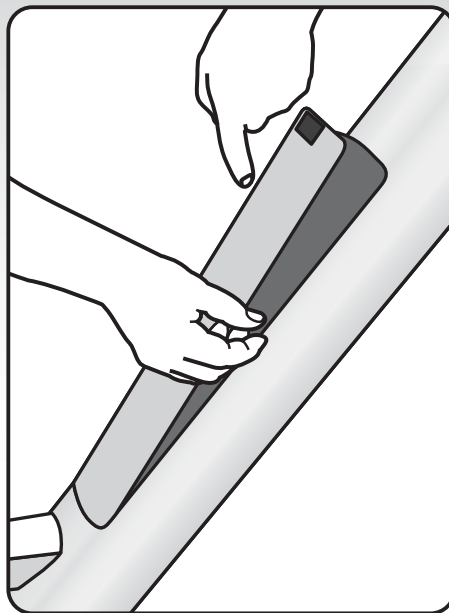

Step 3: Remove key and keep in safe place.

Battery Removal and Installation

WARNING! As with all electric appliances you must operate your E-Ride battery system with care. Do not store your charger or battery in any place where they could get wet or be subject to high heat. The storage area should be well ventilated.

Security: You are supplied with 2 keys to secure your battery to your bike. It is advisable to separate the keys and store one in a safe place. You can also unlock your battery, enabling you to remove it for security or to charge the battery when removed from the bike.

Battery Removal

Step 1: Insert the key into battery frame lock. Turn key to the right, clockwise, 180 degrees to "Release" battery frame lock. The battery is now ready to be removed.

BATTERY
FRAME
LOCK

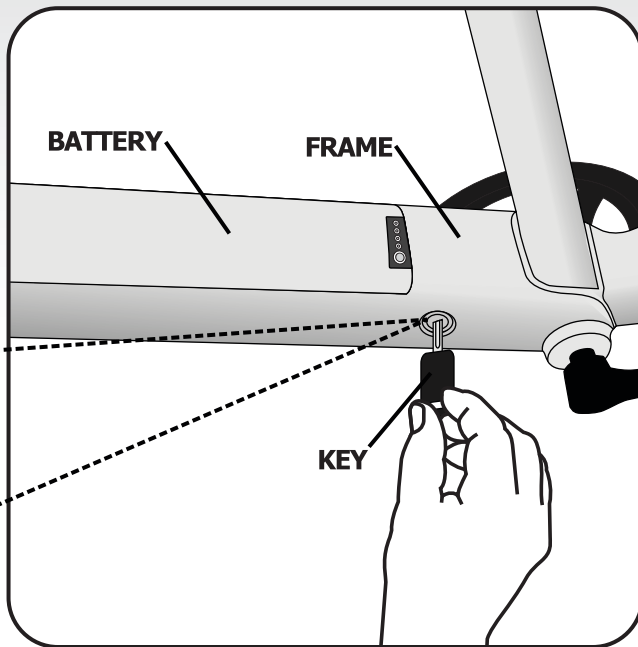

BICYCLE
ASSEMBLY



RIDE RIGHT
WEAR A HELMET WHEN YOU RIDE

Battery Removal

Step 2: Remove the battery from the frame by pulling gently from the top. You may now conveniently charge the battery while off the frame.

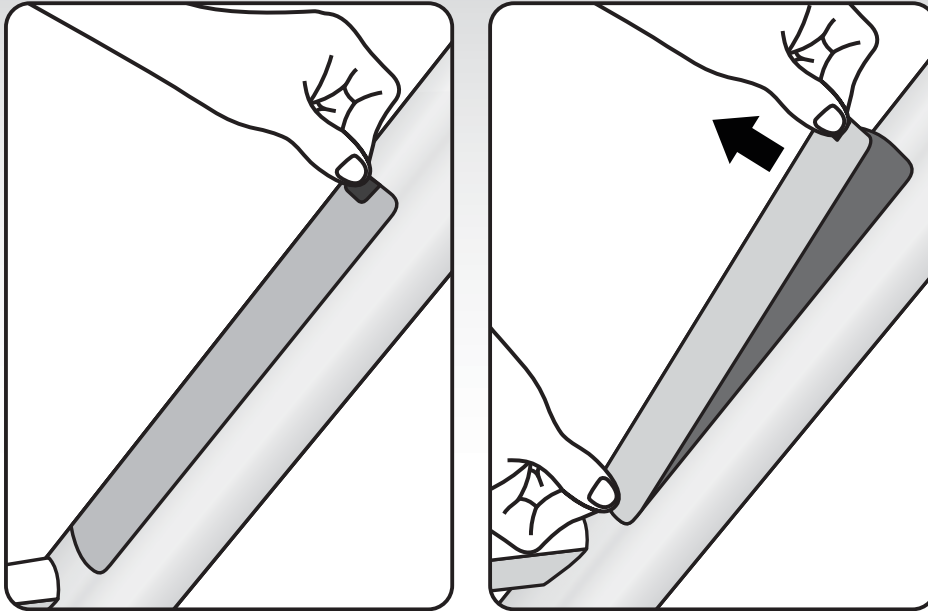

Step 3: Remove key and keep in safe place.

Battery Charging

⚠ WARNING! Only charge your battery with the charger supplied with your e bike. The charger is set to 100/240V. Using any other charger or voltage will void your warranty and could cause damage or cause injury.

Battery Charging on or off of Bicycle Frame

1. There is a charging port on the bike frame (Fig. 1), you can leave the battery in the bike and charge directly.
2. There is also a charging port on battery as shown in (Fig. 2), you can remove the battery from the bike and charge in another location. Make sure you charge battery in a well ventilated location.

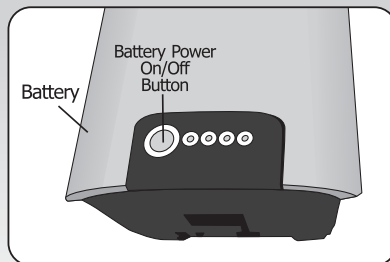

Note: Hold battery power button for 2 seconds to switch the battery to "on" or "off".

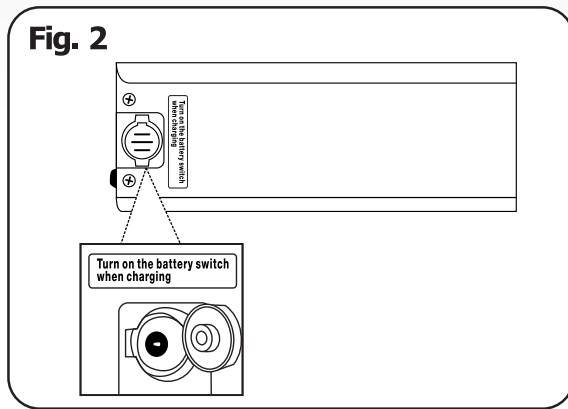
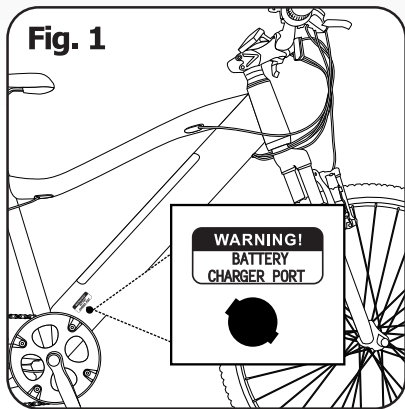

**BICYCLE
ASSEMBLY**



Battery Charging

Battery Charging on or off of Bicycle Frame (continued)

3. First plug in charger to power outlet. A green LED light on the charger should turn on when charger is receiving power. If no green LED light turns on, re-check connection to power outlet.
4. Connect female end of charger provided to the E-Ride bicycle frame charging port or the charging port on battery. When battery charger is connected, a Red LED light will show on battery charger indicating that the battery has started charging.

Charger



Battery Charging Ports

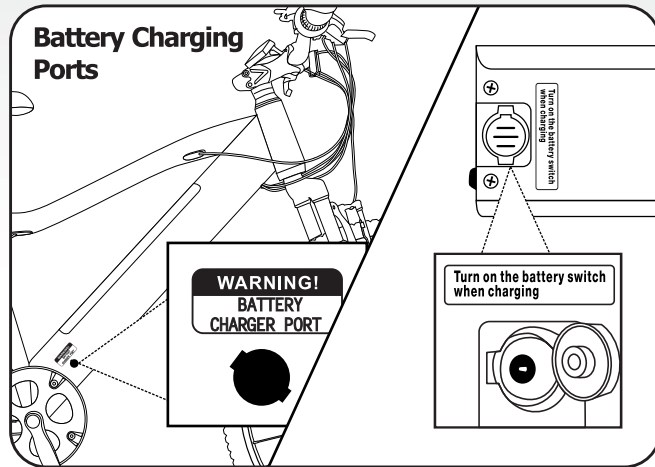

Battery Charging

Battery Charging on or off of Bicycle Frame (continued)

5. You can leave the battery charging. The battery will stop charging by itself when it has reached full charge. It is not recommended to leave your battery charging for any considerable time over what is required.
6. To fully charge your battery will take 4 hours.
7. Once fully charged, the LED light on the charger switches back to GREEN, indicating the battery is fully charged and will stay green. When fully charged, all 3 indicator lights on your battery will light GREEN and will go down as the power is depleted. When the first indicator lights red, the battery needs to be charged. Double check battery charge level by quickly pressing the On/Off button next to the battery indicator lights. **Note:** The battery must be already switched on to do this.

NOTE: When stored and not in use, remove the battery and store in a cool, dry place, charging periodically as the battery will loose power over time while not in use. Failure to periodically charge the battery will cause battery failure that is un-repairable.

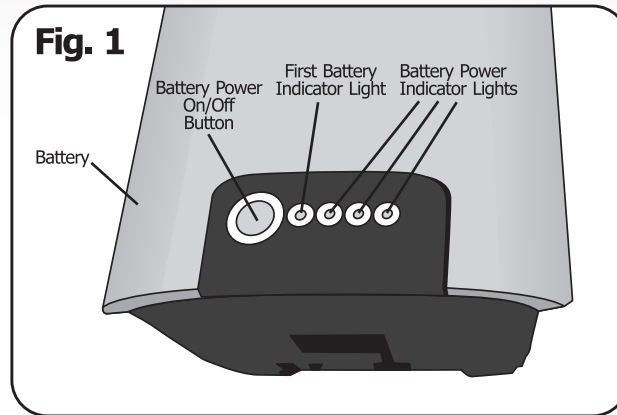

**BICYCLE
ASSEMBLY**

Battery Charging Rules to Follow

1. Do not cover charger with any material of substance that may restrict airflow to the charger. The charger needs to 'Breathe' to keep cool.
2. Charging your battery each time you use it, no matter how far the trip, will prolong the life of the battery.
3. DO NOT leave the battery discharged for long periods.
4. Never open the charger or change settings on charger.

NOTE: Any figures quoted regarding battery performance or distances which can be obtained per single charge are based on standard test conditions. Diverse terrain and rider weight will of course produce varying results from those stated.

Using Battery Charger

- Connect the charger directly to a power source. Never use extension cords.
 - Do not use for any batteries other than those supplied with your Hyper e-Ride Electric Bike.
 - Avoid dropping the Charger as this may damage the sensitive electronics within the casing.
 - The charger is designed for indoor use only. Do not expose it to rain or snow.
 - Using other types of batteries may burst, causing personal injury and damage.
 - Do not incinerate, disassemble or short circuit batteries.
 - If the performance of the battery decreases substantially, it is likely time to replace it.
 - Store the charger in a cool and dry place when not in use.
 - Disconnect the charger before making or breaking the connections to the battery;
- WARNING:** Explosive gases. Keep away from flames and sparks. Provide adequate ventilation during charging.
- During charging, the battery must be placed in a well ventilated area.
 - Keep all electrical appliances out of reach of children.
 - This charger is not intended for use by children or people with reduced physical ability. Children should not play with the appliance.

NOTE: This product must not be disposed of with the domestic waste. This product must be disposed of at an authorized place for recycling of electrical and electronic appliances.

Using Electric Pedal Assist Controller

1. **ON/OFF Button** - With battery frame lock turned to "Secure" first, then press down the On/Off button on controller to turn controller "On". The LEDs on the Controller will come on.
2. **Assist Level Control Button** – Press to change pedal assist levels to Low, Med and High.
3. **Battery Power Indicator Lights** - These lights are red and change as the rider uses the battery power. When the first battery indicator light flashes the battery needs to be charged.
4. **Power Indicator Lights** - As you ride up a hill the power indicator drops down showing increased resistance levels, but once back on level ground the indicator lights will return to a more accurate position of available power levels.
5. **6km Walking Mode Button** - This function allows you to push your bike effortlessly over steep ridges or hills with assistance from the electric motor. You can activate this function by holding down this button.

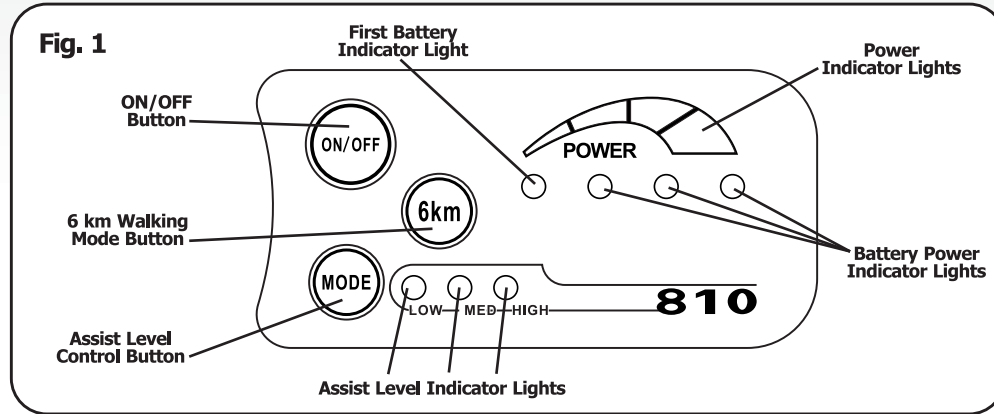

NOTE: The controller is fitted to the left side of the handlebar.



**BICYCLE
ASSEMBLY**

23

PAGE



Electric Powered Pedal Assist Motor

Rules of Electric Motor

1. Do not soak electric motor in water, this can cause damage to electric motor and void the factory warranty.
2. Do not open the electric motor yourself, this will void the factory warranty.
3. Only use controller and battery provided with this electric motor.
4. Do not over-power the motor, e.g. using a rated 48V battery
5. Do not lubricate the electric motor.

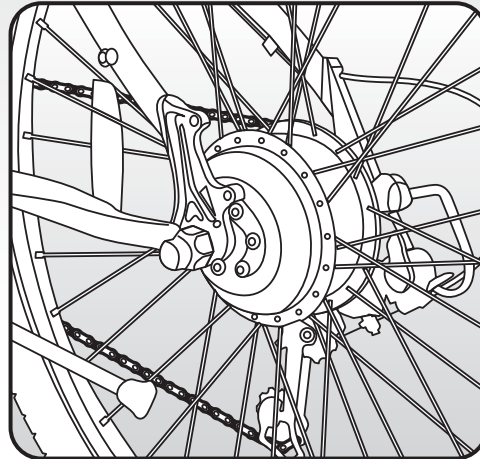

Electric Motor Specifications

Rated Voltage	36 Volts
Rated Power	250 Watts
Rated Speed	20 MPH
Efficiency	≥80%

NOTE: The motor is part of the real wheel assembly.

Replacement Batteries & Chargers

Replacement batteries and chargers are available and can be purchased separately. Please call our Customer Service Department at 866-204-9737 or 866-20-HYPER.

Electric Powered Pedal Assist Motor - Troubleshooting

Problem	Check	Action
Low Speed	Battery Power	Charge Battery
	Tire Pressure	Inflate tire to proper pressure
	Flat Tire	Replace Tire or Tube
	Overloaded	Do Not Overload Bicycle
Electric motor not working, power indicator not on	Every Plug	1. Ensure every plug is connected
		2. Check sensor on bottom bracket is in place
		3. Contact Helpline 866-204-9737
Battery Power ON, Electric Motor doesn't work	Loose wiring or connection	1. Check wiring and connections
		2. Check sensor on bottom bracket is in place
		3. Contact Helpline 866-204-9737
Reduced Battery Performance	Is the battery fully charged?	If battery not fully charged recharge battery fully
Charger not fully charging battery	Does the Red charger light stay on while charging?	If charger Red Light not on while charging replace charger
Low Battery Power	Charger works correctly?	Replace Battery
Brakes loose, no stopping power	Brake cable tension or worn brake shoes	Take to Authorized Bicycle service center

NOTE: Replacement batteries and chargers are available and can be purchased separately. Please call our Customer Service Department at 866-204-9737 or 866-20-HYPER.



**BICYCLE
ASSEMBLY**



BICYCLE ASSEMBLY

Bicycle Assembly

REFLECTORS

Your bicycle is supplied with one front (white), one rear (red), two wheel (white), and two pedal (orange) reflectors. These are an important safety and legal requirement, and should remain securely fitted and in good, clean conditions at all times. Periodically, inspect all reflectors, brackets and mounting hardware for signs of wear or damage. Replace immediately if damage is found.

(Front Reflector Bracket Installation)

NOTICE: It is important to check and adjust the position of the reflectors as you assemble your bike. The reflectors must always be vertical (perpendicular to the ground) and pointed toward the front and rear of the bike. Please make sure that the adjustment is correct as a final step in the assembly of your bike.

Attaching hardware to the handlebars.

With the white reflector facing forward wrap the rear end of the reflector bracket around the handlebar(A). Once the bracket is in the correct position, and the fastening nut is in place underneath the bracket, thread the screw down through the top of the bracket. Tighten screw firmly with screwdriver(B).

Reflectors

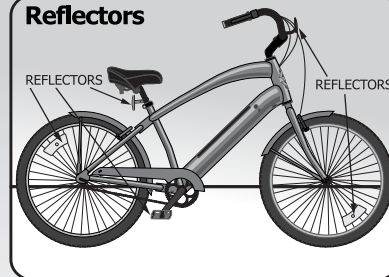

Handlebar Reflector Diagram A

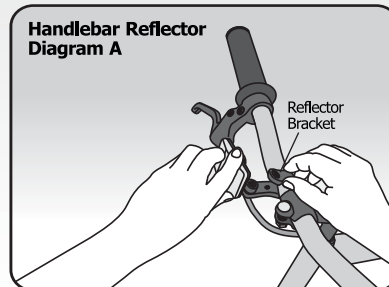

Handlebar Reflector Diagram B

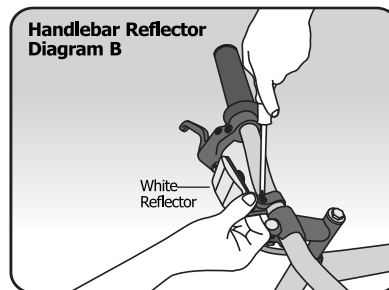

Rear Reflector Installation

1. Put the seat post mounted rear reflector in the correct position by loosening the screws of the rear reflector bracket.
2. Make sure the rear reflector is vertical and points straight toward the rear of the bicycle.
3. Make sure there are at least 3 in, (7.6 cm) of clearance between the top of the seat and the top of the red rear reflector.

Operation and Maintenance

⚠ WARNING: For your own safety, do not ride the bicycle if the reflectors are incorrectly installed, damaged, or missing. Make sure the front and rear reflectors are vertical. Do not allow the visibility of the reflectors to be blocked by clothing or other articles. Dirty reflectors do not work well. Clean the reflectors, as necessary, with soap and a damp cloth.

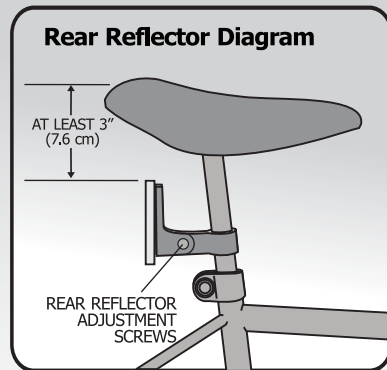



BICYCLE ASSEMBLY

INSTALL PEDALS

All pedals have "L" or "R" stamped on the threaded spindle of each pedal.

1. Thread the pedal marked "R" clockwise into the right or chain wheel side of the crank arm.
2. Thread the pedal marked "L" counter-clockwise into the left side of the crank arm.

NOTE: Hand thread pedals into position without use of a wrench to ensure threads are not crossed. Damage to crank arm will result from crossed threads. When tightening with a wrench, make sure each spindle is firmly seated against the crank arm. If jaws of wrench are too thick, they may prevent proper tightening of pedal spindle against crank arm.

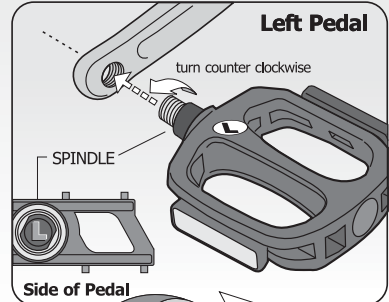
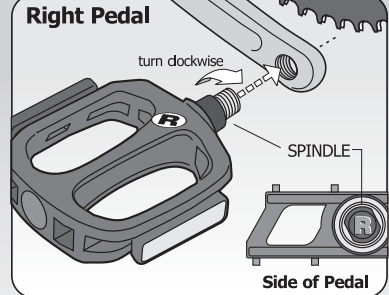

INSTALL SADDLE

1. Insert the seat post into bicycle frame tube with small Swaged end up.

NOTE: Seat post must be inserted at least to the minimum insertion mark stamped on the lower part of the post. If no minimum insertion mark can be found, make sure at least 3 in. (7.6 cm) of the post is inside the bicycle frame tube.

2. Tighten the seat post clamp nut securely. Recommended torque is 120 in./lbs, (13.6 Nm).
3. Loosen saddle clamp nuts so saddle clamp will fit down fully onto top swaged end of seat post.
4. Tighten seat post bolt. Recommended torque is 150 in./lbs, (17 Nm).

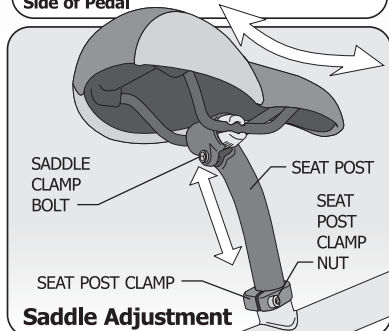

SADDLE HEIGHT (FIG A)

1. Turn crank to place it in its lowest position.
2. Place heel of foot on pedal with foot parallel to the ground.
3. Position saddle so that toe of other foot can touch the ground. Saddle should also be parallel to the ground and aligned straight with the bicycle frame.
4. Tighten seat post bolt. Recommended torque is 150 in/lbs, (17 Nm).

NOTE: Seat post must be inserted at least to the minimum insertion mark stamped on the lower part of the post. If no minimum insertion mark can be found, make sure at least 3 in, (7.6 cm), of the post is inside the bicycle frame tube.



FIG A

FORWARDS AND BACKWARDS (FIG B)

1. Position crank arm parallel to the ground.
2. Place ball of foot on pedal with foot parallel to the ground.
3. Position the saddle so that an imaginary line drawn from the center of your knee to the pedal spindle is vertical. Some riders move the saddle slightly forward of this position.

NOTE: Saddle should be horizontal and perfectly aligned with the bicycle.

4. Tighten saddle clamp nuts securely.



FIG B

Please read and follow all directions in this manual.
Always wear a helmet when you ride.



**BICYCLE
ASSEMBLY**





BICYCLE ASSEMBLY

Handlebar and Stem

1. Assemble the stem to the fork: If necessary, assemble the stem to bolt (4), washer (5), and wedge nut (2) to the stem (1). Turn the stem bolt only four revolutions into the wedge nut.

Turn the stem bolt only four revolutions into the wedge nut (2). Point the stem toward the front of the bicycle and put it into the locknut (7). Put the stem at a comfortable height for the rider.

⚠ WARNING: To prevent steering system damage and possible loss of control, the "MIN-IN" (minimum insertion) mark on the stem must be inside the locknut.

Make sure you can not see the "MIN-IN" (minimum insertion) mark (3) on the stem above the locknut. Tighten the stem bolt just enough that the stem will not fall into the locknut.

2. Assemble the handlebar to the stem:
Put the handlebar (8) into the stem, but do not tighten the handlebar clamp (6) at this time. Align the stem with the front wheel and tighten the stem bolt.

3. Assemble the brake lever to the handlebar. Loosen the clamp screw of each brake lever. If necessary, move the handlebar to each side to install the brake levers put the brake levers on the handlebar with the brake lever for the rear brake on the right side of handlebar. Do not tighten the clamp screw of the brake levers at this time.

4. Tighten stem bolt and the handlebar clamp bolt:

⚠ WARNING: do not over tighten the stem bolt. Over tightening the stem bolt can damage the steering and cause loss of control. Make sure the stem is aligned with the front wheel and tighten stem bolt

Stem Diagram

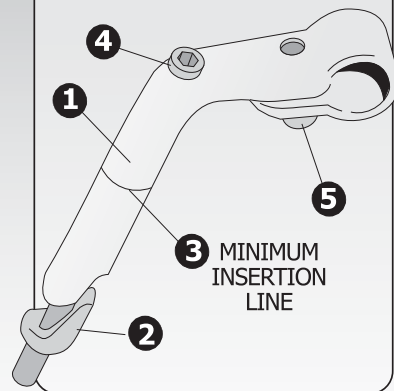

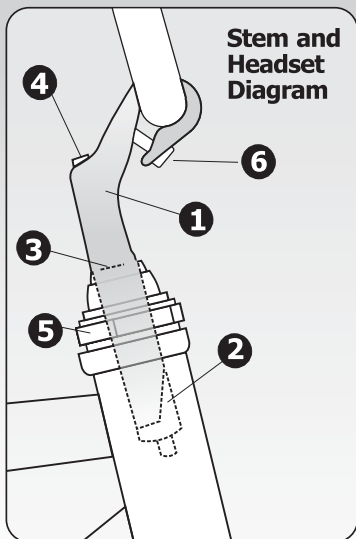

Handlebar and Stem (continued)

Put the handlebar in a comfortable position for the rider

! WARNING: if the handlebar clamp is not tight enough, the handlebar can slip in the stem. This can cause loss of control.

Tighten the bolt on the handlebar clamp.

5. Test the tightness of the stem: straddle the front wheel and hold between the legs.

Try to turn the front wheel by turning the handlebar. If the handlebar and stem turn with out turning the front wheel, realign the stem with the front wheel.

Tighten the bolt tighter than you did before (about half a revolution only at a time).

Do this test again, until the handlebar and stem do not turn without turning the wheel.

6. Test the tightness of the handlebar: Hold the bicycle stationary and try to move the ends of the handlebar forward or backward. If the handlebar moves, loosen the bolt of handlebar clamp. Put the handlebar in the correct position.

Tighten the bolts of the handlebar clamp tighter than before.
Repeat this test until the handlebar no longer moves inside the handlebar clamp.



Assemble the front wheel to the fork as shown:

- If the bicycle has a front caliper brake and the tire will not go down between the brake shoes (1), remove one brake shoe.

WARNING: If you remove a brake shoe to install the front wheel, return it to the correct position as written in the "Brake and Cable Adjustment" section.

- Make sure the tab of each security washer (2) is in the hole of the fork

NOTE: Some models have a front fork with a built in wheel retention feature. The security washers are not required and will not fit on a fork with this feature.

- Using the two axle nuts (3) with serrations, attach the front wheel.

WARNING: Do not use the nuts without serrations to attach the front wheel.

- Put the wheel in the center of the fork and tighten both nuts to the recommended torque of 21 ft-lbs, (28.5 Nm).

(Shown with Bike Sitting Upside-Down)

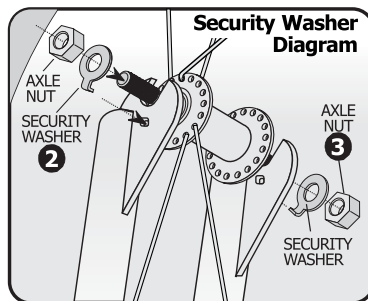
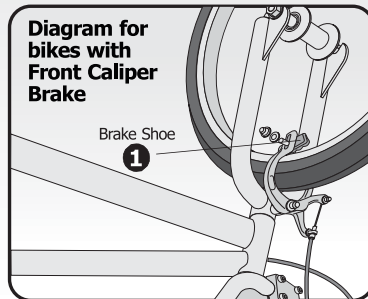
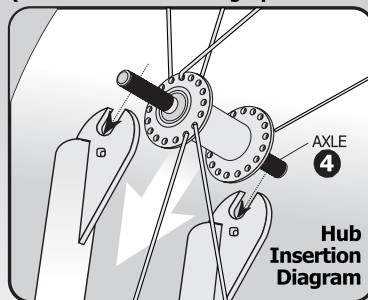

Hand Brake

A bicycle with hand brakes may have one hand lever which operates a rear brake, or two brake levers, one of which operates on the front wheel and the other on the rear wheel. It's important to your safety that you instinctively know which brake lever controls which brake on your bike. In most countries bikes are required to be set up with the right brake lever controlling the rear brake, and the left lever controlling the front brake.

NOTE: For most effective braking, use both brakes and apply them simultaneously.

WARNING: Sudden or excessive application of the front brake may pitch the rider over the handlebars, which may result in serious injury or death.

The braking action of bicycle hand brakes is a function of the friction between the brake shoes and wheel rim. To make sure that you have maximum friction available, keep your wheel rims and brake shoes clean and free of lubricants, waxes or polishes.

Make sure that your hands can reach and squeeze the brake levers comfortably. If your hands are too small to operate the levers comfortably, consult your dealer before riding the bike. The lever reach may be adjustable; or you may need a different brake lever design.

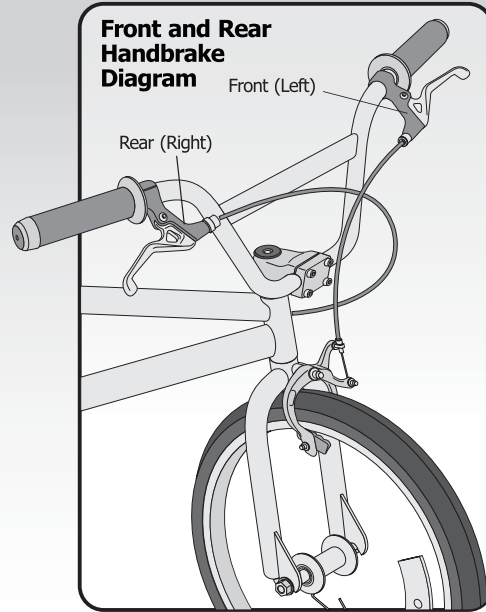

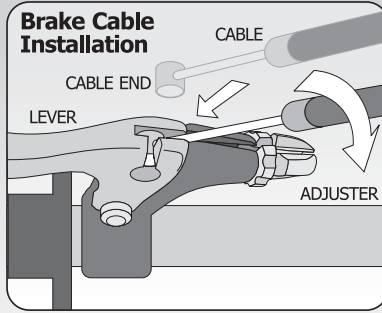

Brake Installation

- 1) Attach the upper cable to the brake lever. Ensure that the adjusting barrel is fully tightened in the brake lever.
- 2) Pull the link wire on the rear brake assembly until the brake shoes are touching the rim wall and tighten the brake bolt.
- 3) Ensure that the brake shoes are positioned evenly with the side surface of the rim.

Attaching the Front Brake Cable

(For Bicycles equipped with a Front Brake)

1. Open the brake lever and place the barrel end of the cable into the lever.
2. Feed brake cable through cable adjuster and through anchor bolt. Secure anchor bolt firmly.
3. Fasten brake caliper to fork by sliding brake mount bolt through center hole in fork. Secure brake mount bolt firmly.
4. Refer to the next section for Brake System Adjustments.

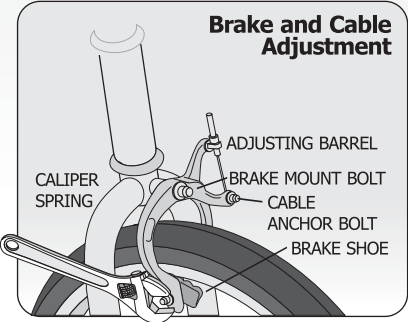

V-Brake

1. Disconnect the V-Brake lever arm, as shown in **Fig. 1**, to allow the front tire to pass between the V-brake pads when the wheel is installed. (1) Squeeze the two lever arms together by hand. (2) Use other hand to pull the guide pipe across and up to unhook from the left lever arm (3). This allows enough room for the wheel to be installed.

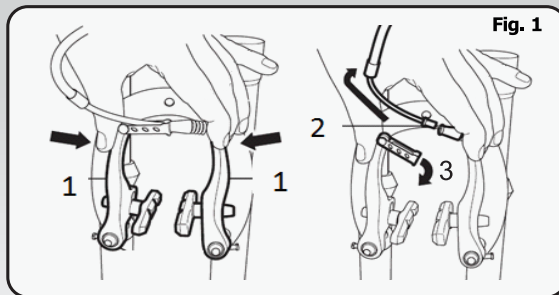

2. To insert the wheel carefully turn bike upside down so it rests securely on the saddle and handlebars. Loosen both of the wheels axle nuts and move security washers out.. Insert the wheel axle into the slots at the bottom of the forks. Make sure the security washers are in the hole of the fork and wheel is centered in the forks. Tighten both nuts to the recommended torque 21 ft-lbs, (28.5 Nm).

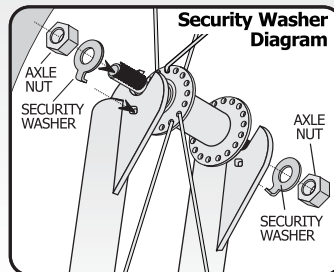
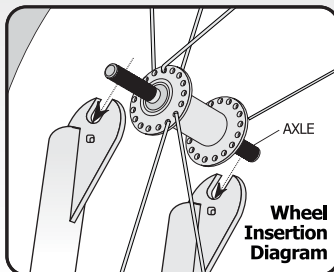

3. As shown in **Fig. 2** assemble the V-Brake by (1) squeezing by hand the two lever arms together. Using other hand locate the (5) guide pipe into retaining plate slot of the left lever arm. Once the guide pipe is in place release the two lever arms.

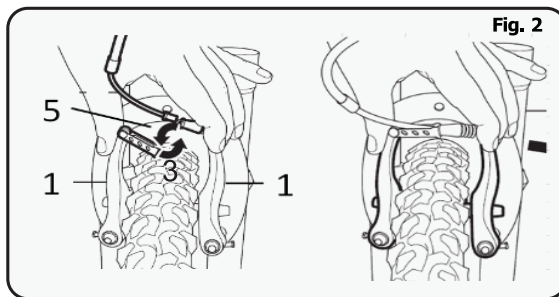

BICYCLE
ASSEMBLY



RIDE RIGHT
WEAR A HELMET WHEN YOU RIDE

The following sections describe final brake system adjustments required before riding. Determine which style you have and follow the instructions.

1. Check tightness of caliper brake mounting nut or cantilever mounting bolts (1):

Make sure each caliper brake mounting nut or cantilever mounting bolt is tightened securely.

2. Center brake shoes on rim:

If you have a cantilever brake, turn the cable anchor bolt (6) on the cantilever arm (4) to move the arm in or out so each brake shoe is the same distance from the rim (3). If you have a caliper brake, hit downward lightly on the return spring of the brake shoe (2) that is farther away from the rim. Make sure both ends of the return spring stay hooked around the inside edge or between the studs on the back of the caliper arms. Squeeze the brake lever two times. Do this step again, until both brake shoes are the same distance from the rim.

3. Put the brake shoes the correct distance from the rim(5):

Position each brake shoe 1/16 in, (1.6 mm) away from the rim. Turn the brake lever adjusting barrel or caliper brake adjusting barrel in or out to make the adjustment. If the brake shoes cannot be positioned the correct distance from the rim. Hold both brake shoes against the rim and loosen the cable anchor bolt (6).

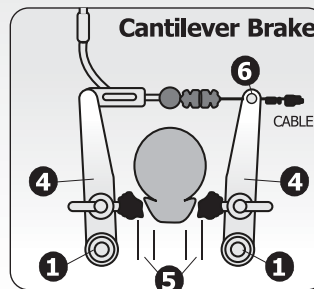
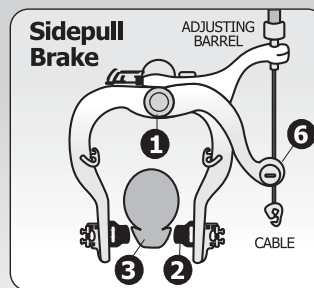

Brake System Adjustments

WARNING: You must adjust the front and rear brakes as written before you ride the bicycle

1. Put the brake shoes in the correct position:

Loosen the nut (1) of each brake shoe. Adjust each brake shoe so it is flat against the rim and aligned with the curve of the rim. Make sure each brake shoe does not rub the tire. If the surface of the brake shoes has arrows, make sure the arrows point toward the rear of the bicycle. Hold each brake shoe in position and tighten the nut.

2. Test the tightness of each brake shoe:

Try to move each brake shoe out of position. If a brake shoe moves, do Step 1 again, but tighten the nut tighter than before. Do this test again, until each brake shoe does not move.

3. Stretch the cable:

Hold both brake shoes against the rim. Loosen the cable clamp. Pull the cable tight and tighten the cable clamp

WARNING: Do not overtighten the cable clamp. Overtightening the cable clamp may cut the cable and cause injury to the rider or to others.

Squeeze each brake lever firmly 20 times. Hold both brake shoes against the rim and loosen the cable clamp. Pull the cable tight and tighten the cable clamp.

Brake Shoe

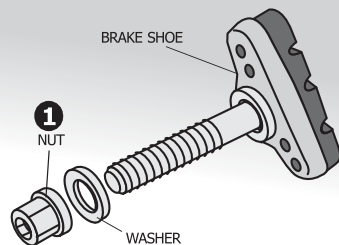

Brake Lever

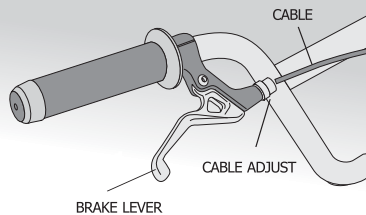

Pull or loosen the cable wire slightly. Tighten the cable clamp

 **WARNING: Do not overtighten the cable clamp.**
Overtightening the cable clamp may cut the cable and cause injury to the rider or to others.

Do Step 3 until the brake shoes are the correct distance from the rim.
Turn the locknut(s) against the brake lever and the caliper brake.

 **WARNING: Do not move the brake shoes away from a wheel rim that is not true (straight). This can cause the caliper brake to be less effective and unsafe. To allow safe adjustment of the caliper brake, have a bicycle service shop true the wheel.**

4. Check sheath position:

Make sure both ends of the sheath are fully recessed in the brake lever, sheath stops (if equipped) and brakes. If not, install sheath in correct position and do Step 3 again. Do this test again, until the sheath is in the correct position.

5. Test the tightness of the cable clamp:

Squeeze each brake lever with firm pressure. Make sure the cable does not move in the cable clamp. If the cable moves in the cable clamp, do Steps 3 and 4 again but tighten the cable clamp tighter than before. Do this test again, until the cable does not move in the cable clamp.

6. Adjust the brake lever reach so the distance from the grip is comfortable to the rider.

Turn the adjustment screw (if equipped) to change the distance of the brake lever from the grip. Make sure the back of each grip is no more than 3 ½ in, (9 cm) from the front of each brake lever.

7. Test the travel of each brake lever:

Squeeze each brake lever with strong pressure. If the brake lever touches the grip, do Steps 1 through 7 again.

 **WARNING: After you do Steps 1 through 7 again, if either brake lever touches the grip or does not work well, have a bicycle service shop repair or adjust the caliper or cantilever brakes.**

Reducing Caliper Brake Noise (Caliper Brake Only)

It is common for caliper brakes to make noise or "squeak" when in use. This noise does not Normally indicate a brake problem. Following the instructions below may reduce the noise:

Make sure the caliper brakes are adjusted correctly. Using a small adjustable wrench, bend each caliper arm so the front edge of each brake shoe is the first part to touch the rim.

 **WARNING: Bend each caliper only a small amount. If you bend the caliper arm too far, the caliper brake can be damaged and performance of the caliper brake reduced.**

Brake System Operation

Operate the brakes as follows:

Squeeze the brake lever on the handlebar. The brake lever pulls on a cable that is attached to the brake. The brake squeezes the rim between two brake shoes. **Note:** applying the brakes will disengage the power assist function.

Operate the brakes by slowly and continuously squeezing both brake levers until you feel the braking action. Make a habit of always using both brakes to stop the bicycle. You will stop in the shortest distance by using both brakes.



**BICYCLE
ASSEMBLY**



ADJUSTMENT



BICYCLE ASSEMBLY

Rear Derailleur Adjustment

The Low limit screw determines how far the rear derailleur will travel toward the wheel of the bicycle, while the High limit screw determines how far the cage will travel toward the frame.

1. Shift the rear shifter to the largest number indicated, disconnect the rear derailleur cable from the cable anchor bolt and place the chain on the smallest sprocket.
2. Adjust the High limit screw so the chain and the smallest sprocket are lined up vertically. Remove any slack in the cable by pulling it taut, then re-connect the cable and tighten the cable anchor bolt securely.
3. Shift up through the gears making sure that each gear is achieved quietly and without hesitation.

If noise occurs, use the barrel adjuster clockwise will decrease cable tension and allow the derailleur cage to move farther away from the bicycle in small increments. Turning counter-clockwise will increase cable tension and bring the cage closer to the bicycle. This will micro-adjust the positioning of the derailleur cage in relation to the freewheel. Simply put; turn the barrel adjuster the direction you want the chain to go.

4. Shift the chain onto the largest sprocket; adjust the low limit screw so the chain and the largest cog are lined up vertically. If you are unable to get the chain to the largest cog, turning the Low limit screw counter-clockwise will enable the chain to move towards the wheel.
5. Shift through the gears ensuring each gear is achieved quietly and without hesitation.

NOTE: It may take several adjustments to achieve the desired positioning. Please refer to the troubleshooting section for more assistance.

Rear Derailleur Diagram (Rear View)

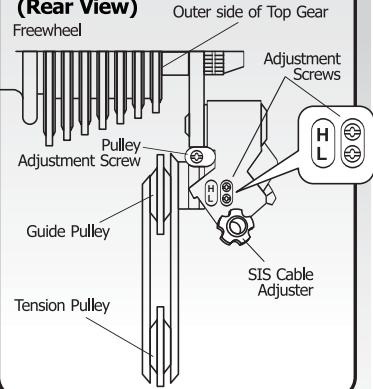

Rear Derailleur Diagram (Side View)

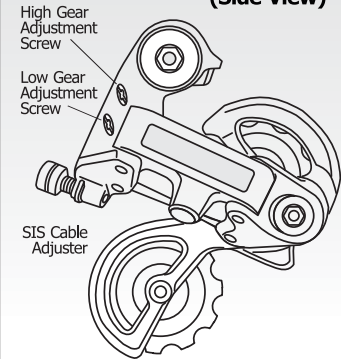



WARNING: If you do not obey the following instructions, injury to the rider or to others can occur:

Before you ride the bicycle for the first time, check and adjust the brakes as written in the "Adjustments" section. Then test the brakes and practice using them at low speed in a large and level area that is free of obstruction.

When correctly used, the brake system is very effective. But, if you apply the front brake too strongly, you can be thrown off the bicycle. Make a habit of always using both brakes to stop the bicycle.

Always try to brake while going in a straight line. Apply brakes earlier in the following conditions: wet pavement, sand, gravel, leaves, or if you need to brake while turning. To reduce the chance of skidding apply brakes intermittently.

If the rims are wet, start to brake earlier than normal because a longer distance to stop the bicycle will be necessary.

Be careful when riding downhill or at a high speed because as your speed increases, a longer distance to stop the bicycle will be necessary. Slow for curves because too much speed can force you to make a turn too wide.

Keep wax, oil, grease, etc. off the rims and the brake shoes. These lubricants will reduce brake performance and a longer distance to stop the bicycle will be necessary.

Check and adjust the brakes the first time they do not stop the bicycle quickly and smoothly, do not stop the bicycle as well as they have in the past, or if either brake lever can touch the grip.

Familiarize yourself with the assisted power levels and speed of your e-Bike before riding on roads or in traffic.



BICYCLE ASSEMBLY





The tire valve allows air to enter the tire's inner tube under pressure, but doesn't let it back out unless you want it to.

There are primarily two kinds of bicycle tube valves the Schraeder Valve and the Presta Valve. The bicycle pump you use must have the fitting appropriate to the valve stems on your bicycle.

The Schraeder (Shown) is like the valve on a car tire. To inflate a Schraeder valve tube, just remove the valve cap and push the air hose or pump fitting onto the end of the valve stem. To let air out of a Schraeder valve, depress the pin in the end of the valve stem with the end of a key or other appropriate object.

The Presta (Shown) has a narrower diameter and is only found on bicycle tires. To inflate a Presta valve tube using a Presta headed bicycle pump, remove the valve cap; unscrew (counterclockwise) the valve stem lock nut; and push down on the valve stem to free it up. Then push the pump head on to the valve head, and inflate. To inflate a Presta valve with a gas station air hose, you'll need a Presta adapter (available at your bike shop) which screws on to the valve stem once you've freed up the valve. The adapter fits the end of the air hose fitting. To let air out of a Presta valve, open up the valve stem lock nut and depress the valve stem. Always close the valve stem lock after inflation.

Schraeder Valve

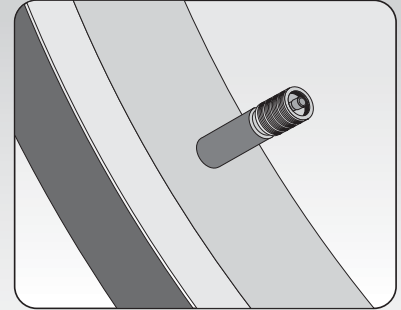

Presta Valve

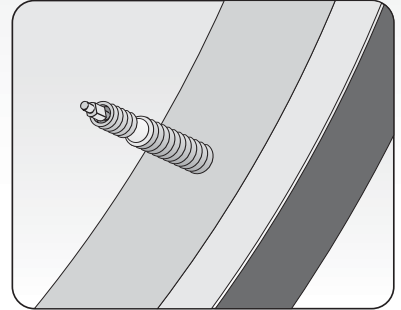

Tires

Maintenance Frequently check the tire inflation pressure because all tires lose air slowly over time. For extended storage, keep the weight of the bicycle off the tires.

 **WARNING: Do not ride or sit on the bicycle if either inner tube is under inflated. This can damage the tire and inner tube. Do not use unregulated air hoses to inflate the inner tubes. An unregulated hose can suddenly over inflate bicycle tires and cause them to burst.**

Use a hand or a foot pump to inflate the inner tubes. The correct inflation pressure is shown on the tire sidewall.

Before adding air to any tire, make sure the edge of the tire (the bead) is the same distance from the rim, all around the rim, on both sides of the tire. If the tire does not appear to be seated correctly, release air from the inner tube until you can push the bead of the tire into the rim where necessary. Add air slowly and stop frequently to check the tire sealing and the pressure, until you reach the correct inflation pressure as indicated on the tire sidewall. **Replace worn or defective tires and inner tubes.**



**BICYCLE
ASSEMBLY**

43

PAGE





TIRE REMOVAL

1. Let the air out of the tire by depressing the valve core (the little pin in the center of the valve stem opening).
2. Stand the wheel up on a firm surface with the valve stem on the bottom and grasp the upper part of the tire with both hands. Try to roll the tire off the far side of the rim.
3. Separate the tire bead from the sides of the rim by pressing with your thumbs. Work your way around the tire on both sides to be sure that the beads of the tire are not sticking to the rim. (Figure A)
4. With the wheel standing as in Figure B, use bicycle tire tools or spoon handles with rounded ends (at least two - preferably three) to lift the bead on one side of the tire off the rim. Be careful not to pinch the inner tube between the tire tools and the tire bead or rim. Once you have got the bead off for about one fourth of the circumference of the tire using the tools, the rest can usually be pulled off by hand.
5. With the bead on one side of the tire completely off the rim, you can now pull the inner tube out from between the tire and rim everywhere except in the area of the valve stem.
6. It should now be easy to pull the tire the rest of the way off the rim. Start at the side of the wheel opposite the valve stem and simply lift the bead of the tire up over the side of the rim and pull it off.

FIGURE A
Press with thumbs to separate tire bead. Continue around entire rim until the bead is completely separated.

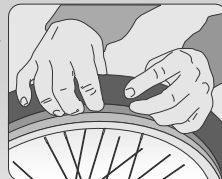

FIGURE B
Lift bead with spoons or tire tools.

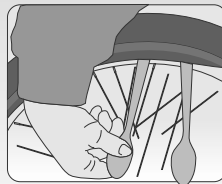

FIGURE C
Replace tire onto rim.

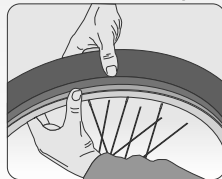

FIGURE D
Rim strip protects inner tube from spoke ends.

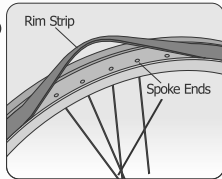

FIGURE E
Use thumb to press valve stem through hole in rim. Make certain valve stem is straight.



Repair and Service

WARNING: Inspect the bicycle frequently. Failure to inspect the bicycle and to make repairs or adjustments, as necessary can result in injury to the rider or to others. Make sure all parts are correctly assembled and adjusted as written in this manual and any "Special Instructions".

Immediately replace any damaged, missing, or badly worn parts.

Make sure all fasteners are correctly tightened as written in this manual and any "Special Instructions". Parts that are not tight enough can be lost or operate poorly. Overtightened parts can be damaged. Make sure any replacement fasteners are the correct size and type.

If your frame is aluminum, inspect the bicycle frame carefully and frequently. Aluminum frames can develop very small cracks due to stress, severe shocks, etc. If you see any small cracks, stop riding the bicycle. Have the frame inspected by a qualified professional at a bicycle service shop before riding the bicycle again.

NOTE: Have a bicycle service shop make any repairs or adjustments for which you do not have the correct tools or if the instructions in this manual or any "Special Instructions" are not sufficient for you.

Rear Wheel/Chain Adjustment

Maintenance: The chain must be at the correct tightness. If too tight, the bicycle will be difficult to pedal. If too loose, the chain can come off the sprockets.

WARNING: The chain must remain on the sprockets. If the chain comes off the sprockets, the coaster brake will not operate.

When the chain (1) is at the correct tightness, you can pull it 1/2 in, (1.27 cm), (2) away from a straightedge (3) as shown.

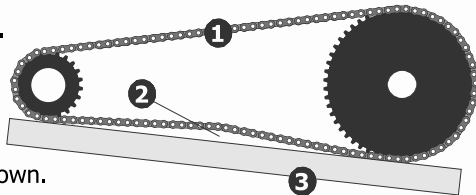



Inspection of Bearings

Maintenance: Frequently check the bearings of the bicycle. Have a bicycle service shop lubricate the bearings once a year or any time they do not pass the following tests.

Head Tube Bearings: The fork should turn freely and smoothly at all times. With the front wheel off the ground, you should not be able to move the fork up, down, or side-to-side in the head tube.

Crank Bearings: The crank should turn freely and smoothly at all times and the front sprockets should not be loose on the crank. You should not be able to move the pedal end of the crank from side-to-side.

Wheel Bearings: Lift each end of the bicycle off the ground and slowly spin the raised wheel by hand. The bearings are correctly adjusted if:

The wheel spins freely and easily. The weight of the spoke reflector, when you put it toward the front or rear of the bicycle, causes the wheel to spin back and forth several times. There is no side-to-side movement at the wheel rim when you push it to the side with light force.

Lubrication / Maintenance

⚠ WARNING: Do not over lubricate. If oil gets on the wheel rims or the brake shoes, it will reduce brake performance and a longer distance to stop the bicycle will be necessary. Injury to the rider or to others can occur.

The chain can throw excess oil onto the wheel rim. Wipe excess oil off the chain.

Keep all oil off the surfaces of the pedals where your feet rest.

46 Using soap and hot water, wash all oil off the wheel rims, the brake shoes, the pedals, and the tires. Rinse with clean water and dry completely before you ride the bicycle.

Using a light machine oil (20W) and the following guidelines, lubricate the bicycle:

What	When	How
Brake Levers	every six months	Put one drop of oil on the pivot point of each brake lever
Caliper Brakes	every six months	Put one drop of oil on the pivot point of each caliper brake
Brake Cables	every six months	Put four drops of oil into both ends of each cable. Allow the oil to soak back along the cable wire.
Pedals	every six months	Put four drops of oil where each pedal axle goes into the pedal.
Chain	every six months	Put one drop of oil on each roller of the chain. Wipe all excess oil off the chain.



**BICYCLE
ASSEMBLY**



ADJUSTMENT

Repair and Service

WHEELS

Wheel Inspection

It is most important that wheels are kept in top condition. Properly maintaining your bicycle's wheels will help braking performance and stability when riding. Be aware of the following potential problems:

Dirty or greasy rims:

Caution: These can render your brakes ineffective. Do not clean them with oily or greasy materials. When cleaning, use a clean rag or wash with soapy water, rinse and air dry. Don't ride while they're wet. When lubricating your bicycle, don't get oil on the rim braking surfaces.

Wheels not straight:

Lift each wheel off the ground and spin them to see if they are crooked or out of round. If wheels are not straight, they will need to be adjusted. This is quite difficult and is best left to a bicycle specialist.

Broken or loose spokes:

Check that all spokes are tight and that none are missing or damaged.
Caution: Such damage can result in severe instability and possibly an accident if not corrected. Again, bicycle specialist best handles spoke repairs.

Loose hub bearings:

Lift each wheel off the ground and try to move the wheel from side to side.
Caution: If there is movement between the axle and the hub, do not ride the bicycle. Adjustment is required.

Axle nuts:

Check that these are tight before each ride.

Lubrication and Adjustment - One Piece Cranks

To adjust the free play in a one piece type bottom bracket, loosen the locknut on the left side by turning it clockwise and tighten the adjusting cone counter-clockwise using a screwdriver in the slot. When correctly adjusted, re-tighten the locknut counter-clockwise.

- 1) Remove the chain from the chain wheel.
- 2) Remove the left side locknut by turning it clockwise and remove the key lock washer.
- 3) Remove the adjusting cone by turning it clockwise with a screwdriver.
- 4) Remove the left ball retainer, slide the crank assembly out of the frame to the right and remove the right ball retainer. Clean and inspect all bearing surfaces and ball retainers, and replace any damaged parts. Pack the ball bearings retainers with grease, then re-assemble in the reverse of the above procedure.

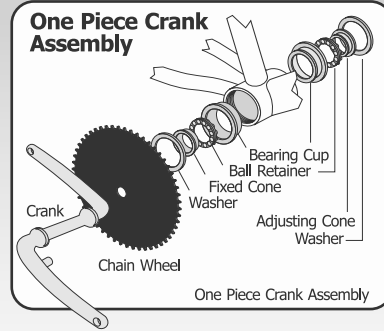

Adjustment - 3 Piece Cranks

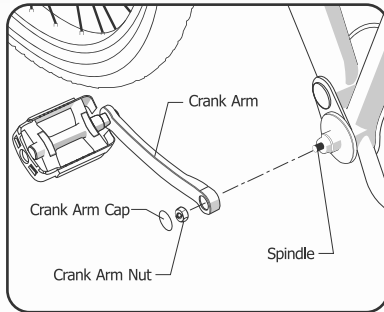

Maintenance: Both **Crank Arms** were tightened to the **Spindle** at the factory. After riding the bicycle the first few times make sure the crank arms have not loosened. If either **Crank Arm** has loosened during this "break-in" period re-tighten the **Crank Arm Nut** or have it tightened by a bicycle service shop. Frequently check the tightness of the crank arms. If loose tighten both **Crank Arm Nuts** or have them tightened by a bicycle service shop.

WARNING! If you ride the bicycle with a loose crank arm the crank arm may fall off while riding causing injury. A loose crank arm may also cause damage to spindle.

NOTE: Torque Crank Arm Nut to 450 - 500 in-lbs, (56.5 Nm).

Note: the right twist shifter operates the rear gears and the left shifter operates the front gears.

Twist Shifter

Note: Operate by rotating twist shifter backwards and forwards.

Right lever (Rear)

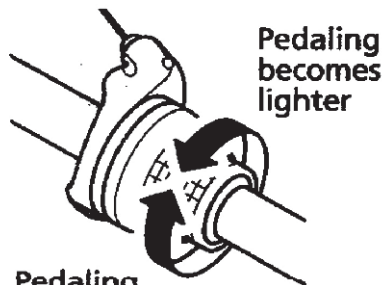

Pedaling becomes lighter

Pedaling becomes heavier



To select a **Higher Gear Rotate Upwards** or away from yourself.

To select a **Lower Gear Rotate Downwards** or towards yourself.

Notice the numbers align with an indicator showing you which gear is selected.

! **Important: Do not change gears while the bike is stationary. Always pedal the bicycle when changing gears.**

Front Fender Installation

The front and rear fenders need to be attached to your bicycle before riding. All the hardware is in place, you will only have to loosen the hardware to mount the fenders and re-tighten. Check to assure that the fender is centered between the forks and not rubbing, or close to rubbing the tire anywhere. Use a wrench to tighten the nut at the top of the fork, the tighten the screws using a screwdriver on both sides of the fork legs at the bottom. The fender should be secure and not rub the tire when spun.

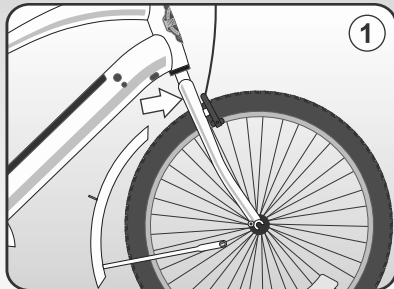

1 Remove the nut at the top rear of the fork as indicated by the arrow. Place the front fender over the wheel and between the fork legs.

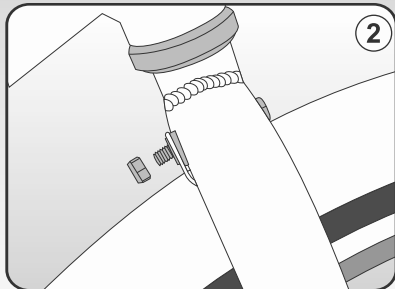

2 Slide the mounting tab on the top of the fender over the bolt where the nut was previously removed.

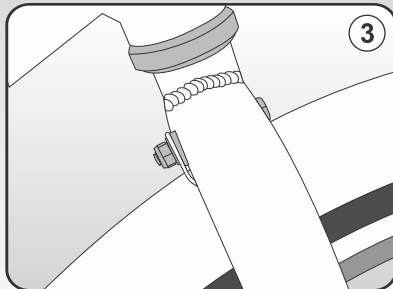

3 Replace the nut and hand tighten

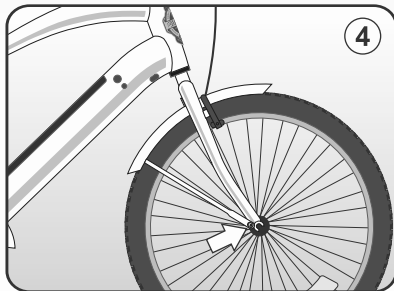

4 Remove the screws at the bottom of the fork legs, behind the axle nut on each side of the fork legs.

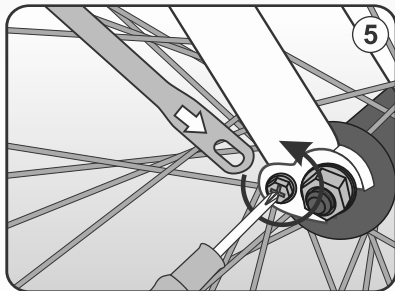

5 Position the fender support rail on the outside of the fork leg and line up the slot in the rail with the hole in the fork leg. Reinsert and hand tighten the screw, repeat this for the other side.

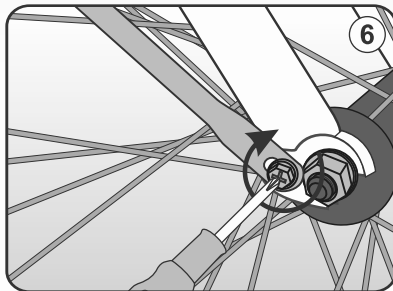

6 Replace the nut and hand tighten



BICYCLE
ASSEMBLY

WARRANTY



NEW OWNER



RIDE RIGHT
WEAR A HELMET WHEN YOU RIDE

HYPER BICYCLES WARRANTY and Policy on Replacement Procedures and Responsibilities

Your purchase includes the following warranty which is in lieu of all other expressed warranties. This warranty is extended only to the initial consumer purchaser. No warranty registration is required. This warranty gives you specific legal rights and you may have other rights which vary from state to state.

Frame

The entire frame is guaranteed against faulty materials and workmanship for a period of Two Years for the initial consumer purchaser of the bicycle, subject to the conditions of the warranty listed below. If frame failure should occur due to faulty materials or workmanship during the guarantee period, the frame will be replaced. For frame replacement under this Hyper Bicycles Warranty, contact us with the Model and serial number, date of purchase, store where purchased, and the nature of the failure, at service@hyperbicycles.com.

Parts

All other parts of the unit except Normal Wear Parts are warranted against defective materials and workmanship for a period of 1 year from the date of purchase by the initial consumer purchaser, subject to the Terms and Conditions of the warranty listed below. If failure of any part should occur during the warranty period the part will be replaced if the failure was due to faulty materials or workmanship. There will be no cost to you except possibly for shipping and handling. Normal Wear Parts are defined as grips, tires, tubes, cables and saddle covering. These parts are warranted to be free from defects in material and workmanship as delivered with the product. Any claim for repair or replacement of Normal Wear Products must be made within thirty (30) days of the date of purchase. The warranty does not cover normal wear and tear, improper assembly or maintenance, or installation of parts or accessories not originally intended or compatible with the bicycle as sold. The warranty does not apply to damage or failure due to accident, abuse, misuse, neglect, or theft. Claims involving these issues will not be honored.

Electrical Components

Your Hyper e-Bike includes a battery, controller and motor. These components require a higher level of care than that of a standard, non-power assisted bicycle. Your e-Bike should always be stored in a covered, dry location. The battery should be charged and stored per the instructions in your manual. Your e-Bike is not designed to be ridden in wet conditions or to be made very wet during cleaning. *Riding in wet conditions at the speeds attainable on your e-Bike is not safe!* Always take care to isolate the electrical components from moisture. Care must also be taken in the general treatment of your e-Bike. It cannot be dropped on the ground or treated as roughly as you could a standard bicycle. Your warranty will be voided if there is any evidence of the above inappropriate treatment of this product.

Conditions of Warranty

1. Your bicycle has been designed for general transportation and recreational use but has not been designed to withstand abuse associated with stunting and jumping. This warranty ceases when you rent, sell, or give away the bicycle, ride with more than one person, or use the bicycle for stunting or jumping.
2. This warranty does not cover ordinary wear and tear or anything you break accidentally or deliberately.
3. It is the responsibility of the individual consumer purchaser to assure that all parts included in the factory-sealed carton are properly installed, all functional parts are initially adjusted properly, and subsequent normal maintenance services and adjustments necessary to keep the bicycle in good operating condition are properly made. This warranty does not apply to damage due to improper installation of parts or failure to properly maintain or adjust the bicycle. NOTICE: Bicycle specifications subject to change without notice.
4. This bicycle was designed to be assembled and operated solely in accordance with the assembly instructions. If the purchaser and/or user alters, changes or modifies any of the components, the design or any original manufacturing specifications of the bicycle, all manufacturing warranties are null and void and Hyper Bicycles and any of its affiliated companies or manufacturing sources will not be liable for any damages, injuries or problems of any kind whatsoever. If you have any questions regarding this policy, please contact our warranty department.

PURCHASE RECORD CARD

IMPORTANT NOTICE

- ⚠ Fill in immediately and send in as a record of your purchase.
- ⚠ Record Serial Number and retain in designated spot in front of this Manual.

Owner's Name: _____

Address: _____

Date Purchased: _____ Place of Purchase: _____

Model Name: _____

Wheel Size: _____ Color: _____

Serial Number: _____

(ALSO RECORD AND RETAIN SERIAL NUMBER IN DESIGNATED SPOT IN FRONT OF THIS MANUAL)

SERIAL NUMBER LOCATION
Bottom View

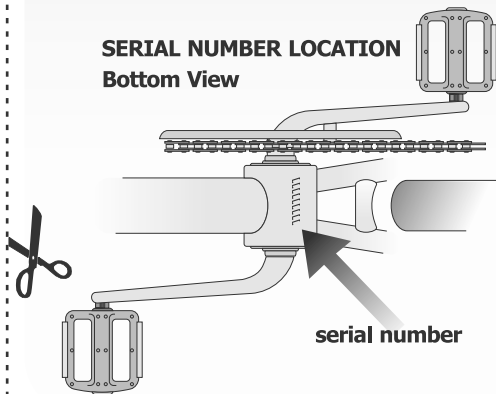

177 Malaga Park Dr.
Malaga, NJ 08328

Call Toll Free:
1-866-204-9737
Monday-Friday 8:00AM to 5:00PM (CST)

For product related questions email us at:
info@hyperbicycles.com
For customer service questions email us at:
service@hyperbicycles.com

VISIT US ONLINE@
www.hyperbicycles.com

TOLL FREE SERVICE HOTLINE

1-866-204-9737



177 Malaga Park Dr.
Malaga, NJ 08328

Toll Free: 1-866-204-9737

Monday-Friday 8:00AM to 5:00PM (CST)

For product related questions email us at: info@hyperbicycles.com

For customer service questions email us at: service@hyperbicycles.com

