



# COOLBOOK3.0

100% Made in Italy

*Your guide to innovative  
professional refrigeration products*

CATALOGO GENERALE  
GENERAL CATALOG  
CATALOGUE GÉNÉRAL  
GESAMTKATALOG  
CATÁLOGO GENERAL  
GENEL KATALOG  
ОБЩИЙ КАТАЛОГ

### The Real Made in Italy

Desmon S.p.A was founded in 1994 by the family De Santis as a food equipment trading company.

In 1998 the company has taken over a local manufacturing company and started production of refrigeration equipment. After a few successful years the company became one of the leaders in the European market of professional refrigeration.

100% of the production of professional refrigeration equipment is concentrated in the main factories in Italy.

### Who prefers Desmon...

... is conscious to do the best choice in the professional refrigeration field. Desmon's primary objective is to maintain high quality standards and to achieve full customer satisfaction.

Those who choose Desmon know that they obtain a huge selection of products produced by the superior ability of Desmon workers, from the body to the smallest detail.

Those who choose Desmon know that they have a product built to last, and day after day will appreciate the material quality, the reliability in technology and its enhanced design.



### Il Vero Made in Italy

Desmon S.p.A è stata fondata dalla famiglia De Santis nel 1994, come azienda per la commercializzazione di attrezzature per il catering.

Nel 1998, Desmon rileva un marchio storico della refrigerazione professionale avviando la produzione di frigoriferi professionali a marchio proprio. In pochi anni Desmon diventa un punto di riferimento europeo nella produzione di attrezzature refrigerate per il catering.

**Il 100%** delle attrezzature refrigerate prodotte da Desmon vengono realizzate nei due opifici di circa 25.000mq interamente coperti siti in Nusco (AV).

### Chi sceglie Desmon...

... è consapevole di fare la scelta migliore nel campo della refrigerazione professionale.

Obiettivo primario della Desmon è quello di mantenere alti gli standard qualitativi e raggiungere la piena soddisfazione dei propri clienti.

Chi sceglie Desmon sa di poter attingere ad una vastissima gamma di prodotti realizzati interamente dalla sapiente mano degli uomini Desmon, dalla scocca al più piccolo particolare..

Chi ha scelto Desmon sa di avere un prodotto creato per durare nel tempo, apprezzandone giorno dopo giorno la qualità dei materiali, l'affidabilissima tecnologia ed il Design sobrio e sempre attuale.



## Superior Materials

Every product is produced with the greatest care for the details. Desmon's primary objective is to produce the highest quality products, for this reason it chooses only high quality materials, to ensure that the Desmon products last a long time regardless of the application.

It's for this reason that Desmon uses only stainless steel of superior quality. All internal and external structures are stainless steel, such as the doors, the adjustable pedestals and the table and cabinet handles.

All Desmon models present tropicalized refrigerating units. Other characteristics of our products are the strength and the high reliability that can guarantee the right functionality even if exposed to excessive usage in an "unfriendly environment".

## Materiali Superiori

Ogni prodotto è realizzato con la massima cura per i particolari; Desmon ha come obiettivo primario la qualità dei propri prodotti, per questo sceglie unicamente materiali di standard elevatissimo, in modo da far durare e mantenere inalterati nel tempo i propri prodotti.

È per questo che Desmon usa solo acciai di qualità superiore. Le strutture interne ed esterne sono in acciaio inox, come le porte, i regolabili e le impugnature sia dei tavoli che degli armadi.

Tutti i modelli Desmon sono dotati di serie di unità refrigeranti tropicalizzate. Ulteriori caratteristiche dei nostri prodotti sono la robustezza e l'alta affidabilità capaci di garantire la buona funzionalità dei prodotti anche se sottoposti ad un uso esasperato.

## Certified Quality

We believe that every process designed to control production and make information objective and available improves the relationship with our customers, both the internal and external ones. It's this transparency that controls our job.

## Qualità Certificata

Crediamo che ogni processo tendente ad rendere controllata, oggettiva e fruibile l'informazione, migliori la relationship con i nostri clienti, interni ed esterni; è la trasparenza a governare il nostro lavoro.



ISO 9002 - 9001:2000 VISION 2000 - ISO 14001  
CE - ETL - GOST (PCT) - UkrSEPRO - EAC



**- 41% di consumo**

## Energy Saving & Low Emission



Respect for the environment is in DNA of Desmon and confirmed by decades of continuous improvement and implementation of environmentally efficient production processes. Desmon is always careful on every single step of a product life cycle, from design to disposal, having in mind an intention to reduce an impact on environment and create benefits for customers from decreasing energy costs. Desmon has obtained ISO-14001 certificate for a commitment to respect an environment on every stage of business activity.

*Il rispetto per l'ambiente è da sempre nel DNA del Gruppo Desmon. Questa vocazione trova conferma in decenni di continuo impegno nella ricerca di processi produttivi efficienti nel rispetto dell'ambiente. La Desmon è da sempre attenta a ciascuna fase del ciclo di vita dei propri prodotti, dalla progettazione allo smaltimento, con l'obiettivo di ridurre al minimo l'impatto ambientale e di incrementare i benefici per il Cliente (minori costi energetici). A prova dell'impegno costante, Desmon ha ottenuto la certificazione ISO 14001. La salvaguardia dell'ambiente è talmente sentita in Desmon che coinvolge ogni singola attività aziendale e tutte le varie fasi del ciclo vitale del prodotto.*

Desmon is one of manufacturer of commercial refrigeration in the world using cyclopentane. Desmon products have a Cyclopentane thermoinsulation which does not damage an ozone layer and does not make a greenhouse effect. Cyclopentane replaces polyurethane foams based on HCFCs and CFCs which destroy an ozone layer and generate the greenhouse effect.

*Desmon è stata tra le prime aziende al mondo ad utilizzare la schiuma al ciclopentano per l'isolamento termico dei propri prodotti, un gas che non danneggia l'ozono e non produce effetto serra. Il ciclopentano sostituisce le schiume poliuretaniche basate su HCFC e CFC, estremamente nocive per l'ambiente.*

Desmon is constantly searching for new solutions to create products with a minimum negative impact on environment. Among those solutions Desmon develops a refrigeration units which use a natural gas R290 (propane) see IRIDIUM Line.

*Desmon è costantemente alla ricerca di nuove soluzioni per creare prodotti che abbiano il minimo impatto ambientale. Tra queste soluzioni Desmon ha sviluppato unità di refrigerazione che utilizzano un gas naturale R290 vedi Linea IRIDIUM.*

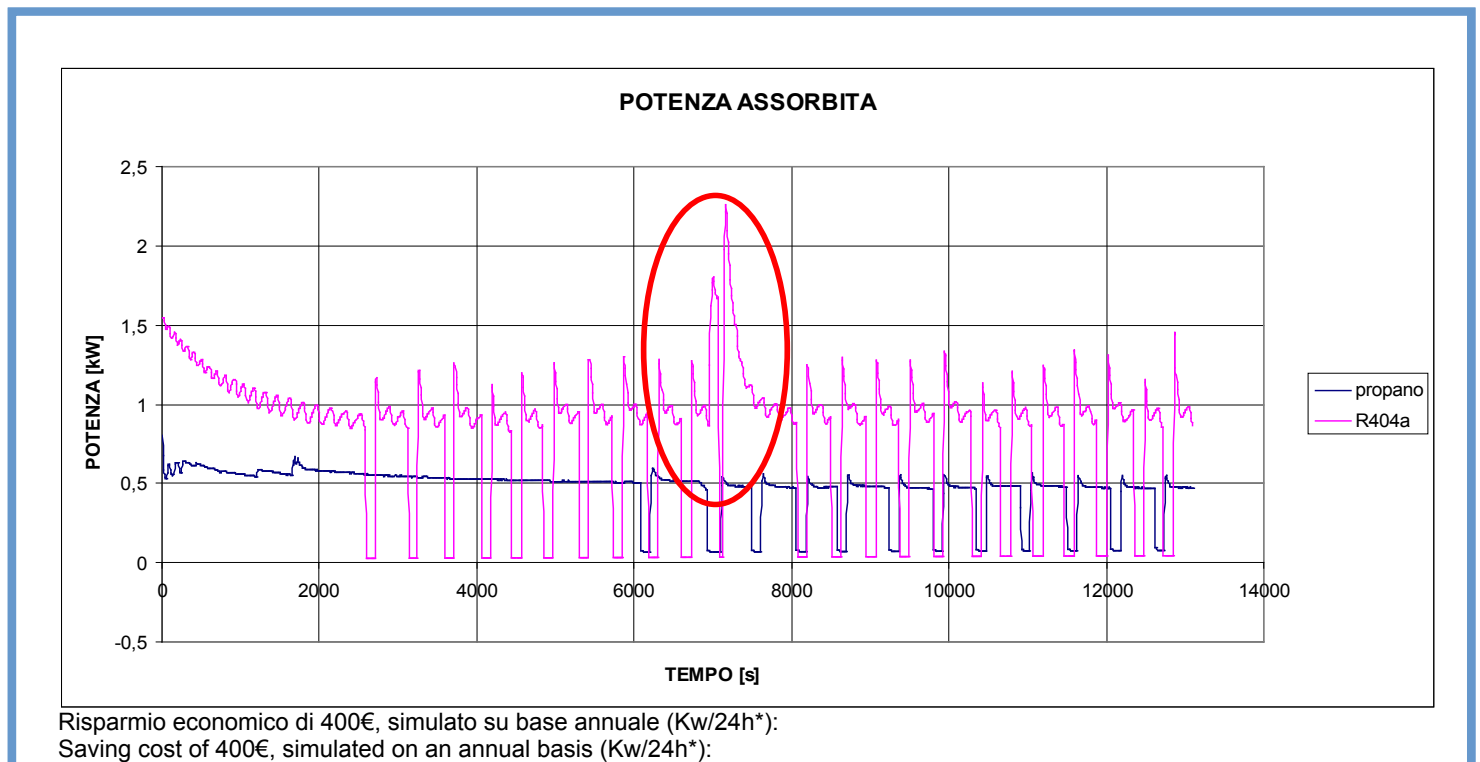

\*costo Kw di 15 cent - price of Kw 15 cent



### Energy Saving 41%

Energy consumption absorbed on R404A cooling system: 18,4kWh/24h;

Energy consumption absorbed on R290 cooling system: 10,80kWh/24h.

### Risparmio energetico del 41%

Energia elettrica assorbita dall'impianto tradizionale: 18,4kWh/24h;

Energia elettrica assorbita dall'impianto a propano: 10,80kWh/24h.

# Desmon

## CypenVac Technology

Revolutionary technology for thermal insulation, which allows an energy saving of

**-38% in storage**

**-43% in Freezing**

Increases the effectiveness of the thermal insulation of 100%.

Aumenta notevolmente l'efficacia dell'isolamento termico, portando un risparmio energetico del 38% in conservazione e del 43% in congelamento.

**Increase price list of 25%**  
**Incrementare il prezzo di listino del 25%**

CypenVac is an innovative insulation system alternative to polyurethane foam, consisting of panels containing insulating material in powder under vacuum. In this way you get a 'thermal insulation of refrigerators, freezers and blast chillers. Advantages: The insulation system is obtained by Cypenvac allows to obtain reductions in energy consumption in the order of 40% compared to traditional polyurethane insulation system under equal conditions of isolation. Besides the significant energy saving technology Cypenvac allows to reduce the use of polyurethane for thermal insulation, and this positively affects reducing emissions of cyclopentane in the atmosphere during the foaming. In conclusion Cypenvac technology allows to safeguard the environment both by reducing CO2 emissions during operation of the final product, both HCFC emissions during production of the same, and at the same time allows the product to have an energy efficiency greater.

## Thermal Insulation

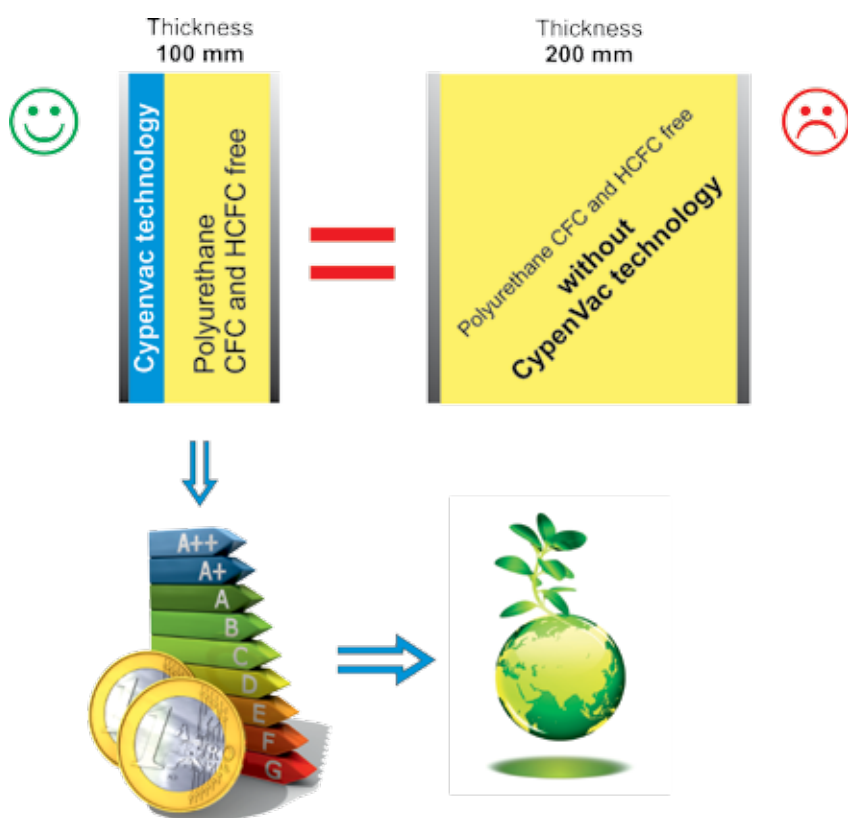

### Innovativo sistema di isolamento termico che assicura un risparmio energetico fino al 43%

CypenVac è un innovativo sistema di isolamento alternativo alla schiuma poliuretanic, costituito da pannelli contenenti materiale isolante in polvere sotto vuoto. In questo modo si ottiene un'isolamento termico ad alto rendimento per Frigoriferi, congelatori ed abbattitori rapidi di temperatura. Vantaggi: Il sistema di isolamento ottenuto mediante Cypenvac permette di ottenere riduzioni dei consumi energetici nell'ordine del 40% rispetto al sistema di isolamento tradizionale a poliuretano a parità di condizioni di isolamento. Oltre al notevole risparmio energetico la tecnologia Cypenvac consente di ridurre l'utilizzo di poliuretano per l'isolamento termico e ciò incide positivamente riducendo le emissioni di ciclopentano in atmosfera in fase di schiumatura. In conclusione la tecnologia Cypenvac permette di salvaguardare l'ambiente sia riducendo le emissioni di CO2 in fase di funzionamento del prodotto finale, sia le emissioni di HCFC in fase di produzione dello stesso, ed allo stesso tempo consente al prodotto di avere un'efficienza energetica maggiore.

<b>GASTRONOMY</b>	
<b>RISTORAZIONE</b>	<b>7</b>
<b>SILVER LINE</b>	
REACH-IN	
ARMADI REFRIGERATI	7
ACCESSORIES	
ACCESSORI	11
INOX SHOW CASE	
ESPOSITORE REFRIGERATO	12
<b>GOLD LINE</b>	
REACH-IN	
ARMADI REFRIGERATI	13
KNOCKING DOWN CABINETS	
ARMADI REFRIGERATI SMONTABILI	22
<b>REMOTE COOLING UNITS</b>	
UNITÀ REFRIGERANTE REMOTA	23
ACCESSORIES	
ACCESSORI	23
<b>UNITED COLOR OF DESMON (COLOURED CABINETS)</b>	24
<b>PLATINUM LINE</b>	25
ROLL-IN / ROLL TRHU	26
<b>IRIDIUM LINE - R290</b>	29
REACH-IN & REFRIGERATED WORK TABLES	
ARMADI E TAVOLI REFRIGERATI	31
REFRIGERATED TABLES	
TAVOLI REFRIGERATI	33
ACCESSORIES	
ACCESSORI	34
<b>SILVER LINE</b>	
REFRIGERATED WORK TABLES	
TAVOLI REFRIGERATI	35
REMOTE COOLING UNITS	
UNITÀ REFRIGERANTE REMOTA	38
ACCESSORIES	
ACCESSORI	40
<b>DRAWER SET</b>	
CASSETTIERE	41
<b>GOLD LINE</b>	
REFRIGERATED WORK TABLES	
TAVOLI REFRIGERATI	43
REMOTE COOLING UNITS	
UNITÀ REFRIGERANTE REMOTA	46
KNOCKING DOWN WORK TABLES	
TAVOLI REFRIGERATI SMONTABILI	47
ACCESSORIES	
ACCESSORI	48
<b>PASTRY LINE</b>	
<b>PASTICCERIA</b>	49
<b>GOLD LINE</b>	
REACH-IN	
ARMADI REFRIGERATI	50
REFRIGERATED WORK TABLES	
TAVOLI REFRIGERATI	52
ACCESSORIES	
ACCESSORI	54
<b>ICE CREAM</b>	
<b>GELATERIA</b>	55
<b>BLAST &amp; SHOCK FREEZERS</b>	
<b>ABBATTITORI RAPIDI DI TEMPERATURA</b>	59
ACCESSORIES	
ACCESSORI	64
<b>FOOD &amp; PIZZA PREP TABLES</b>	
<b>TAVOLI PREPARAZIONE - SALDETTES - PIZZA</b>	65
<b>BAR SYSTEM</b>	80
<b>BEER BOX</b>	82
<b>UNDERCOUNTER</b>	84
<b>GENERAL CONDITIONS - CONDIZIONI GENERALI DI VENDITA</b>	85

# Silver line

## Qualità & Affidabilità

Spessore isolamento fino a 75mm senza CFC E HCFC;  
Da 50 mm su SlimLine

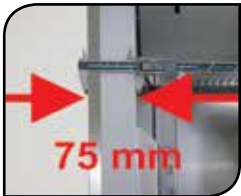

Insulation thickness until to 75 mm CFC & HCFC free. 50 mm of thickness for SlimLine

Cremagliere amovibili senza l'uso di utensili



Completely removable racking for easy cleaning

Griglie Plastificate posizionabili ogni 60mm



Trayslide adjustable at 60mm intervals

Esterno in acciaio inox AISI 304/441



Exterior in Stainless steel AISI 304/441



Unità refrigerante a Monoblocco per sfruttare tutta la capacità di stoccaggio. (escluso SlimLine)



Compact Refrigeration System featuring designed to maximise available capacity. (not available on SlimLine)

Guarnizione amovibili per una facile pulizia



Wide magnetic gasket gives effective seal and is removable for easy cleaning

Cruscotto incernierato per consentire facile accesso alle parti elettriche ed all'unità motocondensante.



Hinged control panel for service access

Interno in acciaio Inox AISI 304/441 Angoli interni arrotondati



Interior Stainless Steel AISI 304/441. Rounded corner internal for easy cleaning

## Quality & Reliability

## Armadi - Reach-ins - Armoires - Kühlschränke - Armarios - Dik Buzdolaplari - Холодильные шкафы

 <p>Controllo Elettronico Ventilato - H.A.C.C.P su richiesta Unità refrigerante a monoblocco (escluso SlimLine) Sbrinamento automatico Evaporazione automatica (escluso SlimLine)</p>	<p>Gas : R404a Isolamento da 60 e 75 mm senza CFC / HCFC Isolam. da 50 mm senza CFC/HCFC (SlimLine) Esterno/Interno in acciaio inox AISI 441 Angoli interni arrotondati Serratura con chiavi (Optional) Piedini regolabili in ABS</p>	<p>Piedini regolabili in Inox (Optional) Porte reversibili e autochiudenti Griglie plastificate dim. 530x650mm Griglie inox dim. 530x650mm (Optional)</p>
 <p>Electronic control Ventilated H.A.C.C.P. function available Compact refrigeration System (not available on the SlimLine) Auto defrost Auto evaporation (not available on the SlimLine)</p>	<p>Gas: R404a Polyurethane insulation 60 and 75mm CFC/HCFC free insulation 50mm CFC &amp; HCFC free (Slim Line) 441 Grade Stainless Steel Interior/Exterior Interior rounded corner Lockable Doors (Accessory on request) Adjustable plastic feet</p>	<p>Adjustable Inox feet on request Reversible &amp; Self closing doors Plastic-coated shelves dim. 530x650 mm Stainless Steel shelves dim. 530x650 mm on request</p>
 <p>Contrôle électronique Froid ventilé Options dispositif H.A.C.C.P Unité Réfrigérante compacte (non prévu pour la gamme SlimLine) Dégivrage automatique avec réévaporation des eaux (non prévu)</p>	<p>pour la gamme SlimLine) Gaz: R404a Isolation épaisseur 60 et 75 mm sans CFC/HCFC Isolation ép. 50 mm sans CFC/HCFC (SlimLine) Revêtement Intérieur/extérieur en Acier Inox AISI 441</p>	<p>Angles arrondis intérieur Option serrures à clé sur chaque porte Pieds réglables en ABS options en Acier Inox 304 Portes réversibles et Fermeture automatique Grille Plastifiée dim. 530x650 mm Option Grille Inox dim. 530x650 mm</p>
 <p>Elektronische steuerung H.A.C.C.P Optional - Umluft Automatische Abtaung Automatische Abtauwasserverdunstung (SLIM LINE) bei Version SM6-SB6 / SM7-SB7 Kühlmittel R404a Kühlaggregat Monoblockbauweise nur bei Version SM6-SB6 / SM7-SB7</p>	<p>Isolationsstärke 60 und 75 mm ohne CFC und HCFC Isolationsstärke 50mm ohne CFC und HCFC (SLIM LINE) Energieeinsparung Aussen / Innen Inox (Edelstahl) AISI 441 Intern abgerundete Ecken Türschloss (Optional)</p>	<p>Höhenverstellbare Plastikfüsse Höhenverstellbare Inoxfüsse (Optional) Türanschlag wechselbar Plastikbeschichtete Roste ABMeßungen 530x650mm Inox (Edelstahl) Roste ABMeßungen 530x650mm (Optional)</p>
 <p>Control electrónico Ventilado H.A.C.C.P. si requerido Descongelación automática Evaporación automática Gas:R404a Aislamiento desde 60 y 75 mm y sin</p>	<p>CFC /HCFC Aislamiento desde 50 mm sin CFC/HCFC (SlimLine) Externo/Interno en acero inox AISI 441 Esquinas internas redondeadas Cerradura con llave(optional) Soportes ajustables en ABS</p>	<p>Soportes ajustables en Inox (optional) Puertas reversibles y autocerrantes Parillas plastificadas dim. 530x650 mm Parillas inox dim. 530x650 mm (optional)</p>
 <p>Elektronik Kontrol Fanlı Soğutma H.A.C.C.P Fonksiyonu Opsiyonel Otomatik Defrost Otomatik Evaporasyon Gaz: R 404 A Poliüretan İzolasyon 60 (75) mm</p>	<p>CFC/HCFC Free İzolasyon 50 mm CFC &amp; HCFC Free (Slim Line'da) Enerji Tüketiminde % 20 Tasarruf 441 Kalite Paslanmaz Çelik İç ve Dış Gövde Yuvarlatılmış İç Köşeler Kilitlenebilir Kapılar (İstek Üzerine)</p>	<p>Ayarlanabilir Plastik Ayaklar Ayarlanabilir Paslanmaz Ayaklar Opsiyonel Yön Değiştirilebilir &amp; Kendinden Kapanan Kapılar Plastik Kaplı Raflar Ölçüsü: 530x650 mm İstek Üzerine Paslanmaz Raflar Ölçüsü: 530x650 mm</p>
 <p>Электронное управление Вентилируемый функция H.A.C.C.P. под заказ Компактная система охлаждения (не для моделей Slim line) Автоматическое размораживание Автоматическое испарение (не для моделей Slim line)</p>	<p>Фреон R404a Полиуретановый изолирующий слой 60 (75) мм, без CFC/HCFC Изолирующий слой 50мм без CFC &amp; HCFC (Slim Line) Внутренняя и внешняя отделка из нержавеющей стали AISI 441 Внутренние закругленные углы</p>	<p>Замок на двери с ключами (под заказ) Регулируемые пластиковые ножки Регулируемые ножки из нержавеющей стали (под заказ) Перевешиваемые и самозакрывающиеся двери Покрытые пластиком решетки с размерами 530x650 мм Решетки из нержавеющей стали с размерами 530x650 мм (под заказ)</p>



## PROF. 60 CM



SM40X  
SB40X



SM40X-G  
SB40X-G



SF40X

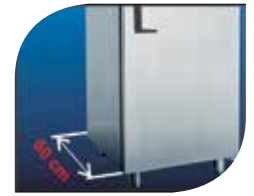

Modello Model Modell Modelo Model Модель	Price	Temperature	Capacity	Refrig. Power	Voltage	Abs. Power	Dimensions	Packing Dim.	Shelves	Ambient Temp.	Weight
	€	°C	Lt	Watt	Volt/Hz	Watt	WxDxH cm	WxDxH cm	N°	°C	kg
SM40X		-2° +8°	400	308	220-240/50	270	60x60x190	64x64x205	3	43	75
SB40X		-10° -25°	400	338	220-240/50	363	60x60x190	64x64x205	3	43	80
SM40X-G		-2° +8°	400	407	220-240/50	330	60x60x190	64x70x205	3	43	85
SB40X-G		-10° -25°	400		220-240/50		60x60x190	64x70x205	3	43	87
SF40X		0° -5°	400	387	220-240/50	325	60x60x190	64x64x205	5 Bac/Trays	43	80



SM80X  
SB80X



SM80XG



SF80X



Modello Model Modell Modelo Model Модель	Price	Temperature	Capacity	Refrig. Power	Voltage	Abs. Power	Dimensions	Packing Dim.	Shelves	Ambient Temp.	Weight
	€	°C	Lt	Watt	Volt/Hz	Watt	WxDxH cm	WxDxH cm	N°	°C	kg
SM80X		-2° +8°	800	407	220-240/50	330	120x60x190	124x64x205	6	+43	130
SB80X		-10° -25°	800	465	220-240/50	477	120x60x190	124x64x205	6	+43	140
SM80XG		-2° +8°	800	407	220-240/50	330	120x60x190	124x70x205	6	+43	150
SB80XG		-10° -25°	800		220-240/50		120x60x190	124x70x205	6	+43	140
SF80X		0° -5°	800	555	220-240/50	443	120x60x190	124x64x205	10 Bac/Trays	+43	140

### Accessori - Accessories - Accessoires - Zubehör - Accesorios - Seçenekleri - Доп. опция

H.A.C.C.P.				
<p>Controllo H.A.C.C.P. H.A.C.C.P. control Contrôle avec dispositif HACCP Steuerung mit H.A.C.C.P. Control electrónico H.A.C.C.P. Kontrol H.A.C.C.P. Электронное управление HACCP</p>	<p>Ruote piroettanti, 2 con freno Lockable castors, 2 with brakes Roulettes pivotantes, 2 avec freins Fussrollen, zwei mit Bremsen Ruedas giratorias, dos con freno Kilitli Tekerlekler, iki Frenli Ножки с колесиками, две – с тормозами</p>	<p>Serratura per ogni porta Door lock for each door Serrure à clé Türschloss Cerradura con llave Kilitlenebilir Kapılar Замок на двери с ключами</p>	<p>Kit Griglia plastificata con guide Plastic-coated shelf with guides Grille plastifiée avec glissières Plastifizierter Rost mit Schienen Parrilla Plástica con guías Plastik kapli çelik raf raylarla beraber Пластифицированные решетки с направляющими</p> <p><b>460x485</b></p>	<p>Falso fondo inox Stainless Steel holed plate Double fond en inox perforé Inox-SieBBoden Plancha de acero pinchada Paslanmaz çelik delikli sac Лже-дно из нержавеющей стали с отверстиями</p>

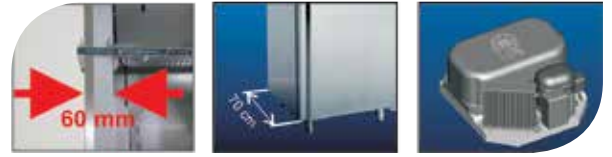

SM6 - SB6

SM12 - SB12

Modello Model Modell Modelo Model Модель	Price	Temperature	Capacity	Refrig. Power	Voltage	Abs. Power	Dimensions	Packing Dim.	Shelves	Ambient Temp.	Weight
	€	°C	Lt	Watt	Volt/Hz	Watt	WxDxH cm	WxDxH cm	N°	°C	kg
SM6		-2° +8°	600	375	220-240/50	335	72x70x212	78x85x228	3	+43	105
SB6		-10° -25°	600	474	220-240/50	510	72x70x212	78x85x228	3	+43	115
SM12		-2° +8°	1200	415	220-240/50	440	144x70x212	148x74x228	6	+43	165
SB12		-10° -25°	1200	780	220-240/50	755	144x70x212	148x74x228	6	+43	180

### Guide stampate

### GASTRONORMGN2/1

### Embossed guides



SM7 - SB7

SM14 - SB14

SM7G - SB7G

SM14G - SB14G

Modello Model Modell Modelo Model Модель	Price	Temperature	Capacity	Refrig. Power	Voltage	Abs. Power	Dimensions	Packing Dim.	Shelves	Ambient Temp.	Weight
	€	°C	Lt	Watt	Volt/Hz	Watt	WxDxH cm	WxDxH cm	N°	°C	kg
SM7		-2° +8°	700	375	220-240/50	335	68,5x80x212	74x84x228	3	+43	120
SM7G		-2° +8°	700	415	220-240/50	440	68,5x80x212	74x90x228	3	+43	120
SB7		-10° -25°	700	474	220-240/50	510	68,5x80x212	74x84x228	3	+43	130
SB7G		-10° -25°	700	803	220-240/50	738	68,5x80x212	74x90x228	3	+43	160
SM14		-2° +8°	1400	415	220-240/50	440	134x80x212	138x84x228	6	+43	190
SM14G		-2° +8°	1400	929	220-240/50	600	134x80x212	138x90x228	6	+43	190
SB14		-10° -25°	1400	780	220-240/50	755	134x80x212	138x84x228	6	+43	200
SB14G		-10° -25°	1400	1063	220-240/50	1000	134x80x212	138x90x228	6	+43	270



**Max 24 ripiani per porta**

**Max 24 racks for each door**

- Questi accessori possono essere ordinati esclusivamente insieme al prodotto a cui si riferiscono, e non possono essere ordinati separatamente. I prezzi degli accessori, indicati in questo listino, sono solo incrementi e non normali prezzi di vendita. Per ordini separati è necessario consultare il listino ricambi non incluso in questo catalogo.
- Those options are to be ordered only at the moment of ordering a corresponding model and it is impossible to order them separately. The price of the accessories represents only the price increasing and it isn't the accessories price list. To order other accessories, please, check a separate "Spare parts list price".
- Ces accessoires ne peuvent être commandés à ce prix qu'avec le meuble, et ne peuvent pas l'être séparément. Pour commande séparée uniquement d'accessoires, il est nécessaire de consulter le tarif pièces détachées non inclu dans ce catalogue.
- Dieses Zubehör kann nur ausschließlich in Phase der Bestellung des Produktes bestellt werden, auf die sie sich beziehen, und können nicht separat bestellt werden. Für die Bestellung von Ersatzteilen ist der Ersatzteilkatalog zu konsultieren der nicht in diesem Listenpreis beigefügt ist.
- Estos accesorios se pueden ordenar exclusivamente en fase de pedido del producto al que se refieren, y no se pueden pedir separadamente. Los precios de los accesorios, indicados en este listín, son sólo incrementos y no normales precios de venta. Por pedidos separados es necesario consultar el listín accesorios no incluido en este listín.
- Buu katalogda gösterilen aksesuar fiyatları sadece katalog fiyatlarıdır, normal satış fiyatları değildir. Ayrı siparişler için, bu kataloga dahil olmayan Yedek Parça Fiyat Listesi kullanılmalıdır.
- Эти аксессуары должны быть заказаны вместе с основными моделями и не могут поставляться отдельно. В случае заказа этих опций к цене основной модели надо будет добавить цену опции. Для заказа остальных аксессуаров и запасных частей, пожалуйста, смотрите отдельный прайс-лист «аксессуары».

<p><b>H.A.C.C.P.</b></p>			<p><b>530x550</b></p>	
<p>Controllo H.A.C.C.P. H.A.C.C.P. control Contrôle avec dispositif HACCP Steuerung mit H.A.C.C.P. Control electrónico H.A.C.C.P. Kontrol H.A.C.C.P. Электронное управление HACCP</p>	<p>Ruote piroettanti, 2 con freno Lockable castors, 2 with brakes Roulettes pivotantes, 2 avec freins Fussrollen, zwei mit Bremsen Ruedas giratorias, dos con freno Kilitli Tekerlekler, iki Frenli Ножки с колесиками, две – с тормозами</p>	<p>Serratura Door lock Serrure à clé Türschloss Cerradura con llave Kilitlenebilir Kapılar Замок на двери с ключами</p>	<p>Kit Griglia plastificata con guide Plastic-coated shelf with guides Grille plastifiée avec glissières Plastifizierter Rost mit Schienen Parilla Plastificada con guías Plastik kapli çelik raf raylarla beraber Пластифицированные решетки с направляющими</p>	<p>Kit piedini inox Adjustable stainless steel feet Pieds réglables en acier inox Höhenverstellbare Inoxfüsse Soportes ajustables en Inox Ayarlanabilir Paslanmaz Ayaklar Регулируемые ножки из нержавеющей стали</p>
			<p><b>530x650</b></p>	
<p>Piede inox flangiato S/S flanged foot Pied butée Edelstahl Fuss mit Flansch</p>	<p>Ruote piroettanti, 2 con freno Lockable castors, 2 with brakes Roulettes pivotantes, 2 avec freins Fussrollen, zwei mit Bremsen Ruedas giratorias, dos con freno Kilitli Tekerlekler, iki Frenli Ножки с колесиками, две – с тормозами</p>	<p>Serratura Door lock Serrure à clé Türschloss Cerradura con llave Kilitlenebilir Kapılar Замок на двери с ключами</p>	<p>Griglia plastificata Plastic-coated shelf Grille plastifiée Plastifizierter Rost Parilla Plastificada Plastik kapli çelik Пластифицированные решетки</p>	<p>Kit piedini inox Adjustable stainless steel feet Pieds réglables en acier inox Höhenverstellbare Inoxfüsse Soportes ajustables en Inox Ayarlanabilir Paslanmaz Ayaklar Регулируемые ножки из нержавеющей стали</p>
<p><b>220V-60Hz</b></p>	<p><b>115V-60Hz (NO ETL-UL)</b></p>			
<p>Alimentazione Voltage</p>	<p>Alimentazione Voltage</p>	<p>Armadio predisposto per unità refrigerante remota Cabinet designed for remote cooling unit Armoires conçu pour unité ermetique à distance Für fern Kühlaggregat vorgesehen</p>		<p>Unità refrigerante remota Remote Cooling Unit Unité réfrigérante à distance Kühlaggregat nicht inbegriffen</p>



### ESPOSITORE MURALE INOX

### INOX SHOW CASE

Modello Model Modell Modelo Model Модель	Price	Temperature	Capacity	Refrig. Power	Voltage	Abs. Power	Dimensions	Packing Dim.	Shelves	Ambient Temp.	Weight
	€	°C	Lt	Watt	Volt/Hz	Watt	WxDxH cm	WxDxH cm	N°	°C	kg
ES70X		-3° +6°	500	1105	220-240/50	860	70x80x191	74x84x210	4	+32	100

Accessori - Accessories - Accessoires - Zubehör - Accesorios - Seçenekleri - Доп. опция

Tendina notte  
Nigh Curtain



Serratura di serie  
Door lock as standard  
Serrure à clé de série  
Cerradura en serie

Modello Model Modell Modelo Model Модель	Price	Temperature	Capacity	Refrig. Power	Voltage	Abs. Power	Dimensions	Packing Dim.	Shelves	Ambient Temp.	Weight
	€	°C	Lt	Watt	Volt/Hz	Watt	WxDxH cm	WxDxH cm	N°	°C	kg
SM550		-2° +8°	550	459	220-240/50	309	70X80X199	74X84X215	3	+43	110
SB550		-10° -25°	550	531	220-240/50	458	70X80X199	74X84X215	3	+43	120

## PROF. 86 CM



Serratura di serie  
Door lock as standard  
Serrure à clé de série  
Cerradura en serie

Modello Model Modell Modelo Model Модель	Price	Temperature	Capacity	Refrig. Power	Voltage	Abs. Power	Dimensions	Packing Dim.	Shelves	Ambient Temp.	Weight
	€	°C	Lt	Watt	Volt/Hz	Watt	WxDxH cm	WxDxH cm	N°	°C	kg
SCM6		-2° +8°	600	563	220-240/50	419	70x86x199	72x90x215	5	+43	110

H.A.C.C.P. di serie



H.A.C.C.P. as standard

Spessore isolamento da 75mm su modelli IG. 60 mm sul resto della gamma.

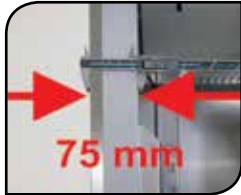

Insulation thickness to 75 mm on IG model. 60 mm of thickness for the rest of the range.

Cremaie amovibili senza l'uso di utensili



Completely removable racking for easy cleaning

Cruscotto incernierato per consentire facile accesso alle parti elettriche ed all'unità motocondensante.



Hinged control panel for service access

Esterno in acciaio inox Aisi 304. A richiesta schienale in acciaio per installazione ad isola.



304 Grade in Stainless steel exterior. Complete stainless steel back option for island siting.

Serratura di serie



Door lock as standard

Luce interna di serie



Interior light as standard

Unità refrigerante a mono-blocco per sfruttare tutta la capacità di stoccaggio.



Compact Refrigeration System featuring designed to maximise available capacity.

Griglie plastificate posizionabili ogni 60 mm



Trayside adjustable at 60mm intervals

Gurnizioni removibili per una facile pulizia



Wide magnetic gasket gives effective seal and is removable for easy cleaning

Interno in acciaio Aisi 304. Angoli interni arrotondati.



Interior Stainless Steel AISI 304. Rounded corner internal for easy cleaning



## Armadi - Reach-ins - Armoires - Kühlschränke - Armarios - Dik Buzdolapları - Холодильные шкафы



Controllo Elettronico  
 H.A.C.C.P di serie  
 Unità refrigerante a monoblocco  
 Sbrinatorio automatico  
 Evaporazione automatica  
 Gas : R404a

Luce interna di serie  
 Isolamento 60 mm privo di CFC/HCFC  
 Risparmio Energetico del 20%  
 Esterno/Interno in acciaio inox AISI 304  
 Angoli interni arrotondati  
 Serratura con chiavi di serie

Piedini regolabili in Inox  
 Porte reversibili e autochiudenti  
 Griglie plastificate dim. 530x650mm  
 Griglie inox dim. 530x650mm (Optional)



Electronic control  
 H.A.C.C.P. as standard  
 Compact refrigeration system  
 Auto defrost  
 Auto evaporation  
 Gas: R404a

Polyurethane insulation 60 mm  
 CFC/HCFC free  
 20% saving on energy consumption  
 304 Grade Stainless Steel Interior/Exterior  
 Interior rounded corner  
 Door lock as standard  
 Interior Light as standard

Adjustable Inox feet  
 Reversible & Self closing doors  
 Plastic-coated shelves  
 dim. 530x650 mm  
 Stainless Steel shelves  
 dim. 530x650 mm available on request



Contrôle électronique  
 Contrôle électronique H.A.C.C.P  
 Unité réfrigérante compacte  
 Dégivrage automatique avec  
 réévaporation des eaux  
 Gaz: R404a

Isolation épaisseur 60 mm sans CFC/HCFC  
 Revêtement Intérieur/extérieur  
 en Acier Inox AISI 304  
 Angles arrondis intérieur  
 Lumière Intérieure  
 Serrure à clé sur chaque porte

Pieds réglables en Acier Inox 304  
 Portes réversibles et  
 Fermeture automatique  
 Grille Plastifiée dim. 530x650 mm  
 Options Grille Inox dim. 530x650 mm



Elektronische steuerung  
 H.A.C.C.P Serienmässig  
 Kühlaggregat Monoblockbauweise  
 Automatische Abtaug  
 Automatische Abtauwasserverdunstung  
 Kühlmittel R404a  
 Licht Serienmässig

Isolationsstärke 60mm ohne CFC und HCFC  
 Energieeinsparung bis zu 20%  
 Aussen / Innen Inox (Edelstahl) AISI 304  
 Intern abgerundete Ecken  
 Türschloss Serienmässig  
 Höhenverstellbare Inoxfüsse  
 Türanschlag wechselbar - Selbstschliessend

Plastikbeschichtete Roste ABmessungen  
 530x650mm  
 Inox (Edelstahl) Roste ABmessungen  
 530x650mm (Optional)



Control electrónico  
 H.A.C.C.P. de serie  
 Unidad refrigerante monobloque  
 Descongelación automática  
 Evaporación automática  
 Gas: R404a

Luz interna de serie  
 Aislamiento 60mm sin empleo de CFC/HCFC  
 Ahorro energético del 20%  
 Externo/Interno en acero inox AISI 304  
 Esquinas internas redondeadas  
 Cerradura con llaves de serie  
 Soportes ajustables en Inox

Puertas reversibles y autocerrantes  
 Parrillas plastificadas dim.530 por 650mm  
 Parrillas inox dim.530 por 650 mm (optional)



H.A.C.C.P Fonksiyon Standart  
 Kompak Soğutma Sistemi  
 Otomatik Defrost  
 Otomatik Evaporasyon  
 Gaz: R 404 A  
 Poliüretan İzolasyon 60 mm  
 CFC/HCFC Free

Enerji Tüketiminde % 20 Tasarruf  
 304 Kalite Paslanmaz Çelik Dış ve İç Gövde  
 Yuvarlatılmış İç Köşeler  
 Kapıda Kilit Standarttır  
 İç Işıklandırma Standarttır  
 Ayarlanabilir Paslanmaz Ayaklar  
 Yön Değiştirilebilir & Kendinden Kapanan Kapılar

Plastik Kaplı Raflar Ölçüsü: 530x560 mm  
 İstek Üzerine Paslanmaz Çelik Raflar Ölçüsü:  
 530x560 mm



Электронное управление  
 Функция H.A.C.C.P. в комплекте  
 Компактная система охлаждения  
 Автоматическое размораживание  
 Автоматическое испарение  
 Фреон R404a  
 Полиуретановый изолирующий слой

60мм без CFC/HCFC  
 20%- ая экономия электроэнергии  
 внешняя и внутренняя отделка из  
 нержавеющей стали AISI 304  
 Внутренние закругленные углы  
 Двери идут в комплекте с замком  
 Внутренняя подсветка в комплекте

Регулируемые ножки из нержавеющей стали  
 Перевешиваемые и самозакрывающиеся  
 двери  
 Покрытые пластиком решетки с размерами  
 530x650 мм  
 Решетки из нержавеющей стали с  
 размерами 530x650 мм (под заказ)



## GN 1/1

### GASTRONORM GN 1/1



GM6 - GB6

Modello Modell Modello Modelo Model Модель	Price	Temperature	Capacity	Refrig. Power	Voltage	Abs. Power	Dimensions	Packing Dim.	Shelves	Ambient Temp.	Weight
	€	°C	Lt	Watt	Volt/Hz	Watt	WxDxH cm	WxDxH cm	N°	°C	kg
GM6		-2° +8°	470	407	220-240/50	330	56x80x212	62x85x228	3	+43	100
GB6		-10° -25°	470	465	220-240/50	477	56x80x212	62x85x228	3	+43	110



### GASTRONORM GN 2/1



GM7 - GB7

GM7G - GB7G

GF7



Modello Modell Modello Modelo Model Модель	Price	Temperature	Capacity	Refrig. Power	Voltage	Abs. Power	Dimensions	Packing Dim.	Shelves	Ambient Temp.	Weight
	€	°C	Lt	Watt	Volt/Hz	Watt	WxDxH cm	WxDxH cm	N°	°C	kg
GM7		-2° +8°	700	375	220-240/50	335	72x80x212	78x85x228	3	+43	120
GM7G		-2° +8°	700	415	220-240/50	440	72x80x212	78x91x228	3	+43	140
GB7		-10° -25°	700	474	220-240/50	510	72x80x212	78x85x228	3	+43	130
GB7G		-10° -25°	700	803	220-240/50	738	72x80x212	78x91x228	3	+43	160
GF7		0° -5°	700	555	220-240/50	443	72x80x212	76x84x228	10 Bac. GN1/1	+43	135



### GASTRONORM GN 2/1



GM7/2 - GB7/2

GM7/GS

Modello Modell Modello Modelo Model Модель	Price	Temperature	Capacity	Refrig. Power	Voltage	Abs. Power	Dimensions	Packing Dim.	Shelves	Ambient Temp.	Weight
	€	°C	Lt	Watt	Volt/Hz	Watt	WxDxH cm	WxDxH cm	N°	°C	kg
GM7-2		-2° +8°	700	375	220-240/50	335	72x80x212	78x85x228	4	+43	120
GB7-2		-10° -25°	700	474	220-240/50	510	72x80x212	78x85x228	4	+43	130
GM7GS		-2° +8°	700	564	220-240/50	477	72x80x212	78x91x228	4	+43	130

## GASTRONORM GN 2/1 Double temp.

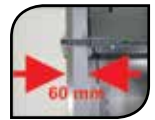

**BLASTFREEZER**

G2M7 - GMB7 - G2B7

GMF7 - GBF7

GM-BF7

Modello Modell Modelo Modelo Модель											
	Price	Temperature	Capacity	Refrig. Power	Voltage	Abs. Power	Dimensions	Packing Dim.	Shelves	Ambient Temp.	Weight
		°C	Lt	Watt	Volt/Hz	Watt	WxDxH cm	WxDxH cm	N°	°C	kg
G2M7		A= -2° +8° B= -2° +8°	350 350	308 308	220-240/50	270 270	72x80x212	78x85x228	4	+43	160
GMB7		A= -2° +8° B= -10° -25°	350 350	308 338	220-240/50	270 363	72x80x212	78x85x228	4	+43	160
G2B7		A= -10° -25° B= -10° -25°	350 350	338 338	220-240/50	363 363	72x80x212	78x85x228	4	+43	160
GMF7		A= -2° +8° B= 0° -5°	350 350	308 387	220-240/50	270 325	72x80x212	78x85x228	2 4 Bac/Trays GN1/1	+43	160
GBF7		A= -10° -25° B= 0° -5°	350 350	338 387	220-240/50	363 325	72x80x212	78x85x228	2 4 Bac/Trays GN1/1	+43	160
GM-BF7		A= +90° -18° B= -10° -25°	350 350		220-240/50		72x80x212	78x85x228		+43	170

## GASTRONORM GN 2/1



GM7-2-C3

GM7G-2-C3

Modello Modell Modelo Modelo Модель											
	Price	Temperature	Capacity	Refrig. Power	Voltage	Abs. Power	Dimensions	Packing Dim.	Shelves	Ambient Temp.	Weight
		°C	Lt	Watt	Volt/Hz	Watt	WxDxH cm	WxDxH cm	N°	°C	kg
GM7-2-C3		-2° +8°	700	375	220-240/50	335	72x80x212	78x85x228	2 Racks 3 CASS	+43	130
GM7G-2-C3		-2° +8°	700	415	220-240/50	440	72x80x212	78x91x228	2 Racks 3 CASS	+43	140



## GASTRONORM GN 2/1

2 porte / door



GM14 - GB14

GM14G - GB14G

GF14



Modello Modell Modelo Model Модель	Price	Temperature	Capacity	Refrig. Power	Voltage	Abs. Power	Dimensions	Packing Dim.	Shelves	Ambient Temp.	Weight
		°C	Lt	Watt	Volt/Hz	Watt	WxDxH cm	WxDxH cm	N°	°C	kg
GM14		-2° +8°	1400	415	220-240/50	440	144x80x212	149x85x228	6	+43	190
GM14G		-2° +8°	1400	929	220-240/50	600	144x80x212	149x91x228	6	+43	235
GB14		-10° -25°	1400	780	220-240/50	755	144x80x212	149x85x228	6	+43	200
GB14G		-10° -25°	1400	1063	220-240/50	1000	144x80x212	149x91x228	6	+43	260
GF14		0° -5°	1400	809	220-240/50	578	144x80x212	149x85x228	20 GN 1/1 Bac./Trays	+43	200

## GASTRONORM GN 2/1



3 porte / door

4 porte / door

4 porte / door



GM14-3 - GB14-3

GM14-4 - GB14-4

GM14-2G2S

Modello Modell Modelo Model Модель	Price	Temperature	Capacity	Refrig. Power	Voltage	Abs. Power	Dimensions	Packing Dim.	Shelves	Ambient Temp.	Weight
		°C	Lt	Watt	Volt/Hz	Watt	WxDxH cm	WxDxH cm	N°	°C	kg
GM14-3		-2° +8°	1400	415	220-240/50	440	144x80x212	149x85x228	7	+43	190
GM14-4		-2° +8°	1400	415	220-240/50	440	144x80x212	149x85x228	8	+43	190
GB14-3		-10° -25°	1400	780	220-240/50	755	144x80x212	149x85x228	7	+43	200
GB14-4		-10° -25°	1400	780	220-240/50	755	144x80x212	149x85x228	8	+43	200
GM14-2G2S		-2° +8°	1400	930	220-240/50	621	144x80x212	149x91x228	8	+43	210
GM14-4G		-2° +8°	1400	930	220-240/50	621	144x80x212	149x91x228	8	+43	230

## GASTRONORM GN 2/1

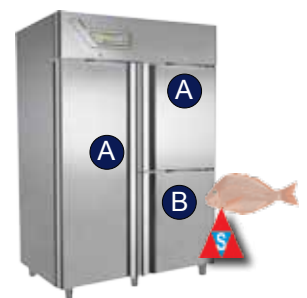
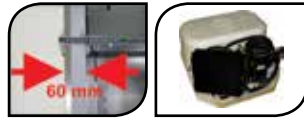

G2M14 - GMB14 - G2B14

GMF14

G2M14-3 - GMB14-3 - G2B14-3

GMF14-3

Modello Model Modell Modelo Model Модель											
	Price	Temperature	Capacity	Refrig. Power	Voltage	Abs. Power	Dimensions	Packing Dim.	Shelves	Ambient Temp.	Weight

### DOPIA TEMPERATURA DOUBLETEMPÉRATURE

	°C	Lt	Watt	Volt/Hz	Watt	WxDxH cm	WxDxH cm	N°	°C	kg
G2M14	A=-2°+8° B=-2°+8°	700 700	375 375	220-240/50	335 335	144x80x212	149x85x228	6	+43	215
GMF14	A=-2°+8° B=0°-5°	700 700	375 575	220-240/50	335 443	144x80x212	149x85x228	6	+43	220
GMB14	A=-2°+8° B=-10°-25°	700 700	375 474	220-240/50	335 510	144x80x212	149x85x228	6	+43	225
G2B14	A=-10°-25° B=-10°-25°	700 700	474 474	220-240/50	510 510	144x80x212	149x85x228	6	+43	225
G2M14-3	A=-2°+8° B=-2°+8°	1050 350	564 308	220-240/50	477 270	144x80x212	149x85x228	7	+43	245
GMF14-3	A=-2°+8° B=0°-5°	1050 350	564 387	220-240/50	477 325	144x80x212	149x85x228	5 4 Bac GN1/1 Trays	+43	245
GMB14-3	A=-2°+8° B=-10°-25°	1050 350	564 338	220-240/50	477 363	144x80x212	149x85x228	7	+43	245
G2B14-3	A=-10°-25° B=-10°-25°	1050 350	583 338	220-240/50	597 363	144x80x212	149x85x228	7	+43	245

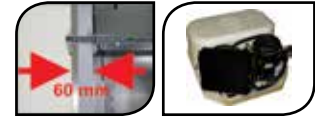

G3M14 - G2MB14 - G3B14 GMBF14 - G2MF14

Modello Model Modell Modelo Model Модель											
	Price	Temperature	Capacity	Refrig. Power	Voltage	Abs. Power	Dimensions	Packing Dim.	Shelves	Ambient Temp.	Weight

### TRIPLA TEMPERATURA TRIPLETEMPERATURE

	°C	Lt	Watt	Volt/Hz	Watt	WxDxH cm	WxDxH cm	N°	°C	kg
G3M14	A=-2°+8° B=-2°+8° C=-2°+8°	700 350 350	375 308 308	220-240/50	335 270 270	144x80x212	149x85x228	7	+43	245
G2MB14	A=-2°+8° B=-2°+8° C=-10°-25°	700 350 350	375 308 338	220-240/50	335 270 363	144x80x212	149x85x228	7	+43	245
GMBF14	A=-2°+8° B=-10°-25° C=0°-5°	700 350 350	375 338 387	220-240/50	335 363 325	144x80x212	149x85x228	5 4 Bac GN1/1 Trays	+43	245
G3B14	A=-10°-25° B=-10°-25° C=-10-25°	700 350 350	474 338 338	220-240/50	510 363 363	144x80x212	149x85x228	7	+43	245
G2MF14	A=-2°+8° B=-2°+8° C=0°-5°	700 350 350	375 308 387	220-240/50	335 270 325	144x80x212	149x85x228	5 4 Bac GN1/1/Trays	+43	245

## GASTRONORM GN 2/1

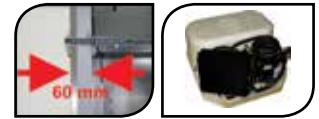

GMB-BF14 - G2M-BF14

GMF-BF14

Modello Modell Modelo Model Модель											
	Price	Temperature	Capacity	Refrig. Power	Voltage	Abs. Power	Dimensions	Packing Dim.	Shelves	Ambient Temp.	Weight

### TRIPLA TEMPERATURA

### TRIPLETEMPERATURE

	°C	Lt	Watt	Volt/Hz	Watt	WxDxH cm	WxDxH cm	N°	°C	kg
GMB-BF14	A= -2° +8°	700	330	220-240/50	335	144x80x212	149x85x228	5	+43	245
	B= +90°-18°	350	1024		1024					
	C= -10°-25°	350	363		363					
G2M-BF14	A= -2° +8°	700	330	220-240/50	335	144x80x212	149x85x228	5	+43	245
	B= +90°-18°	350	1024		1024					
	C= -2° +8°	350	308		270					
GMF-BF14	A= -2° +8°	700	330	220-240/50	335	144x80x212	149x85x228	3 Racks 4 Bac GN1/1Trays	+43	245
	B= +90°-18°	350	1024		1024					
	C= 0° -5°	350	308		270					



G4M14 - G2M2B14 - G4B14 - G3MB14

G3MF14

Modello Modell Modelo Model Модель											
	Price	Temperature	Capacity	Refrig. Power	Voltage	Abs. Power	Dimensions	Packing Dim.	Shelves	Ambient Temp.	Weight

### QUATTROTEMPERATURE

### FOURTEMPERATURE

	°C	Lt	Watt	Volt/Hz	Watt	WxDxH cm	WxDxH cm	N°	°C	kg
G4M14	A= -2°+8°	350	308	220-240/50	270	144x80x212	149x85x228	8	+43	280
	B= -2°+8°	350	308		270					
	C= -2°+8°	350	308		270					
	D= -2°+8°	350	308		270					
G2M2B14	A= -2°+8°	350	308	220-240/50	270	144x80x212	149x85x228	8	+43	280
	B= -2°+8°	350	308		270					
	C= -10°-25°	350	338		363					
	D= -10°-25°	350	338		363					
G4B14	A= -10°-25°	350	338	220-240/50	363	144x80x212	149x85x228	8	+43	280
	B= -10°-25°	350	338		363					
	C= -10°-25°	350	338		363					
	D= -10°-25°	350	338		363					
G3MF14	A= -2°+8°	350	308	220-240/50	270	144x80x212	149x85x228	6 4 Bac GN1/1/ Trays	+43	280
	B= -2°+8°	350	308		270					
	C= -2°+8°	350	308		270					
	D= 0° -5°	350	387		325					
G3MB14	A= -2°+8°	350	308	220-240/50	270	144x80x212	149x85x228	8	+43	280
	B= -2°+8°	350	308		270					
	C= -2°+8°	350	308		270					
	D= -10°-25°	350	338		363					

## GASTRONORM GN 2/1

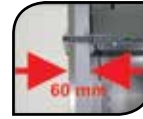

GM21G - GB21G

GM21 - GB21

Modello Model Modell Modelo Model Модель	Price €	Temperature °C	Capacity Lt	Refrig. Power Watt	Voltage Volt/Hz	Abs. Power Watt	Dimensions WxDxH cm	Packing Dim. WxDxH cm	Shelves N°	Ambient Temp. °C	Weight Kg
GM21		-2° +8°	2100	930	220-240/50	600	216x80x212	220x84x228	9	+43	295
GB21		-10° -25°	2100	1063	220-240/50	1000	216x80x212	220x84x228	9	+43	305
GM21G		-2° +8°	2100	1105	220-240/50	800	216x80x212	220x90x228	9	+43	340
GB21G		-10° -25°	2100	2000	220-240/50	1860	216x80x212	220x90x228	9	+43	350

## GASTRONORM GN 2/1

### Frigo Passante / Pass-Through



FRIGO PASSANTE  
SOLID DOOR  
PASS/THRU



FRIGO PASSANTE  
4 SPORTELLI A VETRO  
4 GLASS HALF-DOOR  
PASS/THRU



GM7PT - GMB7PT

GM7PT-4G

Modello Model Modell Modelo Model Модель	Price €	Temperature °C	Capacity Lt	Refrig. Power Watt	Voltage Volt/Hz	Abs. Power Watt	Dimensions WxDxH cm	Packing Dim. WxDxH cm	Shelves N°	Ambient Temp. °C	Weight kg
GM7PT		-2° +8°	700	375	220-240/50	335	72x81,5x212	76x86x228	3	+43	120
GB7PT		-10° -25°	700	474	220-240/50	510	72x81,5x212	76x86x228	3	+43	130
GM7PT-4G		-2° +8°	700	415	220-240/50	440	72x81,5x212	76x98x228	3	+43	170



FRIGO PASSANTE  
SOLID DOOR PASS/THRU



FRIGO PASSANTE  
8 SPORTELLI A VETRO  
8 GLASS HALF-DOOR  
PASS/THRU



GM14PT - GB14PT

GM14PT-8G

Modello Model Modell Modelo Model Модель	Price €	Temperature °C	Capacity Lt	Refrig. Power Watt	Voltage Volt/Hz	Abs. Power Watt	Dimensions WxDxH cm	Packing Dim. WxDxH cm	Shelves N°	Ambient Temp. °C	Weight kg
GM14PT		-2° +8°	1400	415	220-240/50	440	144x81,5x212	148x86x228	6	+43	190
GB14PT		-10° -25°	1400	780	220-240/50	755	144x81,5x212	148x86x228	6	+43	200
GM14PT-8G		-2° +8°	1400	930	220-240/50	621	144x81,5x212	148x98x228	8	+43	260



## GASTRONORM GN 2/1 Embossed Guides



IGM7 - IGB7

IGM7G - IGB7G

Modello Model Modell Modelo Model Модель	Price	Temperature	Capacity	Refrig. Power	Voltage	Abs. Power	Dimensions	Packing Dim.	Shelves	Ambient Temp.	Weight
		°C	Lt	Watt	Volt/Hz	Watt	WxDxH cm	WxDxH cm	N°	°C	kg
IGM7		-2° +8°	700	375	220-240/50	335	68,5x80x212	74x84x228	3	+43	120
IGM7G		-2° +8°	700	415	220-240/50	440	68,5x80x212	74x90x228	3	+43	130
IGB7		-10° -25°	700	474	220-240/50	510	68,5x80x212	74x84x228	3	+43	130
IGB7G		-10° -25°	700	803	220-240/50	738	68,5x80x212	74x90x228	3	+43	150



IGM14 - IGB14

IGM14G - IGB14G

Modello Model Modell Modelo Model Модель	Price	Temperature	Capacity	Refrig. Power	Voltage	Abs. Power	Dimensions	Packing Dim.	Shelves	Ambient Temp.	Weight
		°C	Lt	Watt	Volt/Hz	Watt	WxDxH cm	WxDxH cm	N°	°C	kg
IGM14		-2° +8°	1400	415	220-240/50	440	134x80x212	138x84x228	6	+43	190
IGM14G		-2° +8°	1400	929	220-240/50	600	134x80x212	138x90x228	6	+43	230
IGB14		-10° -25°	1400	780	220-240/50	755	134x80x212	138x84x228	6	+43	200
IGB14G		-10° -25°	1400	1063	220-240/50	1000	134x80x212	138x90x228	6	+43	280



**Guide stampate**  
**Embossed guides**

**Max 24 ripiani per porta**  
**Max 24 racks for each door**

## GASTRONORM GN 2/1



**"Comes flat packed & easy to assemble"**

- SISTEMA SMONTABILE
- FLAT PACK
- SYSTEME DEMONTABLE
- ZERLEGBARES SYSTEM
- SISTEMA DEMONTABLE
- DÜZ PAKETLEME
- СБОРНО - РАЗБОРНАЯ СИСТЕМА

# KNOCKING DOWN

Risparmia sul costo di trasporto con i prodotti Modulari Desmon. Questi prodotti vengono spediti smontati per essere assemblati nel luogo di destinazione. Così i costi di trasporto e di stoccaggio possono essere ridotti sino al 50%. Questi prodotti possono essere installati in aree dove sarebbe molto difficile accedere con prodotti già montati: Possono essere trasportati con facilità pezzo per pezzo ed assemblati nel luogo dove saranno utilizzati

Save on shipping costs with Desmon's Modular Refrigeration. These units are shipped in a flat pack and are not assembled until they arrive at their final destination. This can reduce shipping and storage costs by up to 50%

Install refrigeration units in areas that previously would have been impossible to access. Move your modular units in one piece at a time and build them up where they will be finally used.

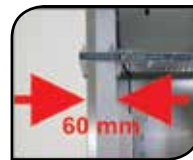

GM7C - GB7C

GM14C - GB14C

GM21C - GB21C

Modello Model Modell Modelo Model Модель	Price €	Temperature °C	Capacity Lt	Refrig. Power Watt	Voltage Volt/Hz	Abs. Power Watt	Dimensions WxDxH cm	Packing Dim. WxDxH cm	Shelves N°	Ambient Temp. °C	Weight Kg
GM7C		-2° +8°	700	375	220-240/50	335	72x80x212	86x78x84 170x78x69	3	+43	120
GB7C		-10° -25°	700	474	220-240/50	510	72x80x212	86x78x84 170x78x69	3	+43	130
GM14C		-2° +8°	1400	415	220-240/50	440	144x80x212	150x86x84 170x78x91	6	+43	190
GB14C		-10° -25°	1400	780	220-240/50	755	144x80x212	150x86x84 170x78x91	6	+43	200
GM21C		-2° +8°	2100	930	220-240/50	600	216x80x212	222x86x84 223x78x114	9	+43	295
GB21C		-10° -25°	2100	1063	220-240/50	1000	216x80x212	222x86x84 223x78x114	9	+43	305

TUBAZIONI NON INCLUDE  
PIPING NOT INCLUDED  
LEITUNGEN NICHT INBEGRIFFEN  
LA TUBATION N'EST PAS INCLUS

## REMOTE COOLING UNITS FOR CABINETS

Unità Refrigeranti Remote - Unité réfrigérante à distance - Kühlaggregat - Unidad refrigerante remota - Uzaktan soğutma sistemi - Выносной холодильный агрегат

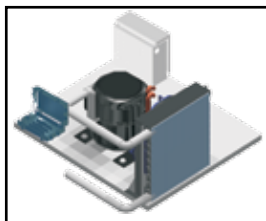

Distanza massima consentita 5 m.  
Maximum standard distance 5 m;  
Distance maximum autorisée 5 m  
Maximale erlaubte Distanz 5 mt.  
Distancia máxima aconsejada 5 m.  
Max standard uzaklık 5 meter  
максимальное стандартное  
расстояние 5 м;

TUBAZIONI NON INCLUDE - PIPING NOT INCLUDED - CANALISATION NON COMPRISE			
UCM350	-2° +8°C	Temp. Positiva (distanza massima 5 m) Positive Temp. (Max length 5 m)	
UCM7	-2° +8°C	Temp. Positiva (distanza massima 5 m) Positive Temp. (Max length 5 m)	
UCM14	-2° +8°C	Temp. Positiva (distanza massima 5 m) Positive Temp. (Max length 5 m)	
UCB350	-10° -25°C	Temp. Negativa (distanza massima 5 m) Negative Temp. (Max length 5 m)	
UCB7	-10° -25°C	Temp. Negativa (distanza massima 5 m) Negative Temp. (Max length 5 m)	
UCB14	-10° -25°C	Temp. Negativa (distanza massima 5 m) Negative Temp. (Max length 5 m)	

### Accessori - Accessories - Accessoires - Zubehör - Accesorios - Seçenekleri - Доп. опция





 Questi accessori possono essere ordinati esclusivamente insieme al prodotto a cui si riferiscono, e non possono essere ordinati separatamente. I prezzi degli accessori, indicati in questo listino, sono solo incrementi e non normali prezzi di vendita. Per ordini separati è necessario consultare il listino ricambi non incluso in questo catalogo.

 Those options are to be ordered only at the moment of ordering a corresponding model and it is impossible to order them separately. The price of the accessories represents only the price increasing and it isn't the accessories price list. To order other accessories, please, check a separate "Spare parts list price".

 Ces accessoires ne peuvent être commandés à ce prix qu'avec le meuble, et ne peuvent pas l'être séparément. Pour commande séparée uniquement d'accessoires, il est nécessaire de consulter le tarif pièces détachées non inclu dans ce catalogue.

 Dieses Zubehör kann nur ausschließlich in Phase der Bestellung des Produktes bestellt werden, auf die sie sich beziehen, und können nicht separat bestellt werden. Für die Bestellung von Ersatzteilen ist der Ersatzteilkatalog zu konsultieren der nicht in diesem Listenpreis beigefügt ist.

 Estos accesorios se pueden ordenar exclusivamente en fase de pedido del producto al que se refieren, y no se pueden pedir separadamente. Los precios de los accesorios, indicados en este listín, son sólo incrementos y no normales precios de venta. Por pedidos separados es necesario consultar el listín accesorios no incluido en este listín.

CABINET WITHOUT COOLING UNITS			
			
Piede inox flangiato S/S flanged foot Pied butée Edelstahl Fuss mit Flansch	Armadio predisposto per unità refrigerante remota Cabinet designed for remote cooling unit Armoires conçu pour unité hermetique à distance Für fern Kühlaggregat vorgesehen	Alimentazione Voltage	Alimentazione Voltage
		220V-60Hz	115V-60Hz (NO ETL-UL)

				
Ruote piroettanti, 2 con freno Lockable castors, 2 with brakes Roulettes pivotantes, 2 avec freins Fussrollen, zwei mit Bremsen Ruedas giratorias, dos con freno Kiiitli Tekertekler, iki Frenli Ножки с колесиками, две – с тормозами	Griglia Inox con Guide inox Stainless Steel shelf with guides Grille acier inox avec glissières Inox Rost mit Schienen Parilla acero Inox con guías Paslanmaz çelik raf raylarla beraber Решетки из нержавеющей стали с направляющими	Kit Griglia plastificata con guide Plastic-coated shelf with guides Grille plastifiée avec glissières Plastifizierter Rost mit Schienen Parilla Plastificada con guías Plastik kapli çelik raf raylarla beraber Пластифицированные решетки с направляющими	Bacinella in plastica alim. GN 1/1 Plastic trays GN 1/1 for food use Bac plastifié GN 1/1 Plastikbehälter GN 1/1 Barreño en plástico GN 1/1 Plastik balik kabi GN 1/1 Пластиковые пищевые контейнеры GN 1/1	Falso fondo in plastica alim. Plastic holed plate Double fond plastifié perforé SieCEI-BBoden Plancha en plástico pinchada Plastik kapli delikli sac Пластиковый перфорированный контейнер
	530x650	530x650		

# UNITED COLORS OF DESMON



RAL



100% Made in Italy



Touch screen con batteria di backup  
Touch screen panel with Backup battery  
Écran tactile avec batterie de secours



Led multicolor con telecomando  
Multicolor Led with remote control  
LED multicolor avec télécommande



RAL

Frontale tipo vetro in tinta (RAL)  
Colored Plexiglass Front Panel (RAL)  
Panneau frontal colorée en plexiglas (RAL)



RAL

Porta a vetro in tinta (RAL)  
Colored Glass door (RAL)  
Porte vitrée en plusieurs couleurs (RAL)





H.A.C.C.P. di serie



H.A.C.C.P. as standard

Spessore da 75 mm su tutta la scocca.



Insulation thickness 75 mm CFC & HCFC free.

Unità refrigerante a monoblocco per sfruttare tutta la capacità di stoccaggio.



Compact Refrigeration System featuring designed to maximise available capacity.

Cruscotto incernierato per consentire facile accesso alle parti elettriche ed all'unità motocondensante.



Hinged control panel for service access

Gurnizioni removibili per una facile pulizia



Wide magnetic gasket gives effective seal and is removable for easy cleaning

Esterno in acciaio inox Aisi 304. A richiesta schienale in acciaio per installazione ad isola.



**AISI 304**

304 Grade in Stainless steel exterior. Complete stainless steel back option for island siting.

Interno in acciaio Aisi 304. Angoli interni arrotondati.



**AISI 304**

Interior Stainless Steel AISI 304. Rounded corner internal for easy cleaning



Serratura di serie



Door lock as standard

Luce LED interna di serie



Interior LED light as standard

**DESMON**

Food Service Equipment

Platinum



# Platinum



Controllo Elettronico  
H.A.C.C.P di serie  
Unità refrigerante a monoblocco  
Sbrinatorio automatico  
Evaporazione automatica  
Gas : R404a

Luce interna di serie  
Isolamento 80 mm privo di CFC/HCFC  
Risparmio Energetico del 20%  
Esterno/Interno in acciaio inox AISI 304  
compreso schienale e fondo esterno  
Angoli interni arrotondati

Serratura con chiavi di serie  
Porte reversibili e autochiudenti



Electronic control  
H.A.C.C.P. as standard  
Compact refrigeration system  
Auto defrost  
Auto evaporation  
Gas: R404a

Polyurethane insulation 80mm  
CFC/HCFC free  
20% saving on energy consumption  
304 Grade Stainless Steel Interior/Exterior  
Interior rounded corner  
Door lock as standard  
Interior Light as standard

Stainless Steel back as standard  
Reversible & Self closing doors



Contrôle électronique  
Contrôle électronique H.A.C.C.P  
Unité réfrigérante compacte  
Dégivrage automatique avec  
réévaporation des eaux  
Gaz: R404a

Isolation épaisseur 80 mm sans CFC/HCFC  
Revêtement Intérieur/extérieur  
en Acier Inox AISI 304  
Angles arrondis intérieurs  
Lumière Intérieure  
Serrure à clé sur chaque porte

Portes réversibles et  
Fermeture automatique



Elektronische Steuerung mit H.A.C.C.P.  
Serienmässig  
Kühlaggregat Monoblockbauweise  
Automatische Abtaug  
Automatische Abtauwasserverdunstung  
Kühlmittel R404a  
Licht Serienmässig

Isolationsstärke 80mm ohne CFC und HCFC  
Energieeinsparung bis zu 20%  
Aussen / Innen Inox (Edelstahl) AISI 304  
Inklusiv Rückwand und Boden aussen  
Intern abgerundete Ecken  
Türschloss Serienmässig  
Türanschlag wechselbar und selbstschliessend



Control electrónico  
H.A.C.C.P en serie  
Unidad refrigerante de tipo monobloque  
Descongelación automática  
Evaporación automática  
Gas: R404a  
Luz interna en serie

Aislamiento 80mm sin CFC/HCFC  
Ahorro energético del 20%  
Externo/interno en acero inox AISI 304  
incluido de respaldo y fondo externo  
Esquinas internas redondeadas  
Cerradura con llaves en serie  
Puertas reversibles y autocerrantes



Elektronik Kontrol  
H.A.C.C.P Fonksiyonu Standart  
Kompakt Soğutma Sistemi  
Otomatik Defrost  
Otomatik Evaporasyon  
Gaz: R 404 A  
Poliüretan İzolasyon 80 mm

CFC/HCFC Free  
Enerji Tüketiminde % 20 Tasarruf  
304 Kalite Paslanmaz Çelik İç ve Dış Gövde  
Yuvarlatılmış İç Köşeler  
Kapı Kilidi Standarttır.  
İç Işıklandırma Standarttır.  
Arka Taraf Paslanmaz Standarttır.

Ayarlanabilir Paslanmaz Ayaklar.  
Yön Değiştirilebilir & Kendinden Kapanan  
Kapılar.



Электронное управление  
функция H.A.C.C.P. в комплекте  
Компактная система охлаждения  
Автоматическое размораживание  
Автоматическое испарение  
Фреон R404a  
Полиуретановый изолирующий слой

80мм без CFC/HCFC  
20%- ая экономия электроэнергии  
Внутренняя отделка из нержавеющей  
стали AISI 304  
Внутренние закругленные углы  
Дверной замок в комплекте  
Внутренняя подсветка в комплекте

Задняя панель из нержавеющей стали в  
комплекте  
Регулируемые ножки из нержавеющей стали  
Перевешиваемые и самозакрывающиеся двери

## ROLL-IN



## ROLL-IN



**TROLLEY NOT INCLUDED  
CARRELLO NON INCLUSO**

PM9RI - PB9RI

PM18RI - PB18RI

Modello Model Modell Modelo Model Модель	Price	Temperature	Capacity	Refrig. Power	Voltage	Abs. Power	Dimensions	Packing Dim.	Trolley	Ambient Temp.	Weight
	€	°C	Lt	Watt	Volt/Hz	Watt	WxDxH cm	WxDxH cm	N°	°C	kg
PM9RI		-2° +10°	1015	564	220-240/50	448	86x96x225	90x110x240	1	+43	200
PB9RI		-10° -25°	1015	583	220-240/50	597	86x96x225	90x110x240	1	+43	205
PM18RI		-2° +10°	2240	930	220-240/50	621	170x96x225	174x110x240	2	+43	290
PB18RI		-10° -25°	2240	1025	220-240/50	1001	170x96x225	174x110x240	2	+43	300

## ROLL-TRHU



**TROLLEY NOT INCLUDED  
CARRELLO NON INCLUSO**

## ROLL-TRHU



PM9RT

PM18RT

Modello Model Modell Modelo Model Модель	Price	Temperature	Capacity	Refrig. Power	Voltage	Abs. Power	Dimensions	Packing Dim.	Trolley	Ambient Temp.	Weight
	€	°C	Lt	Watt	Volt/Hz	Watt	WxDxH cm	WxDxH cm	N°	°C	kg
PM9RT		-2° +10°	1015	564	220-240/50	448	86x96x225	90x110x240	1	+43	210
PM18RT		-2° +10°	2240	930	220-240/50	621	170x96x225	174x110x240	2	+43	310

### Accessori - Accessories - Accessoires - Zubehör - Accesorios - Seçenekleri - Доп. опция

Porta a vetro Glass door Porte Vitré Glastüren Puertas de vidrio Сам Карі Стеклопанель	Oblò 60x40 cm	Carrello GN 2/1 Trolley GN 2/1 Chariot GN 2/1 Rollwagen GN 2/1 Carros GN 2/1 Roll-In GN 2/1 Arabaları Тележка GN 2/1

# Note

A series of horizontal dashed lines for writing notes.



H.A.C.C.P. di serie



H.A.C.C.P. as standard

# Iridinum

Spessore da 75 mm su tutta la scocca.

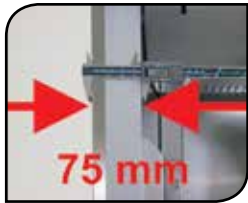

Insulation thickness 75 mm CFC & HCFC free.

Guide stampate.



Embossed guides

Cruscotto incernierato per consentire facile accesso alle parti elettriche ed all'unità motocondensante.



Hinged control panel for service access

Esterno in acciaio inox Aisi 304. A richiesta schienale in acciaio per installazione ad isola.



304 Grade in Stainless steel exterior. Complete stainless steel back option for island siting.

Serratura di serie



Door lock as standard

Luce LED interna di serie



Interior LED light as standard

Unità refrigerante a monoblocco per sfruttare tutta la capacità di stoccaggio.



Compact Refrigeration System featuring designed to maximise available capacity.

Ripiani posizionabili ogni 60mm



Racks adjustable at 60mm intervals

Gurnizioni removibili per una facile pulizia



Wide magnetic gasket gives effective seal and is removable for easy cleaning

Interno in acciaio Aisi 304. Angoli interni arrotondati.



Interior Stainless Steel AISI 304. Rounded corner internal for easy cleaning



# Iridium

Armadi - Reach-ins - Armoires - Kühlschränke - Armarios - Dik Buzdolaplari - Холодильные шкафы



Controllo Elettronico  
H.A.C.C.P di serie  
Unità refrigerante a monoblocco  
Sbrinamento automatico  
Evaporazione automatica  
Gas : R290

Luce interna di serie  
Isolamento 75 mm privo di CFC/HCFC  
Risparmio Energetico del 20%  
Esterno/Interno in acciaio inox AISI 304  
compreso schienale e fondo esterno  
Angoli interni arrotondati

Serratura con chiavi di serie  
Piedini regolabili in Inox  
Porte reversibili e autochiudenti  
Fianchi interni stampati,  
Griglie plastificate dim. 530x650mm  
Griglie inox dim. 530x650mm (Optional)



Electronic control  
H.A.C.C.P. as standard  
Compact refrigeration system  
Auto defrost  
Auto evaporation  
Gas: R290  
Polyurethane insulation 75mm

CFC/HCFC free  
20% saving on energy consumption  
304 Grade Stainless Steel Interior/Exterior  
Interior rounded corner  
Door lock as standard  
Interior Light as standard  
Stainless Steel back as standard

Adjustable Inox feet  
Reversible & Self closing doors  
Embossed guides  
Plastic-coated shelves  
dim. 530x650 mm  
Stainless Steel shelves  
dim. 530x650 mm available on request



Contrôle électronique  
Contrôle électronique H.A.C.C.P  
Unité réfrigérante compacte  
Dégivrage automatique avec  
réévaporation des eaux  
Gaz: R290

Isolation épaisseur 75 mm sans CFC/HCFC  
Revêtement Intérieur/extérieur  
en Acier Inox AISI 304  
Angles arrondis intérieurs  
Lumière Intérieure  
Serrure à clé sur chaque porte

Pieds réglables en Acier Inox 304  
Portes réversibles et  
Fermeture automatique  
Grille Plastifiée dim. 530x650 mm  
Options Grille Inox dim. 530x650 mm



Elektronische Steuerung mit H.A.C.C.P.  
Serienmässig  
Kühlaggregat Monoblockbauweise  
Automatische Abtaug  
Automatische Abtauwasserverdunstung  
Kühlmittel R290  
Licht Serienmässig

Isolationsstärke 75mm ohne CFC und HCFC  
Energieeinsparung bis zu 20%  
Aussen / Innen Inox (Edelstahl) AISI 304  
Inklusiv Rückwand und Boden aussen  
Intern abgerundete Ecken  
Türschloss Serienmässig  
Höhenverstellbare Inoxfüsse

Türanschlag wechselbar und selbstschlies-  
send  
Plastikbeschichtete Roste ABMeßungen  
530x650mm  
Inox (Edelstahl) Roste ABMeßungen  
530x650mm (Optional)



Control electrónico  
H.A.C.C.P en serie  
Unidad refrigerante de tipo monobloque  
Descongelación automática  
Evaporación automática  
Gas: R290  
Luz interna en serie

Aislamiento 75mm sin CFC/HCFC  
Ahorro energético del 20%  
Externo/interno en acero inox AISI 304  
incluido de respaldo y fondo externo  
Esquinas internas redondeadas  
Cerradura con llaves en serie  
Soportes ajustables en Inox

Puertas reversibles y autocerrantes  
Parrillas plastificadas dim. 530 por 650 mm  
Parrillas inox dim. 530 por 650 mm (optional)



Elektronik Kontrol  
H.A.C.C.P Fonksiyonu Standart  
Kompakt Soğutma Sistemi  
Otomatik Defrost  
Otomatik Evaporasyon  
Gaz: R290  
Poliüretan İzolasyon 75 mm

CFC/HCFC Free  
Enerji Tüketiminde % 20 Tasarruf  
304 Kalite Paslanmaz Çelik İç ve Dış Gövde  
Yuvarlatılmış İç Köşeler  
Kapı Kiliti Standarttır.  
İç Işıklandırma Standarttır.  
Arka Taraf Paslanmaz Standarttır.

Ayarlanabilir Paslanmaz Ayaklar.  
Yön Değiştirilebilir & Kendinden Kapanan  
Kapılar.  
Ayarlanabilir Paslanmaz Ayaklar  
Plastik Kaplı Raflar Ölçüsü: 530x650 mm  
İstek Üzerine Paslanmaz Raflar Ölçüsü:  
530x650 mm



Электронное управление  
Функция H.A.C.C.P. в комплекте  
Компактная система охлаждения  
Автоматическое размораживание  
Автоматическое испарение  
Фреон R290  
Полиуретановый изолирующий слой

75мм без CFC/HCFC  
20%- ая экономия электроэнергии  
Внутренняя отделка из нержавеющей  
стали AISI 304  
Внутренние закругленные углы  
Дверной замок в комплекте  
Внутренняя подсветка в комплекте

Задняя панель из нержавеющей стали в  
комплекте  
Регулируемые ножки из нержавеющей стали  
Перевешиваемые и самозакрывающиеся двери  
Покрытые пластиком решетки с размерами  
530x650 мм  
Решетки из нержавеющей стали с размерами  
530x650мм (под заказ)

## Guide stampate

## Embossed guides



IPGM7-IPGB7

IPGM7G-IPGB7G

Modello Model Modell Modelo Model Модель	Price €	Temperature °C	Capacity Lt	Refrig. Power Watt	Voltage Volt/Hz	Abs. Power Watt	Dimensions WxDxH cm	Packing Dim. WxDxH cm	Shelves N°	Ambient Temp. °C	Weight Kg
IPGM7		-2° +8°	700	490	220-240/50	300	68.5x80x212	74x84x228	3	+43	120
IPGM7G		-2° +8°	700	510	220-240/50	350	68.5x80x212	74x90x228	3	+43	130
IPGB7		-10° -25°	700	490	220-240/50	490	68.5x80x212	74x84x228	3	+43	130
IPGB7G		-10° -25°	700	490	220-240/50	490	68.5x80x212	74x90x228	3	+43	135



IPGM14

IPGM14G

IPGB14

Modello Model Modell Modelo Model Модель	Price €	Temperature °C	Capacity Lt	Refrig. Power Watt	Voltage Volt/Hz	Abs. Power Watt	Dimensions WxDxH cm	Packing Dim. WxDxH cm	Shelves N°	Ambient Temp. °C	Weight Kg
IPGM14		-2° +8	1400	800	220-240/50	430	134x80x212	138x84x228	6	+43	190
IPGM14G		-10° -25	1400	920	220-240/50	600	134x80x212	138x90x228	6	+43	230
IPGB14		-10° -25	1400	950	220-240/50	950	134x80x212	138x84x228	6	+43	230



**Guide stampate**  
**Embossed guides**

**Max 24 ripiani per porta**  
**Max 24 racks for each door**



PGM7



PGM7G



PGB7

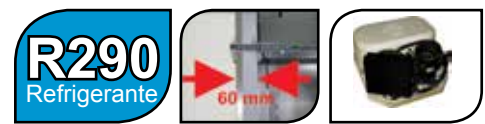

Modello Model Modell Modelo Model Модель	Price	Temperature	Capacity	Refrig. Power	Voltage	Abs. Power	Dimensions	Packing Dim.	Shelves	Ambient Temp.	Weight
	€	°C	Lt	Watt	Volt/Hz	Watt	WxDxH cm	WxDxH cm	N°	°C	kg
PGM7		-2° +8°	700	490	220-240/50	300	72x80x212	76x84x228	3	+43	120
PGM7G		-2° +8°	700	510	220-240/50	350	72x80x212	76x90x228	3	+43	130
PGB7		-10° -25°	700	490	220-240/50	490	72x80x212	76x84x228	3	+43	130



PGM14



PGM14G



PGB14

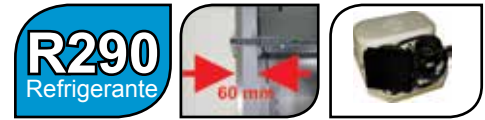

Modello Model Modell Modelo Model Модель	Price	Temperature	Capacity	Refrig. Power	Voltage	Abs. Power	Dimensions	Packing Dim.	Shelves	Ambient Temp.	Weight
	€	°C	Lt	Watt	Volt/Hz	Watt	WxDxH cm	WxDxH cm	N°	°C	kg
PGM14		-2° +8°	1400	800	220-240/50	430	144x80x212	148x84x228	6	+43	190
PGM14G		-10° -25°	1400	920	220-240/50	600	144x80x212	148x90x228	6	+43	230
PGB14		-10° -25°	1400	950	220-240/50	950	144x80x212	148x84x228	6	+43	230



PG2M7



PGMB7



PG2MB7



Modello Model Modell Modelo Model Модель	Price	Temperature	Capacity	Refrig. Power	Voltage	Abs. Power	Dimensions	Packing Dim.	Shelves	Ambient Temp.	Weight
	€	°C	Lt	Watt	Volt/Hz	Watt	WxDxH cm	WxDxH cm	N°	°C	kg
PG2M7		-2° +8°	350	490	220-240/50	280	72x80x212	76x84x228	4	+43	160
		-2° +8°	350								
PGMB7		-2° +8°	350	600	220-240/50	400	72x80x212	76x84x228	4	+43	160
		-10° -25°	350								
PG2MB7		-10° -25°	350	490	220-240/50	480	72x80x212	76x84x228	4	+43	160
		-10° -25°	350								





PG2M14

PGMB14

PG2B14

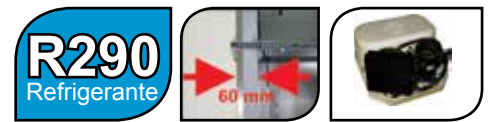

Modello Model Modell Modelo Model Модель	Price €	Temperature °C	Capacity Lt	Refrig. Power Watt	Voltage Volt/Hz	Abs. Power Watt	Dimensions WxDxH cm	Packing Dim. WxDxH cm	Shelves N°	Ambient Temp. °C	Weight kg
PG2M14		-2° +8° -2° +8°	700 700	980	220-240/50	600	144x80x212	148x84x228	6	+43	215
PGMB14		-2° +8° -10° -25°	700 700	980	220-240/50	800	144x80x212	148x84x228	6	+43	225
PG2B14		-10° -25° -10° -25°	700 700	980	220-240/50	980	144x80x212	148x84x228	6	+43	225

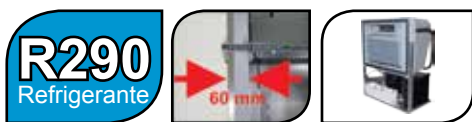

## GASTRONORM GN 1/1 MONOBLOCCO



PTGM2

PTGM3

PTGM4

COMPACT  
REFRIGERATION  
SYSTEM



Modello Model Modell Modelo Model Модель	Price €	Temperature °C	Capacity Lt	Refrig. Power Watt	Voltage Volt/Hz	Abs. Power Watt	Dimensions WxDxH cm	Packing Dim. WxDxH cm	Shelves N°	Ambient Temp. °C	Weight kg
PTGM2		-2° +8°	280	290	220-240/50	200	146x70x85	150x74x100	2	+43	130
PTGM3		-2° +8°	540	360	220-240/50	220	194,5x70x85	198x74x100	3	+43	160
PTGM4		-2° +8°	733	490	220-240/50	300	243x70x85	247x74x100	4	+43	190

## CHEST FREEZER



PF45



Modello Model Modell Modelo Model Модель	Price €	Temperature °C	Capacity Lt	Refrig. Power Watt	Voltage Volt/Hz	Abs. Power Watt	Dimensions WxDxH cm	Packing Dim. WxDxH cm	Shelves N°	Ambient Temp. °C	Weight kg
PF45		-10° -25°		200	220-240/50	200	45x73x99	60x90x120	-	+43	80

## UNITED COLORS OF DESMON



**RAL**

Controllore TOUCH con batteria di backup Touch screen control with Backup battery	Led multicolor con telecomando Multicolor Led with remote control	Frontale tipo vetro in tinta (RAL) Colored Plexiglass Front Panel (RAL)	Porta a vetro in tinta (RAL) Colored Glas door (RAL)

### Accessori - Accessoires - Accessoires - Zubehör - Accesorios - Seçenekleri - Доп. опция

#### TAVOLI REFRIGERATI - REFRIGERATED COUNTERS - MOUBLE RÉFRIGÉRÉ - KÜHLTISCHE MESAS REFRIGERADAS - YATAY BUZDOLAPLARI - ХОЛОДИЛЬНЫЙ СТОЛ

- Questi accessori possono essere ordinati esclusivamente insieme al prodotto a cui si riferiscono, e non possono essere ordinati separatamente. I prezzi degli accessori, indicati in questo listino, sono solo incrementi e non normali prezzi di vendita. Per ordini separati è necessario consultare il listino ricambi non incluso in questo catalogo.
- Those options are to be ordered only at the moment of ordering a corresponding model and it is impossible to order them separately. The price of the accessories represents only the price increasing and it isn't the accessories price list. To order other accessories, please, check a separate "Spare parts list price".
- Dieses Zubehör kann nur ausschließlich in Phase der Bestellung des Produktes bestellt werden, auf die sie sich beziehen, und können nicht separat bestellt werden. Für die Bestellung von Ersatzteilen ist der Ersatzteilkatalog zu konsultieren der nicht in diesem Listenpreis beigefügt ist.

Porta a vetro Glass door Porte Vitre Glastüren Puertas de vidrio Cam Kapı Стеклянная дверь	Piano in granito Granite countertops Comptoirs en granit Granit-Arbeitsplatten Mesada de granito Granit tezgah гранитной столешницей	Cassetto refrigerato su vano motore Refrigerated drawer above the cooling unit Tiroir réfrigéré au dessus du compartiment moteur. Gekühlte Lade auf dem Aggregatfach Cajón refrigerado sobre vano motor Motor boşluğu üzerinde nötr çekmecelik Охлаждаемый ящик над холодильным агрегатом	Cassetto neutro su vano motore Neutral drawer above the cooling unit Tiroir neutre au dessus du compartiment moteur. Ungekühlte Lade auf dem Aggregatfach Cajón neutro sobre vano motor Motor boşluğu üzerinde sogutmalı çekmecelik Нейтральный ящик над холодильным агрегатом

Serratura Door lock Serrure à clé Türschloss Cerradura con llave Kilitlenebilir Kapılar Замок на двери с ключами	Ruote piroettanti, 2 con freno Lockable castors, 2 with brakes Roulettes pivotantes, 2 avec freins Fussrollen, zwei mit Bremsen Ruedas giratorias, dos con freno Kilitli Tekerlekler, iki Frenli Ножи с колесиками, две – с тормозами	Piano con alzatina Splashback Dossieret Arbeitsplatte mit Aufkantung Plano con levantadora Sırtlı Üst Tabla Панель для защиты от брызг	Griglia Inox con Guide inox Stainless Steel shelf with guides Grille acier inox avec glissières Inox Rost mit Schienen Parilla acero Inox con guías Paslanmaz çelik raf raylarla beraber Решетки из нержавеющей стали с направляющими	

# Silver line

Esterno in acciaio inox  
AISI 304/441.



Exterior in Stainless steel  
AISI 304/441

Piano con alzatina  
disponibile su richiesta



Optional angled splashback  
prevents spillage behind the  
counter

Guarnizione amovibili per una  
facile pulizia



Wide magnetic gasket gives  
effective seal and is removable for  
easy cleaning



Griglie Plastificate  
posizionabili ogni 60mm



Trayslide adjustable at  
60mm intervals

H.A.C.C.P. disponibile su  
richiesta



H.A.C.C.P. available on  
request

Interno in acciaio AISI 304.  
Angoli interni arrotondati



304 Grade Stainless Steel  
interior. Rounded corner  
internal for easy cleaning



# Silver



Controllo Elettronico  
Ventilato  
H.A.C.C.P su richiesta  
Sbrinamento automatico  
Evaporazione automatica  
Gas : R404a  
Isolam. da 50 mm senza CFC/HCFC  
Esterno/Interno in acciaio inox AISI

304/441  
Angoli interni arrotondati  
Piedini regolabili in ABS  
Griglie plastificate GN 1/1 dim. 530x325mm  
*Accessori a richiesta:*  
Controllore H.A.C.C.P  
Ruote piroettanti

Serratura con chiavi  
Piedini regolabili in Inox  
Griglie inox dim. 530x325mm  
Piano di lavoro con alzatina  
Cassettiere da 1/3, 1/2, 2/3



Electronic control  
Ventilated  
H.A.C.C.P. function available  
Auto defrost & evaporation  
Gas: R404a  
Polyurethane insulation 50mm CFC & HCFC free

304/441 Grade Stainless Steel Interior/Exterior  
Interior rounded corner  
Adjustable plastic feet  
Plastic-coated shelves  
dim. 530x325 mm  
*Accessories on request*  
Lockable castors, 2 with brakes

Adjustable Inox feet  
Stainless Steel shelves GN 1/1  
Stainless Steel angled splashback  
Drawer set 1/3, 1/2 and 2/3



Contrôle électronique  
Froid ventilé  
Options dispositif digitale H.A.C.C.P  
Dégivrage automatique avec réévaporation des eaux  
Gaz: R404a  
Isolation ép. 50 mm sans CFC/HCFC

Revêtement Intérieur/extérieur  
en Acier Inox AISI 304/441  
Angles arrondis intérieurs  
Pieds réglables en ABS  
Grille Plastifiée dim. 530x650 mm  
En options:  
Roulettes pivotantes, 2 avec freins  
Serrure à clé sur chaque porte

Pieds réglables en Acier Inox 304  
Grille Inox dim. 530x650 mm  
Dossieret  
Bloc de tiroirs de 1/3, 1/2 et 2/3



Elektronische Steuerung  
Umluft  
H.A.C.C.P auf Anfrage  
Automatische Abtaung  
Automatische Abtauwasserverdampfung  
Kühlmittel R404a  
Isolationsstärke 50mm ohne CFC und HCFC

Aussen / Innen Inox Edelstahl AISI 304/441  
Abgerundete Ecken  
öhenverstellbare Plastikfüsse  
Türanschlag wechselbar und selbstschliessend  
Plasikbeschichtete Roste GN 1/1 ABMeßung  
530x325mm  
Zubehör auf Anfrage :  
H.A.C.C.P auf Anfrage

Räder drehbar  
Türschloss  
Füsse Inox  
Roste InoxGN 1/1  
ABMeßung 530x325mm  
Arbeitsplatte mit Aufkantung  
Schubladenblöcke 1/3 – 1/2 – 2/3



Control electrónico ventilado  
H.A.C.C.P. bajo pedido  
Descongelación automática  
Evaporación automática  
Gas:R404a  
Aislamiento desde 50mm sin empleo de CFC y HCFC

Externo/Interno en acero inox AISI 304/441  
Esquinas internas redondeadas  
Soportes ajustables en ABS  
Parrillas plastificadas GN1/1 dim.530por325mm  
Accesorios bajo pedido  
Revisor H.A.C.C.P.  
Ruedas giratorias

Cerradura con llaves  
Soportes ajustables en Inox  
Parrillas inox.dim.530por325mm  
Superficie de trabajo con levantadora  
Cajón desde 1/3, 1/2 y 2/3



Elektronik kontrol  
Fanlı soğutma  
H.A.C.C.P. fonksiyonu opsiyonel  
Otomatik defrost & evaporasyon  
Gaz: R404a  
Poliüretan izolasyon 50 mm CFC & HCFC free  
304/441 Kalite Paslanmaz Çelik İç ve

Dış Gövde  
Yuvarlatılmış İç Köşeler  
Ayarlanabilir Plastik Ayaklar  
Plastik Kaplı Raflar Ölçüsü: 530x325 mm  
İsteğe bağlı aksesuarlar  
Kilitlenebilir tekerlekler, 2 frenli  
Ayarlanabilir Paslanmaz Ayaklar

Paslanmaz Çelik Raflar GN 1/1  
Paslanmaz Çelik Sırtlı Üst Tabla  
Drawer set 1/3, 1/2 and 2/3



Электронное управление  
Вентилируемый  
Доступна функция H.A.C.C.P.  
Автоматическое размораживание и испарение  
Полиуретановая изоляция 50мм без CFC & HCFC free

Внутренняя и внешняя отделка из нержавеющей стали AISI 304/441  
Закругленные внутренние углы  
Регулируемые пластмассовые ножки  
Решетки с размерами 530x325мм покрытые пластиком  
Аксессуары под заказ:

Ножки с колесиками, две с тормозами  
Регулируемые ножки из нержавеющей стали  
Решетки GN 1/1 из нержавеющей стали  
Панель из нержавеющей стали для защиты от брызг  
Наборы выдвижных ящиков 1/3, 1/2 и 2/3



TIM2 - TIB2

TIM3 - TIB3

TIM4 - TIB4

Modello Model Modell Modelo Model Модель	Price €	Temperature °C	Capacity Lt	Refrig. Power Watt	Voltage Volt/Hz	Abs. Power Watt	Dimensions WxDxH cm	Packing Dim. WxDxH cm	Shelves N°	Ambient Temp. °C	Weight kg
TIM2		-2° +8°	226	308	220-240/50	270	131x60x85	135x64x100	2	+43	100
TIM3		-2° +8°	353	407	220-240/50	330	177,5x60x85	182x64x100	3	+43	140
TIM4		-2° +8°	480	407	220-240/50	330	224x60x85	228x64x100	4	+43	170
TIB2		-10° -25°	226	338	220-240/50	363	131x60x85	135x64x100	2	+43	105
TIB3		-10° -25°	353	465	220-240/50	477	177,5x60x85	182x64x100	3	+43	145
TIB4		-10° -25°	480	465	220-240/50	477	224x60x85	228x64x100	4	+43	175

**CONDENSING UNIT  
NOT INCLUDED**

**COUNTER FOR REMOTE COOLING UNIT**

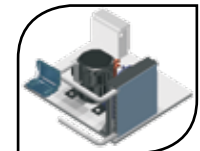

Caratteristiche e prezzi a pag.38  
Prices and features at pag. 38  
Caractéristiques et prix voir page 38



TIM2R - TIB2R

TIM3R - TIB3R

TIM4R - TIB4R

Modello Model Modell Modelo Model Модель	Price €	Temperature °C	Capacity Lt	Refrig. Power Watt	Voltage Volt/Hz	Abs. Power Watt	Dimensions WxDxH cm	Packing Dim. WxDxH cm	Shelves N°	Ambient Temp. °C	Weight kg
TIM2R		-2° +8°	226		220-240/50		105x60x85	110x64x100	2		90
TIM3R		-2° +8°	353		220-240/50		151x60x85	156x64x100	3		135
TIM4R		-2° +8°	480		220-240/50		198x60x85	203x64x100	4		160
TIB2R		-10° -25°	226		220-240/50		105x60x85	110x64x100	2		90
TIB3R		-10° -25°	353		220-240/50		151x60x85	156x64x100	3		135
TIB4R		-10° -25°	480		220-240/50		198x60x85	203x64x100	4		160

**CONDENSING UNIT  
INCLUDED**

**GASTRONORM GN 1/1**



Unità refrigerante incorporata  
Cooling unit included  
Unité réfrigérante incorporée  
Kühlaggregat inbegriffen  
Unidad refrigerante incluida

TSM110

TSM156

TSM203

Modello Model Modell Modelo Model Модель	Price €	Temperature °C	Capacity Lt	Refrig. Power Watt	Voltage Volt/Hz	Abs. Power Watt	Dimensions WxDxH cm	Packing Dim. WxDxH cm	Shelves N°	Ambient Temp. °C	Weight kg
TSM110		-2° +8°	275	308	220-240/50	270	110x70x85	114x74x100	2	+43	120
TSM156		-2° +8°	428	407	220-240/50	330	156x70x85	160x74x100	3	+43	160
TSM203		-2° +8°	581	407	220-240/50	330	203x70x85	207x74x100	4	+43	200

## GASTRONORM GN 1/1



TSM2 - TSB2



TSM3 - TSB3



TSM4 - TSB4

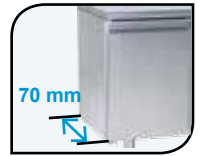

Modello Modell Model Modelo Model Модель	Price €	Temperature °C	Capacity Lt	Refrig. Power Watt	Voltage Volt/Hz	Abs. Power Watt	Dimensions WxDxH cm	Packing Dim. WxDxH cm	Shelves N°	Ambient Temp. °C	Weight kg
TSM2		-2° +8°	275	308	220-240/50	270	131x70x85	135x74x100	2	+43	120
TSM3		-2° +8°	428	407	220-240/50	330	177,5x70x85	182x74x100	3	+43	155
TSM4		-2° +8°	581	407	220-240/50	330	224x70x85	228x74x100	4	+43	185
TSB2		-10° -25°	275	338	220-240/50	363	131x70x85	135x74x100	2	+43	120
TSB3		-10° -25°	428	465	220-240/50	477	177,5x70x85	182x74x100	3	+43	160
TSB4		-10° -25°	581	465	220-240/50	477	224x70x85	228x74x100	4	+43	190

### CONDENSING UNIT NOT INCLUDED

### COUNTER FOR REMOTE COOLING UNIT



TSM2R - TSB2R



TSM3R - TSB3R



TSM4R - TSB4R

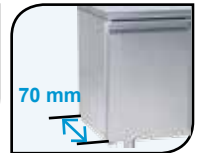
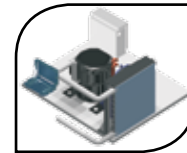

Modello Modell Model Modelo Model Модель	Price €	Temperature °C	Capacity Lt	Refrig. Power Watt	Voltage Volt/Hz	Abs. Power Watt	Dimensions WxDxH cm	Packing Dim. WxDxH cm	Shelves N°	Ambient Temp. °C	Weight kg
TSM2R		-2° +8°	275		220-240/50		105x70x85	110x74x100	2		90
TSM3R		-2° +8°	428		220-240/50		151x70x85	156x74x100	3		135
TSM4R		-2° +8°	581		220-240/50		198x70x85	203x74x100	4		160
TSB2R		-10° -25°	275		220-240/50		105x70x85	110x74x100	2		90
TSB3R		-10° -25°	428		220-240/50		151x70x85	156x74x100	3		135
TSB4R		-10° -25°	581		220-240/50		198x70x85	203x74x100	4		160

## REMOTE COOLING UNITS

TUBAZIONI NON INCLUSE  
PIPING NOT INCLUDED  
LEITUNGEN NICHT INBEGRIFFEN  
LA TUBATION N'EST PAS INCLUS

Unità Refrigeranti Remote - Unité réfrigérante à distance - Kühlaggregat - Unidad refrigerante remota - Uzaktan soğutma sistemi - Выносной холодильный аппарат

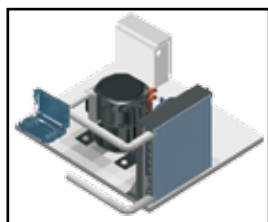

Distanza massima consentita 5 m.  
Maximum standard distance 5 m;  
Distance maximum autorisée 5 m  
Maximale erlaubte Distanz 5 mt.  
Distancia máxima aconsejada 5 m.  
Max standard uzaklık 5 meter  
максимальное стандартное  
расстояние 5 м;  
www.desmon.net

TUBAZIONI NON INCLUSE - PIPING NOT INCLUDED - CANALISATION NON COMPRISE			
UCM2	-2° +8°C	Temp. Positiva (distanza massima 5 m) Positive Temp. (Max length 5 m)	
UCM3	-2° +8°C	Temp. Positiva (distanza massima 5 m) Positive Temp. (Max length 5 m)	
UCM4	-2° +8°C	Temp. Positiva (distanza massima 5 m) Positive Temp. (Max length 5 m)	
UCB2	-10° -25°C	Temp. Negativa (distanza massima 5 m) Negative Temp. (Max length 5 m)	
UCB3	-10° -25°C	Temp. Negativa (distanza massima 5 m) Negative Temp. (Max length 5 m)	
UCB4	-10° -25°C	Temp. Negativa (distanza massima 5 m) Negative Temp. (Max length 5 m)	

## CHEF BASES



TIM260NTV-TIB260LTV

TIM360NTV-TIB360LTV

TIM460NTV-TIB460LTV

Modello Model Modell Modelo Model Модель	Price	Temperature	Capacity	Refrig. Power	Voltage	Abs. Power	Dimensions	Packing Dim.	Shelves	Ambient Temp.	Weight
	€	°C	Lt	Watt	Volt/Hz	Watt	WxDxH cm	WxDxH cm	N°	°C	kg
TIM260NTV		-2° +8°	115	345	220-240/50	260	120x60x60	124x64x70	2	+43	65
TIM360NTV		-2° +8°	180	450	220-240/50	320	160x60x60	164x64x70	3	+43	85
TIM460NTV		-2° +8°	260	630	220-240/50	420	200x60x60	204x64x70	4	+43	92
TIB260LTV		-10° -25°	115	383	220-240/50	398	120x60x60	124x64x70	2	+43	75
TIB360LTV		-10° -25°	180	452	220-240/50	415	160x60x60	164x64x70	3	+43	85
TIB460LTV		-10° -25°	260	650	220-240/50	530	200x60x60	204x64x70	4	+43	110

## CHEF BASES - GASTRONORM GN 1/1

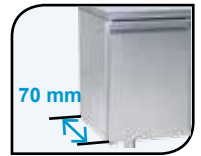

TSM270NTV-TSB270LTV

TSM370NTV-TSB370LTV

TSM470NTV-TSB470LTV

Modello Model Modell Modelo Model Модель	Price	Temperature	Capacity	Refrig. Power	Voltage	Abs. Power	Dimensions	Packing Dim.	Shelves	Ambient Temp.	Weight
	€	°C	Lt	Watt	Volt/Hz	Watt	WxDxH cm	WxDxH cm	N°	°C	kg
TSM270NTV		-2° +8°	135	345	220-240/50	260	120x70x60	124x74x70	2	+43	68
TSM370NTV		-2° +8°	210	450	220-240/50	320	160x70x60	164x74x70	3	+43	88
TSM470NTV		-2° +8°	310	630	220-240/50	420	200x70x60	204x74x70	4	+43	102
TSB270LTV		-10° -25°	135	383	220-240/50	398	120x70x60	124x74x70	2	+43	77
TSB370LTV		-10° -25°	210	452	220-240/50	415	160x70x60	164x74x70	3	+43	97
TSB470LTV		-10° -25°	310	650	220-240/50	530	200x70x60	204x74x70	4	+43	102



SLIM100NTV  
SLIM100LTV

## UNDERCOUNTER CABINETS

- Porta reversibile
- Reversible door
- Porte réversible
- Türanschlag wechselbar
- Puerta reversible
- Yön deđiřtirebilir kapılar
- Перевешиваемая дверь

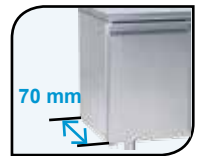

SLIM150NTV  
SLIM150LTV

Modello Model Modell Modelo Model Модель	Price	Temperature	Capacity	Refrig. Power	Voltage	Abs. Power	Dimensions	Packing Dim.	Shelves	Ambient Temp.	Weight
	€	°C	Lt	Watt	Volt/Hz	Watt	WxDxH cm	WxDxH cm	N°	°C	kg
SLIM100NTV		-2° +8°	100	340	220-240/50	217	62,5X60X85	72,5X70X100	1	+43	50
SLIM100LTV		-10° -25°	100	271	220-240/50	279	62,5X60X85	72,5X70X100	1	+43	75
SLIM150NTV		-2° +8°	150	340	220-240/50	217	62,5X70X85	72,5X80X100	1	+43	55
SLIM150LTV		-10° -25°	150	300	220-240/50	279	62,5X70X85	72,5X80X100	1	+43	80

## Accessori - Accessoires - Accessoires - Zubehör - Accesorios - Seçenekleri - Доп. опция

### TAVOLI REFRIGERATI - REFRIGERATED COUNTERS - MOUBLE RÉFRIGÉRÉ - KÜHLTISCHE MESAS REFRIGERADAS - YATAY BUZDOLAPLARI - ХОЛОДИЛЬНЫЙ СТОЛ

Questi accessori possono essere ordinati esclusivamente insieme al prodotto a cui si riferiscono, e non possono essere ordinati separatamente. I prezzi degli accessori, indicati in questo listino, sono solo incrementi e non normali prezzi di vendita. Per ordini separati è necessario consultare il listino ricambi non incluso in questo catalogo.

Those options are to be ordered only at the moment of ordering a corresponding model and it is impossible to order them separately. The price of the accessories represents only the price increasing and it isn't the accessories price list. To order other accessories, please, check a separate "Spare parts list price".

Ces accessoires ne peuvent être commandés à ce prix qu'avec le meuble, et ne peuvent pas l'être séparément. Pour commande séparée uniquement d'accessoires, il est nécessaire de consulter le tarif pièces détachées non inclu dans ce catalogue.

Dieses Zubehör kann nur ausschließlich in Phase der Bestellung des Produktes bestellt werden, auf die sie sich beziehen, und können nicht separat bestellt werden. Für die Bestellung von Ersatzteilen ist der Ersatzteilkatalog zu konsultieren der nicht in diesem Listenpreis beigefügt ist.

Estos accesorios se pueden ordenar exclusivamente en fase de pedido del producto al que se refieren, y no se pueden pedir separadamente. Los precios de los accesorios, indicados en este listín, son sólo incrementos y no normales precios de venta. Por pedidos separados es necesario consultar el listín accesorios no incluido en este listín.

<p><b>H.A.C.C.P.</b></p>			<p><b>GN 1/1 530x325</b></p>	<p>1/2 2/3 1/3</p>
<p>Controllo H. A.C.C.P. H.A.C.C.P. Electronic control Contrôle électronique H.A.C.C.P. Elektronische Steuerung H.A.C.C.P. Control electrónico H.A.C.C.P. Elektronik kontrol H.A.C.C.P. Электронное управление Функция H.A.C.C.P.</p>	<p>Ruote piroettanti, 2 con freno Lockable castors, 2 with brakes Roulettes pivotantes, 2 avec freins Fussrollen, zwei mit Bremsen Ruedas giratorias, dos con freno Döner Tekerlek, 2 frenli Tekerlekler Ножи с колесиками, две – с тормозами</p>	<p>Piano con alzatina Splashback Dossieret Arbeitsplatte mit Aufkantung Plano con levantadora Sırtlı Üst Tabla Панель для защиты от брызг</p>	<p>Griglia Inox GN 1/1 con guide Stainless Steel shelf Grille Acier Inox Rost Inox mit schienen Parilla Inox Inox kaplı çelik raf решетки</p>	<p>0</p> <p>1/3</p> <p>1/2</p> <p>2/3</p>
	<p><b>1/1</b></p>	<p><b>1/2</b></p>	<p><b>460x325</b></p>	<p><b>GN 1/1 530x325</b></p>
<p>Kit piedini inox Adjustable stainless steel feet Pieds réglables en acier inox Höhenverstellbare Inoxfüsse Soportes ajustables en Inox Ayarlanabilir Paslanmaz Ayaklar Регулируемые ножки из нержавеющей стали</p>	<p><b>CHEF BASES</b> Cassetto (1 cassetti da 1/1) Drawer 1/1 Tiroir 1/1 Schublade 1/1 Bandeja de 1/1)</p>	<p><b>CHEF BASES</b> Cassettiera (2 cass. da 1/2) Drawer set Bloc de tiroirs Schubladenblock 1/2 Cajón (2 cajones de ½)</p>	<p>Kit Griglia plastificata con guide Plastic-coated shelf with guide Grille plastifiée Plastifizierter Rost mit Schienen Parilla Plástica Plastik kaplı çelik raf Пластифицированные решетки с направляющими</p>	<p>Kit Griglia plastificata con guide Plastic-coated shelf with guide Grille plastifiée Plastifizierter Rost mit Schienen Parilla Plástica Plastik kaplı çelik raf Пластифицированные решетки с направляющими</p>

	<p><b>220V-60Hz</b></p>	<p><b>115V-60Hz (NO ETL-UL)</b></p>	
<p>Piede inox flangiato S/S flanged foot</p>	<p>Alimentazione Voltage</p>	<p>Alimentazione Voltage</p>	<p>Piano in granito Granite countertops</p>

### RIDUZIONE PER TAVOLO SENZA PIANO - DECREASE OF THE PRICE OF THE TABLES WITHOUT WORKTOP

2 PORTE / 2 DOORS	Tavolo 2 porte senza piano da lavoro - Tables without worktop 2 doors
3 PORTE / 3 DOORS	Tavolo 3 porte senza piano da lavoro - Tables without worktop 3 doors
4 PORTE / 4 DOORS	Tavolo 4 porte senza piano da lavoro - Tables without worktop 4 doors



# CASSETTIERE - DRAWER SET - BLOC DE TIROIRS SCHUBLADENBLÖCKE - CAJÓN

Prodotti acquistabili separatamente  
Products sold separately

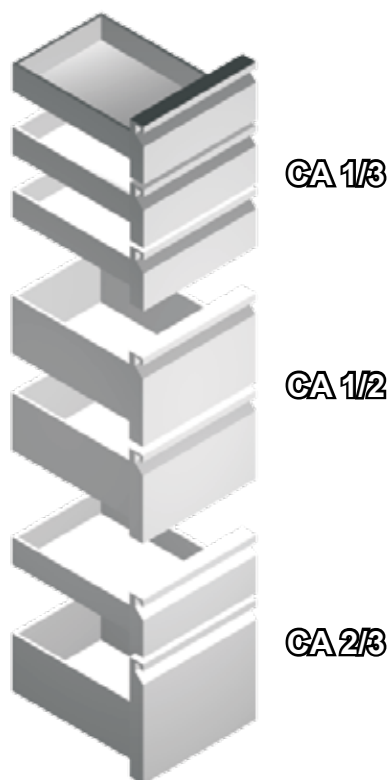

(PIZZA)



Silver



Gold

Modello Model	Descrizione Description	Prezzo Price
------------------	----------------------------	-----------------

## SILVER LINE

CA1/2R	Cassettiera - Drawer set - Bloc de tiroirs - Schubladenblöcke - Cajón Inox GN 1/1	
CA1/2R60	Cassettiera - Drawer set - Bloc de tiroirs - Schubladenblöcke - Cajón Inox prof 60	
CA1/3R	Cassettiera - Drawer set - Bloc de tiroirs - Schubladenblöcke - Cajón Inox GN 1/1	
CA1/3R60	Cassettiera - Drawer set - Bloc de tiroirs - Schubladenblöcke - Cajón Inox prof 60	
CA2/3R	Cassettiera - Drawer set - Bloc de tiroirs - Schubladenblöcke - Cajón Inox GN 1/1	
CA2/3R60	Cassettiera - Drawer set - Bloc de tiroirs - Schubladenblöcke - Cajón Inox prof 60	

## GOLD LINE

J (1/3)	Cassettiera - Drawer set - Bloc de tiroirs - Schubladenblöcke - Cajón Inox GN 1/1	
K (1/2)	Cassettiera - Drawer set - Bloc de tiroirs - Schubladenblöcke - Cajón Inox GN 1/1	
L (2/3)	Cassettiera - Drawer set - Bloc de tiroirs - Schubladenblöcke - Cajón Inox GN 1/1	
KPA (1/2)	Cassettiera - Drawer set - Bloc de tiroirs - Schubladenblöcke - Cajón Inox EU 60x40	

## PIZZA LINE

CATP	Cassettiera - Drawer set - Bloc de tiroirs - Schubladenblöcke - Cajón pizza Silver	
GAPZ	Cassettiera - Drawer set - Bloc de tiroirs - Schubladenblöcke - Cajón pizza High	

# Note

A series of horizontal dashed lines for writing notes.

Semplice e rapida rimozione del cassetto per una facile pulizia



Quick and simple drawer removal for ease of cleaning

Piano con alzatina disponibile su richiesta



Optional angled splashback prevents spillage behind the counter

Guarnizione amovibili per una facile pulizia



Wide magnetic gasket gives effective seal and is removable for easy cleaning

Unità Refrigerante a Monoblocco (seire M)



Compact Refrigeration System (M Series)



Unità refrigerante estraibile per un facile accesso in caso di manutenzione



Slide out refrigeration system for service access

Griglie Plastificate posizionabili ogni 60mm



Trayslide adjustable at 60mm intervals

H.A.C.C.P. di serie



H.A.C.C.P. as standard

Interno / Esterno in acciaio AISI 304. Angoli interni arrotondati



304 Grade Stainless Steel interior / exterior. Rounded corner internal for easy cleaning



**DESMON**  
Food Service Equipment

# Gold



Controllo Elettronico  
H.A.C.C.P di serie  
Unità refrigerante estraibile  
Sbrinamento automatico  
Evaporazione automatica  
Gas : R404a  
Isolamento 60 mm privo di CFC/HCFC

Esterno/Interno in acciaio inox AISI 304  
Angoli interni arrotondati  
Piedini regolabili in Inox  
Porte autochiudenti  
Griglie plastificate dim. 530x650mm  
Accessori a richiesta:  
Griglie inox dim. 530x650mm; Serratura; Ruote;

Piano con alzatina; Cassettiere; Porte a vetro su TN; Cassetto refrigerato o neutro su vano motore;



Electronic control  
H.A.C.C.P. as standard  
Slide out refrigeration system  
Auto defrost & Evaporation  
Gas: R404a  
Polyurethane insulation 60 mm  
CFC/HCFC free

304 Grade Stainless Steel Interior/Exterior  
Interior rounded corner  
Adjustable Inox feet  
Self closing doors  
Plastic-coated shelves  
dim. 530x650 mm  
On request available:

Stainless Steel shelves; Work top whit Splash-back; Door lock; Castors; Drawer kits, Glass door on TN, Refrigerated or neutral drawer above the cooling unit



Contrôle électronique  
Contrôle électronique H.A.C.C.P  
Unité hermétique extractible sur glissières  
Dégivrage automatique avec réévaporation des eaux  
Gaz: R404a

Isolation épaisseur 60 mm sans CFC/HCFC  
Revêtement Intérieur/extérieur en Acier Inox AISI 304  
Angles arrondis intérieur  
Pieds réglables en Acier Inox 304  
Portes avec fermeture automatique  
Grille Plastifiée dim. 530x650 mm

Options:  
Grille Inox, Serrure à clef, Porte a vitré sur table frigorifique, dossieret, Bloc de tiroirs, Tiroir réfrigéré ou neutre au dessus du compartiment moteur.



Elektronische Steuerung  
H.A.C.C.P auf Anfrage  
Automatische Abtauung  
Automatische Abtauwasserverdampfung  
Kühlmittel R404a  
Isolationsstärke 60mm ohne CFC und

HCFC  
Aussen / Innen Inox (Edelstahl) AISI 304  
Intern abgerundete Ecken Reinigungsfreundlich  
Höhenverstellbare Inoxfüsse  
Tür selbstschliessend  
Plastikbeschichtete Roste GN 1/1 ABMessung 530x325mm

Zubehör auf Anfrage :  
Roste InoxGN 1/1 ABMessung 530x325mm  
Türschloss - Räder drehbar - Arbeitsplatte mit Aufkantung - Schubladenblöcke 1/3 - 1/2 - 2/3 - Glastüren nur Normaltemperatur - Gekühlte oder Ungekühlte Lade auf dem Aggregatfach



Control electrónico  
H.A.C.C.P. en serie  
Unidad refrigerante extraíble  
Descongelación automática  
Evaporación automática  
Gas:R404a

Aislamiento 60mm sin empleo de CFC y HCFC  
Externo/Interno en acero inox AISI 304  
Esquinas internas redondeadas  
Soportes ajustables en Inox  
Puertas autocerrantes  
Parrillas plastificadas dim. 530por650mm  
Accesorios bajo pedido

Parrillas inox.dim.530por650mm; Cerradura; Ruedas; Superficie con levantadora; Cajón; Puertas de vidrio sobre TN; Cajón refrigerado o neutro sobre vano motor



Elektronik kontrol  
H.A.C.C.P. fonksiyonu standart  
Kayarak Çıkartılabilir refrigeration system  
Otomatik defrost & evaporasyon  
Gaz: R404a  
Poliüretan izolasyon 60 mm

CFC/HCFC free  
304 Kalite Paslanmaz Çelik İç ve Dış Gövde  
Yuvarlatılmış İç Köşeler  
Ayarlanabilir Paslanmaz Ayaklar  
Kendinden Kapanan Kapılar  
Plastik Kaplı Raflar Ölçüsü: 530x650 mm  
İsteğe bağlı olarak:

Paslanmaz Çelik Raflar; Sırtlı Üst Tabla; Kapı Kilidi; Tekerlekler; Çekmece takımları, Normal Dolaplarda Cam Kapı, soğutma ünitesinin üzerinde soğutuculu veya nötr çekmece



Электронное управление  
Функция H.A.C.C.P. в комплекте  
Выдвижная система охлаждения  
Автоматическое размораживание и испарение  
Фреон R404a  
Полиуретановый изолирующий слой 60мм, без CFC/HCFC

Внешняя и внутренняя отделка из нержавеющей стали AISI 304  
Закругленные внутренние углы  
Регулируемые ножки из нержавеющей стали  
Самозакрывающиеся двери  
Решетки 530x650мм покрытые пластиком  
Дополнительно заказываются:

Решетки из нержавеющей стали, рабочая поверхность с панелью для защиты от брызг, замок на двери, ножки с колесиками, набор выдвижных ящиков, стеклянная дверь для TN, охлаждаемый или нейтральный выдвижной ящик над холодильным агрегатом

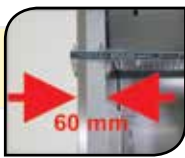

# Gold



## GASTRONORM GN 1/1



TGM100  
TGB100

TGM2 - TGB2

TGM3 - TGB3

TGM4 - TGB4

TGM5

Modello Model Modell Modelo Model Модель	Price €	Temperature °C	Capacity Lt	Refrig. Power Watt	Voltage Volt/Hz	Abs. Power Watt	Dimensions WxDxH cm	Packing Dim. WxDxH cm	Shelves N°	Ambient Temp. °C	Weight kg
TGM100		-2° +8°	120	308	220-240/50	270	97x70x85	101x74x100	1	+43	115
TGM2		-2° +8°	280	308	220-240/50	270	146x70x85	150x74x100	2	+43	130
TGM3		-2° +8°	441	407	220-240/50	330	194,5x70x85	198x74x100	3	+43	160
TGM4		-2° +8°	602	564	220-240/50	448	243x70x85	247x74x100	4	+43	190
TGM5		-2° +8°	993	700	220-240/50	550	291,5x70x85	296x74x100	5	+43	250
TGB100		-10° -25°	120	555	220-240/50	443	97x70x85	101x74x100	1	+43	120
TGB2		-10° -25°	280	338	220-240/50	363	146x70x85	149x74x100	2	+43	135
TGB3		-10° -25°	441	465	220-240/50	477	194,5x70x85	198x74x100	3	+43	170
TGB4		-10° -25°	602	465	220-240/50	477	243x70x85	247x74x100	4	+43	200

### MONOBLOCCO

## GASTRONORM GN 1/1 - M SERIES



COMPACT  
REFRIGERATION  
SYSTEM



TGM2M - TGB2M

TGM3M - TGB3M

TGM4M

Modello Model Modell Modelo Model Модель	Price €	Temperature °C	Capacity Lt	Refrig. Power Watt	Voltage Volt/Hz	Abs. Power Watt	Dimensions WxDxH cm	Packing Dim. WxDxH cm	Shelves N°	Ambient Temp. °C	Weight kg
TGM2M		-2° +8°	280	308	220-240/50	270	146x70x85	150x74x100	2	+43	130
TGM3M		-2° +8°	540	407	220-240/50	330	194,5x70x85	198x74x100	3	+43	160
TGM4M		-2° +8°	733	564	220-240/50	448	243x70x85	247x74x100	4	+43	190
TGB2M		-10° -25°	280	338	220-240/50	363	146x70x85	150x74x100	2	+43	140
TGB3M		-10° -25°	540	465	220-240/50	477	194,5x70x85	198x74x100	3	+43	170

## GASTRONORM GN 1/1

### FRIGOPASSANTE/PASS-THRU FRIGO TRAVERSANT



TGM2PT - TGB2PT

TGM3PT - TGB3PT

TGM4PT - TGB4PT

Modello Model Modell Modelo Model Модель	Price €	Temperature °C	Capacity Lt	Refrig. Power Watt	Voltage Volt/Hz	Abs. Power Watt	Dimensions WxDxH cm	Packing Dim. WxDxH cm	Shelves N°	Ambient Temp. °C	Weight kg
TGM2PT		-2° +8°	280	308	220-240/50	270	146x75x85	150x79x100	2	+43	130
TGM3PT		-2° +8°	441	407	220-240/50	330	194,5x75x85	198x79x100	3	+43	160
TGM4PT		-2° +8°	602	564	220-240/50	448	243x75x85	247x79x100	4	+43	190

## GASTRONORM GN 1/1 DUAL TEMPERATURE BI-TEMPERATURE



TGMB4



Modello Modell Modell Modelo Model Модель	Price €	Temperature °C	Capacity Lt	Refrig. Power Watt	Voltage Volt/Hz	Abs. Power Watt	Dimensions WxDxH cm	Packing Dim. WxDxH cm	Shelves N°	Ambient Temp. °C	Weight kg
TGMB4		-2° +8° -10° -25°	280 280	308 338	220-240/50	270 363	243x70x85	247x74x100	4	+43	190

**COOLING UNIT  
NOT INCLUDED**

## COUNTERS FOR REMOTE COOLING UNIT TAVOLI CON UNITÀ REFRIGERANTE REMOTA



TGM2R-TGB2R



TGM3R-TGB3R



TGM4R-TGB4R



TGM5R

Modello Modell Modell Modelo Model Модель	Price €	Temperature °C	Capacity Lt	Refrig. Power Watt	Voltage Volt/Hz	Abs. Power Watt	Dimensions WxDxH cm	Packing Dim. WxDxH cm	Shelves N°	Ambient Temp. °C	Weight kg
TGM2R		-2° +8°	280	-	220-240/50	-	109x70x85	113x74x100	2	+43	90
TGM3R		-2° +8°	441	-	220-240/50	-	157,5x70x85	162x74x100	3	+43	135
TGM4R		-2° +8°	602	-	220-240/50	-	206x70x85	210x74x100	4	+43	160
TGM5R		-2° +8°	993	-	220-240/50	-	254,5x70x85	260x74x100	5	+43	200
TGB2R		-10° -25°	280	-	220-240/50	-	109x70x85	113x74x100	2	+43	90
TGB3R		-10° -25°	441	-	220-240/50	-	157,5x70x85	162x74x100	3	+43	135
TGB4R		-10° -25°	602	-	220-240/50	-	206x70x85	210x74x100	4	+43	160

## REMOTE COOLING UNITS

**TUBAZIONI NON INCLUDE  
PIPING NOT INCLUDED  
LEITUNGEN NICHT INBEGRIFFEN  
LA TUBATION N'EST PAS INCLUS**

Unità Refrigeranti Remote - Unité réfrigérante à distance - Kühlaggregat - Unidad refrigerante remota - Uzaktan soğutma sistemi - Выносной холодильный аппарат

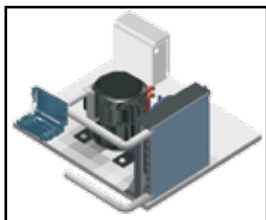

Distanza massima consentita 5 m.  
Maximum standard distance 5 m;  
Distance maximum autorisée 5 m  
Maximale erlaubte Distanz 5 mt.  
Distancia máxima aconsejada 5 m.  
Max standard uzaklık 5 meter  
максимальное стандартное  
расстояние 5 м;  
www.desmon.net

TUBAZIONI NON INCLUDE - PIPING NOT INCLUDED - CANALISATION NON COMPRISE			
UCM2	-2° +8°C	Temp. Positiva (distanza massima 5 m) Positive Temp. (Max length 5 m)	
UCM3	-2° +8°C	Temp. Positiva (distanza massima 5 m) Positive Temp. (Max length 5 m)	
UCM4	-2° +8°C	Temp. Positiva (distanza massima 5 m) Positive Temp. (Max length 5 m)	
UCB2	-10° -25°C	Temp. Negativa (distanza massima 5 m) Negative Temp. (Max length 5 m)	
UCB3	-10° -25°C	Temp. Negativa (distanza massima 5 m) Negative Temp. (Max length 5 m)	
UCB4	-10° -25°C	Temp. Negativa (distanza massima 5 m) Negative Temp. (Max length 5 m)	

## GASTRONORM GN 1/1

"Comes flat packed & easy to assemble"



- SISTEMA SMONTABILE
- FLAT PACK
- SYSTEME DEMONTABLE
- ZERLEGBAR PANEELBAUWEISE
- SISTEMA DEMONTABLE
- DÜZ PAKETLEME
- СБОРНО-РАЗБОРНАЯ СИСТЕМА

TGM2C-TGB2C

# KNOCKING DOWN

Risparmia sul costo di trasporto con i prodotti Modulari Desmon. Questi prodotti vengono spediti smontati per essere assemblati nel luogo di destinazione. Così i costi di trasporto e di stoccaggio possono essere ridotti sino al 50%. Questi prodotti possono essere installati in aree dove sarebbe molto difficile accedere con prodotti già montati: Possono essere trasportati con facilità pezzo per pezzo ed assemblati nel luogo dove saranno utilizzati

Save on shipping costs with Desmon's Modular Refrigeration. These units are shipped in a flat pack and are not assembled until they arrive at their final destination. This can reduce shipping and storage costs by up to 50%  
Install refrigeration units in areas that previously would have been impossible to access. Move your modular units in one piece at a time and build them up where they will be finally used.

### CARATTERISTICHE

- Facili da trasportare e da assemblare
- Interno ed esterno realizzato in Acciaio AISI 304
- Angoli interni arrotondati per una facile pulizia ed una perfetta igiene
- 60 mm di spessore sull'intera scocca
- H.A.C.C.P. di serie su tutti i modelli

### STANDARD FEATURES AND BENEFITS:

- Comes flat packed and easy to assemble
- Both external and internal surfaces are constructed from Stainless Steel AISI 304
- Internal covered Stainless Steel surface allows for easy cleaning and maintenance
- 60mm high density polyurethane foam insulation (CFC & HCFC Free)
- Constructed with kitchen efficiency in mind
- All High Line Refrigeration comes standard with H.A.C.C.P. system



TGM2C-TGB2C



TGM3C-TGB3C









TGM4C-TGB4C



**KIT SYSTEM  
DÉMONTABLE**

Modello Model Modell Modelo Model Модель	Price €	Temperature °C	Capacity Lt	Refrig. Power Watt	Voltage Volt/Hz	Abs. Power Watt	Dimensions WxDxH cm	Packing Dim. WxDxH cm	Shelves N°	Ambient Temp. °C	Weight Kg
TGM2C		-2° +8°	280	308	220-240/50	270	146x70x85	65x77x106 152x76x59	2	+43	130
TGM3C		-2° +8°	441	407	220-240/50	330	194,5x70x85	65x77x106 200x76x61	3	+43	160
TGM4C		-2° +8°	602	564	220-240/50	448	243x70x85	65x77x106 249x76x65	4	+43	190
TGB2C		-10° -25°	280	338	220-240/50	363	146x70x85	65x77x106 152x76x59	2	+43	135
TGB3C		-10° -25°	441	465	220-240/50	477	194,5x70x85	65x77x106 200x76x61	3	+43	170
TGB4C		-10° -25°	602	465	220-240/50	477	243x70x85	65x77x106 249x76x65	4	+43	200

## Accessori - Accessories - Accessoires - Zubehör - Accesorios - Seçenekleri - Доп. опция

TAVOLI REFRIGERATI - REFRIGERATED COUNTERS - MOUBLE RÉFRIGÉRÉ - KÜHLTISCHE  
MESAS REFRIGERADAS - YATAY BUZDOLAPLARI - ХОЛОДИЛЬНЫЙ СТОЛ

-  Questi accessori possono essere ordinati esclusivamente insieme al prodotto a cui si riferiscono, e non possono essere ordinati separatamente. I prezzi degli accessori, indicati in questo listino, sono solo incrementi e non normali prezzi di vendita. Per ordini separati è necessario consultare il listino ricambi non incluso in questo catalogo.
-  Those options are to be ordered only at the moment of ordering a corresponding model and it is impossible to order them separately. The price of the accessories represents only the price increasing and it isn't the accessories price list. To order other accessories, please, check a separate "Spare parts list price".
-  Dieses Zubehör kann nur ausschließlich in Phase der Bestellung des Produktes bestellt werden, auf die sie sich beziehen, und können nicht separat bestellt werden. Für die Bestellung von Ersatzteilen ist der Ersatzteilkatalog zu konsultieren der nicht in diesem Listenpreis beigefügt ist.
-  Estos accesorios se pueden ordenar exclusivamente en fase de pedido del producto al que se refieren, y no se pueden pedir separadamente. Los precios de los accesorios, indicados en este listín, son sólo incrementos y no normales precios de venta. Por pedidos separados es necesario consultar el listín accesorios no incluido en este listín.
-  Buu katalogda gösterilen aksesuar fiyatları sadece katalog fiyatlarıdır, normal satış fiyatları değildir. Ayrı siparişler için, bu kataloga dahil olmayan Yedek Parça Fiyat Listesi kullanılmalıdır.
-  Эти аксессуары должны быть заказаны вместе с основными моделями и не могут поставляться отдельно. В случае заказа этих опций к цене основной модели надо будет добавить цену опции. Для заказа остальных аксессуаров и запасных частей, пожалуйста, смотрите отдельный прайс-лист «аксессуары».

			 <b>220V-60Hz</b>	 <b>115V-60Hz (NO ETL-UL)</b>
Piede inox flangiato S/S flanged foot	Lavello 33x33 cm Sink 33x33 cm	Rubinetto miscelatore Mixer tap	Alimentazione Voltage	Alimentazione Voltage

		 	
Porta a vetro Glass door Porte Vitré Glastüren Puertas de vidrio Cam Kapı Стеклянная дверь	Piano in granito Granite countertops Comptoirs en granit Granit-Arbeitsplatten Mesada de granito Granit tezgah гранитной столешницей	Cassetto refrigerato su vano motore Refrigerated drawer above the cooling unit Tiroir réfrigéré au dessus du compartiment moteur. Gekühlte Lade auf dem Aggregatfach Cajón refrigerado sobre vano motor Motor boşluğu üzerinde nötr çekmecelik Охлаждаемый ящик над холодильным агрегатом	Cassetto neutro su vano motore Neutral drawer above the cooling unit Tiroir neutre au dessus du compartiment moteur. Ungekühlte Lade auf dem Aggregatfach Cajón neutro sobre vano motor Motor boşluğu üzerinde sogutmalı çekmecelik Нейтральный ящик над холодильным агрегатом

 <b>GN 1/1 530x325</b>			 <b>GN 1/1 530x325</b>	 <b>2/3 1/3 1/2</b>
Kit Griglia plastificata con guide Plastic-coated shelf with guide Grille plastifiée Plastifizierter Rost mit Schienen Parilla Plástica Plastik kaplı çelik raf Пластифицированные решетки с направляющими	Ruote piroettanti, 2 con freno Lockable castors, 2 with brakes Roulettes pivotantes, 2 avec freins Fussrollen, zwei mit Bremsen Ruedas giratorias, dos con freno Kilitli Tekerlekler, iki Frenli Ножи с колесиками, две – с тормозами	Piano con alzatina Splashback Dosseret Arbeitsplatte mit Aufkantung Plano con levantadora Sırtlı Üst Tabla Панель для защиты от брызг	Griglia Inox con Guide inox Stainless Steel shelf with guides Grille acier inox avec glissières Inox Rost mit Schienen Parilla acero Inox con guías Paslanmaz çelik raf raylarla beraber Решетки из нержавеющей стали с направляющими	 <b>1/3</b> <b>1/2</b> <b>2/3</b>





**PASTRY LINE  
PASTICCERIA**

## Armadi - Reach-ins - Armoires - Kühlschränke - Armarios - Dik Buzdolaplari - Холодильные шкафы



Controllo Elettronico  
H.A.C.C.P di serie  
Unità refrigerante a monoblocco  
Sbrinatorio automatico  
Evaporazione automatica  
Gas : R404a

Luce interna di serie  
Isolamento 60 mm privo di CFC/HCFC  
Risparmio Energetico del 20%  
Esterno/Interno in acciaio inox AISI 304  
Angoli interni arrotondati  
Serratura con chiavi di serie

Piedini regolabili in Inox  
Porte reversibili e autochiudenti  
Griglie plastificate dim. 530x650mm  
Griglie inox dim. 530x650mm (Optional)



Electronic control  
H.A.C.C.P. as standard  
Compact refrigeration system  
Auto defrost  
Auto evaporation  
Gas: R404a

Polyurethane insulation 60 mm  
CFC/HCFC free  
20% saving on energy consumption  
304 Grade Stainless Steel Interior/Exterior  
Interior rounded corner  
Door lock as standard  
Interior Light as standard

Adjustable Inox feet  
Reversible & Self closing doors  
Plastic-coated shelves  
dim. 530x650 mm  
Stainless Steel shelves  
dim. 530x650 mm available on request



Contrôle électronique  
Contrôle électronique H.A.C.C.P  
Unité réfrigérante compacte  
Dégivrage automatique avec  
réévaporation des eaux  
Gaz: R404a

Isolation épaisseur 60 mm sans CFC/HCFC  
Revêtement Intérieur/extérieur  
en Acier Inox AISI 304  
Angles arrondis intérieur  
Lumière Intérieure  
Serrure à clé sur chaque porte

Pieds réglables en Acier Inox 304  
Portes réversibles et  
Fermeture automatique  
Grille Plastifiée dim. 530x650 mm  
Options Grille Inox dim. 530x650 mm



Elektronische steuerung  
H.A.C.C.P Serienmässig  
Kühlaggregat Monoblockbauweise  
Automatische Abtaug  
Automatische Abtauwasserverdunstung  
Kühlmittel R404a  
Licht Serienmässig

Isolationsstärke 60mm ohne CFC und HCFC  
Energieeinsparung bis zu 20%  
Aussen / Innen Inox (Edelstahl) AISI 304  
Intern abgerundete Ecken  
Türschloss Serienmässig  
Höhenverstellbare Inoxfüsse  
Türanschlag wechselbar - Selbstschliessend

Plastikbeschichtete Roste ABmessungen  
530x650mm  
Inox (Edelstahl) Roste ABmessungen  
530x650mm (Optional)



Control electrónico  
H.A.C.C.P. de serie  
Unidad refrigerante monobloque  
Descongelación automática  
Evaporación automática  
Gas: R404a

Luz interna de serie  
Aislamiento 60mm sin empleo de CFC/HCFC  
Ahorro energético del 20%  
Externo/Interno en acero inox AISI 304  
Esquinas internas redondeadas  
Cerradura con llaves de serie  
Soportes ajustables en Inox

Puertas reversibles y autocerrantes  
Parrillas plastificadas dim.530 por 650mm  
Parrillas inox dim.530 por 650 mm (optional)



H.A.C.C.P Fonksiyon Standart  
Kompak Soğutma Sistemi  
Otomatik Defrost  
Otomatik Evaporasyon  
Gaz: R 404 A  
Poliüretan İzolasyon 60 mm  
CFC/HCFC Free

Enerji Tüketiminde % 20 Tasarruf  
304 Kalite Paslanmaz Çelik Dış ve İç Gövde  
Yuvarlatılmış İç Köşeler  
Kapıda Kilit Standarttır  
İç Işıklandırma Standarttır  
Ayarlanabilir Paslanmaz Ayaklar  
Yön Değiştirilebilir & Kendinden Kapanan Kapılar

Plastik Kaplı Raflar Ölçüsü: 530x560 mm  
İstek Üzerine Paslanmaz Çelik Raflar Ölçüsü:  
530x560 mm



Электронное управление  
Функция H.A.C.C.P. в комплекте  
Компактная система охлаждения  
Автоматическое размораживание  
Автоматическое испарение  
Фреон R404a  
Полууретановый изолирующий слой

60мм без CFC/HCFC  
20%- ая экономия электроэнергии  
внешняя и внутренняя отделка из нержавеющей  
стали AISI 304  
Внутренние закругленные углы  
Двери идут в комплекте с замком  
Внутренняя подсветка в комплекте

Регулируемые ножки из нержавеющей  
стали  
Перевешиваемые и самозакрывающиеся  
двери  
Покрытые пластиком решетки с размерами  
530x650 мм  
Решетки из нержавеющей стали с  
размерами 530x650 мм (под заказ)



# Gold Pastry



EURONORM



Trayslide adjustable at 60mm intervals. Max 20 bakery pan not included



GPM6 - GPB6 GPM7 - GPB7 GPM7G - GPB7G

Modello Model Modell Modelo Model Модель	Price	Temperature	Capacity	Refrig. Power	Voltage	Abs. Power	Dimensions	Packing Dim.	S/S Guides "L" shape	Ambient Temp.	Weight
	€	°C	Lt	Watt	Volt/Hz	Watt	WxDxH cm	WxDxH cm	N°	°C	kg
GPM6		-2° +8°	470	564	220-240/50	448	56x80x212	62x85x228	20	+43	110
GPB6		-10° -25°	470	465	220-240/50	477	56x80x212	62x85x228	20	+43	120
GPM7		-2° +8°	700	564	220-240/50	477	72x80x212	78x85x228	20	+43	130
GPM7G		-2° +8°	700	564	220-240/50	477	72x80x212	78x85x228	20	+43	145
GPB7		-10° -25°	700	465	220-240/50	477	72x80x212	78x85x228	20	+43	140
GPB7G		-10° -25°	700	583	220-240/50	597	72x80x212	78x85x228	20	+43	150



600x800  
(2 x 600x400)



GPM9 - GPB9

Modello Model Modell Modelo Model Модель	Price	Temperature	Capacity	Refrig. Power	Voltage	Abs. Power	Dimensions	Packing Dim.	S/S Guides "L" shape	Ambient Temp.	Weight
	€	°C	Lt	Watt	Volt/Hz	Watt	WxDxH cm	WxDxH cm	N°	°C	kg
GPM9		-2° +8°	840	564	220-240/50	454	88X100X210	92X104X225	22	+43	170
GPB9		-10° -25°	840	465	220-240/50	483	88X100X210	92X104X225	22	+43	170



GPM14 - GPB14 GPM14G - GPB14G

Modello Model Modell Modelo Model Модель	Price	Temperature	Capacity	Refrig. Power	Voltage	Abs. Power	Dimensions	Packing Dim.	S/S Guides "L" shape	Ambient Temp.	Weight
	€	°C	Lt	Watt	Volt/Hz	Watt	WxDxH cm	WxDxH cm	N°	°C	kg
GPM14		-2° +8°	1400	930	220-240/50	621	144x80x212	149x85x228	40	+43	195
GPM14G		-2° +8°	1400	930	220-240/50	621	144x80x212	149x85x228	40	+43	235
GPB14		-10° -25°	1400	583	220-240/50	597	144x80x212	149x85x228	40	+43	210
GPB14G		-10° -25°	1400	1025	220-240/50	1001	144x80x212	149x85x228	40	+43	250



# Gold

 <b>Controllo Elettronico</b> H.A.C.C.P di serie Unità refrigerante estraibile Sbrinamento automatico Evaporazione automatica Gas : R404a Isolamento 60 mm privo di CFC/HCFC	Esterno/Interno in acciaio inox AISI 304 Angoli interni arrotondati Piedini regolabili in Inox Porte autochiudenti Griglie plastificate dim. 530x650mm Accessori a richiesta: Griglie inox dim. 530x650mm; Serratura; Ruote;	Piano con alzatina; Cassettiere; Porte a vetro su TN; Cassetto refrigerato o neutro su vano motore;
 <b>Electronic control</b> H.A.C.C.P. as standard Slide out refrigeration system Auto defrost & Evaporation Gas: R404a Polyurethane insulation 60 mm CFC/HCFC free	304 Grade Stainless Steel Interior/Exterior Interior rounded corner Adjustable Inox feet Self closing doors Plastic-coated shelves dim. 530x650 mm On request available:	Stainless Steel shelves; Work top whit Spla-shback; Door lock; Castors; Drawer kits, Glass door on TN, Refrigerated or neutral drawer above the cooling unit
 <b>Contrôle électronique</b> Contrôle électronique H.A.C.C.P Unité hermétique extractible sur glissières Dégivrage automatique avec réévaporation des eaux Gaz: R404a Isolation épaisseur 60 mm sans CFC/	HCFC Revêtement Intérieur/extérieur en Acier Inox AISI 304 Angles arrondis intérieur Pieds réglables en Acier Inox 304 Portes avec fermeture automatique Grille Plastifiée dim. 530x650 mm	Options: Grille Inox, Serrure à clef, Porte a vitré sur table frigorifique, dossier, Bloc de tiroirs, Tiroir réfrigéré ou neutre au dessus du compartiment moteur.
 <b>Elektronische Steuerung</b> H.A.C.C.P auf Anfrage Automatische Abtauung Automatische Abtauwasserverdampfung Kühlmittel R404a Isolationsstärke 60mm ohne CFC und HCFC	Aussen / Innen Inox (Edelstahl) AISI 304 Intern abgerundete Ecken Reinigungsfreundlich Höhenverstellbare Inoxfüsse Tür selbstschliessend Plasikbeschichtete Roste GN 1/1 ABMeßung 530x325mm Zubehör auf Anfrage :	Roste InoxGN 1/1 ABMeßung 530x325mm Türschloss - Räder drehbar - Arbeitsplatte mit Aufkantung - Schubladenblöcke 1/3 – 1/2 – 2/3 - Glastüren nur Normaltemperatur - Gekühlte oder Ungekühlte Lade auf dem Aggregatfach
 <b>Control electrónico</b> H.A.C.C.P. en serie Unidad refrigerante extraíble Descongelación automática Evaporación automática Gas:R404a	Aislamiento 60mm sin empleo de CFC y HCFC Externo/Interno en acero inox AISI 304 Esquinas internas redondeadas Soportes ajustables en Inox Puertas autocerrantes Parrillas plastificadas dim. 530por650mm Accesorios bajo pedido	Parrillas inox.dim.530por650mm; Cerradura; Ruedas; Superficie con levantadora; Cajón; Puertas de vidrio sobre TN; Cajón refrigerado o neutro sobre vano motor
 <b>Elektronik kontrol</b> H.A.C.C.P. fonksiyonu standart Kayarak Çıkarılabilir refrigeration system Otomatik defrost & evaporasyon Gaz: R404a Poliüretan izolasyon 60 mm CFC/HCFC free	304 Kalite Paslanmaz Çelik İç ve Dış Gövde Yuvarlatılmış İç Köşeler Ayarlanabilir Paslanmaz Ayaklar Kendinden Kapanan Kapılar Plastik Kaplı Raflar Ölçüsü: 530x650 mm İsteğe bağlı olarak: Paslanmaz Çelik Raflar; Sırtlı Üst Tabla; Kapı Kilidi;	Tekerlekler; Çekmece takımları, Normal Dolalarda Cam Kapı, soğutma ünitesinin üzerinde soğutuculu veya nötr çekmece
 <b>Электронное управление</b> Функция H.A.C.C.P. в комплекте Выдвижная система охлаждения Автоматическое размораживание и испарение Фреон R404a Полиуретановый изолирующий слой 60мм, без CFC/HCFC	Внешняя и внутренняя отделка из нержавеющей стали AISI 304 Закругленные внутренние углы Регулируемые ножки из нержавеющей стали Самозакрывающиеся двери Решетки 530x650мм покрытые пластиком Дополнительно заказываются:	Решетки из нержавеющей стали, рабочая поверхность с панелью для защиты от брызг, замок на двери, ножки с колесиками, набор выдвижных ящиков, стеклянная дверь для TN, охлаждаемый или нейтральный выдвижной ящик над холодильным агрегатом



# Gold Pastry



## EURONORM



TGPM107-TGPB107 TGPM2-TGPB2

TGPM3-TGPB3

TGPM4-TGPB4

Modello Model Modell Modelo Model Модель	Price €	Temperature °C	Capacity Lt	Refrig. Power Watt	Voltage Volt/Hz	Abs. Power Watt	Dimensions WxDxH cm	Packing Dim. WxDxH cm	S/S Guides "L" shape N°	Ambient Temp. °C	Weight kg
TGPM107		-2° +8°	176	387	220-240/50	325	107x80x85	111x84x100	4	+43	115
TGPM2		-2° +8°	398	407	220-240/50	330	165,5x80x85	170x84x100	8	+43	150
TGPM3		-2° +8°	620	407	220-240/50	330	224x80x85	228x84x100	12	+43	180
TGPM4		-2° +8°	843	564	220-240/50	448	282,5x80x85	286,5x84x100	16	+43	210
TGPB107		-10° -25°	176	555	220-240/50	443	107x80x85	111x84x100	4	+43	120
TGPB2		-10° -25°	398	338	220-240/50	363	165,5x80x85	170x84x100	8	+43	160
TGPB3		-10° -25°	620	465	220-240/50	477	224x80x85	228x84x100	12	+43	190
TGPB4		-10° -25°	843	583	220-240/50	597	282,5x80x85	286,5x84x100	16	+43	220

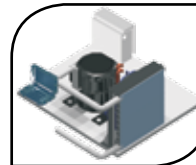

Unità refrigerante remota (non inclusa)  
Remote refrigeration system (not included)  
Unité hermetique (option)  
Kühlaggregat nicht inbegriffen  
Unidad refrigerante remota (no incluida)  
Uzakdan soğutma sistemi (dahil değil)  
Выносной холодильный агрегат  
(не входит в комплект)

Caratteristiche e prezzi a pag.46

Prices and features at pag. 46

Caractéristiques et prix voir page 46

TGPM2R-TGPB2R TGPM3R-TGPB3R

TGPM4R-TGPB4R

Modello Model Modell Modelo Model Модель	Price €	Temperature °C	Capacity Lt	Refrig. Power Watt	Voltage Volt/Hz	Abs. Power Watt	Dimensions WxDxH cm	Packing Dim. WxDxH cm	S/S Guides "L" shape N°	Ambient Temp. °C	Weight kg
TGPM2R		-2° +8°	398	-	220-240/50	-	128,5x80x85	132,5x84x100	8	+43	100
TGPM3R		-2° +8°	620	-	220-240/50	-	187x80x85	191x84x100	12	+43	130
TGPM4R		-2° +8°	843	-	220-240/50	-	245,5x80x85	249,5x84x100	16	+43	160
TGPB2R		-10° -25°	398	-	220-240/50	-	128,5x80x85	132,5x84x100	8	+43	100
TGPB3R		-10° -25°	620	-	220-240/50	-	187x80x85	191x84x100	12	+43	130
TGPB4R		-10° -25°	843	-	220-240/50	-	245,5x80x85	249,5x84x100	16	+43	160



TGPM2PT

TGPM3PT

TGPM4PT

## FRIGO PASSANTE/PASS-THRU FRIGO TRAVERSANT

Modello Model Modell Modelo Model Модель	Price €	Temperature °C	Capacity Lt	Refrig. Power Watt	Voltage Volt/Hz	Abs. Power Watt	Dimensions WxDxH cm	Packing Dim. WxDxH cm	S/S Guides "L" shape N°	Ambient Temp. °C	Weight kg
TGPM2PT		-2° +8°	398	407	220-240/50	330	165,5x85x85	170x89x100	8	+43	150
TGPM3PT		-2° +8°	620	407	220-240/50	330	224x85x85	228x89x100	12	+43	180
TGPM4PT		-2° +8°	843	564	220-240/50	448	282,5x85x85	286,5x89x100	16	+43	210





## Accessori - Accessories - Accessoires - Zubehör - Accesorios - Seçenekleri - Доп. опция

 Questi accessori possono essere ordinati esclusivamente insieme al prodotto a cui si riferiscono, e non possono essere ordinati separatamente. I prezzi degli accessori, indicati in questo listino, sono solo incrementi e non normali prezzi di vendita. Per ordini separati è necessario consultare il listino ricambi non incluso in questo catalogo.

 Those options are to be ordered only at the moment of ordering a corresponding model and it is impossible to order them separately. The price of the accessories represents only the price increasing and it isn't the accessories price list. To order other accessories, please, check a separate "Spare parts list price".



 Ces accessoires ne peuvent être commandés à ce prix qu'avec le meuble, et ne peuvent pas l'être séparément. Pour commande séparée uniquement d'accessoires, il est nécessaire de consulter le tarif pièces détachées non inclu dans ce catalogue.

 Dieses Zubehör kann nur ausschließlich in Phase der Bestellung des Produktes bestellt werden, auf die sie sich beziehen, und können nicht separat bestellt werden. Für die Bestellung von Ersatzteilen ist der Ersatzteilkatalog zu konsultieren der nicht in diesem Listenpreis beigefügt ist.

 Estos accesorios se pueden ordenar exclusivamente en fase de pedido del producto al que se refieren, y no se pueden pedir separadamente. Los precios de los accesorios, indicados en este listín, son sólo incrementos y no normales precios de venta. Por pedidos separados es necesario consultar el listín accesorios no incluido en este listín.

				
<b>600x400</b>	<b>600x400</b>	<b>600x400</b>		
Griglia Inox 600X400 Inox shelf 600X400 Grille Inox 600X400 Plastifizierter Rost 600X400 Parilla acero Inox 600X400 Paslanmaz çelik raf 600X400 решетки из нержавеющей стали 600X400	Griglia plastificata 600X400 Plastic-coated shelf 600X400 Grille plastifiée 600X400 Plastifizierter Rost 600X400 Parilla Plastificada 600X400 Plastik kapli çelik raf 600X400 Пластифицированные решетки 600X400	Teglia alluminio 600x400 Aluminum bakery-pan 600x400 Plaque en aluminium 600x400 Aluminium-Backbleche 600x400 Bandeja de aluminio 600x400 Aliminyum Bakery Tepsisi Алюминиевый противень для выпечки 600x400	Ruote piroettanti, 2 con freno Lockable castors, 2 with brakes Roulettes pivotantes, 2 avec freins Fussrollen, zwei mit Bremsen Ruedas giratorias, dos con freno Kilitli Tekerlekler, iki Frenli Ножки с колесиками, две – с тормозами	Piede inox flangiato S/S flanged foot Pied in acier avec bride Edelstahl-Flansch-Fuß Pies con bridas de acero Paslanmaz çelik flansi ayak

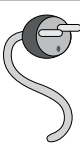
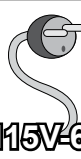
				
Ruote piroettanti, 2 con freno Lockable castors, 2 with brakes Roulettes pivotantes, 2 avec freins Fussrollen, zwei mit Bremsen Ruedas giratorias, dos con freno Kilitli Tekerlekler, iki Frenli Ножки с колесиками, две – с тормозами	Piano con alzatina Splashback Dossieret Arbeitsplatte mit Aufkantung Plano con levantadora Sirtli Üst Tabla Панель для защиты от брызг	Lavello 33x33 cm Sink 33x33 cm	Rubinetto miscelatore Mixer tap	Porta a vetro Glass door Porte Vitré Glastüren Puertas de vidrio Cam Kapı Стеклопанель дверь

			
<b>220V-60Hz</b>	<b>115V-60Hz (NO ETL-UL)</b>	<b>1/2</b>	
Alimentazione Voltage	Alimentazione Voltage	Cassettiera Drawer set Bloc de tiroirs Schubladenblöcke Cajón	Cassetto neutro su vano motore Neutral drawer above the cooling unit Tiroir neutre au dessus du compartiment moteur. Ungesühlte Lade auf dem Aggregatfach Cajón neutro sobre vano motor Motor boşluğu üzerinde sogutmalı çekmecelik Нейтральный ящик над холодильным агрегатом
		<b>1/2</b>	

# ice line

## Gelateria Glacier

H.A.C.C.P. di serie



H.A.C.C.P. as standard

Spessore da 60 mm su tutta la scocca.

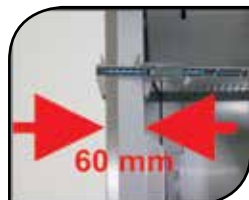

Insulation thickness 60 mm CFC & HCFC free.

Cremagliere amovibili senza l'uso di utensili



Completely removable racking for easy cleaning

Cruscotto incernierato per consentire facile accesso alle parti elettriche ed all'unità motocondensante.



Hinged control panel for service access

Esterno in acciaio inox Aisi 304. A richiesta schienale in acciaio per installazione ad isola.



304 Grade in Stainless steel exterior. Complete stainless steel back option for island siting.

Serratura di serie



Door lock as standard

Luce interna di serie



Interior light as standard

Unità refrigerante a monoblocco per sfruttare tutta la capacità di stoccaggio.



Compact Refrigeration System featuring designed to maximise available capacity.

Griglie plastificate posizionabili ogni 60 mm



Trayslide adjustable at 60mm intervals

Garnizioni removibili per una facile pulizia



Wide magnetic gasket gives effective seal and is removable for easy cleaning

Interno in acciaio Aisi 304. Angoli interni arrotondati.



Interior Stainless Steel AISI 304. Rounded corner internal for easy cleaning





Controllo Elettronico  
H.A.C.C.P. di serie su GB7  
Statico a serpentino con ventilatore a ricircolo.  
Sbrinamento manuale  
Evaporazione automatica  
Gas : R404a

Luce interna di serie su GB7  
Isolamento 60 mm privo di CFC/HCFC  
Esterno ed Interno in acciaio inox Aisi 441 o 304  
Angoli interni arrotondati  
Serratura con chiavi di serie  
Piedini regolabili in Inox su GB7  
Griglie plastificate dim. 530x650mm

Optional  
Griglie inox, Ruote piroettanti di cui due fisse con freno, controllore H.A.C.C.P.



Electronic control  
H.A.C.C.P. as standard on GB7  
Fan assisted static serpentine  
Manual defrost  
Auto evaporation  
Gas: R404a

Polyurethane insulation 60 mm  
CFC/HCFC free  
Stainless Steel Interior/Esterior  
Interior radiused corner  
Door lock as standard  
Interior Light as standard on GB7 mod.

Adjustable Inox feet  
Self closing Glass doors  
Plastic-coated shelves (530x650 mm)  
Optional  
Stainless Steel shelves , H.A.C.C.P. Control,  
Lockable swivel castors.



Contrôle électronique  
Contrôle électronique H.A.C.C.P. (GB7)  
Dégivrage manuel avec réévaporation des eaux  
Gaz: R404a

Isolation épaisseur 60 mm sans CFC/HCFC Re-  
vêtement Intérieur/extérieur  
en Acier Aisi 441 (304 sur GB7)  
Angles arrondis intérieurs  
Lumière Intérieure  
Serrure à clé

Pieds réglables en Acier Inox 304  
Portes à Fermeture automatique  
Grille Plastifiée dim. 530x650 mm  
Options  
Grille Inox, Contrôle électronique H.A.C.C.P.,  
Roulettes pivotantes.



Elektronische Steuerung mit H.A.C.C.P.  
Serienmässig (GB7)  
Manuelle Abtaug  
Automatische Abtauwasserverdunstung  
Kühlmittel R404a  
Licht Serienmässig bei Glastüren  
Isolationsstärke 60mm ohne CFC und

HCFC  
Aussen / Innen Kunststoffbeschichtets weisses  
Stahlblech – Intern abgerundete Ecken  
Türschloss Serienmässig  
Höhenverstellbare Inoxfüsse  
Glastüre mit Aluminiumrahmen  
Plastikbeschichtete Roste ABMeßungen

530x650mm  
Optionals :  
Inox (Edelstahl) Roste ABMeßungen  
530x650mm - Räder (zwei drehende und  
zwei feste) - Elektronische Steuerung mit  
H.A.C.C.P



Control electrónico  
H.A.C.C.P de serie (GB7)  
Descongelación manual  
Evaporación automática  
Gas: R404a  
Luz interna en serie  
Aislamiento 60mm sin CFC/HCFC

Externo/Interno en acero  
Esquinas internas redondeadas  
Cerradura con llaves en serie  
Soportes ajustables en inox  
Parrillas plastificadas dim. 530 por 650 mm  
Optional  
Parrillas en inox. Ruedas giratorias con dos fijas

con freno, monitor H.A.C.C.P.



Elektronik Kontrol  
H.A.C.C.P Kontrol (GB7/  
Manual Defrost  
Otomatik Evaporasyon  
Gaz: R 404 A  
Poliüretan İzolasyon 60 mm CFC/HCFC  
Free

304 Kalite Paslanmaz Dış ve İç Gövde  
Yuvarlatılmış İç Köşeler  
Kapıda Kilit Standarttır  
İç Işıklandırma Camlı Modellerde Standarttır.  
Ayarlanabilir Paslanmaz Ayaklar  
Plastik Kaplı Raflar Ölçüsü: 530x550 mm  
Paslanmaz Çelik Raflar Ölçüsü: 530x550 mm

isteğe Bağlı.  
Opsiyonel:  
Paslanmaz Çelik Raflar  
H.A.C.C.P Kontrol  
Kilitlenebilir Döner Tekerlekler



Электронное управление  
Компактная система охлаждения  
Ручное разморозка  
Автоматическое испарение  
Фреон R404a  
Полиуретановый изолирующий слой  
60мм без CFC/HCFC

Внутренняя и внешняя отделка из пластика  
Внутренние закругленные углы  
Замок на двери в комплекте  
Внутренняя подсветка на моделях со  
стеклянными дверями идет в комплекте  
Регулируемые ножки из нержавеющей стали  
Самозакрывающиеся стеклянные двери

Решетки с размерами 530x650мм покрытые  
пластиком  
Дополнительно:  
Решетки из нержавеющей стали, функция  
H.A.C.C.P., ножки с вращающимися  
колесиками





# Ice Cream



GELATERIA - GLACIER



Esterno ed Interno in acciaio Inox AISI 441 SB

Stainless Steel AISI 441 SB Exterior/ Interior

STATICOASERPENTINACONVENTILATOREARICIRCOLO.  
FANASSISTEDSTATICSERPENTINE.

MAX  
64 Vaschette\*  
64 Basket\*  
64 Bacs\*  
\*non include  
not included  
non inclus

SCB6

Modello Model Modell Modelo Model Модель											
	Price	Temperature	Capacity	Refrig. Power	Voltage	Abs. Power	Dimensions	Packing Dim.	Shelves	Ambient Temp.	Weight
		°C	Lt	Watt	Volt/Hz	Watt	WxDxH cm	WxDxH cm	N°	°C	kg
SCB6		-10° -25°	600	578	220-240/50	443	70x86x199	72x90x215	5	+43	120



Esterno ed Interno in acciaio Inox AISI 304 SB

Stainless Steel AISI 304 SB Exterior/ Interior

STATICOASERPENTINACONVENTILATOREARICIRCOLO.  
FANASSISTEDSTATICSERPENTINE.

MAX  
58 Vaschette\*  
58 Basket\*  
64 Bacs\*  
\*non include  
not included  
non inclus

GB7ICE

Modello Model Modell Modelo Model Модель											
	Price	Temperature	Capacity	Refrig. Power	Voltage	Abs. Power	Dimensions	Packing Dim.	Shelves	Ambient Temp.	Weight
		°C	Lt	Watt	Volt/Hz	Watt	WxDxH cm	WxDxH cm	N°	°C	kg
GB7ICE		-15° -28°	620	450	220-240/50	600	71x89x204	76x93x228	5	+43	155

Accessori - Accessories - Accessoires - Zubehör - Accesorios - Seçenekleri - Доп. опция

H.A.C.C.P.				
	530x650	Vaschetta 165x360x120 Basket 165x360x120 Bac 165x360x120	220V-60Hz	115V-60Hz (NO ETL-UL)
Controllo H.A.C.C.P. H.A.C.C.P. control Contrôle avec dispositif HACCP Steuerung mit H.A.C.C.P. Control electrónico H.A.C.C.P. Kontrol H.A.C.C.P. Электронное управление HACCP	Kit Griglia plastificata con guide Plastic-coated shelf with guides Grille plastifiée avec glissières Plastifizierter Rost mit Schienen Parilla Plástica con guías Plastik kapli çelik raf raylarla beraber Пластифицированные решетки с направляющими		Alimentazione Voltage	Alimentazione Voltage

# Note

A series of horizontal dashed lines for writing notes.

Spessore isolamento 100mm  
senza CFC E HCFC sulle grandi  
celle (20G e 40G)



Insulation thickness 100 mm  
CFC & HCFC free on the Blast  
Chiller Roll-in..

Controllo elettronico con  
interfaccia di facile utilizzo



User friendly menu controls

Guarnizione amovibili per una  
facile pulizia



Wide magnetic gasket gives  
effective seal and is removable for  
easy cleaning

Controllore Touch Screen con  
funzionalità avanzate con inter-  
faccia utente estremamente in-  
tuitiva. (Optional)



Touch Screen Controller with  
enhanced functionality with ex-  
tremely intuitive user interface.  
(available on request)

Sonda al cuore di serie,  
Sonda al cuore riscaldata  
su richiesta



Core Probe as standard.  
Heated Core Probe  
available on request

Carrelli GN 2/1 su richiesta

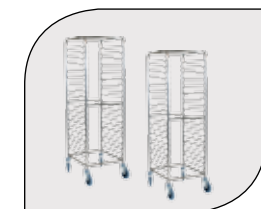

Trolley GN 1/1 - 2/1  
available on request

Spessore isolamento 60mm  
senza CFC E HCFC;

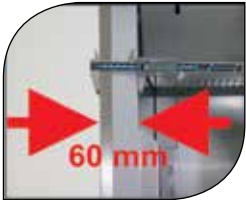

Insulation thickness 60 mm  
CFC & HCFC free.

Struttura porta teglie universale  
(GN-EN), esclusi i modelli 3 e 5  
teglie.



Universal racks structure  
(GN / EN), not available on  
the 3 and 5 trays models.

Esterno in acciaio inox  
AISI 304



Exterior in Stainless steel  
AISI 304

Due ruote piroettanti e due fisse  
con freno su richiesta, esclusi  
modelli 20G e 40G



Lockable castors available on  
request, excluded models 20G  
and 40G (Roll-in blast chiller)

Interno in acciaio Inox AISI 304.  
Angoli interni arrotondati per  
una facile pulizia.



Interior Stainless Steel AISI 304.  
Rounded corner internal  
for easy cleaning

Sterilizzatore integrato  
a richiesta



Sterilizer available on request





## ABBATTITORIRAPIDIDITEMPERATURA-CELLULESDEREFROIDISSEMENT-SCHNELLÜHLER-ABATIDORESRÁPIDOSDETEMPERATURA



Controllo Elettronico  
H.A.C.C.P di serie  
Sbrinamento automatico a gas  
caldo escluso modelli con gruppo  
remoto (Roll-in)  
Gas eco-compatibile: R404a

Isolamento 60 mm privo di CFC/HCFC  
Isolamento 100 mm privo di CFC/HCFC  
sulle grandi celle 20G / 40G (Roll-in)  
Risparmio Energetico del 20%  
Esterno/Interno in acciaio inox AISI 304  
compreso schienale esterno  
Porte reversibili e autochiudenti

La camera ha angoli interni arrotondati per una  
agevole e rapida pulizia  
Piedini regolabili in Inox  
*Optional*  
Sonda al cuore riscaldata, Sterilizzatore removibi-  
le, Ripiani, Carrelli , Ruote piroettanti di cui 2 fisse  
con freno.



Electronic control  
H.A.C.C.P. as standard  
Hot gas automatic defrost, exclu-  
ded models 20G / 40G  
(Roll-in blast chiller)  
Gas: R404a

Insulation Thickness 60 mm CFC/HCFC free  
Insulation Thickness 100 mm CFC/HCFC free  
on the Roll-in blast chiller (20G / 40G)  
20% saving on energy consumption  
304 Grade Stainless Steel Interior/Exterior  
Interior rounded corner  
Easy-Clean Coved Interior

Stainless Steel back as standard  
Adjustable Inox feet  
Reversible & Self closing doors  
Push-Fit Magnetic Door Seals  
*Optional*  
Racks, Trays, Roll-ins, Lockable castors, Remova-  
ble Sterilizer, Heated Core Probe.



Contrôle électronique  
Contrôle électronique H.A.C.C.P  
Cycle de dégivrage automatique par  
gaz chaud sauf sur modèles 20G  
/ 40G  
Gaz: R404a

Isolation épaisseur 60 mm sans CFC/HCFC  
Isolation épaisseur 100 mm sans CFC/HCFC  
pour modèles 20G / 40G (Chariot)  
Revêtement Intérieur/extérieur en Acier Inox  
AISI 304 (tôle arrière extérieure compris)  
Angles arrondis intérieurs

Pieds réglables en Acier Inox  
Portes réversibles et Fermeture automatique  
*Option*  
Grilles, Chariot , Deux roues pivotantes et deux  
fixes avec freins, Stérilisant amovible, Sonde à  
piquer à coeur produit.



Elektronische Steuerung  
H.A.C.C.P Serienmässig  
Automatische Abtaung (Heissgas)  
ausgenommen bei modellen die  
für Fernanschluss vorgesehen sind  
(Roll-in) - Kühlmittel R404a  
Isolationsstärke 60mm ohne CFC

und HCFC  
Isolationsstärke 100mm ohne CFC und HCFC  
bei den grossen Zellen 20G und 40G (Roll-in)  
Energieeinsparung bis zu 20%  
Aussen / Innen Inox (Edelstahl) AISI 304 - Inklusiv  
Rückwand und Boden aussen  
Türanschlag wechselbar und selbstschliessend

Intern abgerundete Ecken Reinigungsfreundlich  
Höhenverstellbare Inoxfüsse  
Geheizter Nadelfühler - Mobiler Sterilisator - Ble-  
che - Rollwagen - Räder (zwei drehende und zwei  
feste)



Control Electrónico  
H.A.C.C.P en serie  
Descongelación automática de gas  
caliente excluidos los modelos con  
grupo remoto(Roll-in)  
Gas eco - compatible: R404a  
Aislamiento 60mm sin CFC/HCFC

Aislamiento 100mm sin CFC/HCFC  
Sobre las grandes cámaras 20G/40G(Roll-in)  
Ahorro energético del 20%  
Externo/Interno en acero inox AISI 304 incluido  
respaldo externo  
Puertas reversibles y autocerrantes  
La cámara tiene esquinas internas redondeadas

para facilitar una rápida limpieza  
Soportes ajustables en Acero  
*Optional*  
Sensor de aguja calentado, Esterilizador remo-  
vible, Estantes, Carros, Ruedas giratorias con  
dos fijas con freno



Elektronik Kontrol  
H.A.C.C.P Standarttır.  
Sıcak Gazlı Otomatik Defrost. 20G /  
40G (Roll-in Blast Chiller) modellerin-  
de bu özellik yoktur.  
Gaz: R404 A  
İzolasyon Kalınlığı 60 mm CFC/HCFC  
Free

Roll-in Blast Chiller'da (20G / 40 G) İzolasyon  
Kalınlığı 100 mm CFC/HCFC free  
304 Kalite Paslanmaz Çelik İç ve Dış Gövde  
Yuvarlatılmış İç Köşeler  
Kolay Temizlenebilir İç Gövde  
Arka Yüz Paslanmaz Çelik  
Ayarlanabilir Paslanmaz Ayaklar  
Yön Değiştirilebilir & Kendinden Kapanan Kapılar

*Opsiyonel:*  
İç Dikmeler, Tepsiler, Roll-In Arabaları, Kilitli Teker-  
lekler, Çıkartılabilir Sterilizer, Isıtılmış Çekirdek Probu



Электронное управление  
Функция H.A.C.C.P. в комплекте  
Автоматическое размораживание  
теплым газом за исключением  
моделей 20G / 40G (Roll-in blast  
chiller)  
Фреон R404a  
Толщина изолирующего слоя 60мм

без CFC/HCFC  
Толщина изолирующего слоя 100мм, без CFC/  
HCFC, на моделях на 20G и 40G  
20%- ая экономия электроэнергии  
Внутренняя и внешняя отделка из  
нержавеющей стали 304  
Внутренние закругленные углы  
Внутренняя камера легко моется

Задняя панель из нержавеющей стали в комплек-  
те  
Регулируемые ножки из нержавеющей стали  
Перевешиваемые и самозакрывающиеся двери  
Съемные магнитные прокладки дверей  
Дополнительно  
Кассеты для контейнеров, Контейнеры,  
Тележки, Ножки с колесиками, Съемный  
стерилизатор, Температурный датчик-щуп



Modello Model Modell Modelo Model Модель	Price €	Temperature °C	Not included Racks GN 1/1	Not included Trays 600x400	60 mm Distance between racks mm	90 min Output Chilling +90° / +3°	270 min Output Freezing +90° / -18°	Voltage Volt/Hz	Abs. Power Watt	Dimensions WxDxHcm	Packing Dimens. WxDxH cm	°C	Weight Kg
---	------------	-------------------	---------------------------------	----------------------------------	---------------------------------------	---	---	--------------------	--------------------	-----------------------	-----------------------------	----	--------------

Abbattitori Rapidi di Temp. - Blast Chillers			Not included		Kg	Kg						
GBC-5G	+90°/+3°	5		60	14		220/50/1	639	80x70x85	84x74x100	38	120
GBC-7	+90°/+3°	7	7	60	18		220/50/1	933	80x83x111	84x87x127	38	140
GBC-15	+90°/+3°	15	15	68	40		380/50/3	2980	80x83x200	84x87x215	38	250
GBC-18	+90°/+3°	18	18	67	51		380/50/3	3321	80x83x217	84x87x230	38	270

Abbattitori/Surgelatori Rapidi di Temperatura - Blast Chillers & Shock Freezers												
	°C	GN 2/3	600x400	mm	+90° / +3°	+90° / -18°	Volt/Hz	Watt	WxDxHcm	WxDxH cm	°C	Kg
GBF-3GN23	+90°/-18°	3		70	7	5	220/50/1	650	60x60x40	64x44x55	32	50
	°C	GN 1/1	600x400	mm	+90° / +3°	+90° / -18°	Volt/Hz	Watt	WxDxHcm	WxDxH cm	°C	Kg
GBF-5P	+90°/-18°	5	5	60	14	8	220/50/1	721	80x80x85	84x84x100	38	100
GBF-5G	+90°/-18°	5		60	14	8	220/50/1	721	80x70x85	84x74x100	38	100
GBF-7	+90°/-18°	7	7	60	18	11	220/50/1	1169	80x83x111	84x87x127	38	110
GBF-10	+90°/-18°	10	10	60	30	20	380/50/3	1900	80x83x196	84x87x211	38	130
GBF-12GN2/1	+90°/-18°	12GN2/1		68	60	40	380/50/3	2200	81x110x185	84x114x200	38	180
GBF-15	+90°/-18°	15	15	68	40	30	380/50/3	2103	80x83x200	84x87x215	38	225
GBF-18	+90°/-18°	18	18	67	51	35	380/50/3	2103	80x83x217	84x87x230	38	250

\* Le rese sono puramente indicative e dipendono dalla massa dell'alimento - The declared output Kg is merely indicative and depends from the product thickness - Les rendements sont purement indicatifs selon l'épaisseur du produit - Die Werte in Kg sind rein indikativ sie sind abhängig von der Maße der Nahrung. - Las rendiciones son indicativas y dependen de la masa del alimento -



## ENHANCED VERSION



Modello Model Modell Modelo Model Модель	Price €	Temperature °C	Not included Racks	Not included Trays	60 mm Distance between racks mm	90 min Output Chilling Kg	270 min Output Freezing Kg	Voltage Volt/Hz	Abs. Power Watt	Dimensions WxDxHcm	Packing Dimens. WxDxH cm	°C	Weight Kg
---	------------	-------------------	-----------------------	-----------------------	---------------------------------------	---------------------------------	----------------------------------	--------------------	--------------------	-----------------------	-----------------------------	----	--------------

Abbattitori/Surgelatori Rapidi di Temperatura - Blast Chillers & Shock Freezers												
	°C	GN 1/1	600x400	mm	+90° / +3°	+90° / -18°	Volt/Hz	Watt	WxDxHcm	WxDxH cm	°C	Kg
GBF-5P+	+90°/-18°	5	5	60	20 Kg	12 Kg	220/50/1	1380	80x80x85	84x84x100	+38	135
GBF-5G+	+90°/-18°	5		60	20 Kg	12 Kg	220/50/1	1180	80x70x85	84x74x100	+38	125
GBF-7+	+90°/-18°	7	7	60	24 Kg	17 Kg	220/50/1	1863	80x83x111	84x87x127	+38	140
GBF-10+	+90°/-18°	10	10	60	35 Kg	25 Kg	380/50/3	2100	80x83x196	84x87x211	+38	180
GBF-12GN2/1+	+90°/-18°	12GN2/1		68	65 Kg	50 Kg	380/50/3	3550	81x110x185	84x114x200	+38	210
GBF-15+	+90°/-18°	15	15	68	65 Kg	50 Kg	380/50/3	3550	80x83x200	84x87x215	+38	250
GBF-18+	+90°/-18°	18	18	67	78 Kg	60 Kg	380/50/3	3550	80x83x217	84x87x230	+38	270

\* Le rese sono puramente indicative e dipendono dalla massa dell'alimento - The declared output Kg is merely indicative and depends from the product thickness - Les rendements sont purement indicatifs selon l'épaisseur du produit - Die Werte in Kg sind rein indikativ sie sind abhängig von der Maße der Nahrung. - Las rendiciones son indicativas y dependen de la masa del alimento -

GRUPPO REFRIGERANTE REMOTO INCLUSO (5M MAX)  
SPLIT SYSTEM (INCLUDED MAX 5M)



GBF-20GN1/1CV  
GBF-20GN1/1RT

GBF-23GN1/1

GBF-20GN1/1T

Modello Model Modell Modelo Model Модель												
	Price	Temperature	Racks	Racks / Roll-in	Distance between racks	90 min	270 min	Voltage	Abs. Power	Dimensions	Packing Dim.	Ambient Temp.

Abbattitori e Surgelatori rapidi di temperatura con motore remoto incluso - Blast chiller & shock freezer split system (included)

Shock Freezers	°C	GN / EN	Type	mm	+90°/+3°	+90°/-18°	Volt/Hz	Watt	LxPxH cm	LxPxH cm	°C
GBF-23GN1/1R	+90°/-18°	23 Racks GN1/1	23 Trays 60X40	68	80 Kg	65 Kg	380/50/3	3920	90x119x230	95x125x248 +68x100x70	38

Abbattitori e Surgelatori rapidi di temperatura per carrelli con motore remoto incluso- Roll-in Blast chiller & shock freezer split system (included)

Shock Freezers	°C	GN Trolley	EN60x40 Trolley	mm	+90°/+3°	+90°/-18°	Volt/Hz	Watt	LxPxH cm	LxPxH cm	°C
GBF-20GN1/1T	+90°/-18°	1x GN1/1 x 20	1xENx20		80 Kg	65 Kg	380/50/3	3920	90x119x219	95x125x238+ 68x100x70	38
GBF-20GN1/1CV	+90°/-18°	1x Convothem Oven 20.10			80 Kg	65 Kg	380/50/3	3920	105x103x228	110x108x248 68x100x70	38
GBF-20GN1/1RT	+90°/-18°	1x 20 GN 1/1 Rational Oven			80 Kg	65 Kg	380/50/3	3920	105x103x228	110x108x248 68x100x70	38

GRUPPO REFRIGERANTE REMOTO INCLUSO (5M MAX)  
SPLIT SYSTEM (INCLUDED MAX 5M)

**ENHANCED VERSION**



GBF-20GN1/1CV+  
GBF-20GN1/1RT+

GBF-23GN1/1+

GBF-20GN1/1T+

Modello Model Modell Modelo Model Модель												
	Price	Temperature	Racks	Racks / Roll-in	Distance between racks	90 min	270 min	Voltage	Abs. Power	Dimensions	Packing Dim.	Ambient Temp.

Abbattitori e Surgelatori rapidi di temperatura potenziati con motore remoto incluso - Enhanced Blast chiller & shock freezer split system (included)

Shock Freezers	°C	GN / EN	Type	mm	+90°/+3°	+90°/-18°	Volt/Hz	Watt	LxPxH cm	LxPxH cm	°C
GBF-23GN1/1R+	+90°/-18°	23 Racks GN1/1	23 Trays 60X40	68	110 Kg	95 Kg	380/50/3	4700	90x119x230	95x125x248 +68x100x70	38

Abbattitori e Surgelatori rapidi di temperatura potenziati per carrelli con motore remoto incluso- Enhanced Roll-in Blast chiller & shock freezer split system (included)

Shock Freezers	°C	GN Trolley	EN60x40 Trolley	mm	+90°/+3°	+90°/-18°	Volt/Hz	Watt	LxPxH cm	LxPxH cm	°C
GBF-20GN1/1T+	+90°/-18°	1x GN1/1 x 20	1xENx20		110 Kg	95 Kg	380/50/3	4700	90x119x219	95x125x238+ 68x100x70	38
GBF-20GN1/1CV+	+90°/-18°	1x Convothem Oven 20.10			110 Kg	95 Kg	380/50/3	4700	105x103x228	110x108x248 68x100x70	38
GBF-20GN1/1RT+	+90°/-18°	1x 20 GN 1/1 Rational Oven			110 Kg	95 Kg	380/50/3	4700	105x103x228	110x108x248 68x100x70	38

# Blast Chillers & Shock Freezers



GRUPPO REFRIGERANTE REMOTO INCLUSO (5M MAX)  
SPLIT SYSTEM (INCLUDED MAX 5M)

VERSIONE CON IMPIANTO INTEGRATO  
REFRIGERATION SYSTEM ON BOARD



Modello Model Modell Modelo Model Модель	Price	Temperature	Trolley GN	Trolley EN	Tra EN	90 min Output Chilling	270 min Output Freezing	Voltage	Abs. Power	Dimensions	Packing Dimens.	Ambient	Weight
	€	°C	GN2/1	EN 60x40	EN 60x80	+90°+3°	+90°-18°	Volt/Hz	Watt	WxDxH cm	WxDxH cm	°C	Kg

Not Included

**MOTORE REMOTO INCLUSO - BLAST CHILLER & SHOCK FREEZER SPLIT SYSTEM (INCLUDED)**

GBC-20GN2/1	+90°+3°	1 x20	2 x20	1 x20	150	380/50/3	3110	150x134x213	164x147x247 + 96x106x88	38
GBC-40GN2/1	+90°+3°	2 x20	4 x20	2 x20	270	380/50/3	5485	150x194x213	164x207x247 + 96x106x88	38
GBF-20GN2/1	+90°-18°	1 x20	2 x20	1 x20	150	380/50/3	3110	150x134x213	164x147x247 + 96x106x88	38
GBF-40GN2/1	+90°-18°	2 x20	4 x20	2 x20	280	380/50/3	6010	150x194x213	164x207x247 + 96x106x88	38

**ENHANCED VERSION**

GBF-20GN2/1+	+90°-18°	1 x20	2 x20	1 x20	200	380/50/3	7800	150x134x213	164x147x247 + 96x106x88	38
GBF-40GN2/1+	+90°-18°	2 x20	4 x20	2 x20	380	380/50/3	13800	150x194x213	164x207x247 + 96x106x88	38

**VERSIONE CON IMPIANTO INTEGRATO - GN 2/1 - VERSION WITH REFRIGERATION SYSTEM ON BOARD - GN 2/1**

GBF-20GN2/1T-UT	+90°-18°	1 x20	2 x20	1 x20				92x180x236		38
GBF-20GN2/1T-UT+	+90°-18°	1 x20	2 x20	1 x20				92x180x236		38

VERSIONE CON IMPIANTO DI MANTENIMENTO - GN 1/1  
STORAGE SYSTEM ON BOARD - GN 1/1

VERSIONE CON IMPIANTO INTEGRATO - GN 1/1  
REFRIGERATION SYSTEM ON BOARD - GN 1/1



GBF-20GN1/1MT



GBF-20GN1/1T-UT GBF-20GN1/1T-UT+

Modello Model Modell Modelo Model Модель	Price	Temperature	Trolley GN	Trolley EN	Tra EN	90 min Output Chilling	270 min Output Freezing	Voltage	Abs. Power	Dimensions	Packing Dimens.	Ambient	Weight
	€	°C	GN1/1	EN 60x40	EN 60x80	+90°+3°	+90°-18°	Volt/Hz	Watt	WxDxH cm	WxDxH cm	°C	Kg

Not Included

**VERSIONE CON IMPIANTO DI MANTENIMENTO - GN 1/1 - VERSION WITH STORAGE SYSTEM ON BOARD - GN 1/1**

GBF-20GN1/1MT	+90°-18°	1 x20	1 x20	-				126x106x228		38
---------------	----------	-------	-------	---	--	--	--	-------------	--	----

**VERSIONE CON IMPIANTO INTEGRATO - GN 1/1 - VERSION WITH REFRIGERATION SYSTEM ON BOARD - GN 1/1**

GBF-20GN1/1T-UT	+90°-18°	1 x20	1 x20	-				92x141x236		38
GBF-20GN1/1T-UT+	+90°-18°	1 x20	1 x20	-				92x141x236		38

## Accessori - Accessoires - Accessoires - Zubehör Accesorios - Seçenekleri - Доп. опция

 Questi accessori possono essere ordinati esclusivamente insieme al prodotto a cui si riferiscono, e non possono essere ordinati separatamente. I prezzi degli accessori, indicati in questo listino, sono solo incrementi e non normali prezzi di vendita. Per ordini separati è necessario consultare il listino ricambi non incluso in questo catalogo.

 Those options are to be ordered only at the moment of ordering a corresponding model and it is impossible to order them separately. The price of the accessories represents only the price increasing and it isn't the accessories price list. To order other accessories, please, check a separate "Spare parts list price".

 Ces accessoires ne peuvent être commandés à ce prix qu'avec le meuble, et ne peuvent pas l'être séparément. Pour commande séparée uniquement d'accessoires, il est nécessaire de consulter le tarif pièces détachées non inclu dans ce catalogue.

 Dieses Zubehör kann nur ausschließlich in Phase der Bestellung des Produktes bestellt werden, auf die sie sich beziehen, und können nicht separat bestellt werden. Für die Bestellung von Ersatzteilen ist der Ersatzteilkatalog zu konsultieren der nicht in diesem Listenpreis beigefügt ist.

 Estos accesorios se pueden ordenar exclusivamente en fase de pedido del producto al que se refieren, y no se pueden pedir separadamente. Los precios de los accesorios, indicados en este listín, son sólo incrementos y no normales precios de venta. Por pedidos separados es necesario consultar el listín accesorios no incluido en este listín.

 Buu katalogda gösterilen aksesuar fiyatları sadece katalog fiyatlarıdır, normal satış fiyatları değildir. Ayrı siparişler için, bu kataloga dahil olmayan Yedek Parça Fiyat Listesi kullanılmalıdır.

 Эти аксессуары должны быть заказаны вместе с основными моделями и не могут поставляться отдельно. В случае заказа этих опций к цене основной модели надо будет добавить цену опции. Для заказа остальных аксессуаров и запасных частей, пожалуйста, смотрите отдельный прайс-лист «аксессуары».

 <p><b>530x325 600x400</b></p>			<p><b>CypenVac Technology</b> Revolutionary technology for thermal insulation, which allows an energy saving of <b>-38% in storage -43% in Freezing</b></p>	 <p><b>600x400</b></p>
<p>Griglia Inox con Guide inox Stainless Steel shelf with guides Grille acier inox avec glissières Inox Rost mit Schienen Parilla acero inox con guías Paslanmaz çelik raf raylarla beraber Решетки из нержавеющей стали с направляющими</p>	<p>Ruote piroettanti, 2 con freno Lockable castors, 2 with brakes Roulettes pivotantes, 2 avec freins Fussrollen, zwei mit Bremsen Ruedas giratorias, dos con freno Kilitli Tekerklekler, iki Frenli Ножки с колесиками, две – с тормозами</p>	<p>Sonda al cuore riscaldata Heated Core Probe Sonde à cœur chauffante Geheizter Nadelfühler Sensor de aguja calentado Isıtılmış Çekirdek Probu Датчик-щуп с нагревом</p>	<p>CypenVac Technology - Aumenta notevolmente l'efficacia dell'isolamento termico, portando un risparmio energetico del 38% in conservazione e del 43% in congelamento. CypenVac Technology - increases the effectiveness of the thermal insulation of 100%.</p>	<p>Teglia alluminio 600x400 Aluminum bakery-pan 600x400 Plaque en aluminium 600x400 Aluminium-Backbleche 600x400 Bandeja de aluminio 600x400 Aliminyum Bakery Tepsisi Алюминиевый противень для выпечки 600x400</p>
<p>GBF-5/7/10/12/15/18</p>	<p>GBF-5/7/10/12/15/18</p>			
 <p><b>GBF 5/7</b></p>	 <p><b>GBF 10/12/15/18</b></p>	 <p><b>GBF 20 GBF 40</b></p>	 <p><b>220V-60Hz</b></p>	 <p><b>115V-60Hz (NO ETL-UL)</b></p>
<p>Sterilizzatore integrato Nr.1 Embended Sterilizer Nr.1 Stérilisant Nr.1 Sterilisator Nr.1 Esterilizador Nr.1 Sterilizer Nr.1 Стерилизатор Nr.1</p>	<p>Sterilizzatore integrato Nr.2 Embended Sterilizer Nr.2 Stérilisant Nr.2 Sterilisator Nr.2 Esterilizador Nr.2 Sterilizer Nr.2 Стерилизатор Nr.2</p>	<p>Sterilizzatore integrato Embended Sterilizer Stérilisant Sterilisator Esterilizador Sterilizer Стерилизатор</p>	<p>Alimentazione Voltage</p>	<p>Alimentazione Voltage</p>
<p>GBF 5/7</p>	<p>GBF 10/12/15/18</p>	<p>GBF 20 (NR. 4) GBF 40 (NR. 8)</p>		
			 <p><b>until 10 m 15 m</b></p>	 <p><b>GN 1/1 GN 2/1</b></p>
<p>Controllore Touch Screen con funzionalità avanzate. Haccp di serie. Porta USB Touch Screen Controller with enhanced functionality. Haccp as standard. USB port</p>	<p>Router wi fi per ctrl touch screen Router wi fi for touch screen panel</p>	<p>Stampante haccp Haccp Printer imprimante Haccp impresora Haccp</p>	<p>incremento per unità remota fino a: increase price for remote unit until: Augmenter le prix de l'unité à distance jusqu'à Incremento del precio de la unidad remota hasta</p>	<p>Carrello GN 1/1-2/1 per 20G Trolley GN 1/1-2/1 for 20G Chariot GN 1/1-2/1 pour 20G Rollwagen GN 1/1-2/1 für 20G Carros GN 1/1-2/1 por 20G Roll-In Arabaları Тележка GN 1/1-2/1 на 20 G</p>





PREP STATION

SALADETTES

PIZZA PREP TABLES

PAN COOLERS



**FOOD PREPARATION TABLES - SALADETTES - PIZZAPREPTABLES - PAN COOLERS - MESAREFRIGERADA PARA ENSALADA Y PIZZA**

	<p>Controllo Elettronico            Ventilato            H.A.C.C.P su richiesta            Sbrinamento automatico            Evaporazione automatica            Gas : R404a            Isolam. da 50 mm senza CFC/HCFC            Esterno/Interno in acciaio inox AISI</p>	<p>304/441            Angoli interni arrotondati            Piedini regolabili            Griglie plastificate GN 1/1 (530x325mm) per porta  <i>Accessori a richiesta:</i>            Controllore H.A.C.C.P</p>	<p>Ruote piroettanti (solo su TSM)            Piedini regolabili Inox (escluse saladettes)            Griglie inox dim. 530x325mm            Porte a vetro (solo su TSM)            Bacinelle Gastronorm</p>
	<p>Electronic control            Ventilated            H.A.C.C.P. function available            Auto defrost &amp; evaporation            Gas: R404a            Polyurethane insulation 50mm CFC &amp; HCFC free</p>	<p>304/441 Grade Stainless Steel Interior/Exterior            Interior rounded corner            Adjustable feet            Plastic-coated shelves dim. 530x325 mm for door  <i>Accessories on request</i>            Lockable castors, 2 with brakes (TSM model)</p>	<p>Adjustable Inox feet (TSM model)            Stainless Steel shelves GN 1/1            Glass door (TSM model)            Gastronorm Pans</p>
	<p>Contrôle électronique            Froid ventilé            Options dispositif digitale H.A.C.C.P            Dégivrage automatique avec réévaporation des eaux            Gaz: R404a            Isolation ép. 50 mm sans CFC/HCFC</p>	<p>Revêtement Intérieur/extérieur en Acier Inox AISI 304/441            Angles arrondis intérieurs            Pieds réglables            Grille Plastifiée dim. 530x650 mm pour porte            En options:            Roulettes pivotantes, 2 avec freins</p>	<p>Pieds réglables en Acier Inox 304            Grille Inox dim. 530x650 mm            Porte vitrée sur mod. TSM            Bacs Gastronorm</p>
	<p>Elektronische Steuerung            Umluft            H.A.C.C.P auf Anfrage            Automatische Abtauuung            Automatische Abtauwasserverdampfung            Kühlmittel R404a            Isolationsstärke 50mm ohne CFC und HCFC</p>	<p>Aussen / Innen Inox Edelstahl AISI 304/441            Abgerundete Ecken            Höhenverstellbare Plastikfüsse            Plastikbeschichtete Roste GN 1/1 ABMeßung 530x325mm            Zubehör auf Anfrage :            H.A.C.C.P auf Anfrage</p>	<p>Räder drehbar (nur Modelle TSM)            Höhenverstellbare Inox Füße (ausgenommen Saladetten)            Roste Inox GN 1/1 ABMeßung 530x325mm            Glastüre (nur auf Modell TSM)            Gastronorm Behälter</p>
	<p>Control electrónico ventilado            H.A.C.C.P. bajo pedido            Descongelación automática            Evaporación automática            Gas:R404a            Aislamiento desde 50mm sin empleo de CFC y HCFC            Externo/Interno en acero inox AISI</p>	<p>304/441            Esquinas internas redondeadas            Soportes ajustables            Parrillas plastificadas GN1/1(530x325mm) por puerta            Accesorios bajo pedido            Revisor H.A.C.C.P.</p>	<p>Ruedas giratorias(sólo sobre TSM)            Soportes ajustables en Inox (excluidas las mesas refrigeradas para ensalada)            Parrillas inox. dim. 530x325mm            Puertas de vidrio(sólo sobre TSM)            Barreñas Gastronorm</p>
	<p>Elektronik kontrol            Fanlı soğutma            H.A.C.C.P. fonksiyonu mevcut            Otomatik defrost &amp; evaporasyon            Gaz: R404a            Poliüretan izolasyon 50 mm CFC &amp; HCFC free            304/441 Kalite Paslanmaz Çelik İç ve Dış</p>	<p>Gövde            Yuvarlatılmış İç Köşeler            Ayarlanabilir Ayaklar            Plastik Kaplı Raflar Ölçüsü: 530x325 mm            Kapı için            İsteğe bağlı aksesuarlar:            Kilitlenebilir tekerlekler, 2 frenli (TSM model)</p>	<p>Ayarlanabilir Paslanmaz Ayaklar (TSM model)            Paslanmaz Çelik Raflar GN 1/1            Cam Kapı (TSM model)            Gastronorm Kaplar</p>
	<p>Электронное управление            Вентилируемый            Доступна функция H.A.C.C.P.            Автоматическое размораживание и испарение            фреон R404a            Полиуретановый изолирующий слой</p>	<p>50мм, без CFC &amp; HCFC            Внутренняя и внешняя отделка из нержавеющей стали AISI 304/441            Закругленные внутренние углы            Регулируемые ножки            Решетки для двери 530x325мм покрытые пластиком</p>	<p>Аксессуары под заказ:            Ножки с вращающимися колесиками, две – с тормозами (для модели TSM)            Регулируемые ножки из нержавеющей стали (для модели TSM)            Решетки GN 1/1 из нержавеющей стали            Стеклопанель (для модели TSM)            GN контейнеры</p>

## PREP TABLES GASTRONORM GN 1/1



GN Pans not included  
Bacinelle non incluse



TSM2PT



TSM3PT



TSM4PT

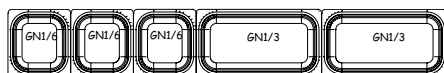
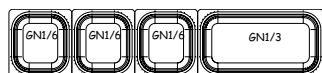

Modello Model Modell Modelo Model Модель	Price	Temperature	Capacity	Refrig. Power	Voltage	Abs. Power	Dimensions	Packing Dim.	GN Pans	Ambient Temp.	Weight
	€	°C	Lt	Watt	Volt/Hz	Watt	WxDxH cm	WxDxH cm	Not included	°C	kg
TSM2PT		0° +8°	275	308	220-240/50	331	131x70x100	143x81x123	5	+43	130
TSM3PT		0° +8°	428	407	220-240/50	348	177,5x70x100	190x81x123	7	+43	170
TSM4PT		0° +8°	581	564	220-240/50	448	224x70x100	143x81x123	10	+43	200



TSS1S



TSS2S



TSS2G

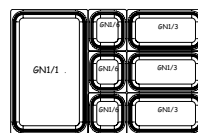

GN Pans not included  
Bacinelle non incluse



Statico con agitatore d'aria  
Static with fan  
Statique avec agitateur d'air  
Statisch mit Lüfter

Modello Model Modell Modelo Model Модель	Price	Temperature	Capacity	Refrig. Power	Voltage	Abs. Power	Dimensions	Packing Dim.	Shelves	Ambient Temp.	Weight
	€	°C	Lt	Watt	Volt/Hz	Watt	WxDxH cm	WxDxH cm	N°	°C	kg
TSS1S		0° +10°	115	387	220-240/50	322	46,5x70x91	60x86x101	1	32	50
TSS2S		0° +10°	260	387	220-240/50	325	93x70x91	106x86x101	2	32	90
TSS2G		0° +10°	260	387	220-240/50	325	93x70x91	106x86x101	2	32	90



TSS2PT



TSS3PT



TSS3S



TSS3G



GN Pans not included  
Bacinelle non incluse



Statico con agitatore d'aria  
Static with fan  
Statique avec agitateur d'air  
Statisch mit Lüfter

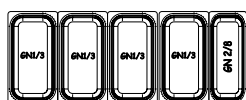

Modello Model Modell Modelo Model Модель	Price	Temperature	Capacity	Refrig. Power	Voltage	Abs. Power	Dimensions	Packing Dim.	Shelves	Ambient Temp.	Weight
	€	°C	Lt	Watt	Volt/Hz	Watt	WxDxH cm	WxDxH cm	N°	°C	kg
TSS3S		0° +10°	405	555	220-240/50	440	139,5x70x91	153x86x101	3	32	130
TSS3G		0° +10°	405	555	220-240/50	440	139,5x70x135	153x86x133	3	32	140
TSS2PT		0° +10°	260	387	220-240/50	325	93x70x108	106x86x127	2	32	95
TSS3PT		0° +10°	405	555	220-240/50	440	139,5x70x108	153x86x127	3	32	140

## PREP TABLES GASTRONORM GN 1/1



Statico con agitatore d'aria  
Static with fan  
Statique avec agitateur d'air  
Statisch mit Lüfter



TSS2PI

TSS2PIC2

TSS2PIC4

TSS3PI

TSS3PIC4

TSS3PIC6

Modello Model Modell Modelo Model Модель	Price	Temperature	Capacity	Refrig. Power	Voltage	Abs. Power	Dimensions	Packing Dim.	Shelves	Ambient Temp.	Weight
	€	°C	Lt	Watt	Volt/Hz	Watt	WxDxH cm	WxDxH cm	N°	°C	kg
TSS2PI		0° +10°	260	387	220-240/50	325	93x70x91	106x86x101	2	32	90
TSS2PIC2		0° +10°	260	387	220-240/50	325	93x70x91	106x86x101	2	32	90
TSS2PIC4		0° +10°	260	387	220-240/50	325	93x70x91	106x86x101	2	32	90
TSS3PI		0° +10°	428	550	220-240/50	440	140X70X91	150x86x101	3	32	130
TSS3PIC2		0° +10°	428	550	220-240/50	440	140X70X91	150x86x101	2+2CA	32	135
TSS3PIC4		0° +10°	428	550	220-240/50	440	140X70X91	150x86x101	1+4CA	32	140
TSS3PIC6		0° +10°	428	550	220-240/50	440	140X70X91	150x86x101	6CA	32	145

## SALADETTES - PIZZA GASTRONORM GN 1/1



TS2PZ-S

TS2PZG-S

TS3PZ-S

TS3PZG-S

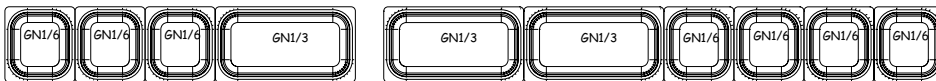

- Piano in granito
- Granite top
- Dessus en granit
- рабочая поверхность из гранита



Statico con agitatore d'aria  
Static with fan  
Statique avec agitateur d'air  
Statisch mit Lüfter

Modello Model Modell Modelo Model Модель	Price	Temperature	Capacity	Refrig. Power	Voltage	Abs. Power	Dimensions	Packing Dim.	Shelves	Ambient Temp.	Weight
	€	°C	Lt	Watt	Volt/Hz	Watt	WxDxH cm	WxDxH cm	N°	°C	kg
TS2PZ-S		0° +10°	260	387	220-240/50	325	93x70x116	106x86x134	2	32	130
TS2PZG-S		0° +10°	260	387	220-240/50	325	93x70x116	106x86x113	2	32	140
TS3PZ-S		0° +10°	405	555	220-240/50	440	139,5x70x116	153x86x134	3	32	160
TS3PZG-S		0° +10°	405	555	220-240/50	440	139,5x70x116	153x86x113	3	32	170

### Accessori - Accessories - Accessoires - Zubehör - Accesorios - Seçenekleri - Доп. опция

H.A.C.C.P.				
<p>Controllo H. A.C.C.P. H.A.C.C.P. Electronic control Contrôle électronique H.A.C.C.P. Elektronische Steuerung H.A.C.C.P. Control electrónico H.A.C.C.P. Elektronik kontrol H.A.C.C.P. Электронное управление Функция H.A.C.C.P.</p>	<p>Ruote piroettanti, 2 con freno Lockable castors, 2 with brakes Roulettes pivotantes, 2 avec freins Fussrollen, zwei mit Bremsen Ruedas giratorias, dos con freno Döner Tekerlek, 2 frenli Tekerlekler Ножки с колесиками, две – с тормозами</p>	<p>Griglia Inox con Guide inox Stainless Steel shelf with guides Grille acier inox avec glissières Inox Rost mit Schienen Parilla acero Inox con guías Paslanmaz çelik raf raylarla beraber Решетки из нержавеющей стали с направляющими</p>	<p>Kit Griglia plastificata con guide Plastic-coated shelf with guide Grille plastifiée Plastifizierter Rost mit Schienen Parilla Plástica Plastik kaplı çelik raf Пластифицированные решетки с направляющими</p>	<p>Cassettiera 1/2 Drawer set 1/2 Bloc de tiroirs 1/2 Schubladenblöcke 1/2 Cajón 1/2</p>

## EURONORM



PTR216CN3N

PTR217CN3N

PTR160CN3N



PTP216CN3N

PTP217CN3N

PTP160CN3N

### ALTRE CARATTERISTICHE - OTHER FEATURES - CARACTÉRISTIQUES

Cassetto neutro su vano motore predisposto per accogliere n° 3 contenitori 60x40; Cassettiera neutra a 7 cassetti; Quattro coppie guide di serie per vano porta; Bacinelle e contenitori in plastica non inclusi; Piano in granito

Neutral drawer on the cooling unit suited to hold n° 3 basin 60 x 40; neutral 7 drawer kit; standard n° 4 pairs of guides for each door; plastic basin not included; granite top

Tiroir neutre au dessus du compartiment moteur prévu pour accueillir 3 conteneurs 60x40. Bloc tiroir neutre composé de 7 tiroirs, quatre paires de glissières de série par porte, bacs et conteneurs en plastique non inclus. Dessus en granit

Нейтральный выдвижной ящик над холодильным блоком, рассчитанный на 3 контейнера 60x40; семь нейтральных выдвижных ящиков; стандартное количество направляющих для каждой двери – 4 пары; пластиковые контейнеры не входят в комплект; рабочая поверхность из гранита

Modello Model Modell Modelo Model Модель	Price	Temperature	Capacity	Refrig. Power	Voltage	Abs. Power	Dimensions	Packing Dim.	N° pans	Pan Cooler	Weight
	€	°C	Lt	Watt	Volt/Hz	Watt	WxDxH cm	WxDxH cm	not included	Model	kg
PTR160CN3N		-2° +8°	395	532	220-240/50	451	160x80x145	172x91x131	10+3	ATR160*	230
PTP160CN3N		-2° +8°	395	407	220-240/50	331	160x80x850	172x91x110	10+3		180
PTR216CN3N		-2° +8°	615	550	220-240/50	472	217x80x145	229x91x131	15+3	ATR217*	400
PTP216CN3N		-2° +8°	615	407	220-240/50	337	217x80x850	229x91x110	15+3		342
PTR217CN3N		-2° +8°	395	550	220-240/50	466	217x80x145	229x91x131	10+10	ATR217*	400
PTP217CN3N		-2° +8°	395	407	220-240/50	331	217x80x850	229x91x110	10+10		342

\*Configurazioni vaschette a pag. 71 - Pan Size & Configurations at page 71



PTR16C3

PTR216C3

PTR217C3



PTP16C3

PTP216C3

PTP217C3

### ALTRE CARATTERISTICHE - OTHER FEATURES - CARACTÉRISTIQUES

Piano in granito, Piedi inox; Tre cassetti neutri su vano motore pred per contenitori 60x40; Cassettiera neutra a 6 cassetti; Quattro coppie guide di serie per vano porta; Bacinelle e contenitori in plastica non inclusi

Granite top, S/S feet, n° 3 neutral drawers on the cooling unit suited for basin 60 x 40, neutral 6 drawer kit; standard n° 4 pairs of guides for each door; plastic basin not included

Dessus en granit, pieds inox, trois tiroirs neutres au dessus du compartiment moteur prévu pour conteneurs 60x40. Bloc tiroir neutre à 6 tiroirs, quatre paires de glissières de série par porte, bacs et conteneurs en plastique non inclus

Гранитная столешница; ножки из нержавеющей стали; три выдвижных ящика над холодильным блоком, рассчитанных на контейнеры 60x40; шесть нейтральных выдвижных ящиков; стандартное количество направляющих для каждой двери – 4 пары; пластиковые контейнеры не входят в комплект

Modello Model Modell Modelo Model Модель	Price	Temperature	Capacity	Refrig. Power	Voltage	Abs. Power	Dimensions	Packing Dim.	N° pans	Pan Cooler	Weight
	€	°C	Lt	Watt	Volt/Hz	Watt	WxDxH cm	WxDxH cm	not included	Model	kg
PTR16C3		-2° +8°	395	532	220-240/50	451	160x80x145	172x91x131	10+3	ATR166*	230
PTP16C3		-2° +8°	395	407	220-240/50	331	160x80x850	172x91x110	10+3		180
PTR216C3		-2° +8°	615	550	220-240/50	472	217x80x145	229x91x131	15+3	ATR217*	400
PTP216C3		-2° +8°	615	407	220-240/50	337	217x80x850	229x91x110	15+3		342
PTR217C3		-2° +8°	395	550	220-240/50	466	217x80x145	229x91x131	10+9	ATR217*	400
PTP217C3		-2° +8°	395	407	220-240/50	331	217x80x850	229x91x110	10+9		342

\*Configurazioni vaschette a pag. 71 - Pan Size & Configurations at page 71

## EURONORM



PTR2003P



PTR200



PTP2003P



PTP200

### ALTRE CARATTERISTICHE - OTHER FEATURES - CARACTÉRISTIQUES

Piedi inox; Cassettiera neutra a 6 cassetti; Quattro coppie guide di serie su ogni vano porta; Bacinelle e contenitori in plastica non inclusi; Piano in granito

S/S feet; neutral 6 drawer kit; standard n° 4 pairs of guides for each door; plastic basin not included; granite top

Pieds inox. Bloc tiroirs neutre à 6 tiroirs, quatre paires de glissières de série par porte, bacs et conteneurs en plastique non inclus, Dessus en granit

Ножи из нержавеющей стали; шесть нейтральных выдвигаемых ящиков; стандартное количество направляющих для каждой двери – 4 пары; пластиковые контейнеры не входят в комплект; гранитная столешница

Modello Model Modell Modelo Model Модель	Price	Temperature	Capacity	Refrig. Power	Voltage	Abs. Power	Dimensions	Packing Dim.	N° pans	Pan Cooler	Weight
		°C	Lt	Watt	Volt/Hz	Watt	WxDxH cm	WxDxH cm	Not included	Model	kg
PTR2003P		-2° +8°	615	550	220-240/50	472	200x80x145	212x91x131	15	ATR200	320
PTP2003P		-2° +8°	615	407	220-240/50	337	200x80x850	212x91x110	15		270
PTR200		-2° +8°	395	550	220-240/50	466	200x80x145	212x91x131	10+6	ATR200	330
PTP200		-2° +8°	395	407	220-240/50	331	200x80x850	212x91x110	10+6		270

\*Configurazioni vaschette a pag. 71 - Pan Size & Configurations at page 71

### Accessori - Accessories - Accessoires - Zubehör - Accesorios - Seçenekleri - Доп. опция

Questi accessori possono essere ordinati esclusivamente insieme al prodotto a cui si riferiscono, e non possono essere ordinati separatamente. I prezzi degli accessori, indicati in questo listino, sono solo incrementi e non normali prezzi di vendita. Per ordini separati è necessario consultare il listino ricambi non incluso in questo catalogo.

Those options are to be ordered only at the moment of ordering a corresponding model and it is impossible to order them separately. The price of the accessories represents only the price increasing and it isn't the accessories price list. To order other accessories, please, check a separate "Spare parts list price".

Ces accessoires ne peuvent être commandés à ce prix qu'avec le meuble, et ne peuvent pas l'être séparément. Pour commande séparée uniquement d'accessoires, il est nécessaire de consulter le tarif pièces détachées non inclu dans ce catalogue.

Dieses Zubehör kann nur ausschließlich in Phase der Bestellung des Produktes bestellt werden, auf die sie sich beziehen, und können nicht separat bestellt werden. Für die Bestellung von Ersatzteilen ist der Ersatzteilkatalog zu konsultieren der nicht in diesem Listenpreis beigefügt ist.

Estos accesorios se pueden ordenar exclusivamente en fase de pedido del producto al que se refieren, y no se pueden pedir separadamente. Los precios de los accesorios, indicados en este listín, son sólo incrementos y no normales precios de venta. Por pedidos separados es necesario consultar el listín accesorios no incluido en este listín.

Эти аксессуары должны быть заказаны вместе с основными моделями и не могут поставляться отдельно. В случае заказа этих опций к цене основной модели надо будет добавить цену опции. Для заказа остальных аксессуаров и запасных частей, пожалуйста, смотрите отдельный прайс-лист «аксессуары».

H.A.C.C.P.	600x400	600x400	600x400	
Controllo H.A.C.C.P. H.A.C.C.P. Electronic control Contrôle électronique H.A.C.C.P. Elektronische Steuerung H.A.C.C.P. Control electrónico H.A.C.C.P. Elektronik kontrol H.A.C.C.P. Электронное управление Функция H.A.C.C.P.	Griglia Inox 600X400 Inox shelf 600X400 Grille Inox 600X400 Plastifizierter Rost 600X400 Parilla acero Inox 600X400 Paslanmaz çelik raf 600X400 решетки из нержавеющей стали 600X400	Griglia plastificata 600X400 Plastic-coated shelf 600X400 Grille plastifiée 600X400 Plastifizierter Rost 600X400 Parilla Plastificada 600X400 Plastik kapli çelik raf 600X400 Пластифицированные решетки 600X400	Bacinella in plastica 600x400 Dough-pan 600x400 Bac en plastique 600x400 Plastikbehälter 600x400 Barreño en plástico 600x400 Plastik balik kabi 600x400 противень для теста 600x400	

## PREPTOP - PAN COOLERS GASTRONORM GN 1/1



ATR140



ATR160



ATR180



ATR200



ATR217

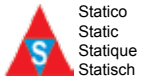
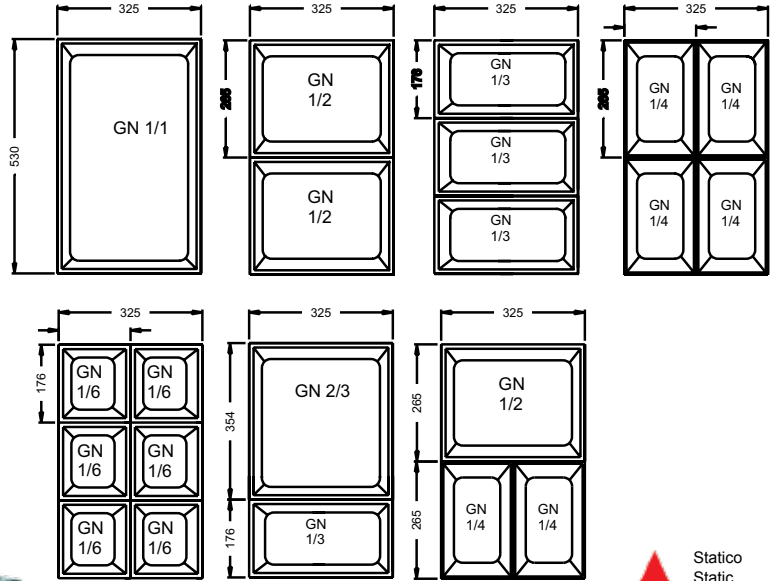

### ALTRE QUALITÀ - OTHER FEATURES -

Interno esterno inox; Refrigerazione statica; Evaporazione automatica acqua di condensa; Bacinelle non incluse

Internal/External in S/S; static refrigeration, automatic evaporation of the condensing water; basin not included

intérieur/extérieur en acier inox, réfrigération statique, évaporation automatique des eaux de condensat, bacs non inclus

Aussen/Innen Inox; Kühlung statisch Automatische Abtauwasserverdampfung; Behälterb nicht inbegriffen

Interno/externo inox; refrigeración estática; evaporación automática agua de condensación; barreñas no incluidas

Paslanmaz Çelik İç ve Dış Gövde; Statik Soğutma, yoğunlaşan suyun otomatik evaporasyonu; küvet dahil değil

Внутренняя и внешняя отделка из нержавеющей стали, статичное охлаждение, автоматическое испарение, контейнеры не входят в комплект

Modello Model Modell Modelo Model Model Модель	Price	Temperature	Capacity	Refrig. Power	Voltage	Abs. Power	Dimensions	Packing Dim.	GN Pans	Weight
		°C	Nr. GN pans	Watt	Volt/Hz	Watt	WxDxH cm	PxHxL cm	Not included	kg
ATR140		+4° +10°		125	220-240/50	120	140x38x45	146x43x30	Optional	50
ATR160		+4° +10°	6 x GN1/3 1 x GN2/8	125	220-240/50	120	160x38x45	166x43x30	Optional	60
ATR180		+4° +10°	8 (1/3)	125	220-240/50	120	180x38x45	186x43x30	Optional	75
ATR200		+4° +10°	9 (1/3)	143	220-240/50	135	200x38x45	206x43x30	Optional	79
ATR217		+4° +10°	10 (1/3)	143	220-240/50	135	217x38x45	223x43x30	Optional	85

## PREPTOP - PAN COOLERS GASTRONORM GN 1/1

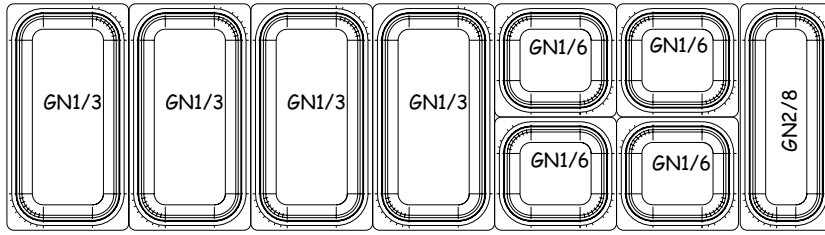

ATR160

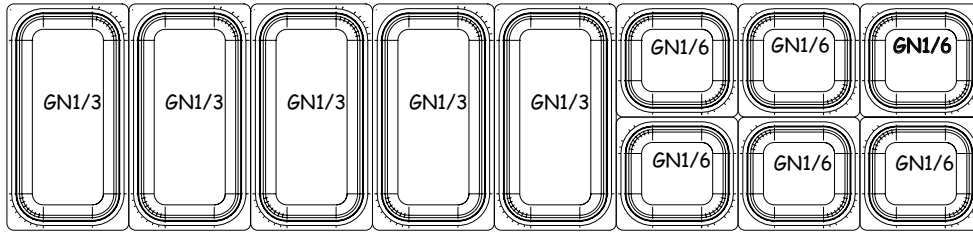

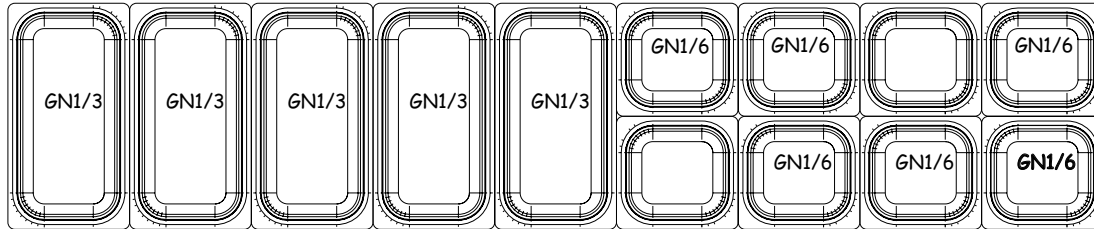

ATR180

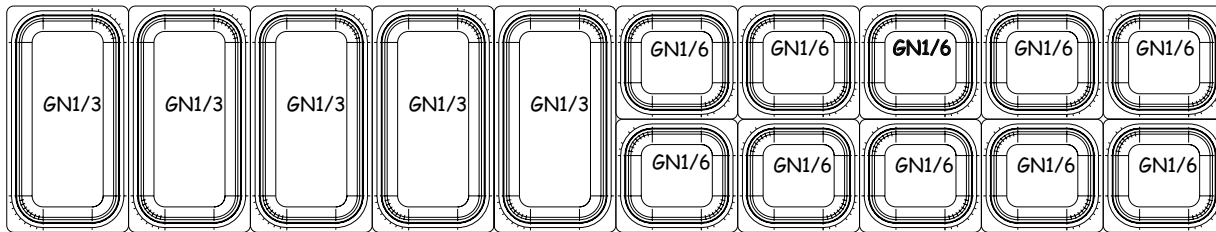

ATR200

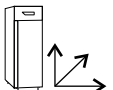

ATR217

Modello Model Modell Modelo Model Modell Модель	 Description	 Dimensions (mm)	 Price
GN-1115	BACINELLA INOX GN 1/1 INOX PAN GN 1/1	325x530xH150	
GN-1215	BACINELLA INOX GN 1/2 INOX PAN GN 1/2	325x265xH150	
GN-2815	BACINELLA INOX GN 2/8 INOX PAN GN 2/8	325x132xH150	
GN-1315	BACINELLA INOX GN1/3 INOX PAN GN1/3	325x176xH150	
GN-1615	BACINELLA INOX GN1/6 INOX PAN GN1/6	162x176xH150	
GNC-13	COPERCHIO INOX BACINELLA GN 1/3 COVER INOX PAN GN 1/3		
GNC-16	COPERCHIO INOX BACINELLA GN 1/6 COVER INOX FOR GN 1/6 PAN		
GNC-28	COPERCHIO INOX BACINELLA GN 2/8 COVER INOX FOR GN 2/8 PAN		
GNC-11	COPERCHIO INOX PER BACINELLA GN 1/1 COVER INOX FOR GN 1/1 PAN		
GNC-12	COPERCHIO INOX PER BACINELLA GN 1/2 COVER INOX FOR GN 1/2 PAN		



**GOLD**

PREP STATION

SALADETTES

PIZZA PREP TABLES

PAN COOLERS





**DESMON**  
Food Service Equipment

## FOOD PREPARATION TABLES - SALADETTES - PIZZA PREP TABLES - PREP TOP



Controllo Elettronico  
H.A.C.C.P di serie  
Unità refrigerante estraibile  
Sbrinamento automatico  
Evaporazione automatica  
Gas : R404a  
Isolamento 60 mm privo di CFC/HCFC

Esterno/Interno in acciaio inox AISI 304  
Angoli interni arrotondati  
Piedini regolabili in Inox  
Porte autochiudenti  
Griglie plastificate dim. 530x325mm  
Coppie guide per Mod. Pizza  
Accessori a richiesta:

Griglie inox dim. 530x650mm; Serratura;  
Ruote; Bacinelle GN;



Electronic control  
H.A.C.C.P. as standard  
Slide out refrigeration system  
Auto defrost & Evaporation  
Gas: R404a  
Polyurethane insulation 60 mm  
CFC/HCFC free

304 Grade Stainless Steel Interior/Exterior  
Interior rounded corner  
Adjustable Inox feet  
Self closing doors  
Plastic-coated shelves  
dim. 530x325 mm  
On request available:

Stainless Steel shelves; Door lock; Castors;  
Drawer kits; Pans GN;



Contrôle électronique  
Contrôle électronique H.A.C.C.P  
Unité hermétique extractible sur glissières  
Dégivrage automatique avec  
réévaporation des eaux  
Gaz: R404a  
Isolation épaisseur 60 mm sans CFC/

HCFC  
Revêtement Intérieur/extérieur  
en Acier Inox AISI 304  
Angles arrondis intérieurs  
Pieds réglables en Acier Inox 304  
Portes avec fermeture automatique  
Grille Plastifiée dim. 530x325 mm

Options:  
Grille Inox, Serrure à clé, Bacs GN;



Elektronische Steuerung  
H.A.C.C.P Serienmäßig  
Kühlaggregat ausziehbar  
Automatische Abtaung  
Automatische Abtauwasserverdampfung  
Kühlmittel R404a  
Isolationsstärke 60mm ohne CFC und

HCFC  
Aussen / Innen Inox (Edelstahl) AISI 304  
Intern abgerundete Ecken Reinigungsfreundlich  
Höhenverstellbare Inoxfüsse  
Tür selbstschliessend  
Plastikbeschichtete Roste GN 1/1 ABMessung  
530x325mm

Zubehör auf Anfrage :  
Roste InoxGN 1/1 ABMessung 530x325mm  
Türschloss; Räder.



Control electrónico  
H.A.C.C.P. en serie  
Unidad refrigerante extraible  
Descongelación automática  
Evaporación automática  
Gas:R404a  
Aislamiento 60mm sin empleo de CFC y

HCFC  
Externo/Interno en acero inox AISI 304  
Esquinas internas redondeadas  
Soportes ajustables en Inox  
Puertas autocerrantes  
Parrillas plastificadas dim.530x325mm  
Accesorios bajo pedido

Parrillas inox. dim.53x650mm; Cerradura;  
Ruedas; Cajón;



Elektronik kontrol  
H.A.C.C.P. fonksiyonu standart  
Slide out refrigeration system  
Otomatik defrost & evaporasyon  
Gaz: R404a  
Poliüretan izolasyon 60 mm  
CFC/HCFC free

304 Kalite Paslanmaz Çelik İç ve Dış Gövde  
Yuvarlatılmış İç Köşeler  
Ayarlanabilir Paslanmaz Ayaklar  
Kendinden kapanan kapılar  
Plastik Kaplı Raflar Ölçüsü: 530x325 mm  
İsteğe bağlı olarak:  
Paslanmaz Çelik Raflar; Sırtlı Üst Tabla; Kapı Kili-

di; Tekerlekler; Çekmece Takımları.



Электронное управление  
Функция H.A.C.C.P. в комплекте  
Выдвижной холодильный агрегат  
Автоматическое размораживание и  
испарение  
Фреон R404a  
Полиуретановый изолирующий слой

60мм, без CFC/HCFC  
Внешняя и внутренняя отделка из  
нержавеющей стали AISI 304  
Закругленные внутренние углы  
Регулируемые ножки из нержавеющей стали  
Самозакрывающиеся двери  
Решетки 530x325мм покрытые пластиком

Дополнительно заказываются:  
Решетки из нержавеющей стали, рабочая  
поверхность с панелью для защиты  
от брызг, замок для дверей, ножки с  
колесиками, набор выдвижных ящиков,GN  
контейнеры

## SALADETTES GASTRONORM GN 1/1



TGS2S



TGS3S

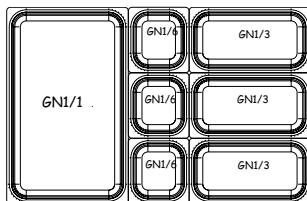

Una griglia plastificata per porta  
Porte autochiudenti  
Haccp di serie  
Bacinelle GN non incluse

1 plastic coated shelf for each door. Self closing door  
HACCP digital control  
Basins option

Une grille plastifiée par porte,  
porte à fermeture automatique,  
Haccp de série, bacs GN non  
inclus. Dessus en granit

На каждую дверь идет по одной  
пластифицированной решетке  
Самозакрывающиеся двери  
HACCP в комплекте  
Контейнеры GN в комплект не  
входят

Modello Model Modell Modelo Model Модель	Price	Temperature	Capacity	Refrig. Power	Voltage	Abs. Power	Dimensions	Packing Dim.	Shelves	Ambient Temp.	Weight
	€	°C	Lt	Watt	Volt/Hz	Watt	WxDxH cm	WxDxHcm	N°	°C	kg
TGS2S		0° +10°	280	387	220-240/50	325	146x70x85	158x81x117	2	+43	150
TGS3S		0° +10°	540	555	220-240/50	440	194,5x70x85	207x81x117	3	+43	180



FPTM2N-70



FPTM3N-70



FPTM2N-70

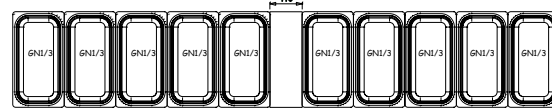

FPTM3N-70

Una griglia plastificata per vano porta  
Porte autochiudenti  
Haccp di serie  
Cassetto refrigerato su vano motore

1 plastic coated shelf for each door.  
Self closing door  
HACCP digital control  
Refrigerated drawer onto the compressor room

Une grille plastifiée par porte,  
porte à fermeture automatique,  
Haccp de série, bacs GN non inclus.

На каждую дверь идет по одной  
пластифицированной решетке  
Самозакрывающиеся двери  
HACCP в комплекте  
Охлаждаемый выдвижной ящик над холодильным блоком

Modello Model Modell Modelo Model Модель	Price	Temperature	Capacity	Refrig. Power	Voltage	Abs. Power	Dimensions	Packing Dim.	GN Pans	Ambient Temp.	Weight
	€	°C	Lt	Watt	Volt/Hz	Watt	WxDxH cm	WxDxH cm	not included	°C	kg
FPTM2N-70		0° +10°	280	308	220-240/50	270	146x81x118		8	+43	130
FPTM3N-70		0° +10°	540	407	220-240/50	330	195x81x118		10	+43	180

### Accessori - Accessories - Accessoires - Zubehör - Accesorios - Seçenekleri - Доп. опция

Serratura Door lock Serrure à clé Türschloss Cerradura con llave Kilitlenebilir Kapılar Замок на двери с ключами	Ruote piroettanti, 2 con freno Lockable castors, 2 with brakes Roulettes pivotantes, 2 avec freins Fussrollen, zwei mit Bremsen Ruedas giratorias, dos con freno Kilitli Tekerlekler, iki Frenli Ножи с колесиками, две – с тормозами	Griglia Inox con Guide inox Stainless Steel shelf with guides Grille acier inox avec glissières Inox Rost mit Schienen Parilla acero Inox con guías Paslanmaz çelik raf raylarla beraber Решетки из нержавеющей стали с направляющими	Kit Griglia plastificata con guide Plastic-coated shelf with guide Grille plastifiée Plastifizierter Rost mit Schienen Parilla Plástica Plastik kaplı çelik raf Пластифицированные решетки с направляющими	Piano di lavoro con griglie e cassetti scorrevoli Worktop with sliding drawers and racks

## EURONORM 60X40



FPTM2N-80



FPTM3N-80

Quattro coppie guide ad L per vano porta  
Porte autochiudenti  
Haccp di serie

4 L shape guides for each door.  
Self closing door  
HACCP digital control

4 pair de support en "L" par porte, porte à fermeture automatique, Haccp de série, bacs GN non inclus.

На каждую дверь идет по 4 пары L-образных направляющих (для Евро-порт контейнеров)  
Самозакрывающиеся двери  
HACCP в комплекте

Modello Modell Modelo Model Модель	Price	Temperature	Capacity	Refrig. Power	Voltage	Abs. Power	Dimensions	Packing Dim.	GN Pans	Ambient Temp.	Weight
	€	°C	Lt	Watt	Volt/Hz	Watt	WxDxH cm	WxDxH cm	not included	°C	kg
FPTM2N-80		0° +10°	398	308	220-240/50	270	166x91x118		8	+43	150
FPTM3N-80		0° +10°	620	407	220-240/50	348	224x91x118		12	+43	210

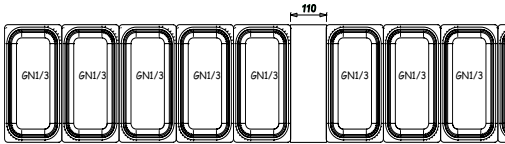

FPTM2N-80

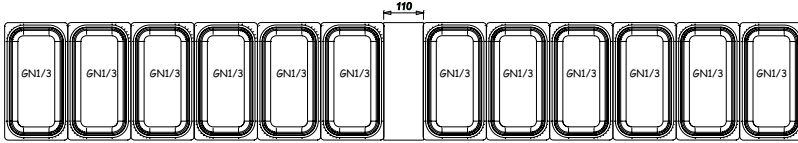

FPTM3N-80

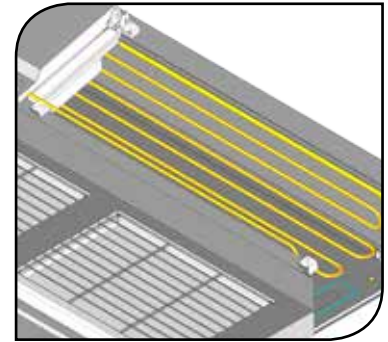

Piping foamed in place  
(all model 70 / 80)

### Accessori - Accessories - Accessoires - Zubehör - Accesorios - Seçenekleri - Доп. опция

Piano di lavoro con griglie e cassetti scorrevoli Worktop with sliding drawers and racks	Ruote piroettanti, 2 con freno Lockable castors, 2 with brakes Roulettes pivotantes, 2 avec freins Fussrollen, zwei mit Bremsen Ruedas giratorias, dos con freno Kilitli Tekerlekler, iki Frenli Ножки с колесиками, две – с тормозами	Griglia Inox 600X400 Inox shelf 600X400 Grille Inox 600X400 Plastifizierter Rost 600X400 Parilla acero Inox 600X400 Paslanmaz çelik raf 600X400 решетки из нержавеющей стали 600X400	Griglia plastificata 600X400 Plastic-coated shelf 600X400 Grille plastifiée 600X400 Plastifizierter Rost 600X400 Parilla Plastificada 600X400 Plastik kapli çelik raf 600X400 Пластифицированные решетки 600X400	Teglia alluminio 600x400 Aluminum bakery-pan 600x400 Plaque en aluminium 600x400 Aluminium-Backbleche 600x400 Bandeja de aluminio 600x400 Aliminyum Bakery Tepsisi Алюминиевый противень для выпечки 600x400
Cassettiera 1/2 Drawer set 1/2 Bloc de tiroirs 1/2 Schubladenblöcke 1/2 Cajón 1/2	Cassettiera 1/2 Drawer set 1/2 Bloc de tiroirs 1/2 Schubladenblöcke 1/2 Cajón 1/2	Cassettiera 1/2 Drawer set 1/2 Bloc de tiroirs 1/2 Schubladenblöcke 1/2 Cajón 1/2	Cassettiera 1/2 Drawer set 1/2 Bloc de tiroirs 1/2 Schubladenblöcke 1/2 Cajón 1/2	Cassetto neutro su vano motore Neutral drawer above the cooling unit Tiroir neutre au dessus du compartiment moteur. Ungekühlte Lade auf dem Aggregatfach Cajón neutro sobre vano motor Motor boşluğu üzerinde sogutmalı çekmecelik Нейтральный ящик над холодильным агрегатом
FPTMXN-70	FPTMXN-70	FPTMXN-80	FPTMXN-80	FPTMXN-80

## EURO NORM 60X40



GPZ165

GPZ165A





GPZ166

GPZ166A











## ALTRE CARATTERISTICHE - OTHER FEATURES - CARACTÉRISTIQUES

 Quattro contenitori in PVC 60x40 per vano porta; Porte autochiudenti; Haccp di serie; Isolamento da 60 mm; Cassetto neutro su vano motore; Cassettera neutra a 7 cassetti contenitori inclusi; Piano in granito

 N° 4 PVC basin 60x40 on each door; self closing door; standard HACCP; insulation thickness 60 mm; neutral drawer on the cooling unit. Neutral 7 drawer kit; basin not included. Granite top

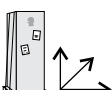
 Quatre conteneurs en PVC 60x40 par porte, Pporte à fermeture automatique, Haccp de série isolation de 60 mm, Tiroir neutre au dessus du compartiment moteur, Bloc tiroir neutre composé de 7 tiroirs avec conteneurs inclus, Dessus en granit

 4 PVC контейнера 60x40 для каждой двери, самозакрывающиеся двери, HACCP в комплекте, толщина изоляции 60мм, нейтральный выдвижной ящик над холодильным блоком, семь нейтральных выдвижных ящиков с контейнерами в комплекте. Гранитная столешница

Modello Model Modell Modelo Model Модель	 Price	 Temperature	 Capacity	 Refrig. Power	 Voltage	 Abs. Power	 Dimensions	 Packing Dim.	 N° pans	 Pan Cooler	 Weight
		°C	Lt	Watt	Volt/Hz	Watt	WxDxH cm	WxDxH cm	included	Model	kg
GPZ165		-2° +8°	176	387	220-240/50	325	166x80x85	178x91x110	11		300
GPZ165A		-2° +8°	176	387	220-240/50	325	166x80x147	178x91x131	11	GA166*	350
GPZ166		-2° +8°	398	407	220-240/50	331	166x80x85	178x91x110	8		300
GPZ166A		-2° +8°	398	407	220-240/50	331	166x80x147	178x91x131	8	GA166*	350

\*Configurazioni vaschette a pag. 78 - Pan Size & Configurations at page 78



GPZ223

GPZ223A





GPZ225

GPZ225A











## ALTRE CARATTERISTICHE - OTHER FEATURES - CARACTÉRISTIQUES

 Quattro contenitori in PVC 60x40 per vano porta; Porte autochiudenti; Haccp di serie; Isolamento da 60 mm; Cassetto neutro su vano motore; Cassettera neutra a 7 cassetti contenitori inclusi; Piano in granito

 N° 4 PVC basin 60x40 on each door; self closing door; standard HACCP; insulation thickness 60 mm; neutral drawer on the cooling unit. Neutral 7 drawer kit; basin not included. Granite top

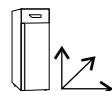
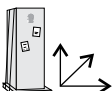
 Quatre conteneurs en PVC 60x40 par porte, Pporte à fermeture automatique, Haccp de série isolation de 60 mm, Tiroir neutre au dessus du compartiment moteur, Bloc tiroir neutre composé de 7 tiroirs avec conteneurs inclus, Dessus en granit

 4 PVC контейнера 60x40 для каждой двери, самозакрывающиеся двери, HACCP в комплекте, толщина изоляции 60мм, нейтральный выдвижной ящик над холодильным блоком, семь нейтральных выдвижных ящиков с контейнерами в комплекте.

Modello Model Modell Modelo Model Модель	 Price	 Temperature	 Capacity	 Refrig. Power	 Voltage	 Abs. Power	 Dimensions	 Packing Dim.	 N° pans	 Pan Cooler	 Weight
		°C	Lt	Watt	Volt/Hz	Watt	WxDxH cm	WxDxH cm	Included	Model	kg
GPZ223		-2° +8°	398	407	220-240/50	331	223x80x85	235x91x110	15		400
GPZ223A		-2° +8°	398	407	220-240/50	331	223x80x147	235x91x131	15	GA223*	450
GPZ225		-2° +8°	620	407	220-240/50	348	225x80x85	237x91x110	12		400
GPZ225A		-2° +8°	620	407	220-240/50	348	225x80x147	237x91x131	12	GA223*	450

\*Configurazioni vaschette a pag. 78 - Pan Size & Configurations at page 78

## PREPTOP - PAN COOLERS GASTRONORM GN 1/1

# Pan arrangements

### COMPOSITIONS

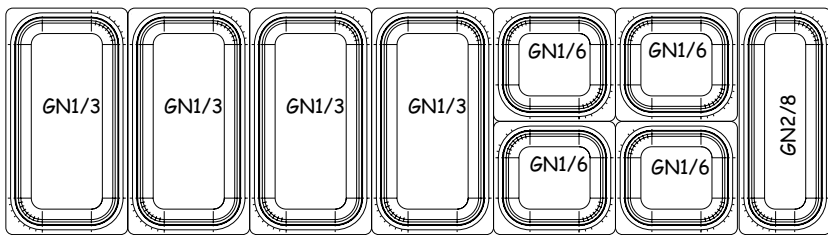

GA166

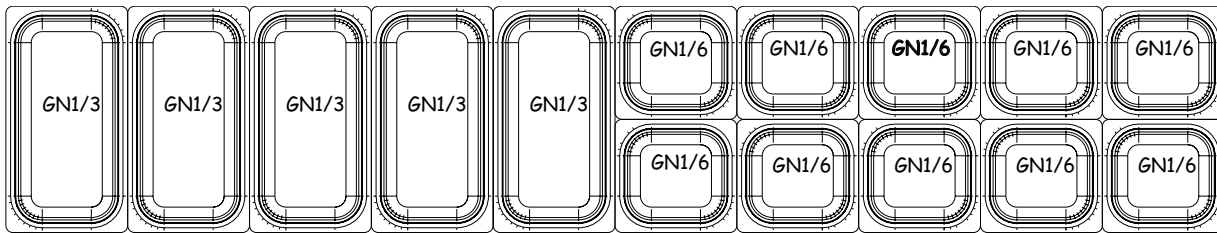

GA223

#### ALTRE CARATTERISTICHE - OTHER FEATURES -

Interno esterno acciaio inox AISI 304; Refrigerazione statica; Evaporazione automatica acqua di condensa; Bacinelle non incluse

Internal/External in S/S AISI 304, static refrigeration, automatic evaporation of the condensing water, basin not included

Intérieur/extérieur en acier inox AISI 304, Réfrigération statique, évaporation automatique des eaux de condensat, bacs non inclus

Aussen/Innen Inox  
Kühlung statisch  
Automatische Abtauwasserverdampfung  
Behälterb nicht inbegriffen

Interno/Externo acero inox AISI 304; Refrigeración estática; Evaporación automática agua de condensación; barreñas no incluidas



AISI 304 Paslanmaz Çelik İç ve Dış Gövde; Statik Soğutma, yoğunlaşan suyun otomatik evaporasyonu; küvet dahil değil

Внешняя и внутренняя отделка из нержавеющей стали AISI 304; статичное охлаждение; автоматическое испарение; контейнеры в комплект не входят

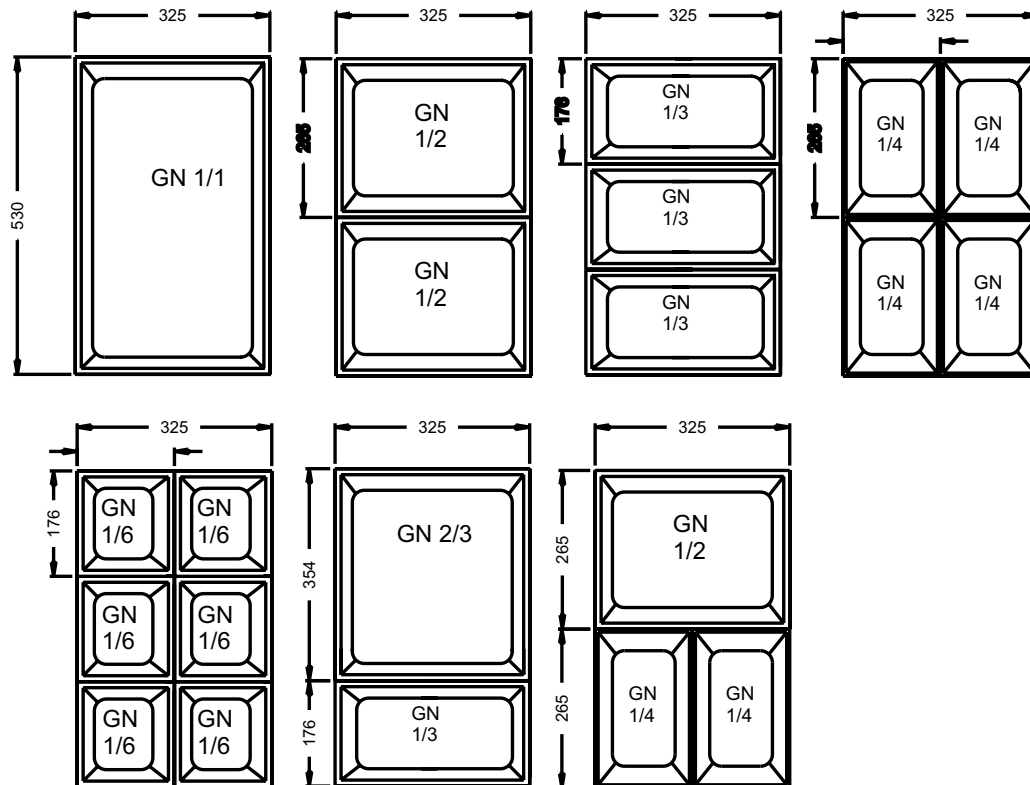

Modello Modell Modelo Model Модель	Price €	Temperature °C	Capacity Nr. GN pans	Refrig. Power Watt	Voltage Volt/Hz	Abs. Power Watt	Dimensions WxDxH cm	Packing Dim. WxDxH cm	GN Pans <b>Not included</b>	Weight kg
GA166		+4°+10°	6(1/3)+1(2/8)	125	220-240/50	120	166x38x45	172x43x30	Optional	50
GA223		+4°+10°	10(1/3)	143	220-240/50	135	223x38x45	229x43x30	Optional	58

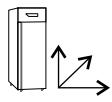
**PREP TOP - PAN COOLERS  
GASTRONORM GN 1/1**

Modello Model Modell Modelo Model Модель	 Description	 Dimensions (mm)	 Price
GN-1115	BACINELLA INOX GN 1/1 INOX PAN GN 1/1	325x530xH150	
GN-1215	BACINELLA INOX GN 1/2 INOX PAN GN 1/2	325x265xH150	
GN-2815	BACINELLA INOX GN 2/8 INOX PAN GN 2/8	325x132xH150	
GN-1315	BACINELLA INOX GN1/3 INOX PAN GN1/3	325x176xH150	
GN-1615	BACINELLA INOX GN1/6 INOX PAN GN1/6	162x176xH150	
GNC-13	COPERCHIO INOX BACINELLA GN 1/3 COVER INOX PAN GN 1/3		
GNC-16	COPERCHIO INOX BACINELLA GN 1/6 COVER INOX FOR GN 1/6 PAN		
GNC-28	COPERCHIO INOX BACINELLA GN 2/8 COVER INOX FOR GN 2/8 PAN		
GNC-11	COPERCHIO INOX PER BACINELLA GN 1/1 COVER INOX FOR GN 1/1 PAN		
GNC-12	COPERCHIO INOX PER BACINELLA GN 1/2 COVER INOX FOR GN 1/2 PAN		

## BAR SYSTEM



S1-BR22



B2-BR24

### MODELLO CON TOP - MODEL WITH TOP - MODÈLE AVEC DESSUS - MODELO CON ENCIMERA

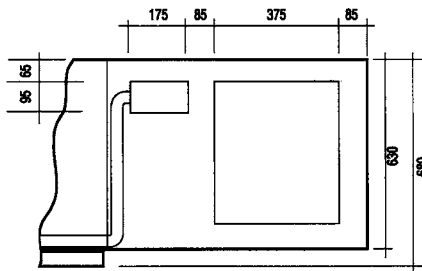
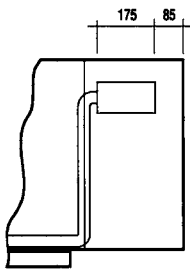

Predisposto con foratura a pavimento per passaggio tubazione.  
 Predisposed with perforation to floor for passage pipeline.  
 Prédisposé avec crevaisson à plancher pour passage canalisation.  
 Mit Ausschnitten vorgesehen für Durchgang der Rohrleitungen  
 Predispuesto con agujero al suelo para el pasaje de la tubería

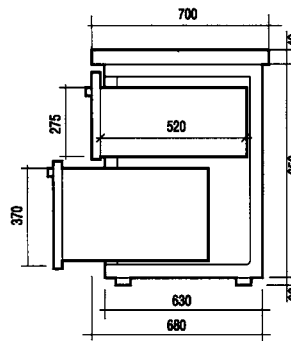

Dimensioni cassetti  
 Dimensions drawers  
 Dimensions tiroirs  
 ABmessungen Schubladen  
 Dimensiones cajones

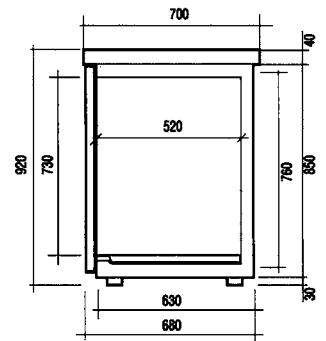

Dimensioni sportello  
 Dimensions half-door  
 Dimensions portillon  
 ABmessungen Tür  
 Dimensiones ventanillas

### MODELLO SENZA TOP - MODEL WHITOUT TOP - MODÈLE SANS DESSUS



S2-BR32/SP

Disponibile su richiesta senza piano con una riduzione del 15% sul prezzo.( per ordinare es. B2-BR32 /SP)  
 Available on request without top with a 15% reduction on the price (to order es. B2-BR32 /SP).  
 Disponible sur demande sans dessus avec une réduction de 15% sur le prix. (es. B2-BR32 /SP)  
 Auf Anfrage ohne Abdeckung erhältlich -15% des Listenpreises (für die Bestellung B2-BR32/SP)  
 Disponible bajo pedido sin plano con una reducción del 15% sobre el precio (es. B2-BR32 /SP)



## BAR SYSTEM



Serratura di serie  
Serrure de série  
Drawers lock as standard  
Türschloss Serienmäßig  
Cerradura en serie



Serratura di serie  
Serrure de série  
Drawers lock as standard  
Türschloss Serienmäßig  
Cerradura en serie



Struttura rinforzata  
Structure renforcée  
Structural reinforcement  
Fußsteg  
Estructura reforzada

## CARATTERISTICHE - FEATURES - CARACTÉRISTIQUES

### BAR SYSTEM

Offre una serie enorme di elementi funzionali e versatili per ottimizzare il lavoro grazie ai lavelli, gocciolatoi, ed agli spazi sottostanti con cassetti e sportelli.

#### STRUTTURA

Dimensioni in mm includono gli zoccoli da 30mm. Sportelli e cassetti in acciaio inox. Interno acciaio inox

Pavimento rinforzato per 50 L KEG-EURO o barili - DIN. Canale di scarico con sifone

#### PIANO (Top)

Piano in acciaio inox con vasca e gocciolatoio (griglia) stampato con bordo perimetrale. Con troppo pieno sui lavelli e sifonatura.

[Rubinetteria e spillatore non compreso.](#)

Dimensioni livello 300x500

### BAR SYSTEM

offers a vast range of functional, versatile elements for optimising use and organization of work space on the top, thanks to bowls and drainers as well as the spaces beneath - with drawers, pan drawers and doors.

#### BODY

Measurements in mm, including two 30 mm high plinths. Doors, drawers in stainless steel. Internal covering: stainless steel. Parts with door and reinforced bottom. For 50 L KEG-EURO or DIN barrels. Water drain pipe with trap.

#### TOP

In stainless steel. Drawn drainer with grille. 40 mm outer retaining edge. Complete with drain/overflow pipe valve, drain connection for drainer and bowl plus trap and water taps.

[Without draft column and mixer.](#)

Sink dimensions: 300x500

### BAR SYSTEM

propose une importante série d'éléments fonctionnels et polyvalents afin d'optimiser le travail grâce aux évier, égouttoirs, et aux espaces de dessous avec tiroirs et portillons.

#### STRUCTURE

Dimensions en mm incluant les socles de 30 mm. Portillons et tiroirs en acier inox. Intérieur en acier inox.

Sol renforcé pour 50 L KEG-EURO ou barils - DIN. Canal d'évacuation avec syphon.

#### DESSUS (Top)

Dessus en acier inox avec cuve et égouttoir (grille) avec bords périmétraux moulés. Avec trop plein sur les évier et syphons.

[Robinetterie et tireuse non compris.](#) Di-

mensions évier 300x500

Modello Model Modell Modelo Model Модель	Price	Temperature	Nr. of doors	Nr. of Drawers	Sink	Mounting	Refrig. Power	Abs. Power	Dimensions	Packing Dim.	Weight
		°C	Nr.	Nr.	Nr.	Right / Left	Watt	Watt	WxDxH cm	WxDxH cm	kg
B1-BL2		+2° +8°	2	0	1	R (DX)	308	277	155x70x92	165x84x116	150
S1-BL2		+2° +8°	2	0	1	L (SX)	308	277	155x70x92	165x84x116	150
B1-BR22		+2° +8°	1	2	1	R (DX)	308	277	155x70x92	165x84x116	160
S1-BR22		+2° +8°	1	2	1	L (SX)	308	277	155x70x92	165x84x116	160
B1-BR24		+2° +8°	0	4	1	R (DX)	308	277	155x70x92	165x84x116	170
S1-BR24		+2° +8°	0	4	1	L (SX)	308	277	155x70x92	165x84x116	170
B2-BL2		+2° +8°	2	0	2	R (DX)	308	277	195x70x92	205x84x116	200
S2-BL2		+2° +8°	2	0	2	L (SX)	308	277	195x70x92	205x84x116	200
B2-BR22		+2° +8°	1	2	2	R (DX)	308	277	195x70x92	205x84x116	210
S2-BR22		+2° +8°	1	2	2	L (SX)	308	277	195x70x92	205x84x116	210
B2-BR24		+2° +8°	0	4	2	R (DX)	308	277	195x70x92	205x84x116	220
S2-BR24		+2° +8°	0	4	2	L (SX)	308	277	195x70x92	205x84x116	220
B2-BL3		+2° +8°	3	0	2	R (DX)	407	344	250x70x92	260x84x116	250
S2-BL3		+2° +8°	3	0	2	L (SX)	407	344	250x70x92	260x84x116	250
B2-BR32		+2° +8°	2	2	2	R (DX)	407	344	250x70x92	260x84x116	260
S2-BR32		+2° +8°	2	2	2	L (SX)	407	344	250x70x92	260x84x116	260
B2-BR34		+2° +8°	1	4	2	R (DX)	407	344	250x70x92	260x84x116	270
S2-BR34		+2° +8°	1	4	2	L (SX)	407	344	250x70x92	260x84x116	270
B2-BR36		+2° +8°	0	6	2	R (DX)	407	344	250x70x92	260x84x116	280
S2-BR36		+2° +8°	0	6	2	L (SX)	407	344	250x70x92	260x84x116	280

## BEER BOX





BB06 + BBUCE

### CARATTERISTICHE - FEATURES - CARACTÉRISTIQUES

 Mobile costruito a pannelli e montati mediante l'utilizzo di ganci ad eccentrico  
Pavimento rinforzato per la tenuta dei fusti di birra  
Pavimento interno in acciaio inox, il restante in acciaio zincato. Porta con guarnizione magnetica.  
Isolamento poliuretano espanso alta densità spessore 50mm.  
Monoblocco a sistema ventilato.  
Gas R404a  
Temperatura +2° +8°C

 • Unit consisting of complete panels with hidden fast-coupling system.  
• Reinforced bottom to support beer barrels.  
• Bottom in stainless steel, remaining panels in galvanised plate.  
• Door rebates fitted with magnetic gasket.  
• Heat insulation in high density polyurethane, thickness: 50 mm.  
Motor block:  
• Refrigerant gas: R404A  
• Electro-mechanical controls: on/off switch, temperature regulation thermostat.

 • Meuble constitué de panneaux pourvus d'un système d'accrochage rapide escamotable  
• Fond renforcé pour appuyer les barils de bière.  
• Fond en acier inox, ensemble des panneaux restant construit en tôle galvanisée  
• Portes avec joints magnétiques  
• Isolation en polyuréthane à haute densité. Epaisseur: 50 mm  
Monobloc moteur:  
• Installation réfrigérante avec système ventilé  
• Gaz réfrigérant: R 404A  
• Commandes électromécaniques: interrupteur général, thermostat de réglage de la température.

 Möbel in Paneelbauweise mit Exenterhakenverschlüssen  
Verstärkter Edelstahlboden für die Lagerung von Fässern  
FusSBoden innen in Inox – Struktur aus verzinktem Stahlblech  
Türverschluss mit magnetischer Dichtung  
Polyurethanisolation 50mm  
Wandstärke  
Monoblockaggregat  
Kühlmittel R404a  
– Arbeitstemperaturen +2°/+8°C

 Mueble construido con paneles montados a través del empleo de ganchos  
Suelo reforzado por el apoyo de barriles de cerveza  
Suelo interno en acero inox, el restante en acero cincado.  
Puerta con guarnición magnética. Aislamiento poliuretano extendido alta densidad de espesor 50mm. Monobloque con sistema ventilado  
Gas R404a  
Temperatura +2 +8 C







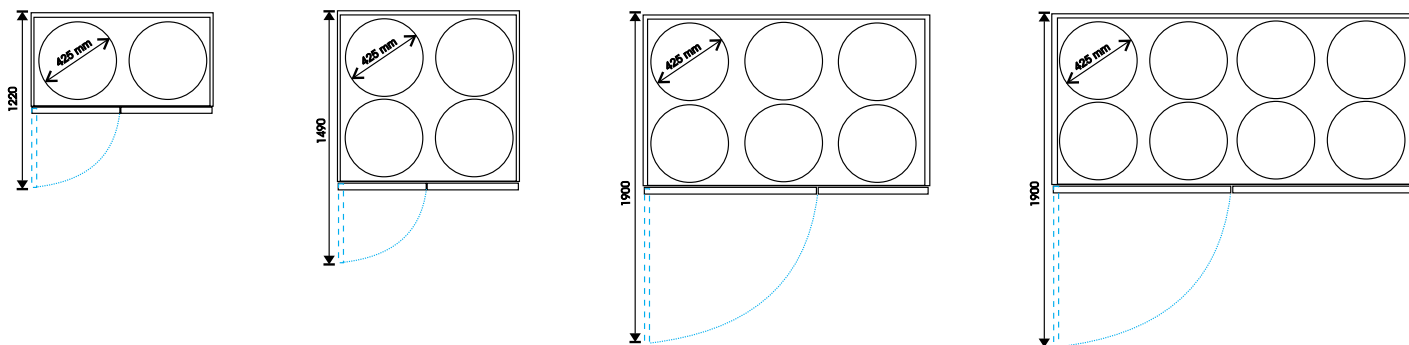

 • Ünite tamamen birbirine hızlı bağlanabilen panellerden oluşmaktadır.  
• Güçlendirilmiş alt bira fiçilerini taşıyacak şekilde yapılmıştır.  
• Alt parça paslanmaz, kalan paneller galvanizden yapılmaktadır.  
• Kapılarda manyetik conta bulunmaktadır.  
• Isı izolasyonu yüksek basınçlı poliüretan ile yapılmıştır. Kalınlık: 50 mm  
Motor Bloğu vardır.  
• Soğutma Gazı: R 404 A  
• Elektro-Mekanik Kontrol: Sıcaklık Regülasyonu Termostat ile Sağlanmaktadır.

 - В наборе идут готовые панели со скрытыми соединениями для быстрого монтажа  
- Усиленное дно для лучшей поддержки пивных бочек  
- Дно изготовлено из нержавеющей, а остальные панели – из оцинкованной стали  
- Магнитные прокладки дверей  
- Теплоизолирующий слой толщиной 50мм изготовленный из высокоплотного полиуретана  
Холодильный блок:  
- Фреон R404A  
- Электромеханический контроль: кнопка включения/выключения, регулировка температуры термостатом

## BEER BOX



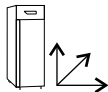
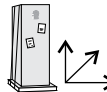







**BB06**

Modello Model Modell Modelo Model Модель	 Price	 Temperature	 Capacity	 Voltage	 Refrig. Power	 Abs. Power	 Cooling system	 Dimensions	 Packing Dim.	 Weight
		°C	Nr.		Watt	Watt	v/s	WxDxH cm	WxDxH cm	kg
BB02		-	2x50lt		-	-	-	108x72x95,5	115x100x40	60
BB04		-	4x50lt		-	-	-	108x98,5x95,5	115x100x45	65
BB06		-	6x50lt		-	-	-	148,5x98,5x95,5	155x100x55	70
BB08		-	8x50lt		-	-	-	189x98,5x95,5	195x100x60	80

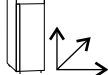
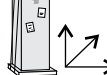

**BBUCE**

Modello Model Modell Modelo Model Модель	 Price	 Temperature	 Capacity	 Voltage	 Refrig. Power	 Abs. Power	 Cooling System	 Dimensions	 Packing Dim.	 Weight
		°C	Nr.	Volt/Hz	Watt	Watt		WxDxH cm	WxDxH cm	kg
BBUCE		+2°+8°	-	220/50	407	345		66x42x30	70x45x50	20

## UNDERCOUNTER CABINETS



K150NTV





K250NTV





K350NTV

### CARATTERISTICHE - FEATURES - CARACTÉRISTIQUES

 Esterno in lamiera plastificata nera; Interno in lamiera plastificata grigia; Piedini regolabili; evaporazione automatica; Controllo elettronico; Serratura; Luce interna

 External in black plastic coated steel; Internal in grey plastic coated; adjustable feet; automatic evaporation of the water; electronic control; door lock; internal light











 Extérieur en tôle plastifiée noir, intérieur en tôle plastifiée grise, pieds réglables, évaporation automatique, contrôleur électronique, serrures, éclairage intérieur

 Aussen Kunststoffbeschichtetes schwarzes Stahlblech - Innen Kunststoffbeschichtetes graues Stahlblech - Höhenverstellbare Füße - Automatische Abtauung Elektronische Steuerung Türschloss - Innenlicht

 Externo en acero plastificado negro; interno en acero plastificado gris; soportes ajustables; evaporación automática; Control electrónico; Cerradura; Luz Interna

 Dış Gövde Kahverengi Plastik Kaplı Sac. İç Gövde Gri Plastik Kaplı Sac. Ayarlanabilir Ayaklar. Suyun Otomatik Evaporasyonu, Kapı Kilidi, İç Işık.

 Внешняя отделка из стали покрытой черным пластиком; внутренняя – сталь покрытая серым пластиком; регулируемые ножки, автоматическое испарение, электронный контроль, замок на двери, внутренняя подсветка

Modello Model Modell Modelo Model Модель	 Price	 Temperature	 Capacity	 Refrig. Power	 Voltage	 Abs. Power	 Dimensions	 Packing Dim.	 Shelves	 Ambient Temp.	 Weight
	€	°C	Lt	Watt	Volt/Hz	Watt	WxDxH cm	WxDxH cm	N°	°C	kg
K150NTV		+2° +12°	110	360	220-240/50	217	59,5X50X91	64X54X95	2	32	30
K250NTV		+2° +12°	210	380	220-240/50	260	92X50X91	97X54X95	4	32	42
K350NTV		+2° +12°	310	471	220-240/50	295	138X50X91	143X54X95	6	32	52



euro-MILAN  
DISTRIBUTING

115 Matheson Boulevard East, Mississauga, ON L4Z 1X8  
Toll Free 855.544.8600 info@euromilan.com  
euromilan.com or shopeuromilan.com



Il costruttore si riserva il diritto di apportare modifiche senza preavviso - We reserve the right to change specifications without notice - Nous réservons le droit de modifier nos produits sans préavis - Technische Änderungen vorbehalten - El constructor se reserva la facultad de aportar cambios sin aviso previo - Doğal olarak, ürünlerde yapılacak olası teknolojik yenilikler ve değişiklikleri haber vermeksizin yapma hakkımızı saklı tutmaktayız - Мы оставляем за собой право вносить изменения в спецификацию без дополнительного уведомления