

Vintage - Mobile Pozzetti

Date	_____
Project	_____
Location	_____

MODEL | ITEM CODE



Pozzetto Vintage is available in the following versions: 4, 6, 8 and 10 flavours, with or without transparent canopy. You can personalize the counter choosing any RAL lacquering colour, and complete it with the different lids offered by BRX .

Externally, a decoration inspired by the past and the elegance of classic

Vintage is in the sign of simplicity, easy to use, with the reliability of technologies coming from the systems for the professional ice-cream. Available both with glycol and ventilated refrigeration.

Lids offered

WOOD



PEACE

BAN

SOLID SURFACE



PEACE

BAN

METAL



TIT

BELL

STEEL



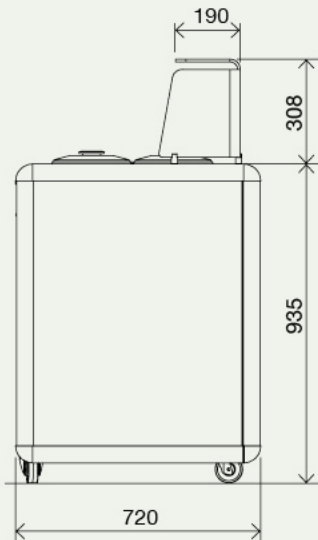

WITH STORAGE

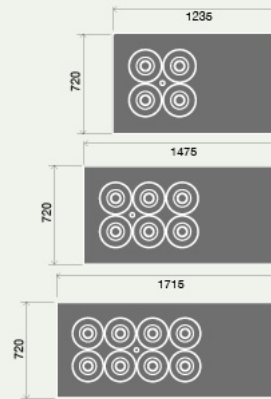

WITHOUT STORAGE

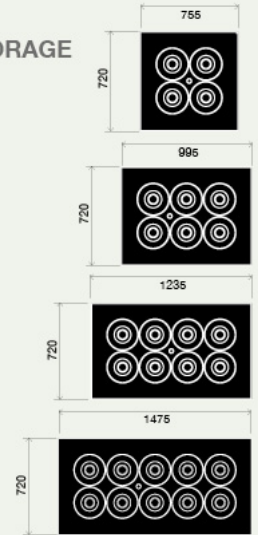

Model 4

115/1ph/60Hz
Refriger.Gas R404A
Cool.Cap W 325
Power Cons W 300

Model 6

115/1ph/60Hz
Refriger.Gas R404A
Cool.Cap W 325
Power Cons W 305

Model 8

115/1ph/60Hz
Refriger.Gas R404A
Cool.Cap W 555
Power Cons W 510

Model 10

115/1ph/60Hz
Refriger.Gas R404A
Cool.Cap W 555
Power Cons W 520

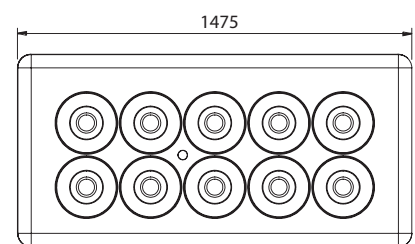
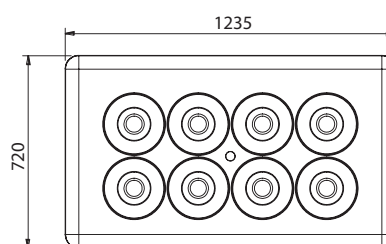
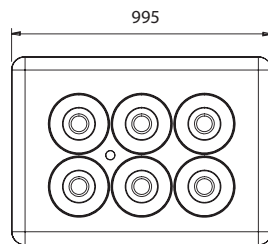
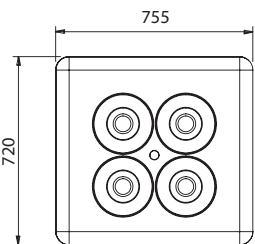

MODULES
AVAILABLE:
4, 6, 8, 10 flavours.
Glycol or ventilated.
With or without
transparent
canopy.

Euro-Milan reserves the right to modify the characteristics of the products illustrated in this publication without prior notice.
We accept no liability for misprints and other errors. There may be colour deviations due to the printing process.