







F351-C

Parts Diagram

2017 - 2024 Ford F250 - F350

With 6.2L, 6.8L, 7.3L Engine

Max : 176 - Inch Maximum Wheelbase

| Item | QTY | Part NO. | Descriptions | Length |
|------|-----|---------------|----------------------|---|
| 1 | 1 | MPI - 14 | Right Side Tail Pipe | 70.5 |
| 2 | 1 | MPI - 54 | Left Side Tail Pipe | 39 |
| 3 | 1 | MPI - 53 | Left Side Axle Pipe | 47 |
| 4 | 2 | MPI - 56 | Head Pipes | 60 |
| 5 | 1 | MPI - PC12 | Pulse Chamber | - |
| 6 | 2 | MPI - SC275 | 2 3/4" Clamp - std. | - |
| 7 | 5 | MPI - SC250 | 2 1/2" Clamp - std. | - |
| 8 | 2 | MPI - BCSS250 | 2 1/2" Band Clamp | - |
| 10 | 1 | Hanger - 29 | Right Hand Tail |  |
| 11 | 1 | Hanger - 26 | Head Pipe |  |
| 12 | 1 | Hanger - 27 | Right Hand Muffler |  |
| 13 | 1 | Hanger - 28 | Left Hand Muffler |  |
| 14 | 1 | Hanger - 30 | Left Tail Pipe |  |
| 15 | 2 | - | Muffler | 14" |
| 16 | 2 | 2535 | Tips | 12" |
| 17 | 2 | MPI-Wire tie | Wire tie | 9" |
| 18 | 1 | MPI - 3/8-1.5 | Bolt - H02 | 1 1/2" |
| 19 | 1 | MPI-HD-003 | LR Hanger Block | |

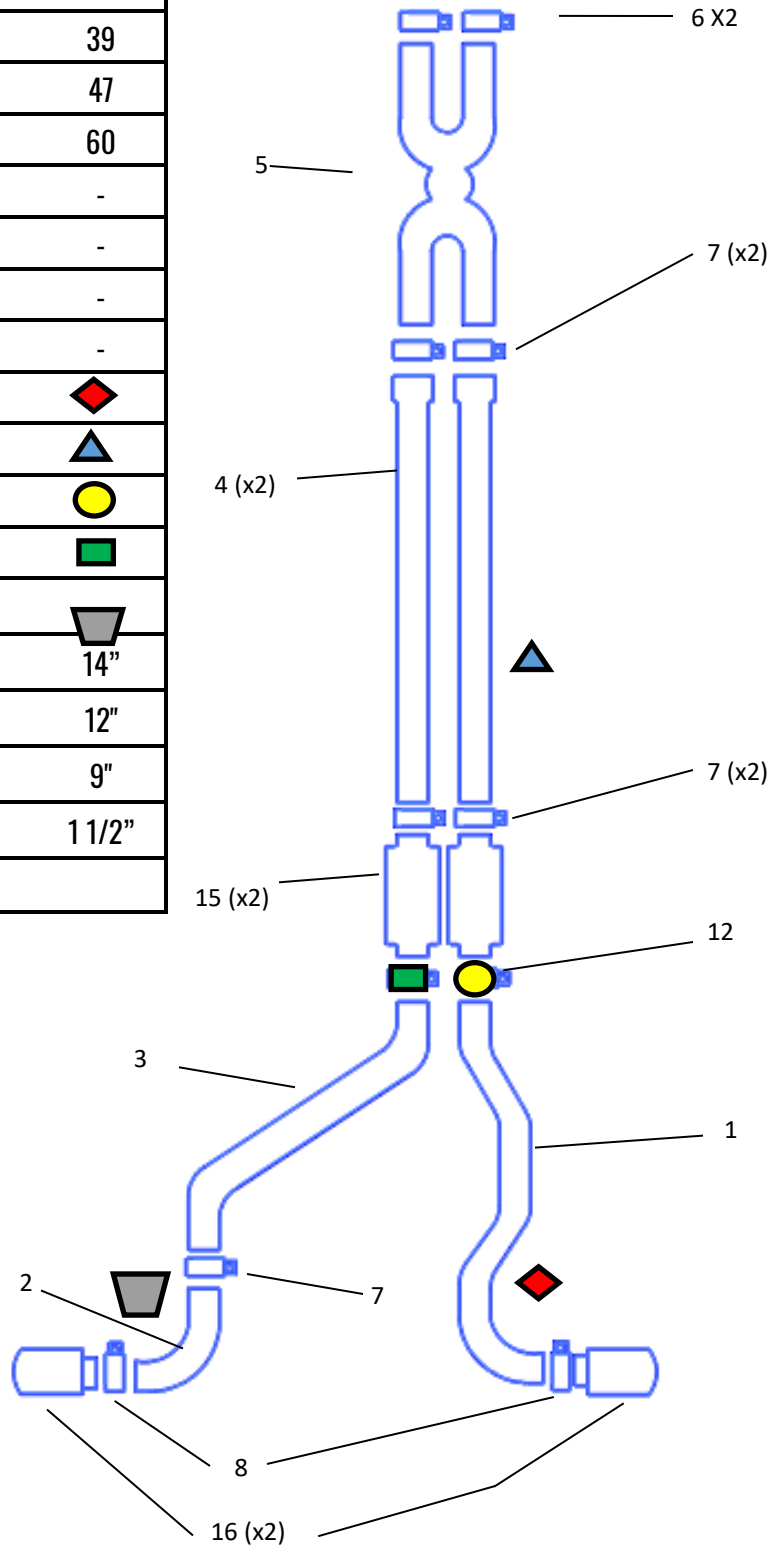







F352-C

Parts Diagram

2017 - 2024 Ford F250 - F350
 With 6.2L, 6.8L, 7.3L Engine
 Max : 176 - Inch Maximum Wheelbase

| Item | QTY | Part NO. | Descriptions | Length |
|------|-----|---------------|----------------------|---|
| 1 | 1 | MPI - 15 | Right Side Tail Pipe | 77.5 |
| 2 | 1 | MPI - 55 | Left Side Tail Pipe | 49 |
| 3 | 1 | MPI - 53 | Left Side Axle Pipe | 47 |
| 4 | 2 | MPI - 56 | Head Pipes | 60 |
| 5 | 1 | MPI - PC12 | Pulse Chamber | - |
| 6 | 2 | MPI - SC275 | 2 3/4" Clamp - std. | - |
| 7 | 5 | MPI - SC250 | 2 1/2" Clamp - std. | - |
| 8 | 2 | MPI - BCSS250 | 2 1/2" Band Clamp | - |
| 10 | 1 | Hanger - 29 | Right Hand Tail |  |
| 11 | 1 | Hanger - 26 | Head Pipe |  |
| 12 | 1 | Hanger - 27 | Right Hand Muffler |  |
| 13 | 1 | Hanger - 28 | Left Hand Muffler |  |
| 14 | 1 | Hanger - 30 | Left Tail Pipe |  |
| 15 | 2 | - | Muffler | 14" |
| 16 | 2 | 2535 | Tips | 12" |
| 17 | 2 | MPI-Wire tie | Wire tie | 9" |
| 18 | 1 | MPI - 3/8-1.5 | Bolt - H02 | 1 1/2" |
| 19 | 1 | MPI-HD-003 | LR Hanger Block | |

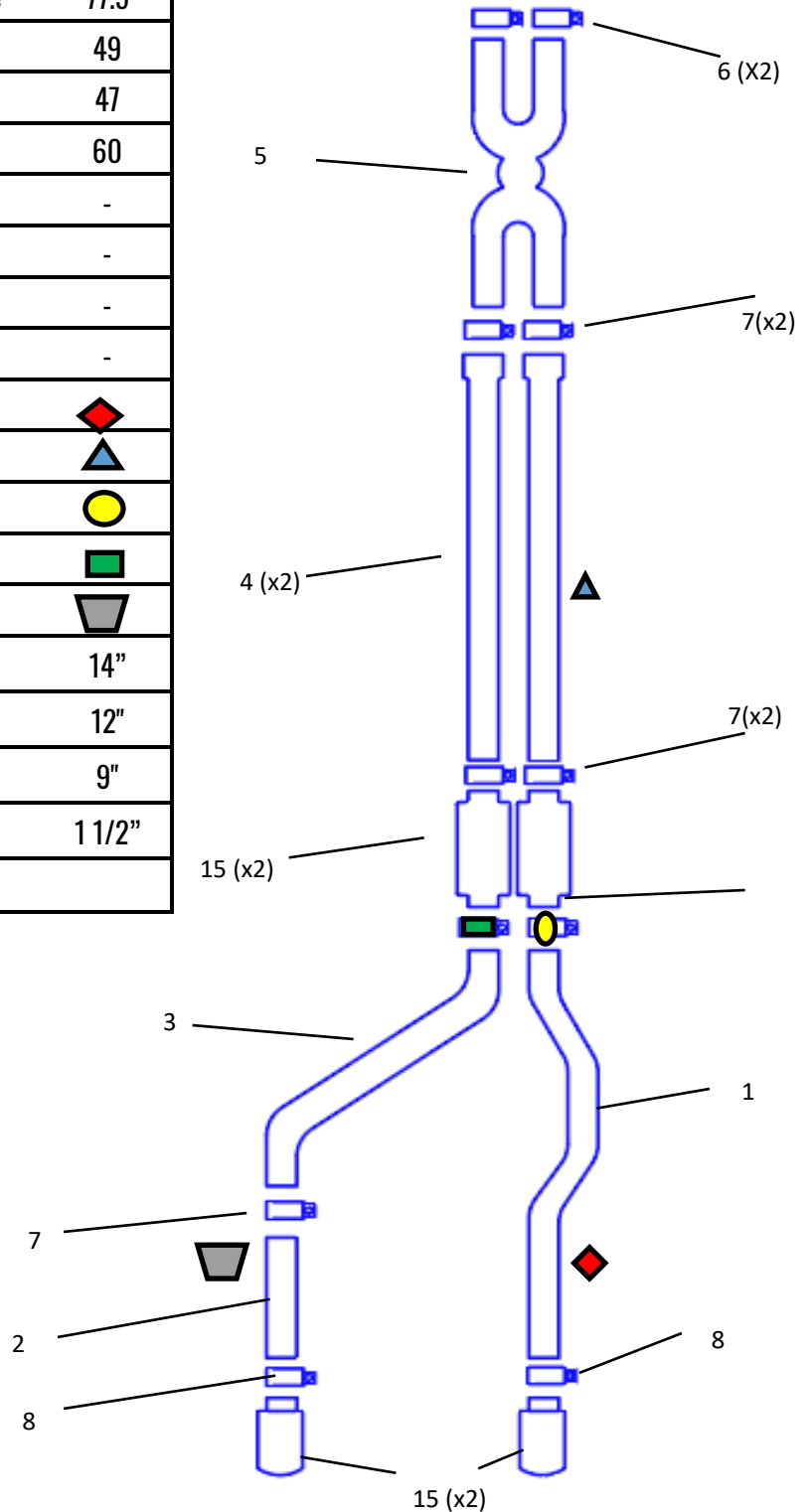

Customer Support And Warranty information



Thank you for purchasing a MPI Exhaust Technologies System and letting MPI Exhaust customize your ride today! We have a friendly and knowledge staff so contact us with any questions. Enjoy the Sound of Perfection

Questions -

ONLY contact MPI Exhaust Technologies if any products are possibly missing, damaged, during shipping or if you have any question about the products.

Call @ 406-669-3286

Installation -

Watch the tutorial YouTube videos before installation or calling @mpi exhaust, we have a very knowledgeable staff that has installed hundreds of these kits.

Warranty -

Contact

Phone - (406) 669-3286

Email : mikespipesinc@gmail.com



1. Remove Factory System - Cut In front of dual in single out resonator as close to the case welds as possible on the inlet side
2. Slide Pulse chamber over Factory pipe then Clamp Pulse Chamber , ensure offset away from driveshaft and leveling for Best
3. Install the Right side Head Pipe, then trim to Wheelbase (view diagram) Snug Clamps as you go, don't final tighten yet
4. Install Muffler assembly , Ensure Rear Muffler Measurement is correct to ensure proper tailpipe placement with Offset Toward Front
5. Use Rear muffler Hanger to hold assembly in place while measure or tightening
6. Install Hanger Head Pipe Hanger—Final tighten all clamp to this Point
7. Install RR Tail Pipe Level, then clamp
8. Install RR hanger then install Tips check to ensure level and placement,
9. Use MPI-Wire tie to secure brake lines and Breather lines together
10. Install Axle Pipe & LR tail Pipe, Ensure proper Clearance for Spare tire and rear end Travel
11. Install LR hanger— Use bolt MPI - 3/8-1.5 to bolt through chassis
12. Install LR tip, Check level and positions to match RR
13. Clean finger prints off tips with glass cleaner, clean pipes with brake clean, Paint Added Hanger Black on Chassis

2017 - 2024 Ford F250 - F350
With 6.2L, 6.8L, 7.3L Engine
Max : 176 - Inch Maximum Wheelbase

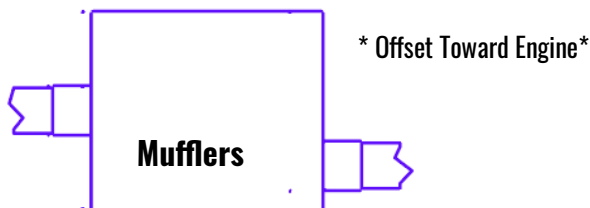
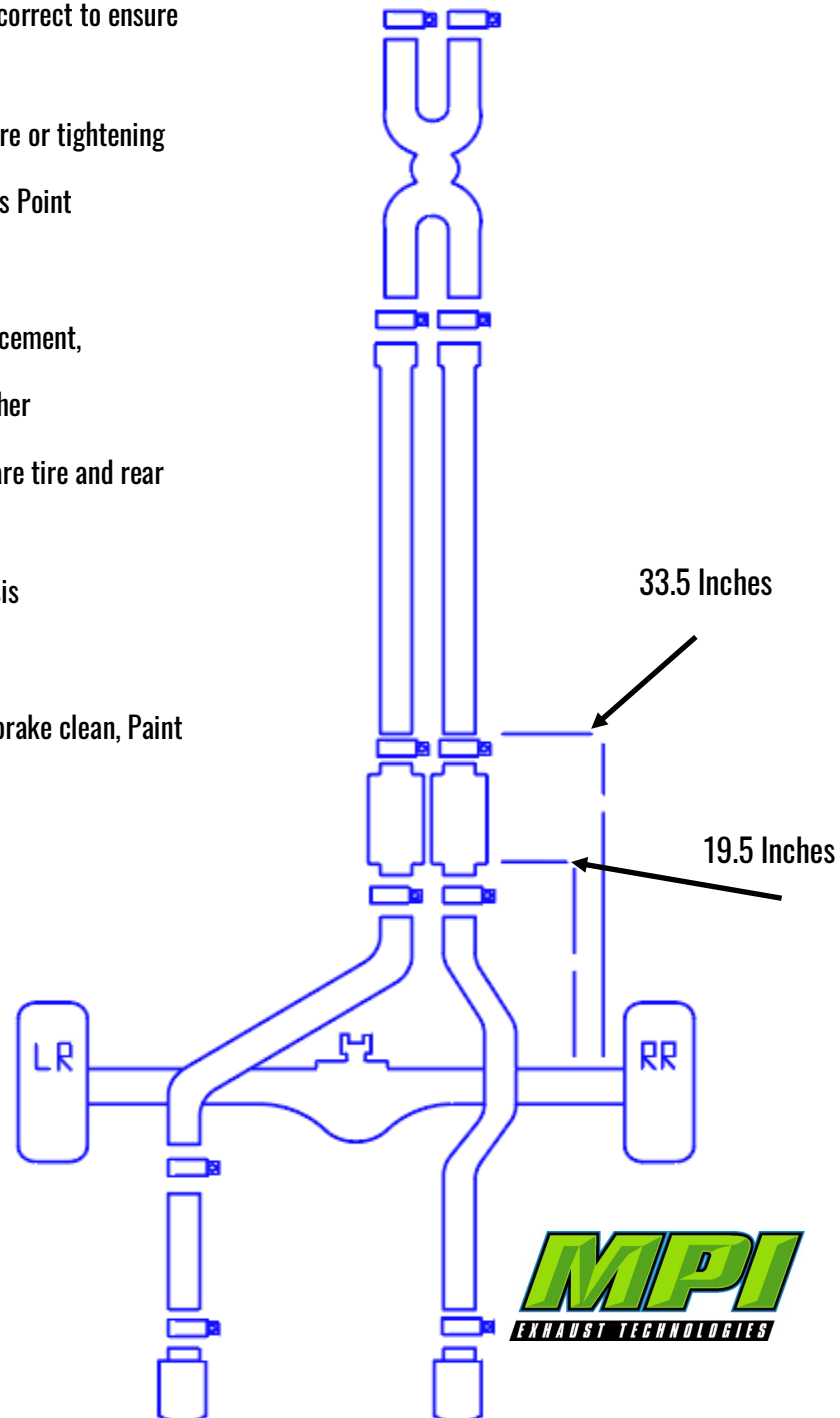

F 351-C & F352-C

Instructions Packet

2017 - 2024 Ford F250 - F350

With 6.2L, 6.8L, 7.3L Engine

Max : 176 - Inch Maximum Wheelbase

F3-12



MPI
EXHAUST TECHNOLOGIES