







D422-C

Parts Diagram

2019 - 2024 Ram 1500 -
(NON-Classic)

With 5.7L Hemi Engine

Max : Wheelbase

Item	QTY	Part NO.	Descriptions	Length
1	1	MPI - 25	Right Side Tail Pipe	
2	1	MPI - 88	Left Side Tail Pipe	
3	1	MPI - 87	Left Side Axle Pipe	
4	2	MPI - 0—60	Head Pipes	
5	1	MPI - PC2	Pulse Chamber	-
6	1	MPI - SC30	3" Clamp - std.	-
7	5	MPI - SC225	2 1/4" Clamp - std.	-
8	2	MPI - BCSS225	2 1/4" Band Clamp	-
10	1	Hanger - 49	Head Pipe	
11	1	Hanger - 50	RH Muffler Hanger	
12	1	Hanger - 51	LH Muffler Hanger	
13	1	Hanger - 52	RR Tail Pipe	
15	1	Hanger—53	LR Tail Pipe	
16	2	-	Mufflers	14"
17	2	2435	Tips	12"
18	2	MPI-Wire tie	Wire tie	9"

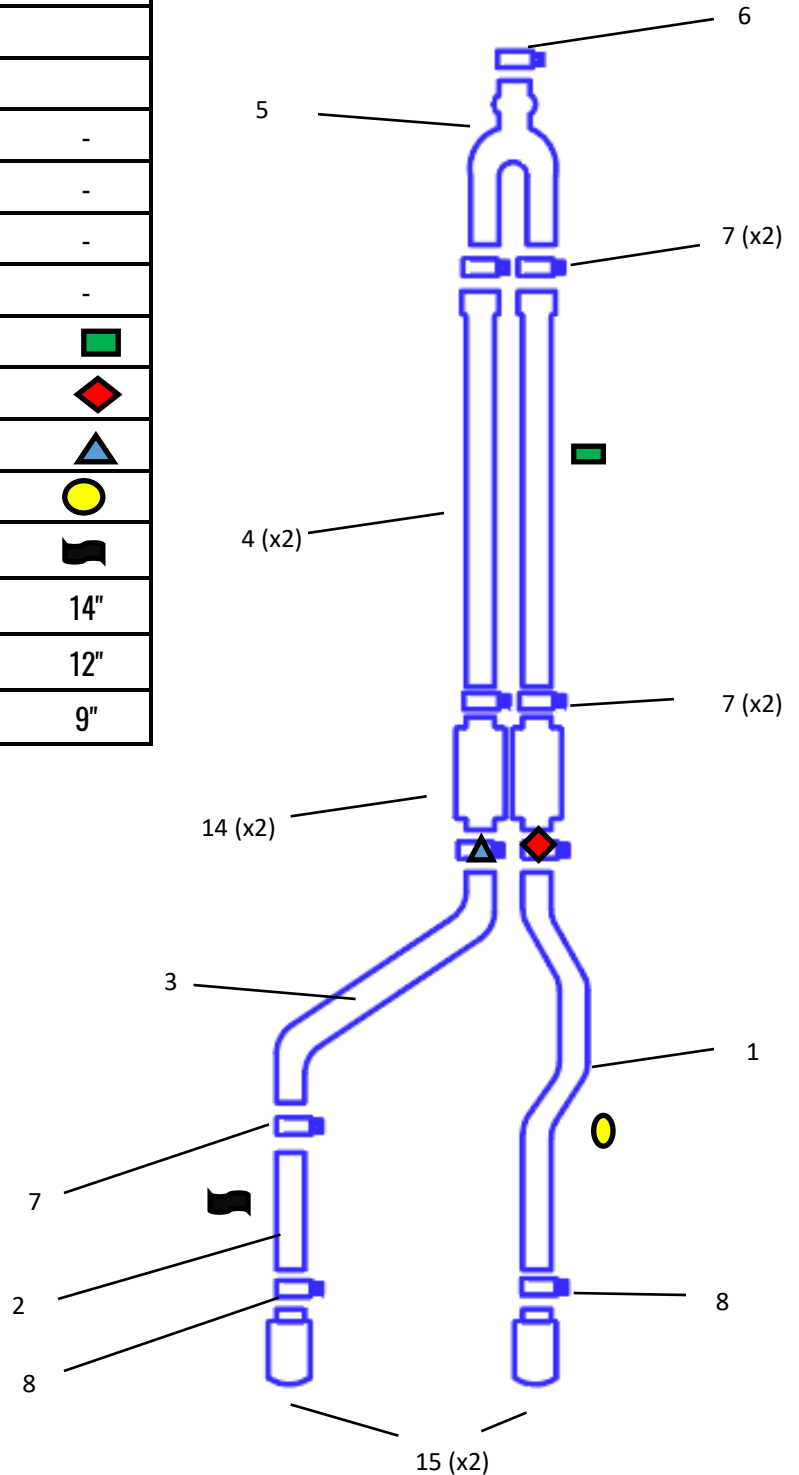

Customer Support And Warranty information



Thank you for purchasing a MPI Exhaust Technologies System and letting MPI Exhaust customize your ride today! We have a friendly and knowledgeable staff so contact us with any questions. Enjoy the Sound of Perfection

Questions -

ONLY contact MPI Exhaust Technologies if any products are possibly missing, damaged, during shipping or if you have any question about the products.

Call @ 406-669-3286

Installation -

Watch the tutorial YouTube videos before installation or calling @mpi exhaust, we have a very knowledgeable staff that has installed hundreds of these kits.

Warranty -



Contact

Phone - (406) 669-3286

Email : mikespipesinc@gmail.com



Instruction

2019 - 2024 Ram 1500 - (NON-Classic)

With 5.7L Hemi Engine

Max : Wheelbase

1. Remove Factory tailpipes, leave ground strap hooked to chassis, then remove factory (upside down) clamp where factory becomes single 3 pipe
2. Slide Pulse chamber over Factory pipe then Clamp Pulse Chamber
3. Install the Right side Head Pipe, Offset towards Front and downward - then trim to Wheelbase (view diagram) Snug Clamps as you go, don't final tighten yet
4. Install Right side muffler. Ensure Rear Muffler Measurement is correct to ensure proper tailpipe placement with Offset Toward Front
5. Install Hanger Head Pipe Hanger—Final tighten all clamp to this Point
6. Install RR Tail Pipe Level, then clamp
7. Install RR hanger then install Tips check to ensure level and placement,
8. Use MPI-Wire tie to secure brake lines and Breather lines together (BehindTire Rams only)
9. Install Axle Pipe & LR tail Pipe, Ensure proper Clearance for Spare tire and rear end Travel
10. Install LR hanger- (Use bolt MPI - 3/8-1.5 on BT style Rams)
11. Install LR tip, Check level and positions to match RR
12. Install Factory Ground strap to RR Muffler Hanger
13. Clean finger prints off tips with glass cleaner, clean pipes with brake clean,

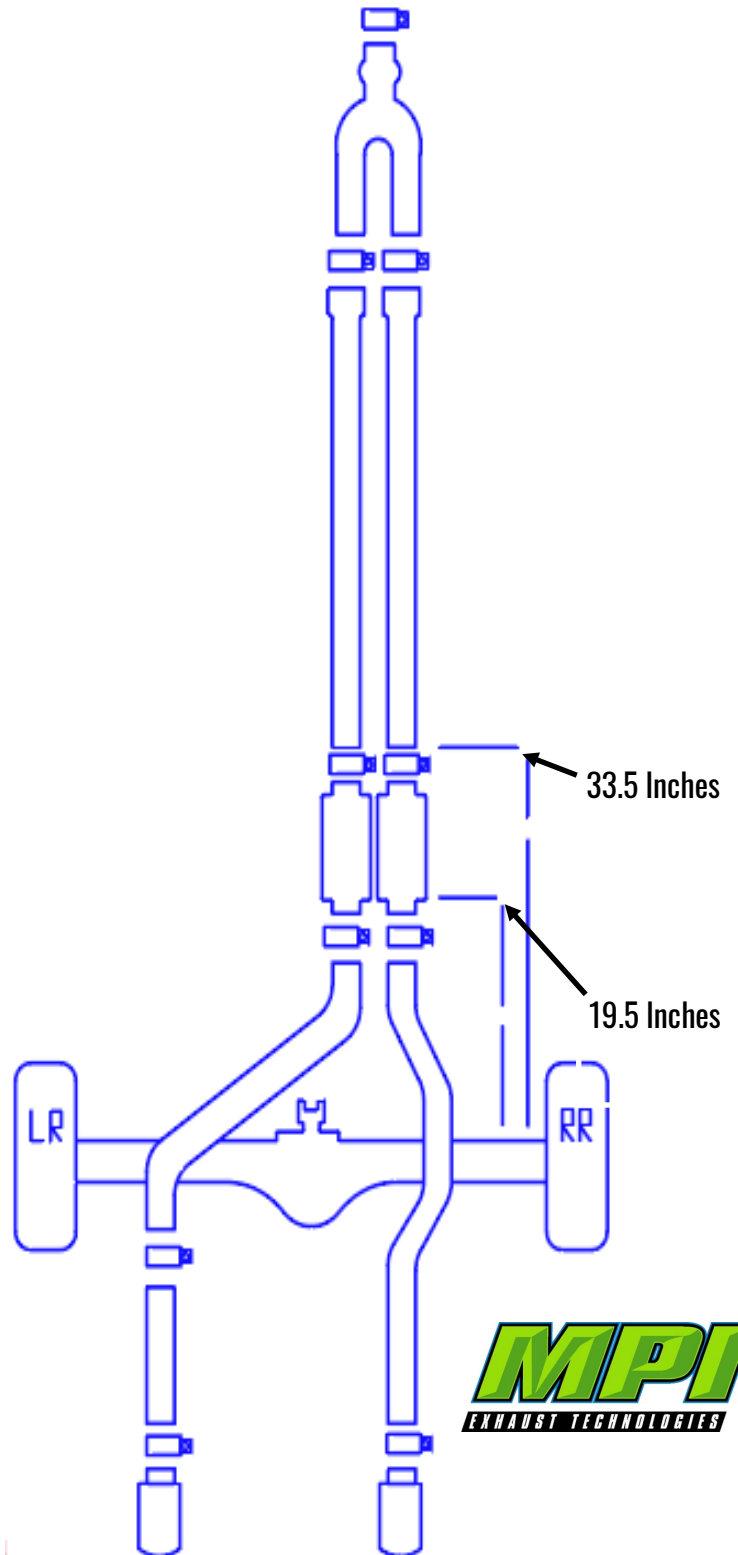

D422-C

Instruction Packet

2019 - 2024 Ram 1500 - (NON-Classic)

With 5.7L Hemi Engine

Max : Wheelbase

D4-2



MPI
EXHAUST TECHNOLOGIES