

Quick start installation guide



Zip HydroTap G5

Command Centre
Boiling, Chilled & Sparkling models



AFFIX PRODUCT LABEL HERE



UK

Visit our website to
download the manuals

Table of contents

| | |
|--|----|
| SECTION 1: Using these instructions | 3 |
| SECTION 2: IMPORTANT SAFETY INSTRUCTIONS..... | 4 |
| SECTION 3: WARNINGS & REGULATORY INFORMATION..... | 6 |
| SECTION 4: Technical data | 8 |
| SECTION 5: Parts supplied, consumables and accessories | 10 |
| SECTION 6: Set up the ventilation | 11 |
| SECTION 7: Fit the carbonation valve | 14 |
| SECTION 8: Connect the water supply..... | 15 |
| SECTION 9: Set the bypass & install the limescale filter | 16 |
| SECTION 10: Fit the booster | 17 |
| SECTION 11: Connect the Booster | 18 |
| SECTION 12: Install the CO ₂ cylinder and regulator | 19 |
| SECTION 13: Connect the Command Centre | 24 |
| SECTION 14: Commissioning..... | 27 |

SECTION 1: Using these instructions

Before you start



This document is a Quick Start Installation Guide.
For further details on installing and operating your HydroTap download & read the Command Centre installation and user instructions , which can be found online at:

(Australia) www.zipwater.com

(UK) specify.zipwater.co.uk



Read and use the instructions supplied with individual kit components for a safe installation.

Explanation of symbols



Read the
instructions



WARNING



Danger of
electric shock



Hot surface



Highly
flammable



CO₂ Gas
WARNING

SECTION 2: IMPORTANT SAFETY INSTRUCTIONS

Compliance



In Australia electrical installation must comply with AS/NZS3000.

In Australia plumbing installation must comply with AS/NZS3500.

In Australia For residential chilled models, all refrigeration must comply with AS/NZS 60335.2.24.

In the UK the system must be installed in accordance with water supply byelaws, current IEE regulations and local authority byelaws.

Safety

This appliance is not intended for use by children under 8 years or persons (including children under 8 years) with reduced physical, sensory or mental capabilities, or lack of experience and knowledge, unless they have been given supervision or instruction concerning the use of the appliance by a person responsible for their safety. Children should be supervised to ensure that they do not play with the appliance.

Refrigerant

WARNING! KEEP VENTILATION OPENINGS IN THE APPLIANCE ENCLOSURE OR IN THE BUILT-IN STRUCTURE CLEAR OF OBSTRUCTION.



The Zip HydroTap Command Centre range uses either HIGHLY FLAMMABLE R290, R600a or R134A refrigerant under pressure.

Check the rating plate or contact Zip before commencing work.

Maintenance of the refrigeration unit must be carried out by an accredited service provider or qualified refrigeration technician.

Do not use mechanical devices or other means to accelerate the defrosting process, other than those recommended by the manufacturer.

Do not store explosive substances such as aerosol cans with a flammable propellant in this appliance.

CO₂

- Keep out of reach of children.
- Use according to MSDS (material safety data sheet).
- Pressurised container. Contains gas under pressure, may



SECTION 2: IMPORTANT SAFETY INSTRUCTIONS

explode if heated.

- Protect from sunlight.
- Do not expose to temperatures exceeding 50 °C.
- Do not expose to naked flame or any incandescent material.
- Do not pierce or burn, even after use. Avoid shock.
- High concentration of gas may cause asphyxiation.
- Use only in an upright position.
- The cylinder must be used with the supplied pressure regulator.
- The gas cylinder must be installed in an open plan area, or in an enclosed room with a volume no less than 20m³ per 1200g cylinder, or 50m³ per 2640g cylinder.
- If more than 1 gas cylinder containing CO₂ is present within the same location, the recommended ventilated area should be in proportion to the number of gas cylinders stored in that location. A ventilated area is a non-enclosed area which could include the kitchen, living room etc.
- Refer to the gas cylinder and MSDS for a complete list of warnings (www.zipwater.com, www.zipwater.co.uk).

Qualifications

To avoid hazards, all installation procedures must be carried out by a suitably qualified tradesperson. The power cable and power outlet must be in a safe visible position for connection.

Venting

Sometimes steam and / or boiling water droplets may discharge through a vent outlet on the tap. If not using the font, ensure the tap body is located so the tap outlet safely dispenses into the sink bowl.

Lifting

Take care when lifting. The Command Centre may exceed safe lifting limits. If you feel this is beyond your personal capabilities, please seek assistance with the lift. The weight of the Command Centre is marked on the packaging. Do not lift the Command Centre by the front cover or any of its connections.

Airflow

The Zip HydroTap operates within the ambient temperature range 5°C - 35°C. Proper air circulation must be provided. The system will operate satisfactorily only if the recommended air gaps are provided. The vent kit supplied must be fitted.

SECTION 2: IMPORTANT SAFETY INSTRUCTIONS

Altitude

Water boils at varying temperatures at different altitudes. The HydroTap adjusts for this during startup calibration and will recalibrate itself on a regular basis.

Frost protection

If the HydroTap is located where the ambient air temperature could fall below 5°C when the system is not in use, do not turn off the Command Centre electrically. This safeguard does not offer the same protection to the connecting pipework and fittings.

Application

The HydroTap G5 Home series is intended to be used in household and similar applications such as:

- Staff kitchen areas in shops, offices and other working environments;
- Farm houses and by clients in hotels, motels and other residential type environments;
- Bed and breakfast type environments;
- Catering and similar non-retail applications.

SECTION 3: WARNINGS & REGULATORY INFORMATION



- For continued safety of this appliance it must be installed, operated and maintained in accordance with the manufacturer's instructions.
- This appliance may deliver water at high temperature. Refer to the Plumbing Code of Australia (PCA), local requirements and installation instructions to determine if additional delivery temperature control is required.



-  The Zip HydroTap must be earthed. Earthing is provided via the supplied power cord. The resistance of the earth connection to each exposed metal part must be less than 1Ω. Use the power cable supplied. It is the responsibility of the installer to ensure the power point is earthed.
- All installation and service work must be completed by trained and suitably qualified tradespeople. Faulty operation due to unqualified persons working on this product may void warranty coverage.

SECTION 3: WARNINGS & REGULATORY INFORMATION

- As the installer, it is your responsibility to supply and install all valves as required by local regulations and relevant standards.
- The HydroTap is rated for 220-240V 50Hz AC operation.
- Do not remove the cover of the appliance under any circumstances without first isolating the appliance from the power supply.
- Connect only to a potable (wholesome, cat1) mains water supply.
- The new hose sets supplied with the product must be used. Do not re-use old hose sets.
- Never locate the system near, or clean with water jets.
- Do not expose the Zip HydroTap to the elements of nature.
- The booster complies with protection class IP 20.
- For UK, a pressure limiting valve must be fitted for mains water pressures above the maximum limits stated.
- Use of tools can be hazardous. Assess the risks before you start.
- A clearance envelope around all Command Centres must be provided to allow adequate ventilation for the safe and effective use of the HydroTap system.
- The vent tray, if provided, must be fitted. It provides a safe exhaust for refrigerant gas in the unlikely event of a leak.
- Valve and fitting threads must be sealed appropriately with PTFE tape where compression seals are not provided.
- Always flush new filter before use.
- Do not connect booster to electrical supply until commissioning.
- Do not over tighten plumbing and hose connections.
- Braided hoses supplied cannot be lengthened.
- Be aware of the risks of hazards which could cause harm when handling compressed CO₂. Assess the risks before starting the installation.
- Do not proceed with a CO₂ cylinder change if the seals are damaged. Take care not to cross thread the regulator, a cross threaded regulator poses a potential hazard.
- Care must be taken when working with high pressure carbon dioxide, and in no case should the normal operating pressure of 3.0 bar be exceeded.
- The power cord and general power outlet must be in a safe and accessible position after installation. When positioning the appliance, ensure the power supply cord is not trapped or damaged. If the power supply cord is damaged it must be replaced by a Zip service provider or a qualified electrician.

SECTION 3: WARNINGS & REGULATORY INFORMATION

- Do not locate multiple portable socket-outlets or portable power supplies at the rear of the appliance.
- For safe operation, the HydroTap is designed to be installed, commissioned and used within 48 hours. Should the HydroTap not be required for an extended period of time (72 hours or more), do not fill and commission the HydroTap until ready for first use.
- For water taste and quality reasons, following any non-use period of more than 72 hours, Zip recommends to perform a system flush. Failure to flush the system may affect water quality.
- For UK, this appliance incorporates adequate backflow prevention in accordance to S.I.1999 No.1148 The Water Supply (Water fittings) Regulations 1999 Schedule 2 requirement. No further backflow prevention is required for connection to the water supply.
- For UK, this appliance only contains materials that conform to the requirements of BS6920:2014 'Suitability of non metallic materials and products for use in contact with water intended for human consumption with regard to their effect on the quality of water'.

SECTION 4: Technical data

| Model | Power rating, kW | Dimensions | Weight |
|------------------------|------------------|---|--------|
| | 220-240V, 50Hz | W x D x H (mm) | (kg) |
| BCS100 BCS100 H | 2.15 + Booster | 395 x 464 x 333 With Duct and Vent Tray: 450 (500) [#] x 464 (520) [#] x 333 (373) [#] | 41 |
| BCS60 BCS60 H | 2.15 | 395 x 464 x 333 With Duct and Vent Tray: 450 (500) [#] x 464 (520) [#] x 333 (373) [#] | 41 |
| BCS30 BCS30 H | 1.96 + Booster | 339 x 483 x 333 | 34 |
| BCS20 BCS20 H | 1.96 | 339 x 483 x 333 | 34 |
| BCS Home BCS H Home | 1.53 | 339 x 483 x 333 | 34 |

[#]Including vent tray, absolute min. vent tray depth 490mm (limit of travel, may affect airflow).

SECTION 4: Technical data

Electricity supply requirements

220-240V 50Hz AC (for power requirement see table above).

| | Without booster | With booster |
|-----------|-----------------------------|------------------------------|
| Australia | 1x 220 - 240V AC 10A socket | 2x 220 - 240V AC 10A sockets |
| UK | 1x 220 - 240V AC 13A socket | 2x 220 - 240V AC 13A sockets |

Water supply connection

1/2" BSP (G1/2)

Water supply pressure requirements

| Component | Min - Max pressure, kPA (bar) | |
|--------------------|-------------------------------|-----------------------|
| | Australia | UK |
| HydroTap | 170 (1.7) - 700 (7.0) | 170 (1.7) - 500 (5.0) |
| Sparkling HydroTap | 250 (2.5) - 700 (7.0) | 250 (2.5) - 500 (5.0) |
| Vented Mixer Tap | 300 (3.0) - 700 (7.0) | 200 (2.0) - 500 (5.0) |
| Booster | 200 (2.0) - 700 (7.0) | 200 (2.0) - 500 (5.0) |
| Limescale filter | 200 (2.0) - 700 (7.0) | 200 (2.0) - 500 (5.0) |



A pressure limiting valve must be fitted for mains water pressures above the maximum limits stated above in accordance with local plumbing regulations.

Note: All models (excluding UK) have an internal pressure limiting device to reduce the maximum mains regulated pressure (700kPa in Australia), protecting the system against pressure surges above 500kPa.

Booster specification

| Specification | Rating |
|--------------------|-----------|
| Power 230V 50/60Hz | 2.20kW |
| Power 240V 50/60Hz | 2.40kW |
| Flow rate | 1.2 L/min |

SECTION 5: Parts supplied, consumables and accessories

| Parts supplied with the HydroTap | BCS for Work | BCS H for Work | BCS for Home | BCS H for Home |
|---|-----------------|-------------------|-----------------|-------------------|
| Tap | | | | |
| HydroTap tap | | ✓ | | ✓ |
| HydroTap pipes, tubes hoses and fittings | | ✓ | | ✓ |
| Separate vented Mixer tap | ✗ | ✓ | ✗ | ✓ |
| Vented Mixer tap hoses and fittings | ✗ | ✓ | ✗ | ✓ |
| Vented Mixer tap instructions | ✗ | ✓ | ✗ | ✓ |
| Separate Mains mixer Tap | Optional | | Optional | |
| Separate Mains mixer Tap fittings | Optional | | Optional | |
| Separate Mains mixer Tap instructions | Optional | | Optional | |
| Command Centre | | | | |
| Command Centre | | ✓ | | ✓ |
| Mains electrical supply cable | | ✓ | | ✓ |
| Water supply inlet hose | | ✓ | | ✓ |
| Water supply inlet adaptor and strainer | | ✓ | | ✓ |
| Ventilation kit (including vent tray with BCS60, BCS100 models) | | ✓ | | ✓ |
| Water block kit | (UK only) | | (UK only) | |
| CO₂ | | | | |
| CO ₂ cylinder | | ✓ | | ✓ |
| CO ₂ regulator | | ✓ | | ✓ |
| CO ₂ regulator adaptor* | (UK only) | | | ✓ |
| CO ₂ hose & instructions | | ✓ | | ✓ |
| Booster | | | | |
| Booster & hoses | Optional | | ✗ | |
| Filters | | | | |
| Water filter & instructions | | ✓ | | ✓ |
| Limescale filter kit | Optional | | Optional | |
| Font | | | | |
| Font kit | Optional | | Optional | |

* supplied with 1.2kg cylinder and adjustable regulator combination.

Note: Mains water isolation valve is not supplied with the kit.
Contact Zip for the full range of consumables and accessories.

SECTION 6: Set up the ventilation



Use of tools can be hazardous. Assess the risks before you start.



Use instructions supplied with individual kit parts.



A clearance envelope around the Command Centre must be provided to allow ventilation for the safe and effective use of the HydroTap system.

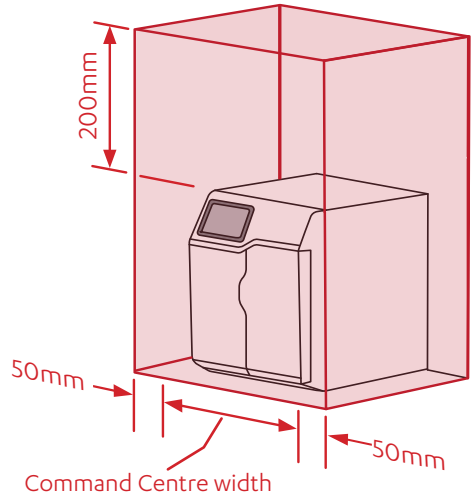

BCS HydroTap is supplied with either of two ventilation systems. Follow the instructions to suit your model.

Front vent

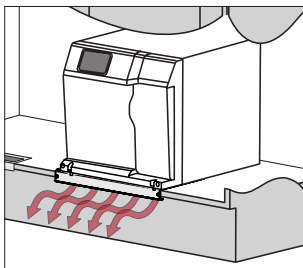

Side vent & tray

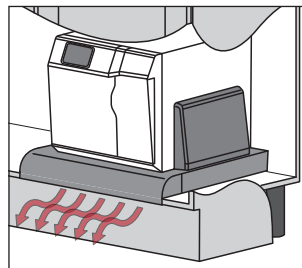

All models

If cupboard temperature exceeds 35°C, additional ventilation is required. Contact your Zip service provider for options (including additional vents and fan kit).

SECTION 6: Set up the ventilation

Models with front vent

- Cold air is drawn in through the inlet vent and gap provided by the door buffers. The inlet vent is positioned in the cupboard side, door or floor.
- Warm air is exhausted through the base of the Command Centre, through the cupboard floor cut-out.
- Observe 100mm inlet / outlet vent separation.



The cupboard exhaust must be cut out. It provides a safe exhaust for refrigerant gas in the unlikely event of a leak.

- a** Air inlet cut-out options (refer to the instructions provided with the vent grilles)

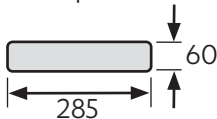

- b**
-

- c** Air exhaust vent cut-out.
Check size relative to your product.
For Command Centre width 339mm

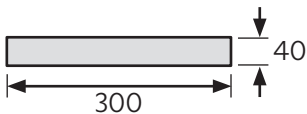

Align the mounting plate to the edge of the cupboard floor, and secure with the 4 self-tapping screws supplied.

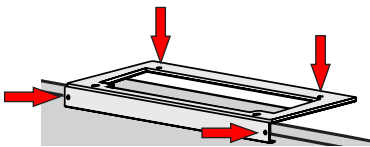

Then, secure Command Centre to mounting plate with 2 screws supplied.

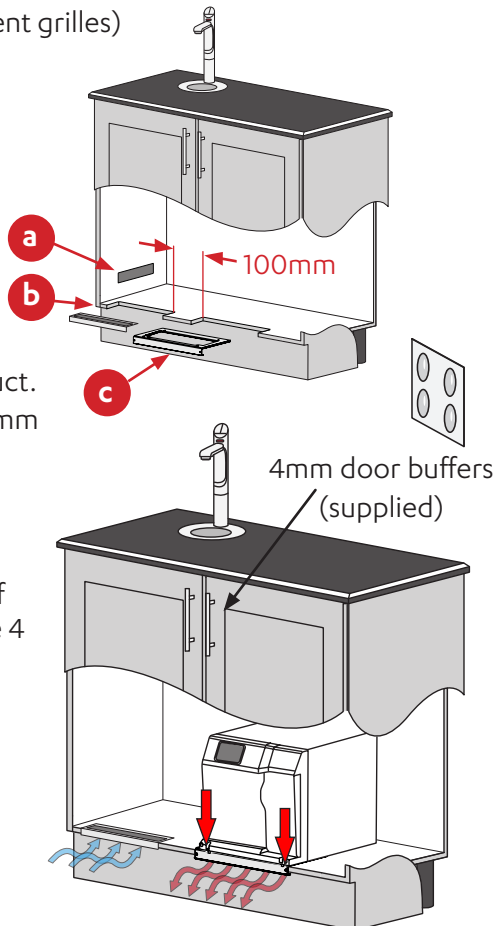

SECTION 6: Set up the ventilation

Models with side vent and tray

- Refer to the instructions provided with the Vent Tray.
- Cold air is drawn in through the inlet vent and gap provided by the door buffers.
- Inlet vent is mounted over cupboard side, door or floor cut-out.
- Warm air is exhausted through vent tray.
- Observe 100mm inlet / outlet vent separation.



The supplied vent tray must be fitted. It provides a safe exhaust for refrigerant gas in the unlikely event of a leak.

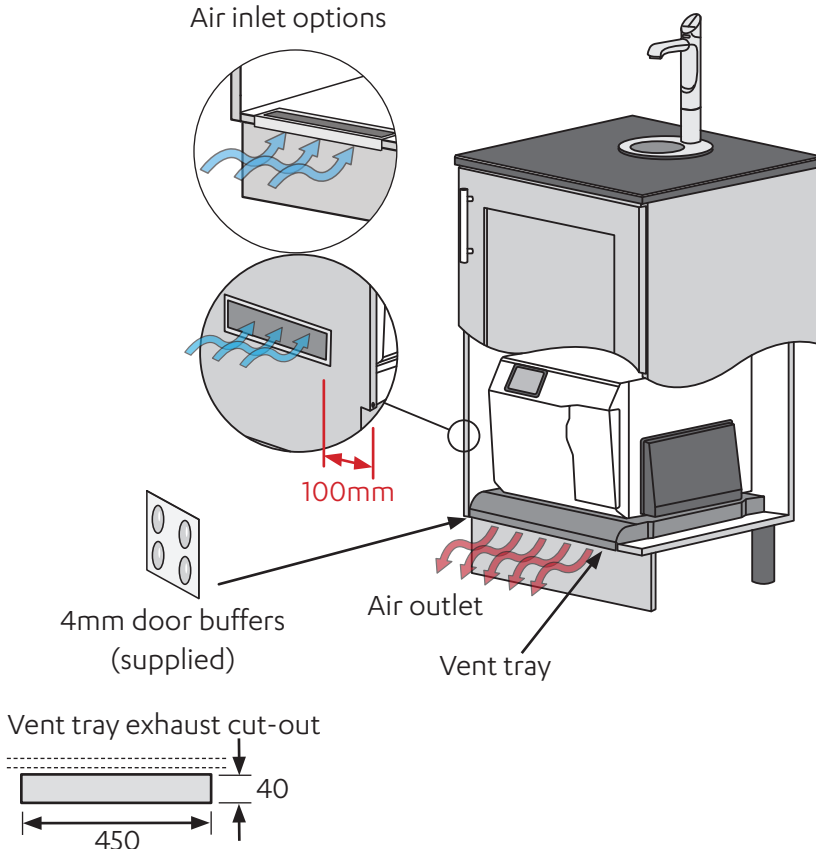

Vent tray dimensions WxDxH (mm): 500 x (515-555) x 40

Absolute min. vent tray depth 490mm (limit of travel, may affect airflow).

SECTION 7: Fit the carbonation valve

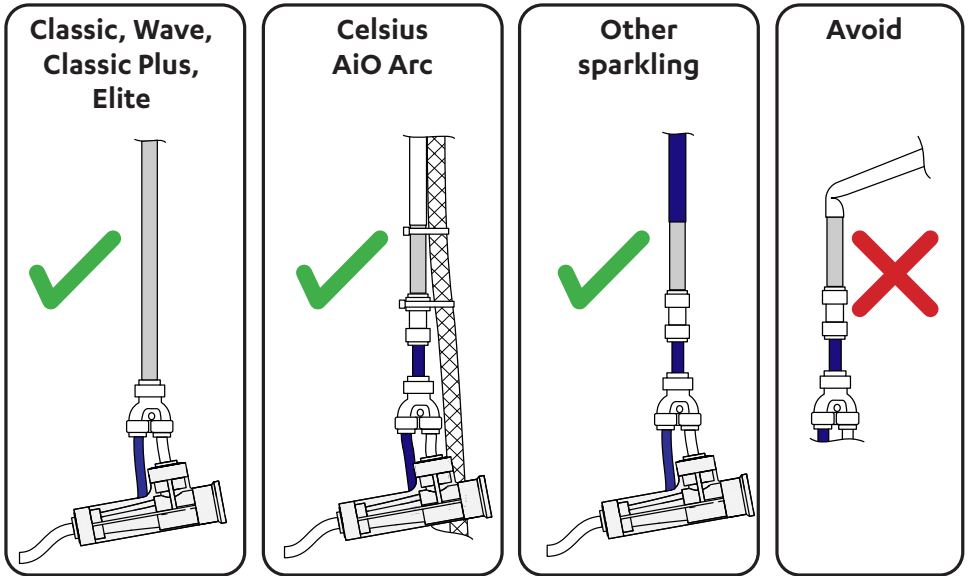

White tube to SPARKLING outlet
of Command Centre

Carbonation valve flow adjustment

- Use a 6mm Allen key or a large flat-blade screwdriver to adjust the valve.
- Rotate the adjustment screw anti-clockwise to increase, and clockwise to decrease the flow.
- To measure the set flow rate, use a measuring jug or cup and run the sparkling water for 15 seconds. The HydroTap has a default 15 second dispense time, which will help in your flow rate setup.
- Multiply the amount of water dispensed in 15 seconds by 4 to determine the flow rate in litres per minute.
- The optimum flow rate is 1.6 litres per minute (400ml per 15 seconds).
- If the flow rate is adjusted too high, the carbonation tank will be emptied of water, leaving only CO₂ to be dispensed from the tap. This will result in inconsistent flow (spluttering).

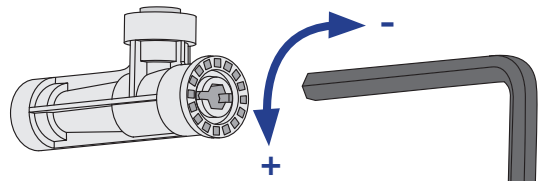

SECTION 8: Connect the water supply



Valves and fittings must be sealed with PTFE tape if compression seals are not included.

Note Mixer tap installations also use a 'tee piece' as part of the water supply plumbing connections, see the Tap installation instructions supplied with the Mixer Tap to connect the water supply if using the mixer tap option.

Note: correct strainer orientation.

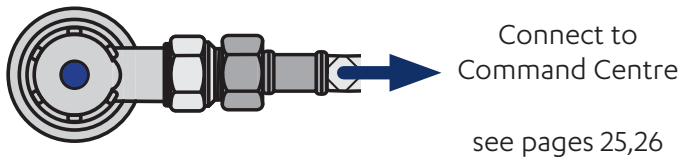
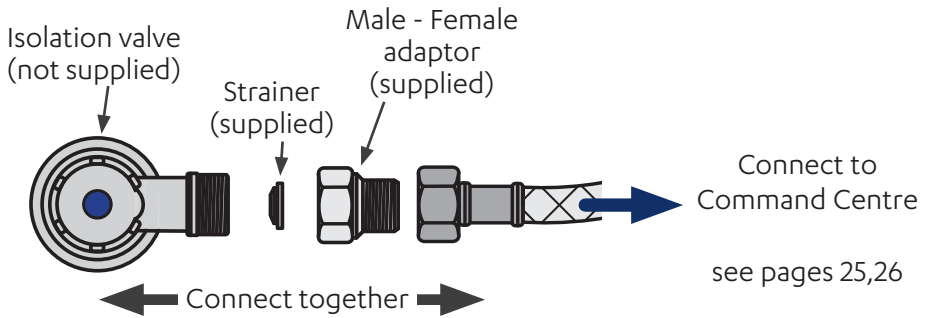

SECTION 9: Set the bypass & install the limescale filter

Available as optional accessory - UK only.



For filter head and scale filter installation use the guide supplied with the filter head and filter respectively.



Flush filter before use.

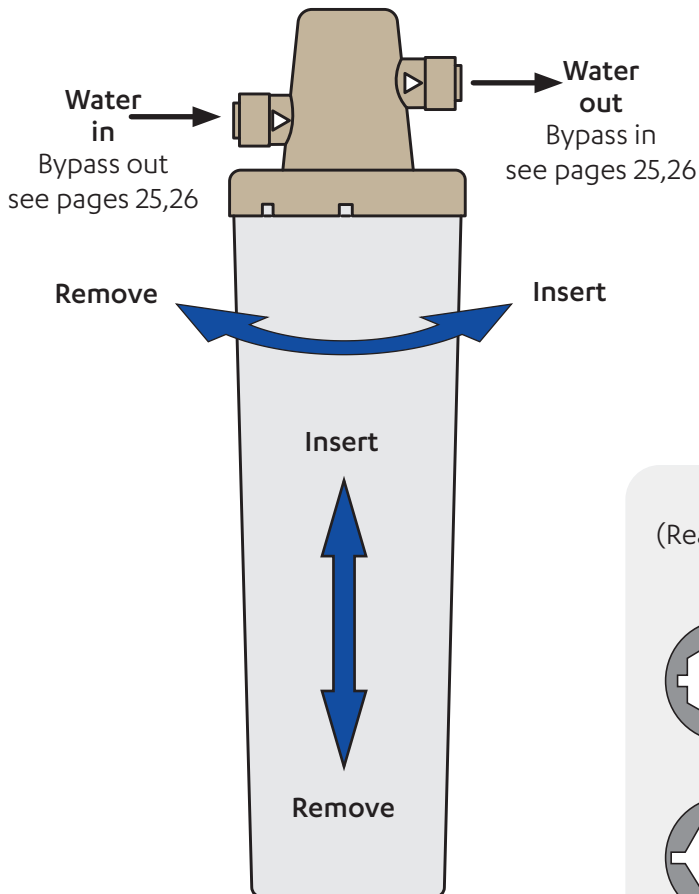

Bypass valve

(Rear of the Command Centre)

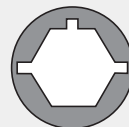
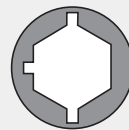

SECTION 10: Fit the booster

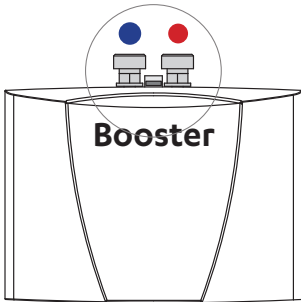

Supplied with selected models, or available as an optional accessory.

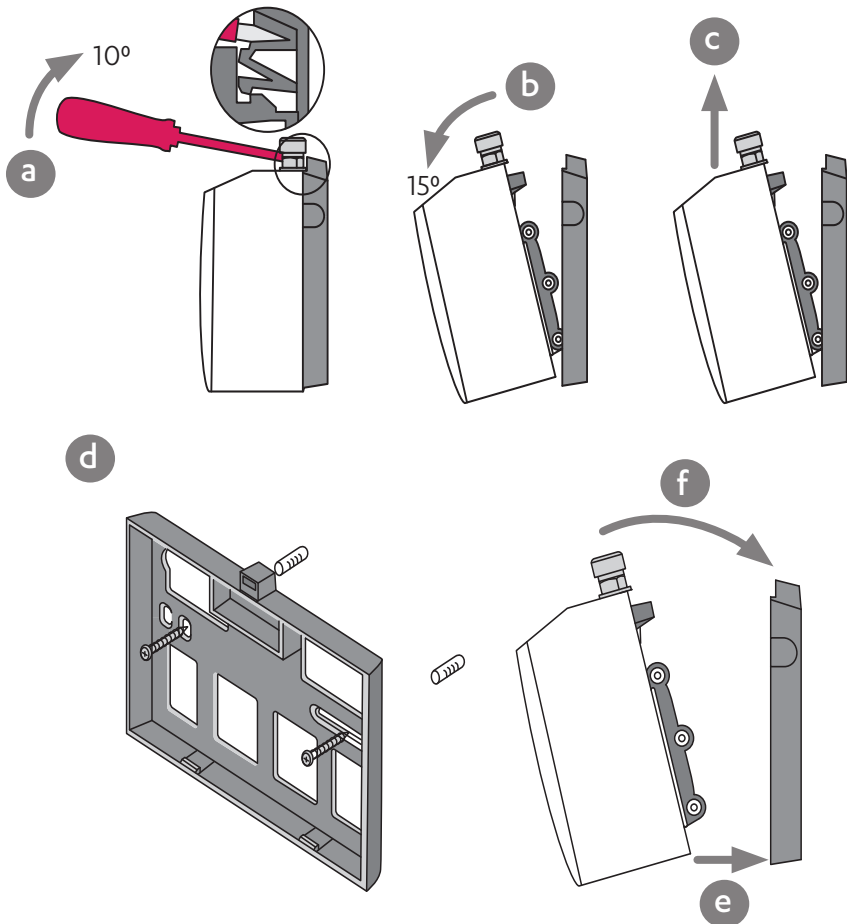

Note: Take care not to break the clips when removing or installing the booster.

SECTION 11: Connect the Booster

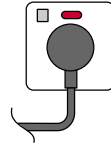
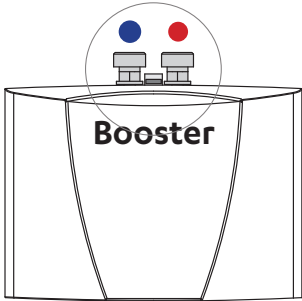

Connect electricity



**Do not switch on electrical power until commissioning.
Do not over tighten hose connections.
Braided hoses supplied cannot be lengthened.**

Cold water into booster,
connect to Command Centre
BYPASS OUT
see pages 25,26

Hot water out of booster,
connect to Command Centre
BYPASS IN
see pages 25,26

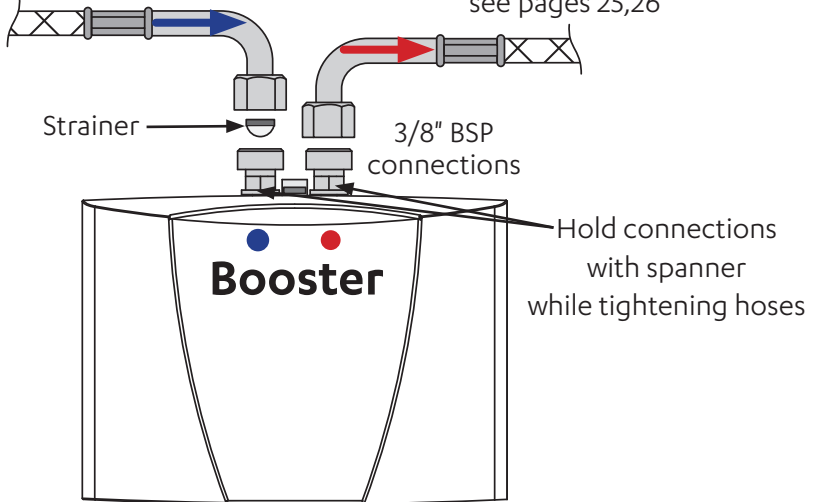

SECTION 12: Install the CO₂ cylinder and regulator



Be aware of the risks of hazards which could cause harm when handling compressed CO₂.

Read the important safety instructions at the start of this instruction manual.

Assess the risks before starting the installation.

Secure the cylinder

Ensure there is sufficient space to safely secure the cylinder and regulator.

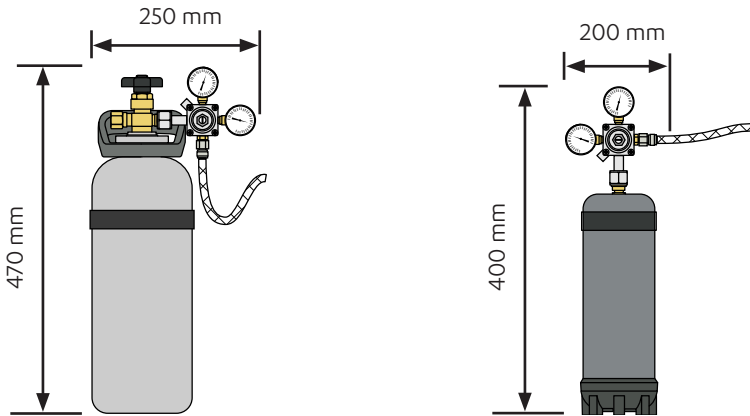

Secure cylinder vertically to a robust surface with the hook & loop strap and bracket supplied.

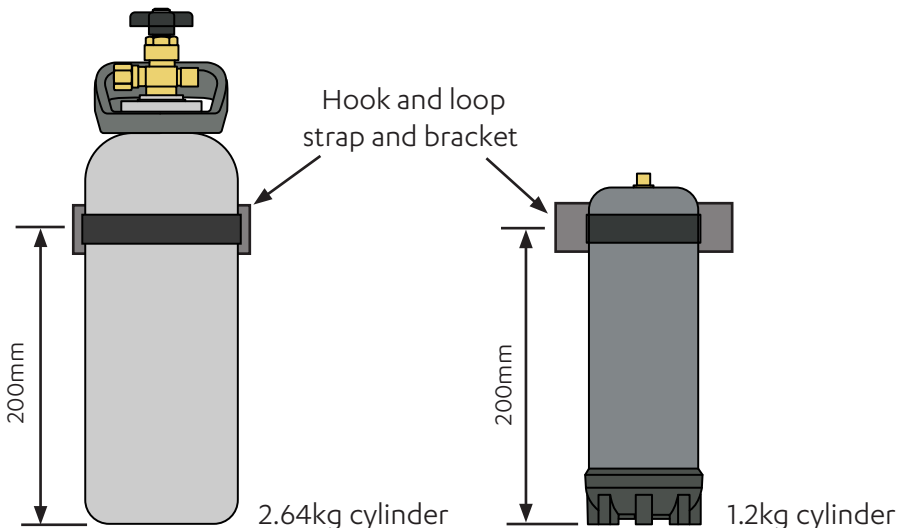

SECTION 12: Install the CO₂ cylinder and regulator

CO₂ regulator identification

Universal G5 regulator

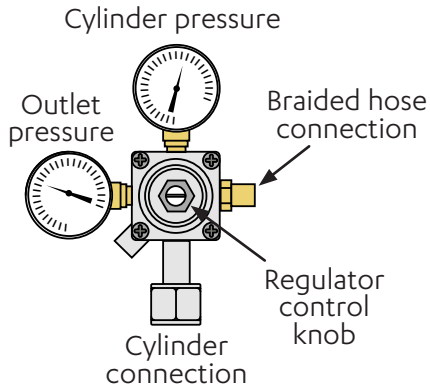

1.2kg cylinder non-adjustable regulator

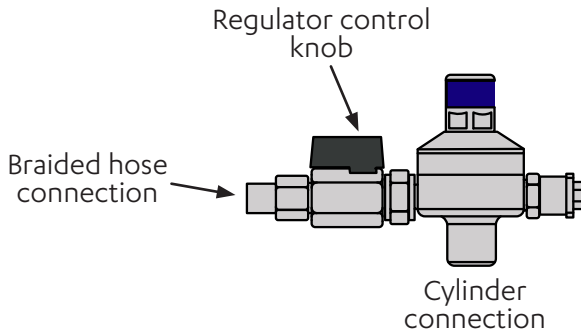

SECTION 12: Install the CO₂ cylinder and regulator

Fit the regulator and connect the gas hose

- Ensure all mating surfaces are clean.
- Turn the regulator OFF.
- Check the regulator and hose seals, inside the connectors.
- Connect the gas hose to the regulator.
- Carefully screw the regulator onto the cylinder connection.
- For the 1.2kg cylinder and Universal G5 regulator use the adaptor supplied.
- Connect the gas hose to the Command Centre (see section 13).



Do not proceed if the seals are damaged.

Take care not to cross thread the regulator; a cross threaded regulator poses a potential hazard.

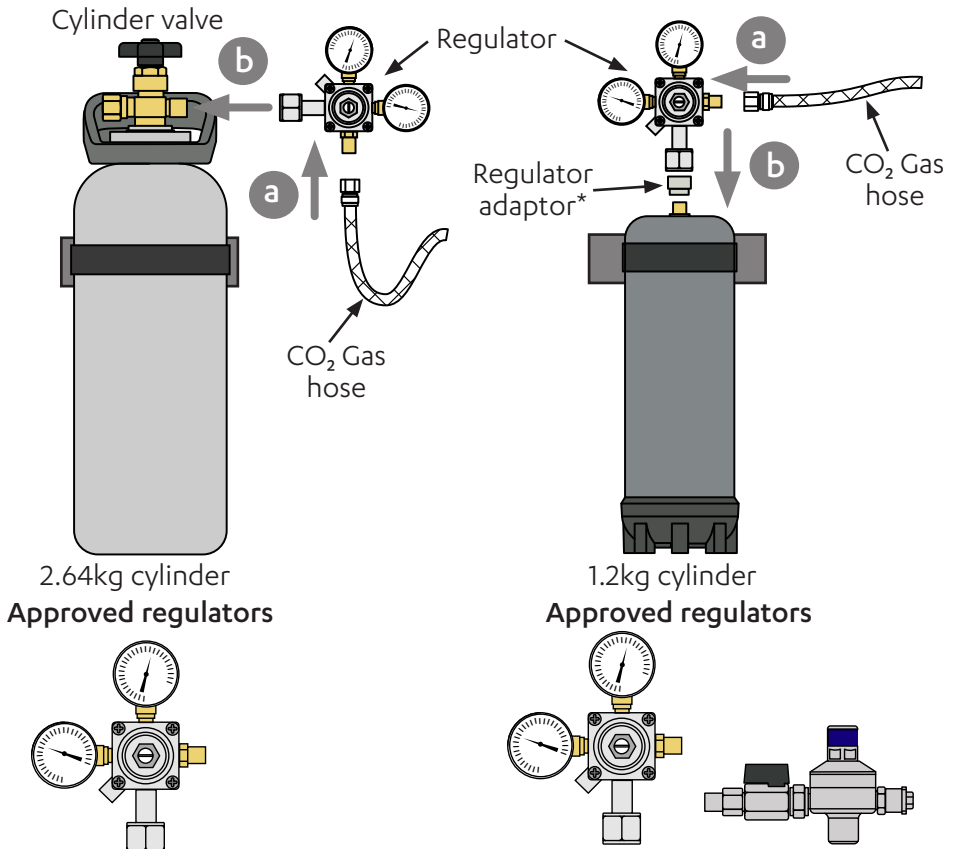

*The regulator adaptor is only required for the Universal G5 regulator.

SECTION 12: Install the CO₂ cylinder and regulator

Adjust the regulator

Universal G5 regulator

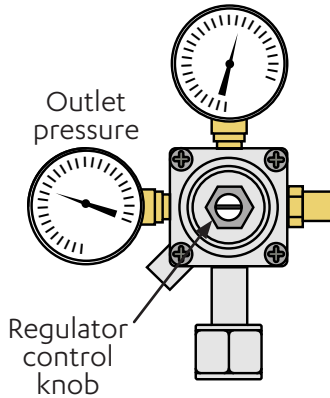

- Check the regulator is turned all the way OFF (anti-clockwise).
- Turn the gas ON using the cylinder valve (2.64Kg cylinder), (anti-clockwise).
- Turn the regulator control knob (clockwise +) to adjust the outlet pressure to 3.0 bar on the outlet pressure gauge.

Turning the regulator ON and OFF

1.2Kg cylinder Non-adjustable regulator

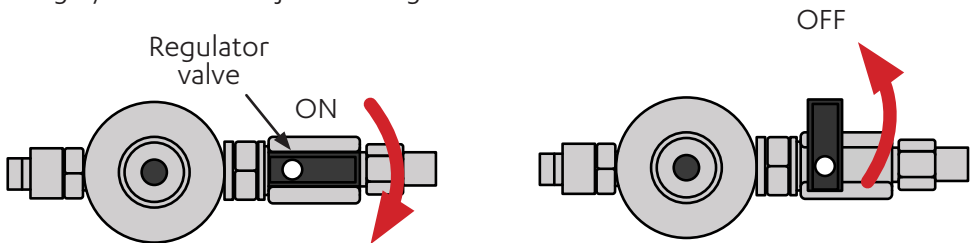

- Turn the regulator valve fully clockwise to turn ON the gas.
- Turn the regulator valve fully anti-clockwise to turn OFF the gas.

SECTION 12: Install the CO₂ cylinder and regulator

Test for leaks



Care must be taken when working with high pressure carbon dioxide, and in no case should the normal operating pressure of 3.0 bar be exceeded.

- Apply soapy water to the gas connections (see below), using a brush.
- If there is a leak, bubbles will appear.
- In the case of a leak, turn OFF the gas, clean away the soapy residue and re-seal the leaking connection.

Test for leaks
in these areas

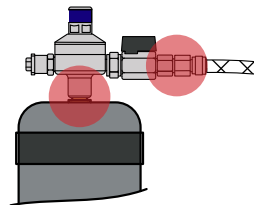
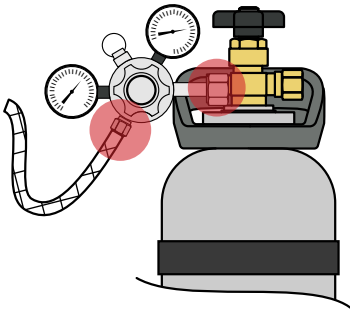
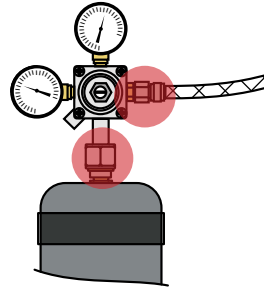
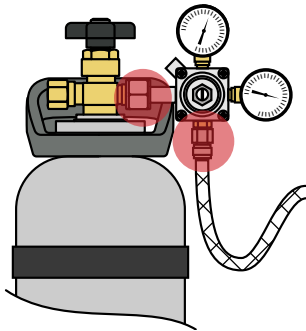

SECTION 13: Connect the Command Centre

Generic installation instructions



For HydroTap, mixer tap and any optional accessories, use instructions supplied with individual kit components.

Mains power cable

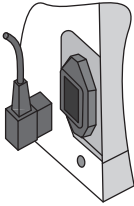

USB

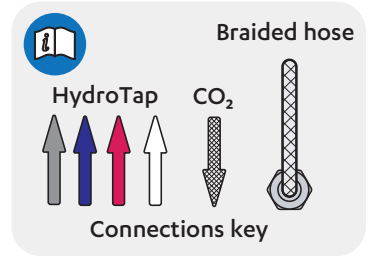
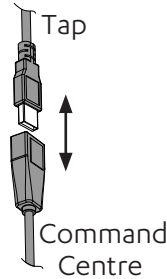

Installation diagrams are for illustrative purposes only.

Hoses are not shown to scale and cannot be lengthened.

Tips for hose connection

- Push the silicone hose over the connector for a minimum of 15mm.
- Ensure there is a constant fall from the tap down to the command centre.
- Hoses must be trimmed to avoid loops and kinks. Take care when positioning before cutting and make a clean cut straight across the hose, using a sharp blade.
- The hoses must not be under tension when installed.

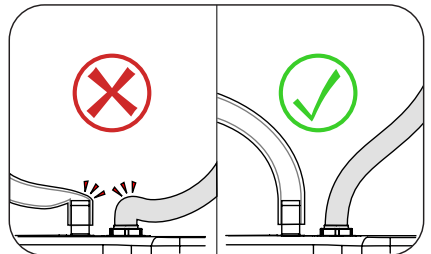
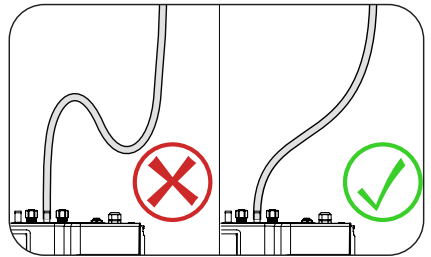

SECTION 13: Connect the Command Centre

BCS60, BCS100 models

Booster (selected models) and
limescale filter (optional)

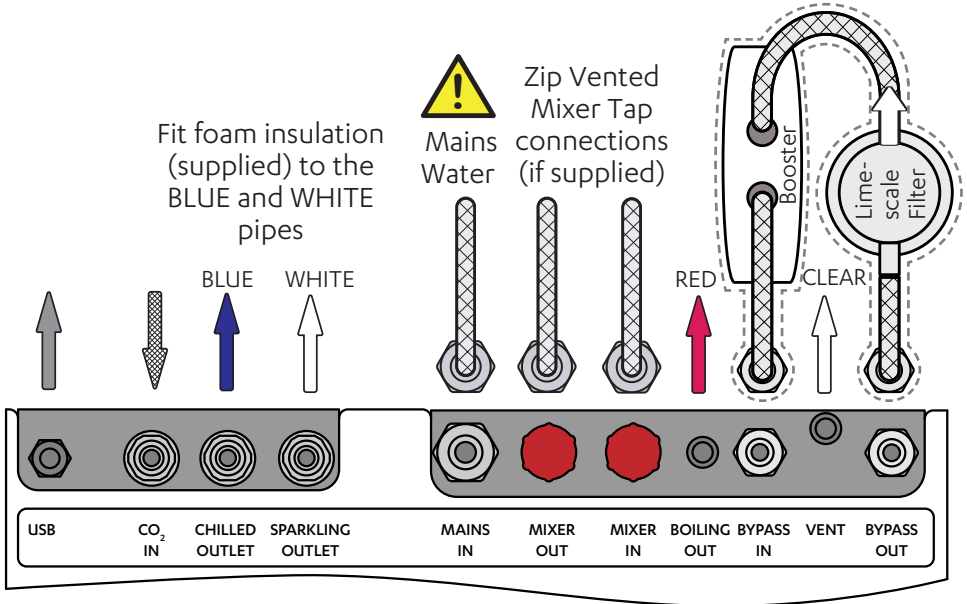

Example installation

Diagram for illustrative purposes only.
Hoses are not shown to scale, as the booster hoses cannot be lengthened.

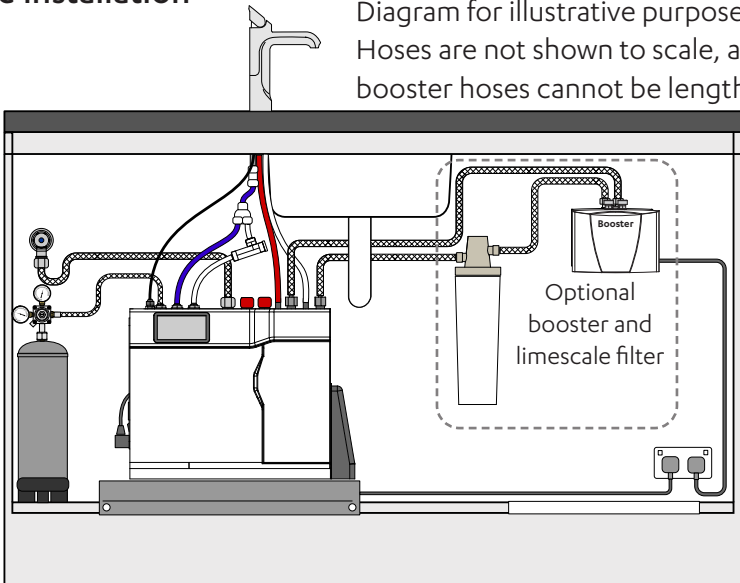

SECTION 13: Connect the Command Centre

BCS20, BCS30, BCS Home models

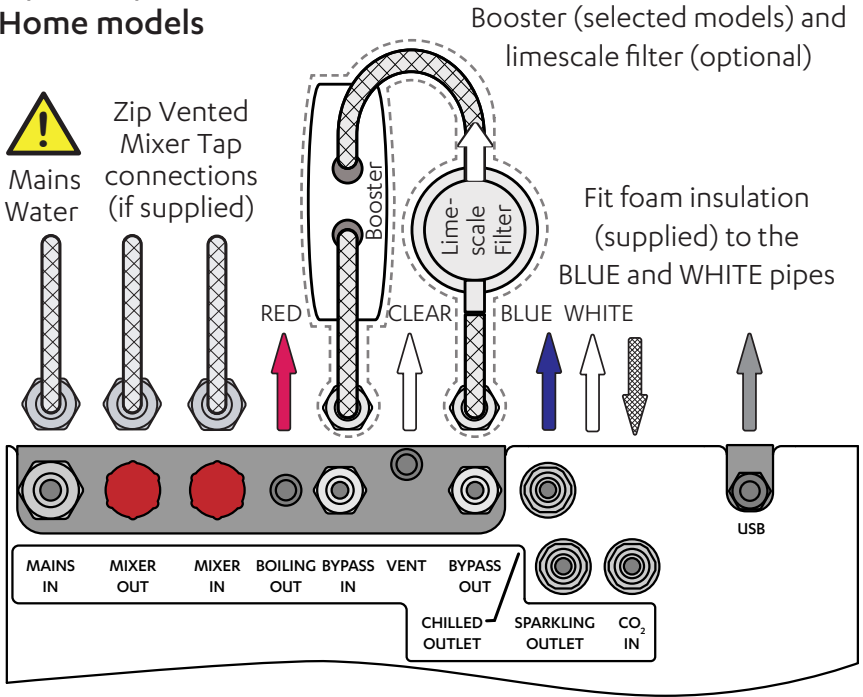

Example installation

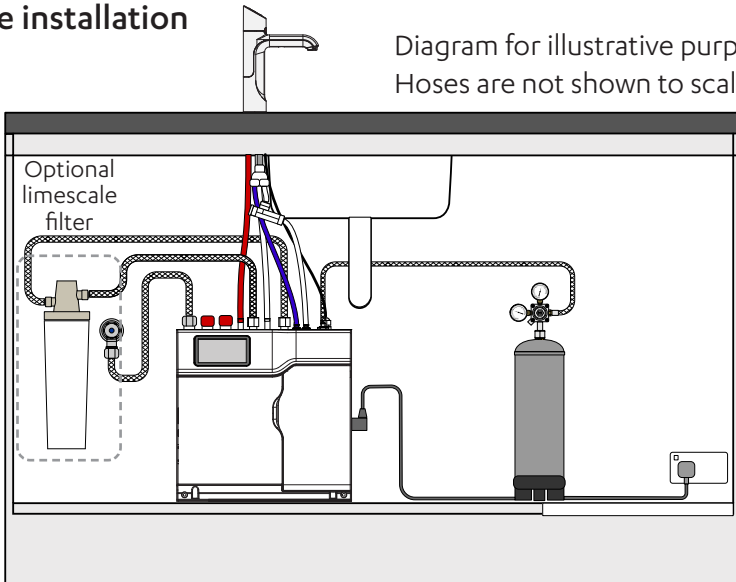



SECTION 14: Commissioning

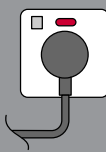

1  See User Guide
Unpack, moisten o-rings & fit filter

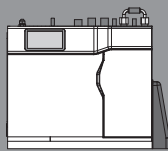
2  Connect electricity

3  Monitor display screen

4  Set Language

5  Purge CO2

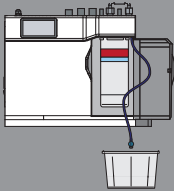
6 

7  Filter flush

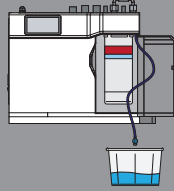
8  Flush 10 Litres through

9  Boost enable if booster fitted

10  Power off
Pull levers forward
Power on

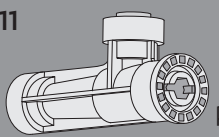
11  Safety calibration (if required; Classic Tap only)

12  Dispense water as instructed

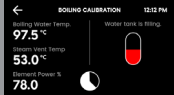
8  Boiling calibration

9  Boost enable if booster fitted

10  Power off
Pull levers forward
Power on

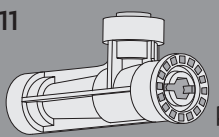
11  Safety calibration (if required; Classic Tap only)

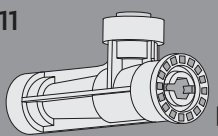
11  Adjust carbonation valve See page 14

Refer to User Guide for operation and maintenance.



Zip Water UK

Trafalgar House, Rash's Green,
Dereham, Norfolk, NR19 1JG

0345 6 005 005

sales@zipindustries.co.uk

specify.zipwater.co.uk

