

AC-Dual PRO USER MANUAL

Congratulations on the purchase of the AC-Dual PRO

Refrigerant Processor

This is a very good investment you have made for your workshop. This system will help your technicians in achieving their best capability in diagnosing and rectifying air-conditioning issues, thus increasing productivity and profitability for your business. This system can be customized to suit each individual workshop needs. Our company would like to work with you as partners in your business to help you achieve maximum return on your investment, so please do not hesitate to contact us or our distributors, if we can be of any further assistance in relation to this equipment use and maintenance, or any air-conditioning related issues. We are always here to help you in achieving higher productivity.

AC-Dual PRO is an ideal option for workshops that have requirements of handling both R-134a and HFO-1234yf refrigerants. The loss of refrigerant is minimized to less than 50 gram at shifting from one refrigerant to another, and deep internal evacuation ensures zero cross contamination between two refrigerants. The machine is equipped with 2 refrigerant tanks, which saves the operators' time of replacing tanks.

The unique design has facilitated quick load cell unlock, easy and economic maintenance (even though DIY maintenance is facilitated by our machine design, it is still highly recommended to leave maintenance job to specialized technicians.), self troubleshooting and convenient USB upgrade etc..

General safety

- The storage cylinder in this unit contains liquid refrigerant. Overfilling of the cylinder can cause violent explosion. Do not disable the overfill safety feature. Always keep the cylinder on the load cell platform whenever operating the machine.
- The operator must carefully read the instruction manual before any operation is performed. Incorrect operations could cause serious consequences, such as, improper A/C service, damage to automotive A/C system or damage to equipment.
- Only use cylinders which are recommended by the manufacturer and supplied with this equipment.
- Avoid inhalation of refrigerant or oil vapor/mist, read material safety instructions on refrigerant and oil package.
- Switch off and disconnect power cable from main supply before removing any cover or servicing the equipment, to avoid electric shock which can be very dangerous or fatal.
- Never use compressed air for leak testing the unit or vehicle A/C system!
- Wear safety goggles and gloves, to protect eyes and skin from contact with refrigerant. Coming in contact with liquid refrigerant can cause frostbite and blindness. If accidental contact is made with liquid refrigerant, wash effected area with plenty of fresh water and contact a doctor.
- Avoid using extension power cable with copper core diameter less than 1.5mm².
- Keep gasoline or other flammable substances away from the equipment.
- Always operate unit in a well-ventilated area and away from artificial heat

Index

General safety	2
Specifications	2
Function Table	3
Equipment description	4
Operation preparations	5
Equipment Connection	7
Recovery	8
Vacuum	8
Charge	9
Tank fill	9
Auto. mode	10
System setting	11
Update	12
Main troubleshooting	14

Specifications

- Dimension: Package 710*660*1190mm; Unpacked machine 610*595*1075mm
- Input power: AC110V±10%~60Hz
- Pre-ventilation: After power witch is turned on, the machine makes 30 seconds ventilation, before it is powered on
- Compressor power: 3/8HP
- Average gas state refrigerant recovery speed (through charge/suction port): 0.25Kg/min.
- Recovery rate: 96%
- Vacuum pump capacity: 120L/min, non-sparkle
- Vacuum leak test, 1-60 minutes
- Accuracy of gas cylinder load cell: ±10g
- Capacity of dual gas cylinders (one for R-134a, one for HFO-1234yf): 10KG
- New oil bottle capacity: 250ml
- Used oil bottle capacity: 250ml
- Accuracy of New / Used oil bottle : ±5g
- Dual condensers and cooling fans, one for R-134a, one for HFO-1234yf
- Max. Pressure: 20bar
- Charge speed: 2Kg/Min(max.)
- LCD display: 7-inch, touch screen
- Thermal printer
- High pressure gauge range: -1bar~40bar
- Low pressure gauge range: -1bar~22bar
- Automatic service reminding. The equipment filter-drier life is designed to desiccate and recycle 100 KG refrigerant. Upon filter-drier life expires, the machine is automatically locked and a machine maintenance needs to be performed. A machine maintenance includes, but not limits to, filter-drier replacement, but also pump lubrication oil replacement, solenoid spool washer replacement, leak test etc.
- Can be used for fuel, hybrid or electric vehicles
- In-built HFO-1234yf refrigerant identification, accuracy 0.1%, identification time 120 seconds.
- Two dry filters,600ml for each
- Automatic air purge included
- Oil-free compressor

Function Table

Main function	Recovery	Recovers and purifies refrigerant from automotive A/C to equipment tank.
	Vacuum	Evacuates air and moisture from the A/C system. Upon completion of vacuum, manual oil injection is prompted.
	Charge	Charge refrigerant from equipment gas cylinder to automotive A/C system
	Tank fill	Transfer liquid refrigerant from an external refrigerant storage cylinder to equipment cylinder.
	Auto. mode	Performs the selected functions in a fully automatic sequence. The machine will stop automatically once all the selected functions have been completed
Sys. setting	Language	Select operation language.
	Calibration	Calibration refrigerant gas cylinder load cells.
	Database	Enter automotive A/C database
	Unit set	Select metric or imperial units
	Empty container weight set	Set empty refrigerant gas cylinder.
	Component test	Test work status of solenoids, vacuum pump and compressor.

Equipment description

Front view

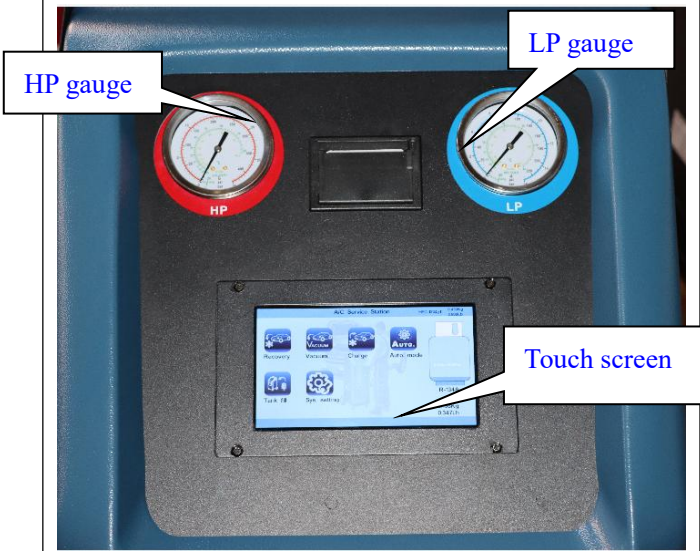

Back view

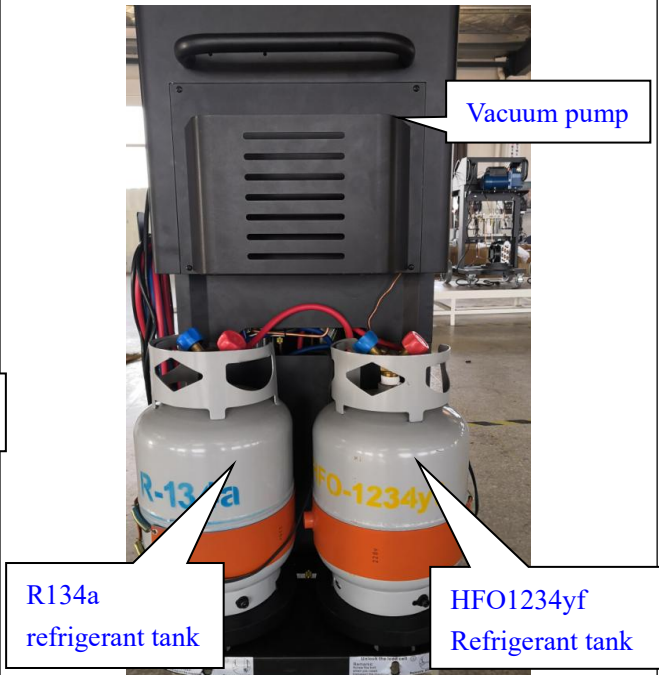

Left view

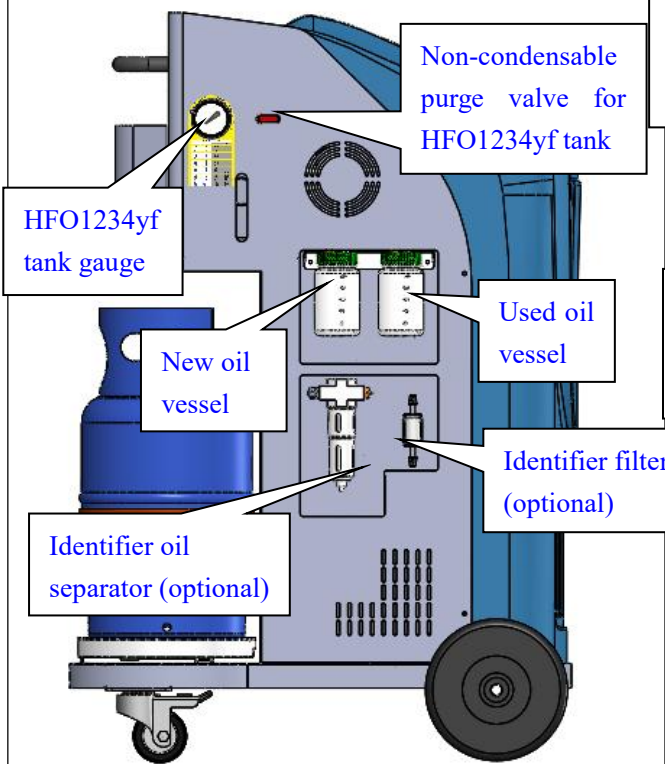

Right view



Operation preparations

■ Unlock load cells

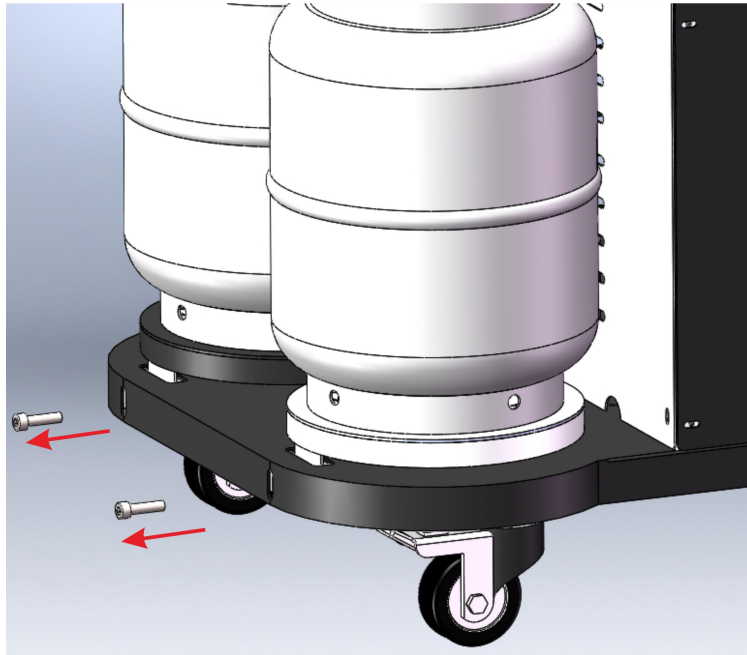

Remove the two lock bolts, to release load cells of the two tanks, and to make them ready to work.

Warning:

1. *Failure to remove the load cell lock bolts may cause wrong refrigerant processing amount.*
2. *When you need transport the machine, please screw those bolts on.*

■ Fill equipment with refrigerant (New equipment is empty, you need to fill the equipment with refrigerant and refrigeration oil)

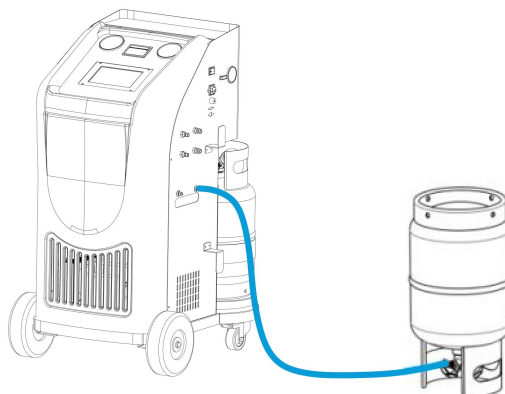

Through tank fittings, connect either HP or LP hose with external refrigerant R134a or HFO-1234yf, and turn on the machine, select “Tank fill” function, set tank fill amount to fill R134a or HFO-1234yf tank with refrigerant.

It is recommended to maintain refrigerant level of both tanks at 4-6kg.

■ Non-condensable purge

If the machine was ordered with automatic air purge function, it purges non-condensable automatically according the refrigerant pressure temperature character.

Otherwise, you need to purge the air in equipment tanks by turning the air purge valves. At left and right sides of machine, non-condensable purge manual valves and pressure-temperature chart can be found. Turn the valve to purge the non-condensable, strictly abiding by the pressure-temperature chart sticker.

■ Set altitude

Enter “System setting”, select “Altitude”, input the altitude where the equipment is located. This is to ensure to make accurate refrigerant identification.

Drain oil separator and replace oil filter, both located at left side of the machine

Drain the oil separator if there is oil in it (transparent, oil inside visible).



Replace the oil filter each year, or any time oil stain point visible.

■ Select refrigerant

Each time the machine is turned on, it reminds to select refrigerant type. If the refrigerant type selected is different from the refrigerant handled at previous operation, the machine automatically recovers refrigerant inside machine pipelines, and makes extremely deep internal evacuation, and then shifts to the interface of the selected refrigerant. This process may take 10 minutes or more.

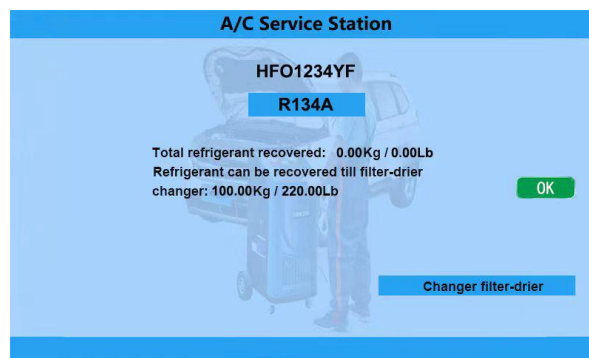

Notes:

- 1. Be sure you select same refrigerant type as what the vehicle contains, or serious contamination in equipment tanks will be caused.***
- 2. Anytime you desire to shift from the refrigerant which machine currently handles to another, turn the machine off and turn it on again, and then select refrigerant type.***

Equipment Connection

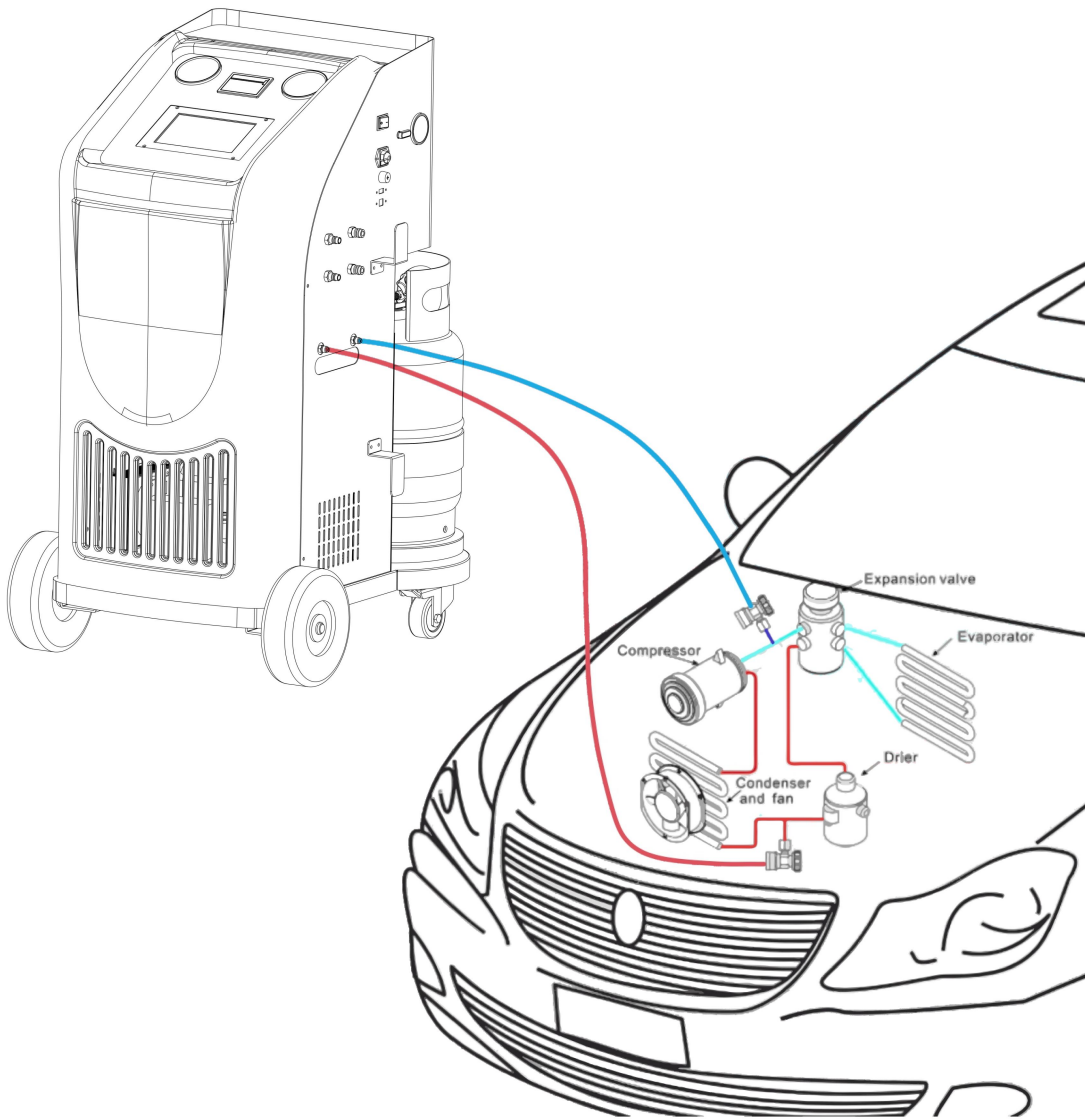

Warning: Except the situations clearly stated in the manual, during all equipment operations, please maintain the vehicle engine and A/C off, otherwise unexpected damages may be caused.

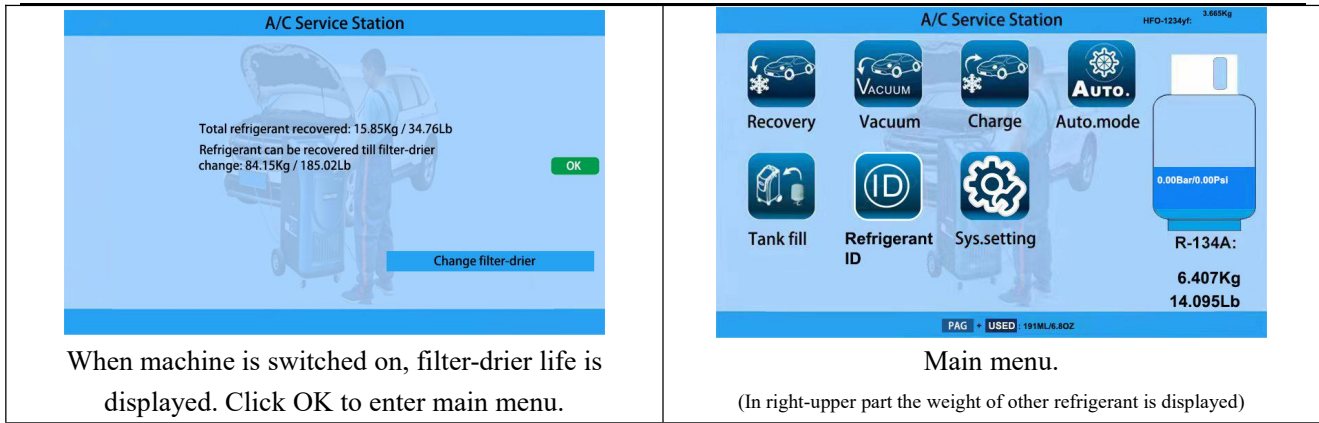

Recovery

Empty used oil vessel before the recovery function is started.

Select “Recovery” function icon and press ENTER to start the process.

The recovery process recovers the refrigerant from vehicle A/C system, until vacuum degree is achieved in the vehicle A/C system. Moisture, oil and foreign particles are separated from the refrigerant before it is stored in the internal refrigerant cylinder. The machine should be left connected on the vehicle for a minimum time of 3 minutes (longer in cold climates) for any pressure increase test. If after 3 minutes (or longer if possible) there is no pressure increase, the recovery can be acknowledged completed. If a pressure increase is detected recovery should be processed again.

Remarks: For machine with optional in-built HFO-1234yf identifier, before the recovery of HFO-1234yf happens, the machine makes 120-second gas identification. If the HFO-1234yf concentration is higher than 98%, the recovery is permitted and started; otherwise, the recovery is prohibited, an internal vacuum is made, and the gas concentration is displayed.

Vacuum

Select “Vacuum” icon in the main menu, set vacuum time and click OK to start the process.

The Vacuum process evacuates system, and makes system ready for oil injection and refrigerant charge. Although it is up to users to determine vacuum time, a longer vacuum process is recommended.

After vacuum, the machine prompts to inject oil by turning the new oil vessel hand valve at the machine side for fuel vehicles; For hybrid and electric vehicles, oil injection through the machine is prohibited, and it is recommended to inject oil with specialized oil injection tool.

Warning: PAG oil for fuel vehicle is electricity-conductive. Very few PAG oil being injected into hybrid/electric vehicle could bring about serious consequence.

Charge

Select “charge” icon and click OK to start the process.

According the vehicle being serviced, select “Normal charging” (Fuel vehicles) or “High voltage charging” (Hybrid or electric vehicles). In normal charging mode, hose flush (flush with liquid refrigerant to remove the oil residue inside the service hoses) is optional; while in high voltage charging mode, hose flush before oil injection and refrigerant charging is a must.

You can manually set charge amount with volume, or select “Charge by database” to set charge amount by car make and model.

You can choose to charge through high side, low side or both sides.

After charge and A/C performance is checked with engine started and A/C turned on. “Hose purge” is performed to help charge the refrigerant in service hoses into vehicle A/C system, to ensure better charge precision.

Tank fill

Select **Tank fill** to fill or add refrigerant into machine storage cylinder. It is recommended to maintain 4-6 kg refrigerant in the machine internal cylinder at all time, to guarantee better charging and flushing operations.

During the refrigerant cylinder filling process the machine will display to the technician to **close hand valve on the external cylinder**, the machine will then recover the rest of refrigerant left in the transfer service hose and internal pipelines.

The minimum tank fill set value is 0.5kg.

The maximum tank fill set value is the calculation result of 8kg (80% of tank allowable maximum weight) minus amount of refrigerant the tank contains (For example, if there is 2kg refrigerant in the equipment tank, the maximum tank set value is 6kg).

Remarks: For machine with optional in-built HFO-1234yf identifier, before the tank fill of HFO-1234yf happens, the machine makes 120-second gas identification. If the HFO-1234yf concentration is higher than 98%, the tank fill is permitted and started; otherwise, the tank fill is prohibited, an internal vacuum is made, and the gas concentration is displayed.

Auto. mode

Empty used oil vessel before the process.

You can select “Auto.mode” to do full cycle of recovery, vacuum, oil injection and charge.

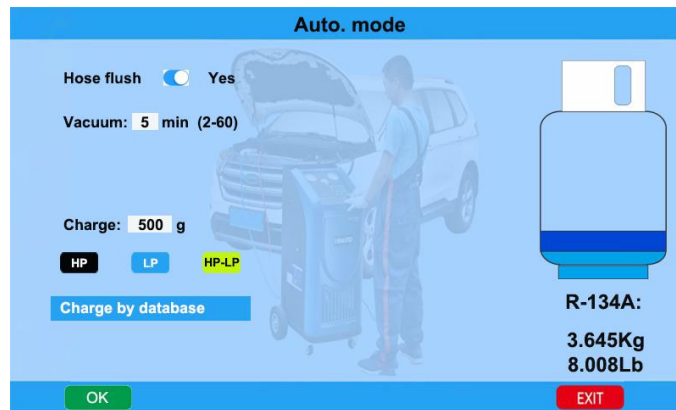

You can select “Auto.mode” to do full cycle of, recovery, vacuum and charge.

According the vehicle being serviced, select “Normal charging” (Fuel vehicles) or “High voltage charging” (Hybrid or electric vehicles). In normal charging mode, hose flush (flush with liquid refrigerant to remove the oil residue inside the service hoses) is optional; while in high voltage charging mode, hose flush before oil injection and refrigerant charging is a must.

In Auto. mode, the machine makes recovery, vacuum, oil injection (for fuel vehicles) and refrigerant charge in sequence automatically, with data preset by users.

Empty used oil vessel before the process.

Remarks: For machine with optional in-built HFO-1234yf identifier, before the automatic mode of HFO-1234yf happens, the machine makes 120-second gas identification if there is refrigerant in A/C system. If the HFO-1234yf concentration is higher than 98%, the process is permitted and started; otherwise, the process is prohibited, an internal vacuum is made, and the gas concentration is displayed. The only possibility that the automatic process can be effected is that, there is no refrigerant in A/C system, thus the process happens in vacuum-oil injection-charge sequence, without recovery function.

System setting

Select “system setting” icon and input PW 111111 (left and right arrow to move cursor, up and down arrow to increase/decrease number) to enter system setting menu. In system setting, “Language”, “Calibration”, “Database”, “Unit set”, “Empty container weight set” and “Component test” can be inquired or reconfigured.

Language

Can change operation system language.

Calibration

It is suggested to have only professional technicians to do calibration of load cells. The load cell calibration is very simple and fast, with just one step, 1kg weight calibration step.

Warning: Misoperation in calibration could bring about serious consequences to equipment or vehicle A/C system.

Database

Users can access database of refrigerant/oil volume of different car makes and models.

Unit set

To set metric or American imperial unit. The two numbers displayed in the bottom part of the interface are values of two tank load cells, for load cell diagnosis purpose.

Empty container weight set

The total load cell reading equals the sum of empty container weight and net refrigerant content value. Thus, increase/decrease empty container weight, can correspondingly decrease/increase refrigerant value displayed in the main operation interface.

Component test

Users can activate/dis-activate different electronic component of the machine. This is for quick and easy diagnosis for troubleshooting.

Altitude

Set altitude, to ensure accurate refrigerant identification.

Update



Save the dwin-set file in the SD card.

Insert the SD card into the card holder at the back board of the touch screen:



Switch off the machine, remove the SD card and restore the machine:



Switch off the machine, unscrew the 4 bolts of the panel cover to expose the touch screen.

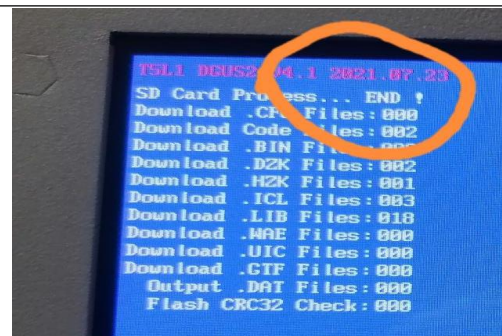

Switch on the machine and the machine makes update itself, and prompt "End" when update is accomplished.

Switch on the machine, and the machine runs the new software.

Service reminding & reset

Before total 100KG refrigerant is recovered, please select “Change filter-drier in when machine is switched on.

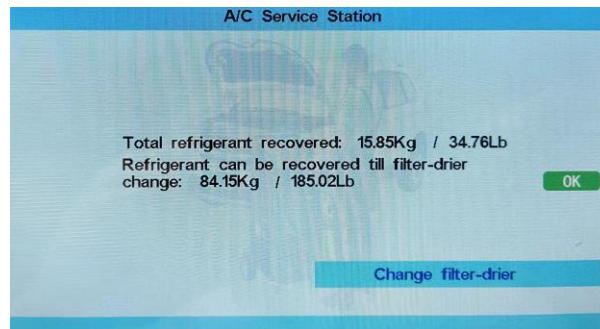

When this interface appears, call your equipment supplier, and send the number in the interface to get a dynamic password (each time the password is different).

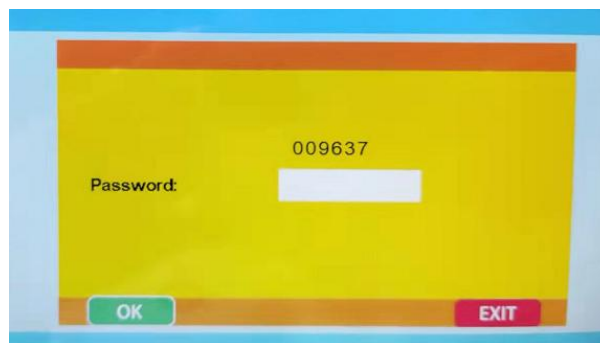

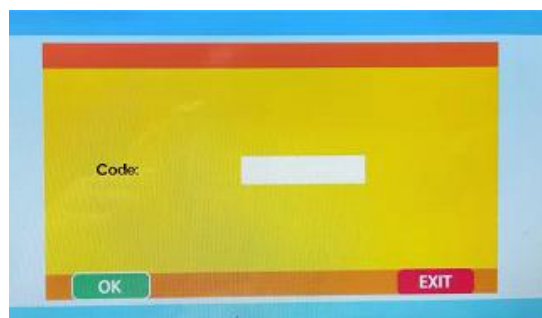

After the dynamic password is correctly input and OK is clicked. The machine asks to input filter-drier code. Please enter the code on the new filter-drier provided by the distributor.



Click OK, if the code is recognized by the machine, the machine will evacuate 60 seconds and another 100KG refrigerant is permitted to be recovered.

Main troubleshooting

Malfunction	Reasons	Solution
Low vacuum degree	<ol style="list-style-type: none"> 1. Insufficient vacuum pump oil. 2. Pump oil emulsion, dirty 3. Pump oil inlet plugged. 4. Leakage in pump connection. 5. Components worn out. 	<ol style="list-style-type: none"> 1. Add oil to central line 2. Put new oil 3. Clean oil inlet. 4. Check connection 5. Maintain the machine, especially o-ring, washer and other sealing parts.
Vacuum pump inject oil.	<ol style="list-style-type: none"> 1. Excessive oil volume. 2. Entrance pressure too high. 	<ol style="list-style-type: none"> 1. Discharge some oil to proper level 2. Run Recovery function first.
No display	<ol style="list-style-type: none"> 1. Fused (in Power cable connection box, or PCA) 2. PCA burnt. 3. Power cable loosened. 4. LCD not work 	<ol style="list-style-type: none"> 1. Change fuses. 2. Change PCA. 3. Connect power cable reliably. 4. Change LCD.
Recovery does not stop	<ol style="list-style-type: none"> 1. Leakage in automotive A/C or equipment pipeline. 2. Compressor not work 3. Pressure sensor does not work <p>Remarks: In winter, it is normal that recovery takes longer time.</p>	<ol style="list-style-type: none"> 1. Make leakage test. Machine leakage test with reference to service manual. 2. Change compressor. 3. Fasten pressure sensor connection to PCA, or change the pressure sensor.
No change in recovery volume	<ol style="list-style-type: none"> 1. No refrigerant in A/C. 2. Support screw of gas cylinder load cell not loosened. 3. Gas cylinder load cell not work or PCA failure 	<ol style="list-style-type: none"> 1. Stop recovery. 2. Unscrew the protection screw, as chapter "Operation preparations". 3. Calibrate gas cylinder load cell, or change the load cell, or change PCA.
While auto A/C has refrigerant, equipment displays alarm 005	Low pressure switch plug disconnected from PCA socket.	Fasten low pressure switch plug.
High pressure alarm 004 but gas cylinder gauge does not show excessive pressure value	<ol style="list-style-type: none"> 1. High pressure switch plug disconnected from PCA socket. 2. Pipeline connecting compressor exit blocked. 	<ol style="list-style-type: none"> 1. Fasten high pressure switch plug. 2. Inspect the hoses and connections between compressor exit and tank blue hand vale.
No charge or slow charge.	<ol style="list-style-type: none"> 1. Insufficient refrigerant in equipment 2. Charge line problem. 	<ol style="list-style-type: none"> 1. Fill equipment tank with more refrigerant. 2. Check charge line, including tank red valve, tank red hose, solenoid #5, solenoid #9 (high side), solenoid #11 (long side), service hoses and HP/LP quick couplers.

<p>During recovery, vacuum pump is pressurized. After period too much oil in vacuum pump</p>	<p>The contact between solenoid valve #8 and valve base is not well sealed.</p>	 <p>Remove solenoid #8 from valve base, clean the solenoid valve and valve base.</p>
<p>During vacuum, there is suction in old oil bottle.</p>	<p>The contact between solenoid valve #2 and valve base is not well sealed.</p>	 <p>Remove solenoid #2 from valve base, clean the solenoid valve and valve base.</p>

Remarks: Regular maintenance by specialized technicians may largely reduce machine failure.