

AIR-095 USER MANUAL

Congratulation on the purchase of the AIR-095 Electronic Refrigerant Processor.

This is one of the best investment you have made for your workshop. Due to the company continues research and development and the joint effort of design, electronic and mechanical engineers including our sales representatives, air-conditioning manufactures and discussing the needs and issues of various workshop operators, in various countries around the world. We have manufactured one of the world most user friendly, efficient and smart refrigerant processor. The AIR-095 refrigerant processor incorporates electronic intelligent using android platform. This system will help your technicians in achieving their best capability in diagnosing and rectifying air-conditioning issues, thus increasing productivity and profitability for your business. Our company would like to work with you as partners in your business to help you achieve maximum return on your investment, so please do not hesitate to contact us or our distributors, if we can be of any further assistance in relation to this equipment or any air-conditioning related issues. We are here to help you achieve your goal.

INDEX

Specifications.....	2
General safety guide.....	3
Component identification.....	4
Function operation and description.....	6
First operation.....	7
1. Unlock tank load cell.....	7
2. Tank fill.....	7
Operating procedure.....	8
Recovery function.....	8
Evacuation function.....	8
Refrigerant charging function.....	8
Tank fill.....	9
Flushing function.....	10
Automatic function mode.....	10
System setting.....	11
Calibration:.....	11
Air purge:.....	11
Database:.....	11
Unit settings:.....	11
Empty container weight set.....	11
Component test:.....	11
Operation record:.....	11
Owner information:.....	11
Machine Maintenance.....	12
Changing solenoid or spool seals.....	12
Vacuum pump oil change.....	12
Main filter-drier replacement.....	错误! 未定义书签。
Compressor oil change.....	14
Oil vessel filter-drier replacement.....	14
Calibration of load cells, pressure transducer and temperature sensor.....	15
Caring for your equipment.....	166
Packing list.....	166

Specifications

- Packaged machine dimension: 720*780*1285mm
- Unpacked machine dimensions: 644*731*1147mm
- Mains power supply: 220vAC±10%~50/60Hz, or AC110V±10%~60Hz
- Compressor power: 3/8HP
- Max. refrigerant recovery speed: 0.25Kg/min.
- Vacuum: pump capacity: 120L/min
- Evacuation time selection: 2-240min,
- Vacuum leak test time selection: 0-30min.
- Flush function: Unidirectional or bi-directional, time selection: 10-60 min.
- Electronic oil injection: 3 separate vessels, 250ml capacity ea. for PAG /POE/UV, high transparency
- Used oil vessel: 400ml capacity, high transparency
- Refrigerant charging speed: 2Kg/Min.
- High capacity spin on filter-dryer: 600ml capacity:
- Accuracy of refrigerant cylinder load cell: ±10g
- Accuracy of oil containers load cells: ±1g
- Refrigerant cylinder: 18KG at 80% capacity, with heater band.
- Machine maximum working pressure: 20bar with electronic high-pressure protection warning and safety release valve.
- Display: 7" touch screen, powered by android platform.
- Gauges: High side -1bar~30bar, Low side -1bar~16bar,
- Digitally displayed cylinder pressure and temperature
- Vehicle A/C database included, with additional user database input.
- Thermal printer
- Electronically controlled air purge.
- Electronically monitoring and displaying system service intervals.
- *AIR-095 is suitable for R134a or 1234yf refrigerant.*
- *Refrigerant Identifier (optional)*

General safety guide

- **This equipment must only be operated by qualified technicians.**
- Read instruction manual carefully before operating this equipment. If there is anything you do not fully understand, please contact your distributor or manufacturer. We like to help.
- The refrigerant storage cylinder contains liquid refrigerant under high pressure. Overfilling of the storage cylinder may cause violent explosion. Do not disable the overfill safety protection of this machine. Always keep the cylinder on the load cell platform whenever the machine is operating.
- Only use cylinder which is supplied with this equipment or recommended by the manufacturer.
- Always use this machine in a well-ventilated area, avoid inhaling refrigerant and/or oil vapors, always read material safety instructions of refrigerant and oil packaging, for related warning and care.
- Always switch off the machine and disconnect power cable before removing any covers or servicing this machine, to avoid electric shock which can be fatal.
- Never use compressed air to test for leaks on vehicle or this equipment!
- Wear safety goggles and gloves, to protect eyes and skin from contact with refrigerant. Liquid refrigerant when it comes in contact with the human skin or eyes will cause frostbite and/or blindness. If accidental contact is made with eyes or skin, wash the affected area with plenty of fresh water immediately and contact a doctor if required.
- Avoid using the machine in very hot or flammable areas.
- Store the machine in a well ventilated cool area when not in use.
- Avoid using extension power cable thinner than 1.5mm² (10amp current carrying capacity).
- Keep gasoline or other flammable substances away from the equipment.
- ***For 1234yf machine, once a leak is detected in the unit, switch off the equipment by pressing the Emergency stop button and contact your distributor or service dealer.***

Component identification

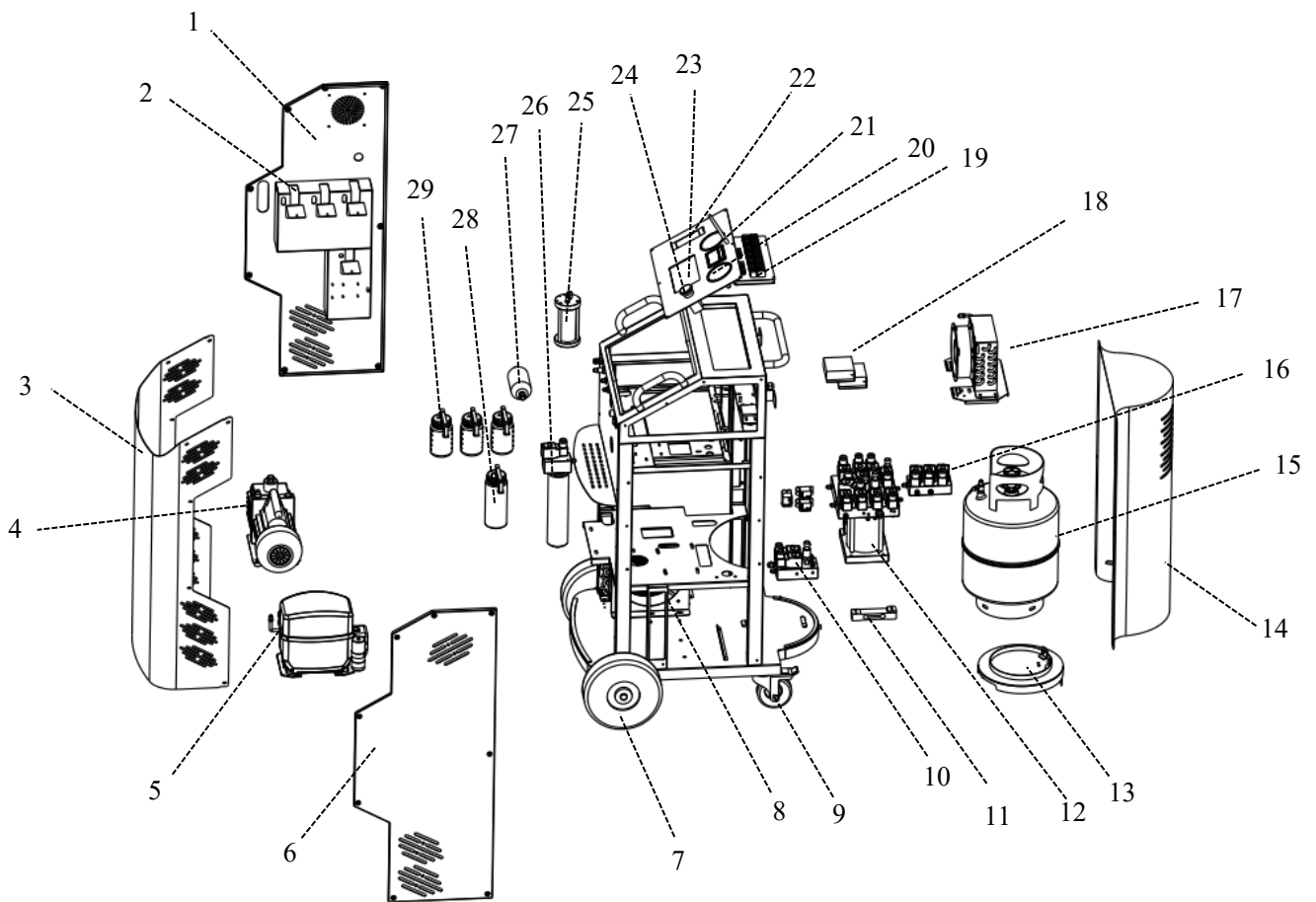

1	Left side cover	2	Oil load cell	3	Front cover
4	Vacuum pump	5	Compressor	6	Right side cover
7	Front wheel	8	Compressor ventilation fan	9	Rear wheel
10	Flush manifold and solenoids	11	Tank load cell	12	Oil separator manifold and solenoids
13	Tank holder	14	Rear cover	15	Refrigerant tank
16	Oil injection manifold and solenoids	17	Condenser and ventilation fan	18	Power supply
19	PCA	20	Manometer	21	Wifi antenna
22	Sight glass	23	Pad screen	24	Emergency button (1234yf only)
25	Flush oil accumulator	26	Main filter-drier	27	Oil vessel filter-drier
28	Recovered oil vessel	29	Oil and dye injection vessels		

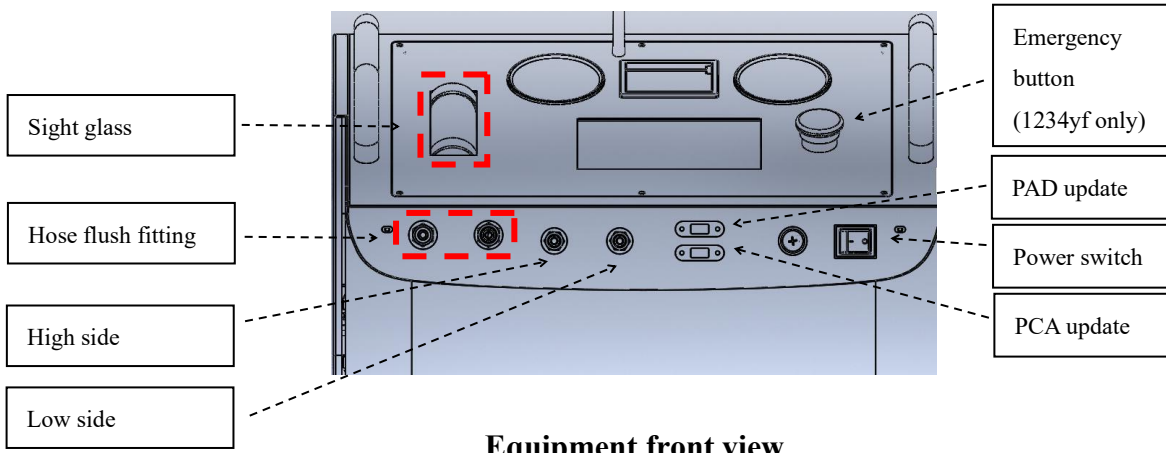

Equipment front view

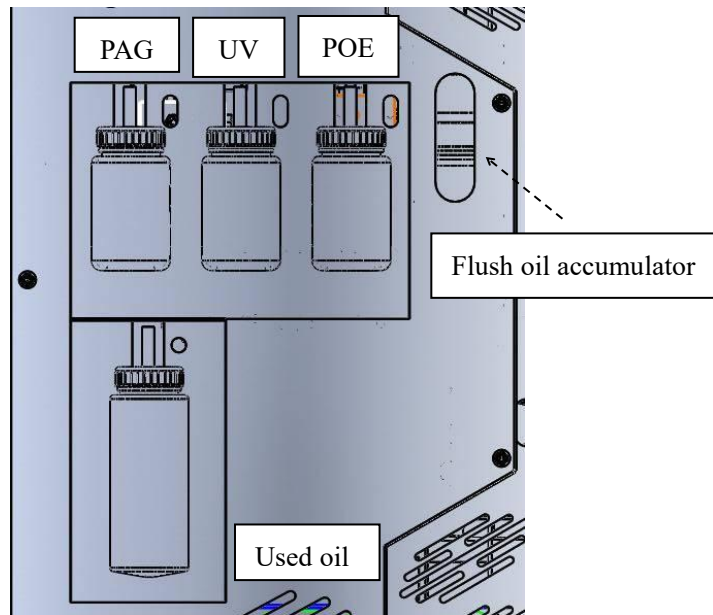

Left side view

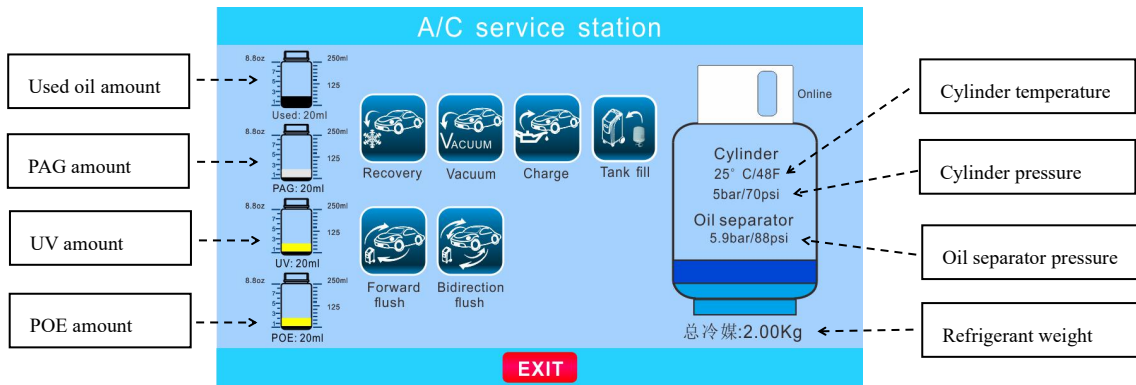

Operation interface

Function operation and description

Main functions	Recovery	Recovers and purifies refrigerant from automotive A/C system and it is then stored in to the machine internal storage cylinder for re-use.
	Evacuation	Removes air and moisture from the vehicle A/C system, with electronic vacuum leak detection test.
	Charging	Electronically charges the selected amount of refrigerant in to the vehicle A/C system
	Oil/dye injection	Electronically injects the pre-set or selected amount of oil and/or dye into the vehicle A/C system.
	Tank fill	Transfers liquid refrigerant from an external cylinder to the machine internal storage cylinder.
	Flushing	With this unique patented “pulsating forward and bi-directional” flushing system, the machine will flush out contaminated oil, moisture and foreign particles from the vehicle A/C system. When the technician selects forward flushing, the machine will pump high temperature and high-pressure refrigerant A/C system in the direction of normal refrigerant flow (the refrigerant flows with a pulsating action from the vehicle compressor low side to and recovered back from the high side during its cycle) or bi-directional flushing (refrigerant flows in both forward and reverse directions with a pulsating action). With the pulsating flushing function all compressor oil in the vehicle A/C system and foreign particles can be extracted, and then discharged into the used oil vessel.
	Fully automatic function selection	The machine will perform all the selected functions in a fully automatic sequence. The machine will stop automatically once all the selected functions or function have been completed.
	System. settings	Language
Calibration		Calibrate refrigerant cylinder load cell, oil vessels load cells, pressure transducer and temperature sensor.
Electronic air purge		Purges any non-condensable which may build up in the machine refrigerant storage cylinder. The machine will perform automatic non-condensable test and purges any air build up if required. This test is performed each time the machine is switched on.
Vehicle database		The machine stores a large number of vehicle makes and models, of the manufacturer recommended refrigerant and oil charge quantities, additional data can be added manually by the technician.
Operating record		The machine records and stores the operations the machine has performed; this data can be retrieved and also can be transferred to text file.
Unit settings		Selecting metric or imperial units of measurement.
Tare weight setting		Set empty refrigerant cylinder or refrigeration oil zero (tare) weight.

First operation

1. Unlock tank load cell

Unlock the load cell platform, by removing the safety locking **bolt** as shown below and save the bolt for future use.

PLEASE NOTE, whenever transporting the machine, re-fit the safety locking bolt to avoid damage to the load cell, when travelling on bad road surfaces.

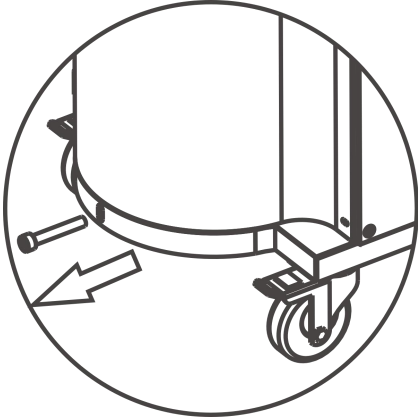

2. Tank fill

Use the adaptor fitting, to connect either HP or LP service hose (blue or red) to external refrigerant cylinder **liquid port** which you will be transferring the refrigerant from. If the refrigerant cylinder has only,

One valve and one port, invert the cylinder as shown below. If the cylinder has,

Two valves one port, leave the cylinder upright and open the liquid valve only, if the cylinder has,

Two valves and two ports, connect the adaptor to the liquid port, leave the cylinder upright and open liquid valve on the cylinder. Set the amount of refrigerant to be transferred into the machine storage cylinder, once the selected amount of refrigerant has been transferred, the machine will instruct the technician to close the liquid valve on the storage cylinder.

The machine will then recover the refrigerant left in the service hose which is connected to the transfer cylinder and it will then stop automatically. For more details please refer to “Tank fill” in the operating procedure chapter.

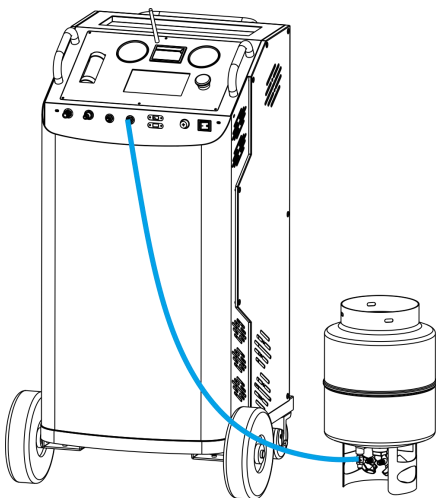

Operating procedure

Recovery function

For HFO-1234yf system, refrigerant identification is firstly processed if the machine is equipped with internal refrigerant identifier, if not fitted with a refrigerant identifier, it will remind the technician to process such identification with separate identifier. Only when the purity of refrigerant is above 98% the recovery is allowed or should be allowed to proceed.

Check and empty the used oil vessel before the recovery process is initiated.

The recovery process removes refrigerant from the vehicle A/C system, until a vacuum is reached. During this process, the refrigerant is purified from any moisture, oil and foreign particles. The processed refrigerant is then stored in the internal storage cylinder of the machine, ready for re-use. If any oil is recovered during this process, the oil will be discharged into the used oil vessel. The amount of oil if any, will be displayed and recorded. After the first recovery has been completed, the machine will pause for 3 minutes, to check if there is any refrigerant left in the vehicle A/C system. Recovery will start again automatically if there is a pressure rise during the 3-minute pause. At the completion of recovery re-run, the machine will display and print the total amount of refrigerant recovered and oil if any.

Note: The amount of refrigerant recovered of each operation is monitored and recorded, for filter-drier life expiration monitoring. The machine filter-drier is capable of purifying up to 100KG of recovered refrigerant with average contamination (refrigerant cylinder filling is not included in the filter life calculation), and upon reaching the filter-drier life expiration the machine will not be able to be powered up before the machine is serviced (filter-drier change, calibration, vacuum pump oil change and o-ring/washer change etc.) and reset.

Note: If the machine stops recovering during the function and displays **high pressure**, it may have excessive air build up in the storage cylinder, storage cylinder valves may have been left partially or fully closed, condenser cooling fan not working or machine may be used in an extremely hot environment.

Evacuation function

Select “**Vacuum**”, evacuation is performed to remove air and moisture from the vehicle A/C system, ready for oil injection. evacuation time can be set from 2 to 240 minutes, and vacuum leak test time can be set from 0 to 30 minutes.

Refrigerant charging function

In Charge function, oil injection (if selected) and refrigerant charging are processed. Either PAG or POE can be selected to be injected, with the amount set by technician or selected via the database. UV injection can also be selected. Oil/UV injection is processed through the high side. Refrigerant charge amount can be set by the technician, or by selecting car make and model in the database. Refrigerant can be charged through high side, low side or high and low side.

Note, vehicle A/C system should be switched on and engine running when charging through the low side of the vehicle A/C system.

Note, if charging is selected from high and low side simultaneously, care must be taken. After charging function is completed and before starting the engine and switching on the A/C system, turn the compressor hub several times by hand to expel any liquid refrigerant that may have accumulated in the compressor compression chambers during the charging process. **Not performing this process can damage or destroy the compressor.**

When oil/UV injection is selected, evacuation function must be performed first. If the vehicle A/C system is not in a vacuum state, oil or dye injection can not be performed and the machine will display a warning.

Hose flush, if hose flush is selected (highly recommended), the process will flush the oil from the wall of the service hoses and internal pipelines, to make sure the new oil to be injected is not contaminated with the previous oil injected. This process will take about 5 minutes.

Pre-charge leak test, if selected, after around 15% of total amount of refrigerant selected is charged in to the vehicle A/C system, the technician is asked to perform a leak test with a reliable electronic leak detector. If no leaks are detected, the charge function can be completed by charging the remainder 85% of refrigerant selected. Otherwise, the process should be stopped to fix the leak.

Hose purge, hose purge is selected in charge function (default), to charge the full amount of refrigerant selected. Some refrigerant will be left in the discharge hose (high side service hose) either at charge function or at A/C diagnosis with vehicle A/C on. Follow the instruction displayed on the touch screen to purge the remainder of refrigerant left in the discharge hose into the vehicle A/C system. This will make certain that 100% of the selected amount of refrigerant is fully charged into the vehicle A/C system.

Tank fill

For HFO-1234yf system, refrigerant identification is firstly processed if the machine is equipped with internal refrigerant identifier, if not fitted with a refrigerant identifier, it will remind the technician to process such identification with separate identifier. Only when the purity of refrigerant is above 98% the recovery is allowed or should be allowed to proceed.

Select **Tank fill** to fill or add refrigerant into machine storage cylinder. It is recommended to maintain 5-10 kg refrigerant in the machine internal cylinder at all times, to guarantee better charging and flushing operations. During the refrigerant cylinder filling process and once the selected amount of refrigerant has been transferred, the machine will display to the technician to **close hand valve on the external cylinder**, the machine will then recover the rest of refrigerant which is left in the transfer service hose and internal pipelines.

If the sum of volume of refrigerant in the internal cylinder (for example, there is already 10kg in the internal cylinder) and the tank fill value (for example, tank fill set at 4kg) exceeds 14KG (80% or 18KG, internal cylinder allowable maximum capacity), the machine will not proceed with the selected operation and an alarm will be displayed.

Please note: The amount of refrigerant which is transferred from external cylinder to internal cylinder is not calculated on the filter expiration life duration.

Flushing function

Please note, empty used oil vessel before starting this operation.

For HFO-1234yf system, refrigerant identification is firstly processed if the machine is equipped with internal refrigerant identifier, if not fitted with a refrigerant identifier, it will remind the technician to process such identification with separate identifier. Only when the purity of refrigerant is above 98% the recovery is allowed or should be allowed to proceed.

Flushing function is performed to completely extract compressor oil from A/C system, thus all contaminants such as acidified substances, moisture and other foreign particles in the vehicle A/C system will also be extracted.

Forward and bi-directional flush can be selected. Forward flush means charge liquid refrigerant from A/C low side and at the same time recover from the high side with pulsating action (same as A/C normal flow). Bi-directional flush means during flushing function, refrigerant flows in forward direction and reverse direction (reverse direction means charge from high side and recover from low side, in reverse from normal A/C flow), each direction lasts certain period of time. Flush time can be set corresponding to refrigerant amount in system. For example, A/C system with 500g refrigerant, flush time is recommended to be set at **30 minutes**, while **60 minutes** can be set for system with 1kg or more refrigerant. Flushing refrigerant will be recovered and purified automatically, at the end of the flushing process and stored in to the storage cylinder, ready for re-use.

Bi-directional flush is more efficient in extracting compressor oil than forward flushing, especially for dual A/C system.

For some A/C system equipped with evaporator solenoids or electronic expansion valves, which are normally closed when the vehicle A/C is off, it is recommended to activate the solenoid and TX valves with proper diagnostic scanner or remove and bridge these valves with the appropriate bridging fittings. Not performing the above, refrigerant flow is restricted and flushing efficiency can be affected.

For multi-flow condenser, the oil in the condenser may not be flushed out completely.

Note: Instead of counting whole amount of refrigerant recovered after flush (large amount of liquid refrigerant is charged into A/C system from equipment internal cylinder), and the same amount of refrigerant will be recovered in to equipment cylinder after flushing is completed. The recovered amount is displayed on the screen at end of the operation. For filter-drier life, the machine will only calculate the refrigerant amount difference between pre-flush and after-flush for filter-drier life (this amount is not displayed on screen).

Automatic function mode

Please note, empty used oil vessel before starting this operation.

In automatic function mode, the machine runs recovery, evacuation, vacuum test if selected, oil injection, dye injection and refrigerant charge in sequence, with data of each operation preset by technician.

System setting

Input password 111111 to enter “System. Setting”. In system setting, Language, Calibration, Air purge, Database, Operation record, Unit set, Empty container weight set, Component testing and owner information will be displayed or reconfigured.

Calibration: Even though the machine is equipped with calibration weight for quick and easy calibration, it is recommended to have professional technician only to perform calibration of load cells, pressure transducer and temperature sensor. To access calibration, special password is needed. Please contact your equipment supplier or manufacturer, to receive the special password.

Warning: *Not calibrating the machine correctly can have serious consequences on the machine and/or vehicle A/C system.*

Air purge: Each time the machine is switched on, it will purge air (non-condensable) automatically if necessary, based on the pressure-temperature nature of refrigerant. Also, the technician can purge air (non-condensable) any time manually by accessing “Sys. Setting” - “Air purge”.

Database: The technician can access database of refrigerant, oil volume of different car makes and models. If the technician can not find information of some car model in the database, they can add such information manually. Once a car model information is added, in future such information will be displayed while the technician selects “charge through database” in “charge” function.

Unit settings: To set metric or imperial unit of measurement.

Empty container weight set:

The total load cell reading equals the sum of empty container weight and net refrigerant/oil content value. Thus, increase/decrease empty container weight, can correspondingly decrease/increase refrigerant/oil value displayed in the main operation interface.

Component test:

The technician can activate and deactivate different electrical component of the machine. This is for quick and easy diagnosis and troubleshooting.

Please note:

Only qualified technician (with special password) is allowed to access this function, not performing this test correctly could cause damage to the machine or injury to the operator.

Operation record:

Machine operations are recorded and saved, the technician can access this information.

Note: *Contact the distributor or manufacturer to receive a dynamic matching code to access this function.*

Owner information:

The technician can change password and input their company name and contact information in this function. Please remember well your new password, or the use of the machine will be restricted. The contact information you input will be automatically printed, when you select “print” after any function or service job is completed.

Machine Maintenance

Changing solenoid plunger or spool seals

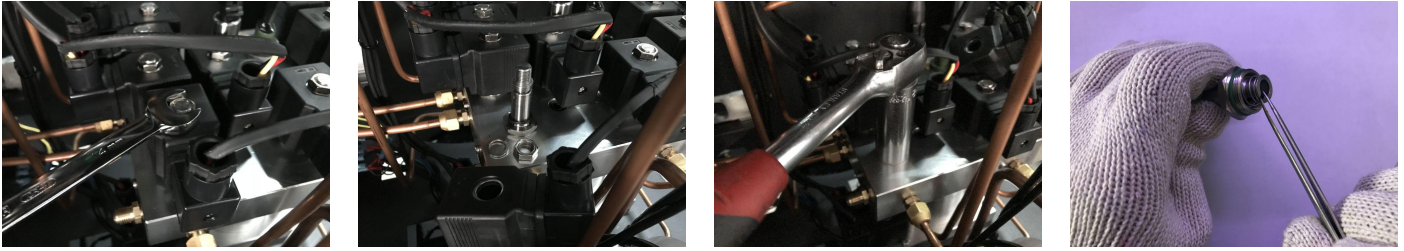

Vacuum pump oil change

It is recommended to change vacuum pump oil every time you change filter-drier. By removing front cover, you will have easy access to vacuum pump oil drain port, beneath the pump. After draining the old oil, re-fill the vacuum pump with new oil. Note the level line at the side of the vacuum pump, to fill proper quantity of oil.

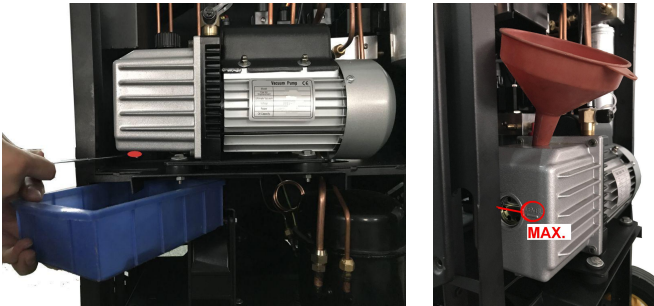

Main filter-drier replacement

Once a total of 100KG of refrigerant has been recovered, the machine automatically shuts down and reminds the technician to replace the filter-drier. It is recommended to service the machine at your convenience after a total of 100KG of refrigerant has been recovered.

After you input password to access Air-095 app, you can select “change filter-drier” when the following interface is displayed, see below,

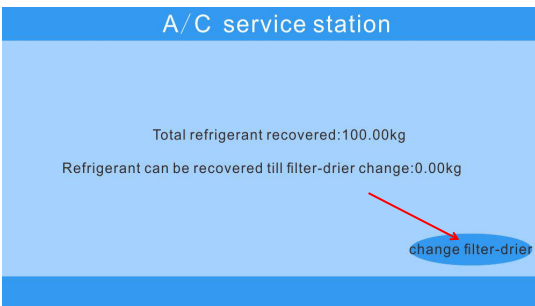

The machine will display to input dynamic matching code (Please contact your equipment distributor or manufacturer to receive the code), as following interface:

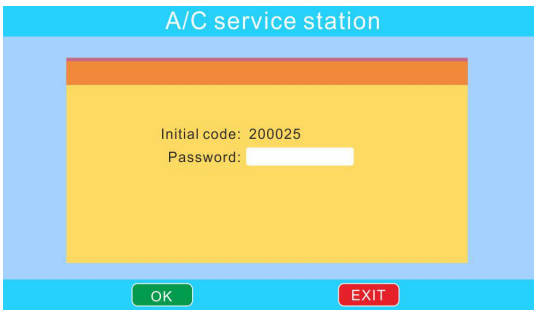

Then you are asked to input filter-drier code (each filter-drier from the factory has an individual code) in the following interface:

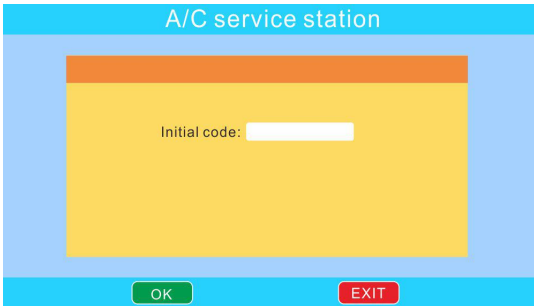

DO NOT press “Reset service interval time” button at the following interface.

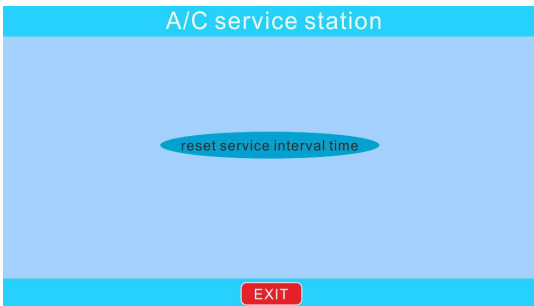

Please remove front cover and change filter-drier, drain and re-fill vacuum pump with oil, see images below, press “Reset service interval time” button.

1.Remove screws and remove front cover.

2.Change filter-drier.



Cleaning before installation

The filter-drier and vacuum pump oil replacement, is now completed. When you re-enter Air-095 app you can see the amount of refrigerant left to be recovered (100KG).

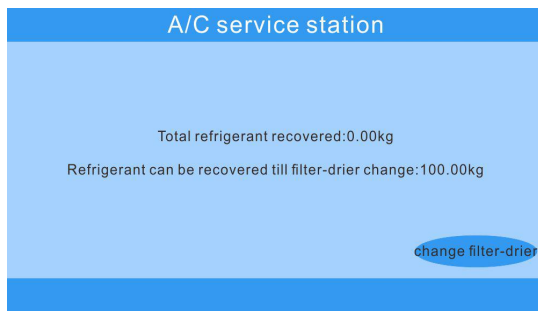

Compressor oil change

Remove the recovery compressor from the machine by removing the suction and discharge pipes as shown below. Remove the 4 mounting bolts which fix the compressor to the chassis as shown below. Drain the oil from the suction port (from where the larger pipe was connected) by inverting the pump as shown below (drain oil) Add 480ml refrigeration oil as shown below. Re-fit compressor and pipes. Pressurize system and make leak test connections. This can be achieved by charging refrigerant in to the service lines, then select recovery and run recovery for 5 seconds and stop. This action will pressurize the internals of the machine, including the two pipes which were disconnected from the recovery compressor. By using a good reliable leak tester or soapy solution around the recovery pump fittings, you will be able to check for any possible leaks.

Remarks: *Compressor oil change is recommended if machine is used often for flush. Otherwise it is not a must for compressor oil change.*



Remove pipes and screws



Drain oil



Add oil

Oil vessel filter-drier replacement

Oil vessel filter-drier isolate the new oil vessels (PAG/UV/POE) from moisture in the air. It is recommended to replace oil vessel filter-drier every time the machine is maintained. You can also replace the oil vessel filter-drier when the color inside vision window "Oil vessel humidity" changes from green to yellow.

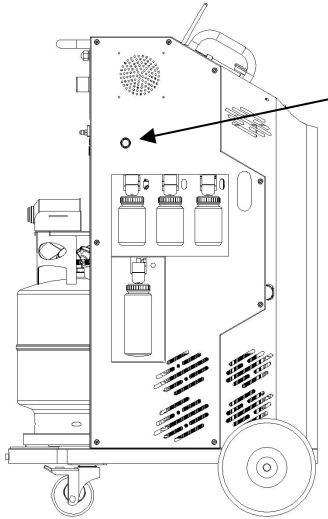

Locate the oil filter
drier and replace it

Calibration of load cells, pressure transducer and temperature sensor.

We suggest that only well-trained technicians gain access to the calibration and machine troubleshooting program. Please contact your distributor or manufacturer if you require assistance.

A calibration weight of 1KG is supplied with the machine.

Caring for your equipment

- Keep your equipment clean and well maintained at all times.
- Keep service hoses stored on the storage adaptors when not in use, to avoid dirt and dust contaminating the internals of the couplers which will then end-up in the vehicle A/C system, which can cause serious system malfunction.
- Always clean vehicle A/C system service ports before connecting machine quick couplers on to the service ports.
- Keep the system stored in a clean area and away from direct sunlight and artificial heat source, when not in use.
- Perform regular services on the system as recommended by the manufacturer. Ignoring and skipping services will deteriorate the integrity of the machine.
- If the machine is used on badly contaminated A/C systems frequently, it is recommended that more frequent vacuum pump oil changes are made and main filter replacements are performed. Contaminated vacuum pump oil will cause the vacuum pump to corrode badly internally, which eventually the vacuum pump will fail. Contaminated main filter will diminish the refrigerant purity.
- Do not bump or move the machine when the technician is in the process of charging a vehicle, this can affect the charging accuracy.
- If the machine is bumped or knocked down accidentally, check the calibration and that there are no leaks internally.
- **DO NOT** use compressed air to test for leaks.
- If the technician is not sure on the correct way of operating the machine, please do not hesitate to contact your distributor or manufacturer. We always like to help you.

Packing list

Serials Number	Name	Amounts	Package
ZT010044	AIR-095 main unit	1	
BZ030017	3m red service hose	1	
BA030016	3m blue service hose	1	
BZ130028	HP quick coupler	1	
BZ130029	LP quick coupler	1	
DZ160033	30A fuse	1	
DZ180034	Update cable with USB	1	
WJ010007	HP/LP block cap	2	
BZ040011	Sight glass	1	
YS050014	Dust proof cover	1	
BZ130034	1KG calibration weight	1	
Varies for different market	Tank fill fitting	1	