

ieGeek

Floodlight Security Camera



Official Email: service@iegeek.com



CONTENT

After-sale Support.....	1
Packing List	2
How to Add Floodlight to APP	4
1. Download 'CloudEdge' APP.....	4
2. Register Account.....	5
3. Power on Floodlight.....	5
4. Connect Wi-Fi	5
5. Remove the power Plug	7
How to Add Camera to APP	8
1. Turn Off the Power at the Circuit Breaker (not switch).....	9
2. Install Bracket	10
3. Hang Floodlight Camera.....	10
4. Connect the Wires.....	11
5. Put the Camera on the Wall	13
6. Turn on the Power at the Circuit Breaker.....	14
Function Introduction	15
Light Settings	16
Device Sharing	17
SD Card Recording.....	17
FAQs.....	18

After-sale Support

Thank you for purchasing our ieGeek Outdoor Floodlight Security Camera . We provided 12 months warranty. If you have any problems or suggestions, please feel free to contact us by Amazon message or send e-mails to our official mailbox (service@iegeek.com). The best customer service will be offered to you.

Note:

- . The camera only supports 2.4GHz WIF), it doesn't support 5GHz WIFI.
- . Please ensure that the Wi-Fi signal strength is to be over than 85%; if the camera is far away from the signal source, it won't be connected successfully for the first time.
- . If your router is connected with too many devices, the camera will fail to connect Wi-Fi because of the IP address conflict.
- . This wireless camera does not support PC Browser and Software.
- . This wireless camera supports events recording when Wi-Fi disconnected.
- . Video playback works in CloudEdge APP only. It does not support the 3rd party player.
- . Manually snapshot and recording files are saved in mobile. Events snapshot files are saved in Cloud. Events recording files are saved in Micro SD card.
- . It will consume. the batteries' power. if you watch live footage or the recorded videos from the SD card.

Packing List

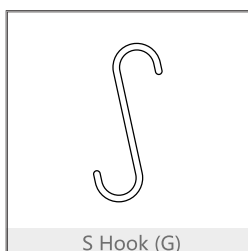
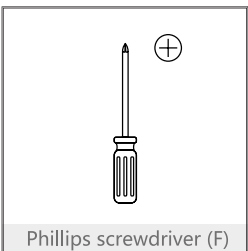
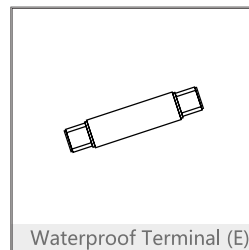
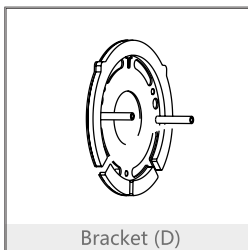
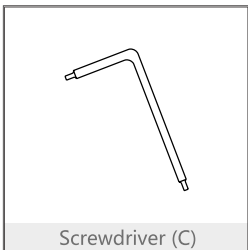
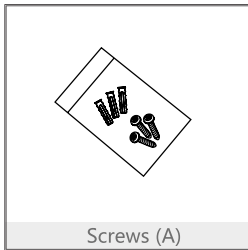
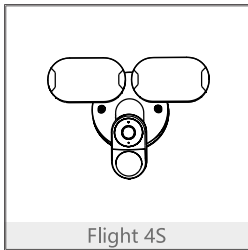

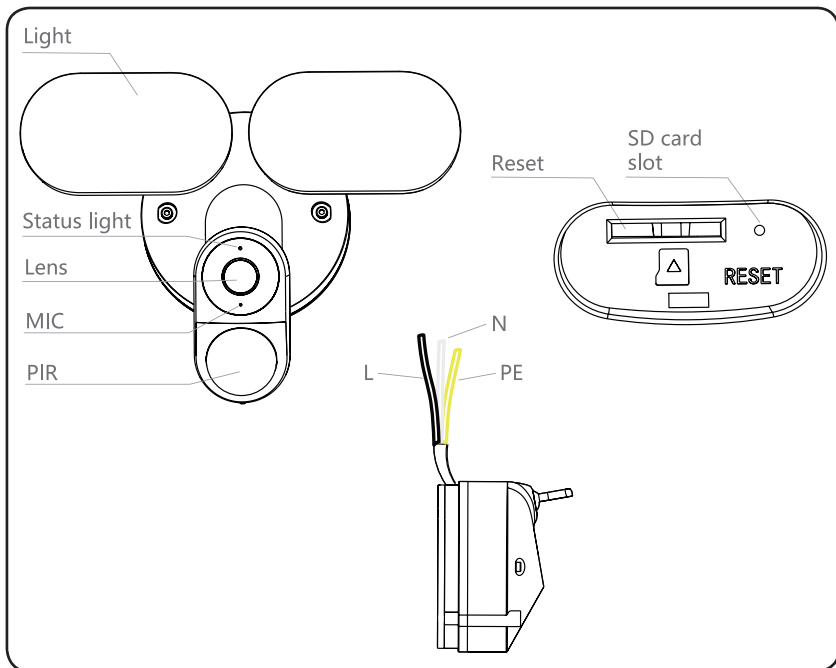

Power	AC 100~240V
Status Light	Solid red light on: the camera network is abnormal Blinking red light: awaiting Wi-Fi connecting Solid blue light on: camera running correctly Blinking blue light: currently connecting
Microphone	Captures sounds for your videos
SD Card Slot	Supports local SD card storage (max. 128G)
Reset Button	Press and hold the RSET for 5 seconds to reset the device (if you have modified settings, they will return to factory defaults)
Light	Turn the light on/off manually or automatically

How to Add Floodlight to APP

1. Download 'CloudEdge' APP

Search "CloudEdge" in App Store or Google Play, or scan the following QR Code to download and install on smart phone.



NOTE: Please turn on 2 permissions below when using the App for the first time.

- 1) Allow 'CloudEdge' to access mobile cellular data and wireless LAN, **or it will be failed to add IP camera.**
- 2) Allow 'CloudEdge' to receive pushed message, **or the cellphone will not receive alarm push when motion detection or audible alarm is triggered.**

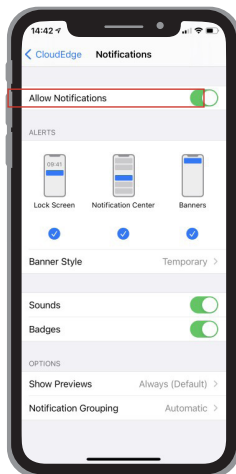
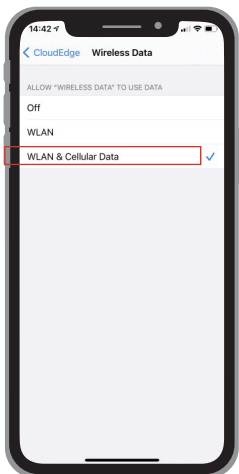

2. Register Account

New users need to register by e-mail. The concrete steps are as following:

- 1) Click 'Register';
- 2) Follow the steps to complete the registration of the account;
- 3) Log in.

Tips:

- 1) Please use correct email;
- 2) Please choose correct country code;
- 3) When registering a new account, please choose the region which you are actually in. (Different registered regions can't share the camera.)

3. Power on Floodlight

Insert the power plug of the floodlight camera into the power port, and the product work indicator will light up.

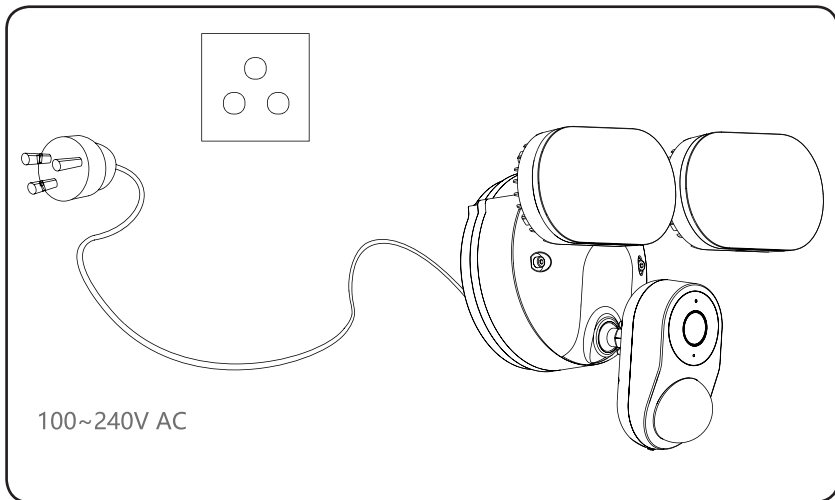

4. Connect Wi-Fi

- 1) Put floodlight camera and smart phone to the router within 1 to 3 feet (30 to 100 cm) to connect Wi-Fi.

NOTE: The camera only works under 2.4G Wi-Fi, not supports 5G Wi-Fi.

- 2) Run 'CloudEdge' App, Click  and select "Floodlight Camera".
- 3) Follow the instructions to ensure that the camera is activated. (The indicator light is turning red and flashing slowly.)
- 4) Select 2.4Ghz Wi-Fi SSID and input password, tap "Next"
- 5) Choose "QR Code Configuration". Align the QR code with the camera lens in the distance of 15cm until the QR code is recognized. After hearing the sound 'Bugu', tap 'Next'.
- 6) After clicking 'Next', the camera will start connecting Wi-Fi. When connection finished, the app will skip to 'Device Found' page, and you can edit the camera name. Then click 'Done' to switch to My Device List, now you can watch real-time video.

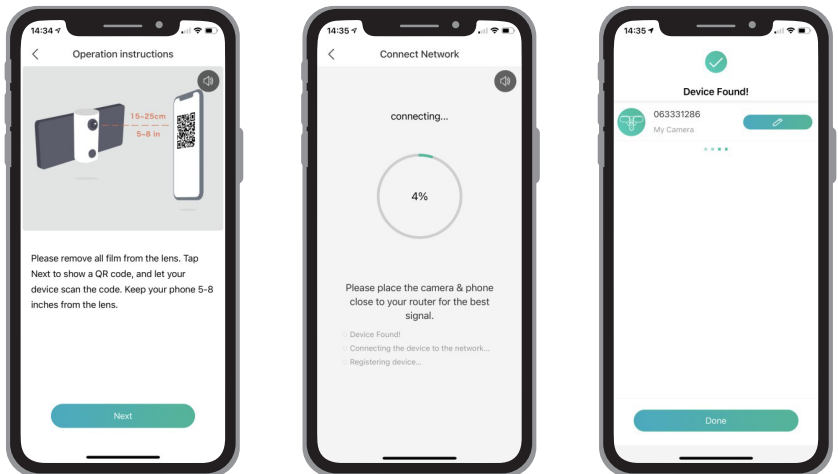

How to deal with if there is any problem with WI-FI connection?

- 1) Please ensure that you have used 2.4GHz WI-FI. According to our experience, the reasons for the failure of WI-FI connection from most users are the wrong Wi-Fi format selection and the

wrong use of 5GHz WIFI to add the camera.

- 2) Make sure you use correct Wi-Fi password and smooth network speed.
- 3) Be sure you scan the QR code according to the instructions.
- 4) Restore the product to factory settings, restart the router, and add it again.

5. Remove the power Plug

Finished Wi-Fi configuration, please unplug the power plug and remove the wire from the other end of the power plug from the waterproof terminal (E).

- 1) Unscrew the cap on the waterproof terminal counterclockwise corresponding to the end of the power plug.
- 2) Use a screwdriver (F) to loosen the three screws on the waterproof terminal. Note: Do not remove the screws.
- 3) Pull out the entire power plug cord from the waterproof terminal.

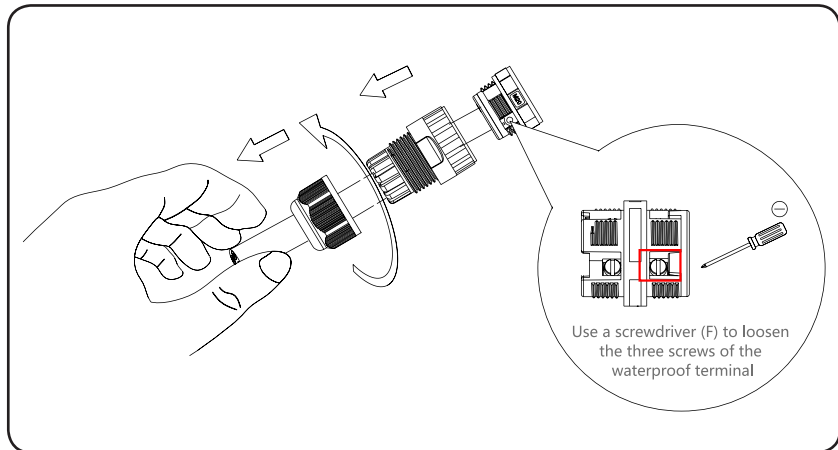

Use a screwdriver (F) to loosen the three screws of the waterproof terminal.

How to Add Camera to APP

Note: Without professional guidance, it is not allowed to disassemble or replace any part of the product. This manual is for reference only. Unless proper safety measures are taken, working with electricity is dangerous. We recommend that you hire a licensed electrician.

Recommended Installation Height: 8-10 feet above the ground, at this height, the sensor will provide a detection distance up to 35 feet.

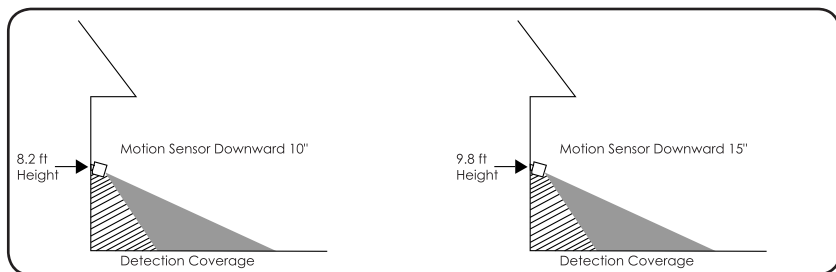

To get the best coverage area, you could adjust the vertical angle of the camera to an appropriate angle.

Tools Needed:

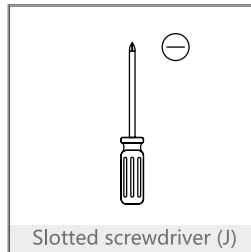
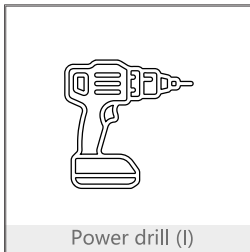
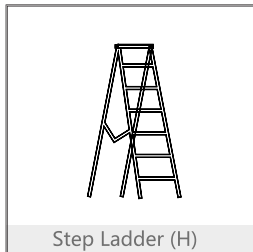

Note: In order to obtain the best product performance and avoid unnecessary environmental interference, please pay attention to the following during the installation:

- 1) Do not install the product near a heat source, such as, an air conditioner outdoor unit, a trigger exhaust vent, etc.
- 2) Ensure that there is no reflector within 5 feet of the PIR sensor, otherwise, it will interfere with the normal function of the sensor.
- 3) Do not face the camera to a high-power LED light directly, which may cause image flickering.

Tip: The use of electricity is dangerous. The product is recommended to be installed by a qualified electrician.

Follow the steps below to install the floodlight camera:

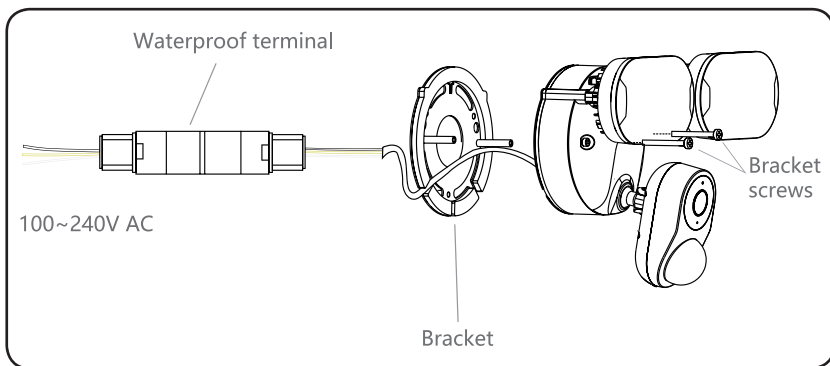

1. Turn Off the Power at the Circuit Breaker (not switch)

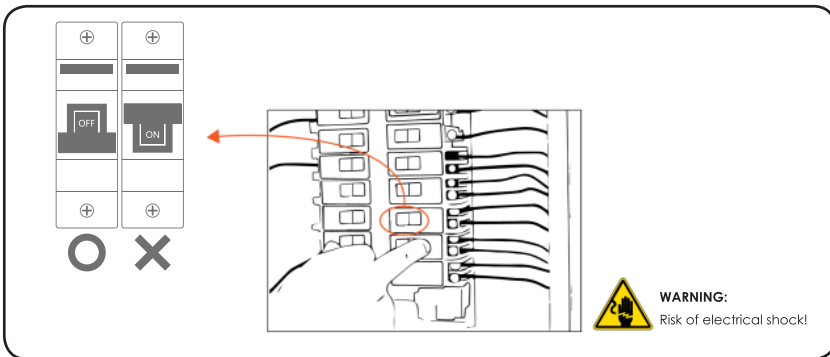

Electricity is dangerous. The power must be cut off before installing the product.

Note:

- 1) Please make sure the power supply voltage is AC 110-240V.
- 2) Appropriate grounding device.
- 3) Do not connect this lighting device to a dimmer switch or timer.
- 4) When having wired installing connections, please always follow the norms and standards.
- 5) Do not install near flammable or combustible surfaces.

2. Install Bracket

The floodlight camera must be installed on the wall near the UL approved junction box. The two sharp corners on the metal bracket must face up symmetrically.

Tip: If your home does not have a junction box, this product can also be installed near the wall with neutral/fire/ground outlets. Also, you could seek help from an electrician.

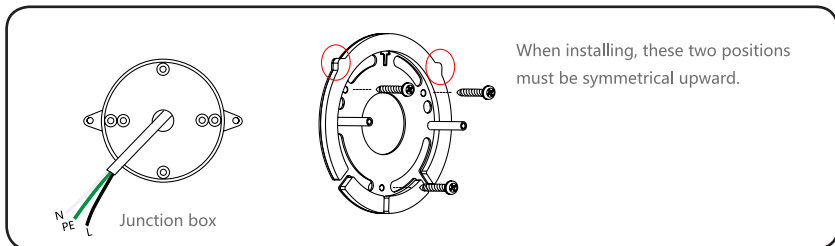

3. Hang Floodlight Camera

Before connecting the wires, use the hook (G) provided in the product box to lift the floodlight camera from the bracket. This step is convenient for freeing your hands when connecting wires in the next step.

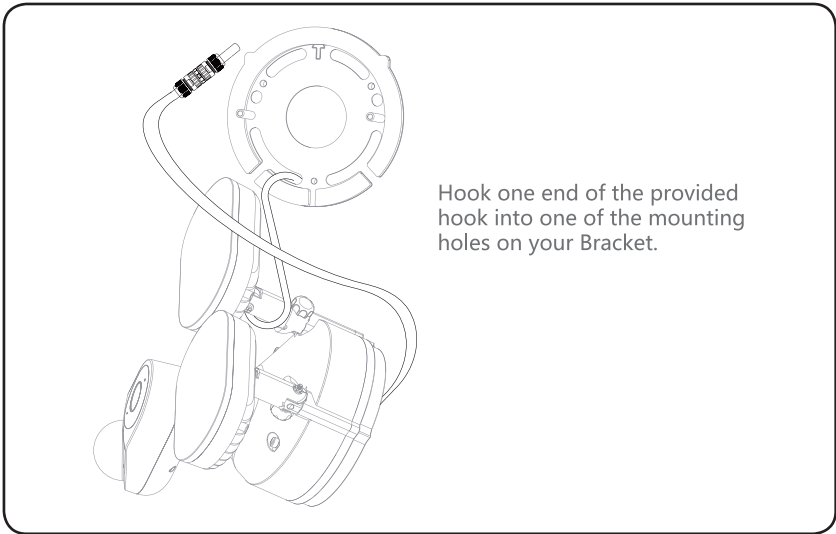

Hook one end of the provided hook into one of the mounting holes on your Bracket.

4. Connect the Wires

Connect the three wires in the junction box to the waterproof connector of the floodlight camera.

Remove the outer packaging layer of the wires and remain colored wires not exceed 17mm. The stripped part of each colored wire shall not exceed 5mm. If the length is not up to the standard, it cannot be installed.

Note: Make sure that each of three wires is correctly connected as following picture during the wiring. Otherwise, the product has the risk of burning.

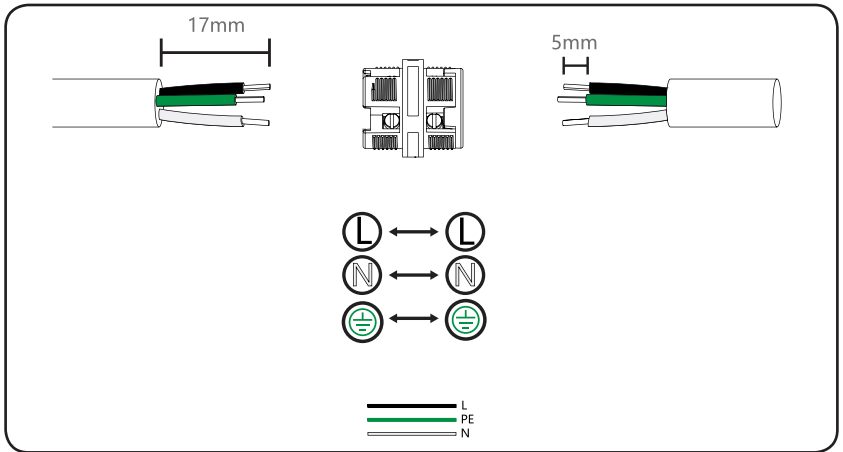

- 1) The three wires must pass through the sponge ring of the waterproof terminal. This operation is to ensure the waterproof performance.
- 2) Connect the white wire (neutral line N) into the N hole of the waterproof terminal, and tighten it with a screwdriver (F).
- 3) Connect the black wire (live wire L) into the L hole of the waterproof terminal and tighten it with a screwdriver (F).
- 4) Connect the green wire (ground wire PE) into the ground wire PE hole of the waterproof terminal, and tighten it with a screwdriver (F).
- 5) Tighten all the waterproof terminals to achieve the waterproof effect.

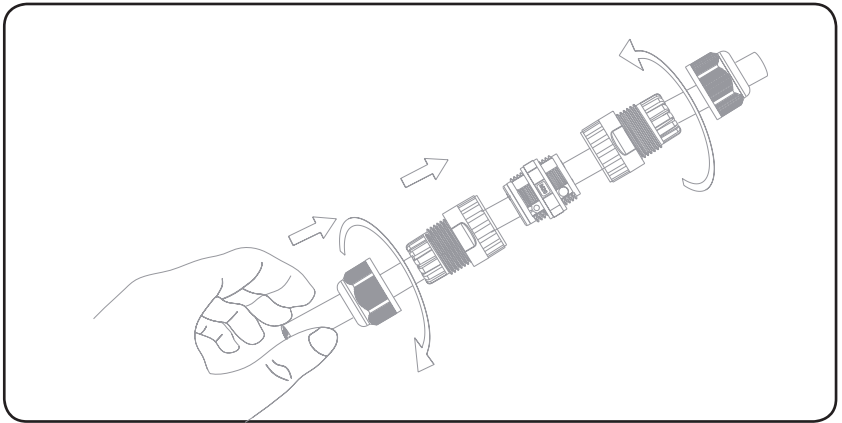

5. Put the Camera on the Wall

- 1) Align the base of the floodlight camera with the two cylinders on the metal bracket, insert the bracket screws (B) into the two screw holes on the product, and then use the hexagonal screwdriver (C) to fix the screws.
- 2) Refer to the picture below to adjust the angle of the LED. The camera is perpendicular to the horizontal ground. Adjust the downward tilt angle appropriately according to the height of the camera installation. It is recommended to tilt down 15 degrees.

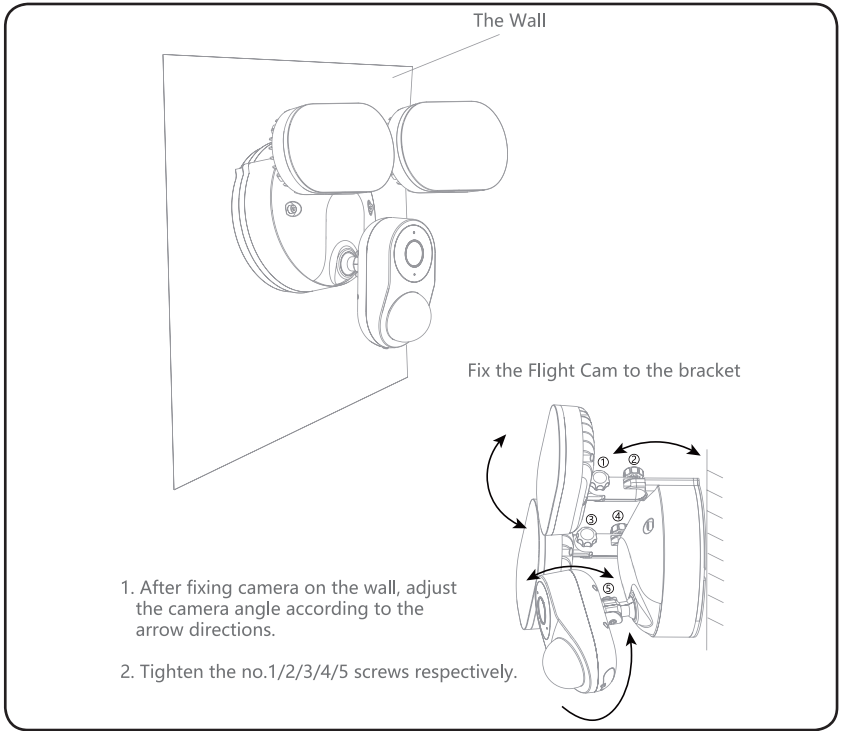

6. Turn on the Power at the Circuit Breaker

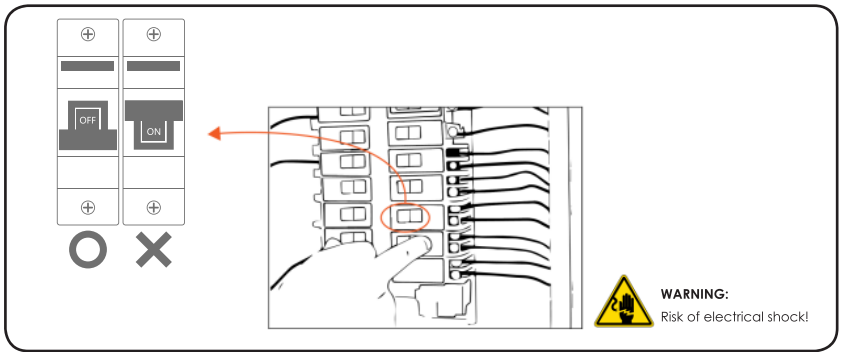

Observe whether the working status light of the floodlight camera is on. If it is not, it means that the camera has failed to energize. There may be the following reasons:

- 1) The wires in the junction box are not energized. They are invalid wires.
- 2) The three wires of the neutral wire, live wire and ground wire are connected in wrong sequence.
- 3) The three wires of neutral wire, live wire and ground wire are in poor contact with the waterproof terminal.

Please turn off the power of the circuit breaker immediately and troubleshoot the problems one by one.

Function Introduction

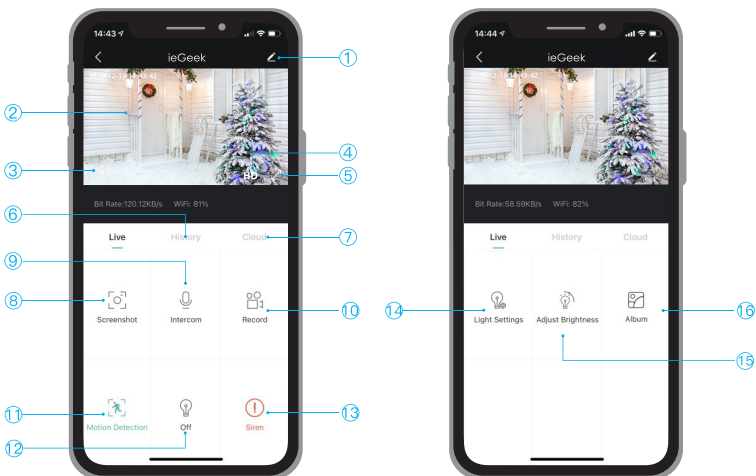

1. Parameter settings (alarm settings, video, lighting, equipment information, firmware upgrade, etc.)	2. Real-time video screen
3. Turn on/off the microphone	4. Picture Clarity setting (SD, HD, FHD option)
5. Full-screen display	6. SD card video playback
7. Cloud storage video playback	8. Manually Screenshot
9. Voice intercom (press and hold to talk)	10. Manually capture video clips
11. Turn on/off the alarm	12. Turn on/off the LED light
13. Turn on/off the siren alarm	14. Light settings (PIR linkage control, lighting plan)
15. LED light brightness adjustment	16. Album (store screenshots and manual video files)

Light Settings

①



②



- 1) Motion for Lights: Set the PIR detection sensitivity. Under the night environment, the LED lights are on when PIR sensor detects moving objects.
- 2) Light Schedule: The LED lights are always on during the set time period.

Adjust Brightness: Support LED brightness 7-level adjustment

Device Sharing

How others access the Floodlight Camera?

Realize this function through 'Device Share'.

- 1) Invite your friends to download and install 'CloudEdge' APP and log in.
- 2) Click 'Device Share' icon to watch operation video, and follow the steps to finish share device.

Tips: When you have a sharing, please make sure the APP account is registered in the same regions. Otherwise, you won't share successfully.

SD Card Recording

The SD card is not included. Please purchase it by yourself if you need SD card to store files.

Requirements for SD card

- 1) It is recommended to use San Disk, Samsung and other brand cards;
- 2) Support 2-128GB capacity;
- 3) It is recommended to use standard Class 10 SD card;
- 4) Only support FAT32 format.

Note: Inserting a memory card into the SD card slot of the floodlight camera, the floodlight will automatically start saving video. You can set event recording or full day recording.

How to watch the video in the SD card:

- 1) Click 'History' or 'video playback' button of alarm information icon in the APP to enter the video playback interface. Drag the time axis or select the alarm point to find corresponding time period recording that you need.
- 2) Insert the SD card into the computer. The video files are MP4 format. You could directly use the player to play the video.

FAQs

The device prompts offline?

- 1) Check whether the equipment is in the power-on state, and observe whether the working indicator of the equipment is on normally.
- 2) Check whether the WIFI network is in good condition and restart the router.
- 3) If the device is located far away from the router, which results in the inability to obtain a good WIFI signal. It is recommended to move the router to a closer place or add a WIFI amplifier to improve the WIFI performance.
- 4) Delete the floodlight camera from your CloudEdge account and add it again after resetting the device.
- 5) Check whether the device firmware and application are the latest version.

Update router or WIFI password?

Delete the floodlight camera from your CloudEdge account. After resetting the device, use the new WIFI or password to add it again.

Can't play historical video?

- 1) Check the SD card status in "Settings" to ensure that the SD card has been identified successfully .
- 2) Re-insert the SD card.
- 3) Format the SD card in the application.
- 4) Try another new SD card.

Alarm push frequently?

- 1) In the app, lower the sensitivity of the motion detection alarm.
- 2) Set the alarm area and control the alarm monitoring range within you need.
- 3) Turn on "Alarm when only people appear" to use humanoid

algorithm to filter useless alarms.

The phone cannot receive the alarm push?

- 1) Turn on the push permission of the "CloudEdge" APP in the phone system.
- 2) Ensure that the device's motion detection is turned on successfully .
- 3) Restart the phone. Try to clear the cache if you phone is Android system.
- 4) Check whether the network is good.

The LED light turn on frequently at night?

In the application-"Motion for Lights", lower the PIR monitoring sensitivity.

The LED lights are always on?

- 1) Check whether the 'LED' button in the APP is turned on.
- 2) Check whether there is a problem with the time setting in the 'Light Schedule'.

