

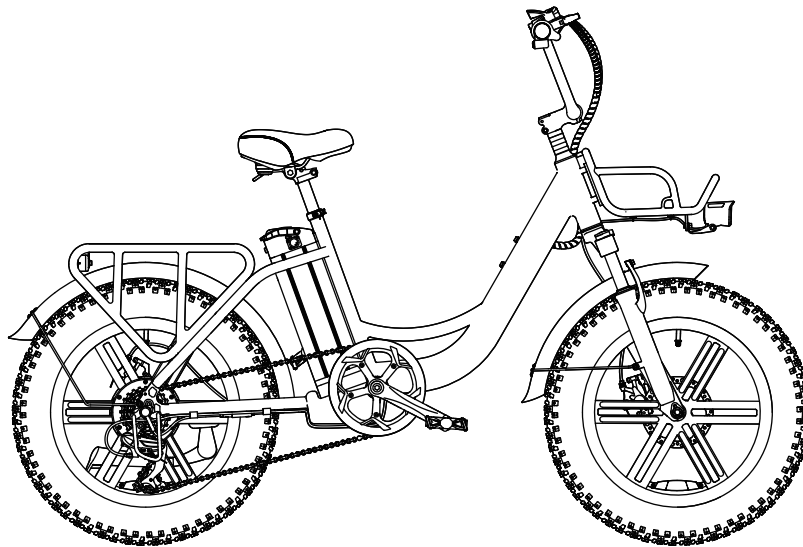

ENGWE

L20 BOOST



CAUTION READ THIS MANUAL BEFORE USING YOUR EQUIPMENT

Safety Guidelines for E-Bike Usage

Thank you for choosing the ENGWE series product. To ensure a quick and safe riding experience, please familiarize yourself with this manual. The company reserves the right to interpret and explain this manual.

1. Before using this product, ensure the rider has read the manual
2. It is your responsibility to be aware of and comply with the laws in your area.
3. Before riding, thoroughly check that all components are in good condition to ensure safety. If you find any problems, please contact us in a timely manner.
4. Ensure the rider wears a helmet and other protective gear,
5. Minors need to use this product legally in accordance with local regulations
6. Minors must have parental approval and supervision to use this product.
7. Riders must not be under the influence of alcohol or drugs.
8. Do not operate the bike if the rider is unable to engage in strenuous activities due to illness.
9. Avoid riding in extreme weather conditions or when excessively fatigued.
10. While the bike is suitable for rain or snow, avoid water contact near the motor center to prevent damage to the internal circuitry.
11. Do not charge or park the bike indoors. Keep charging away from flammable materials, and avoid excessively long charging times.
12. Do not touch battery discharge components with hands, Avoid metal contact with battery electrodes and the bike circuit to prevent short circuits
13. Use the original charger for battery charging. Do not use the bike's battery for other devices to prevent damage.
14. Avoid using non-original parts, Unauthorized disassembly, cracking, or modification of the product and its components is prohibited. Any resulting damage or loss is your responsibility,
15. Regularly maintain brakes, tires, and other moving parts for proper bike functionality.
16. Services outside the warranty scope may require payment for maintenance and related services.

Thank you again for choosing and trusting our product.

1.Important warning	_____	1
2.Product components	_____	2
3.Technical parameters	_____	4
4.Product installation	_____	5
4.1 Install the handlebar	_____	6
4.2 Install the front wheel	_____	7
4.3 Install the front mudguard	_____	8
4.4 Install the front basket	_____	9
4.5 Install the front light	_____	10
4.6 Install the pedals	_____	11
5.Display instructions	_____	12
6.Battery	_____	17
7.Charging	_____	18
8.Warranty policy	_____	19

1.Important warning

This manual include important safety performance information and service information. Please make sure you have read the following warning content before the first time you use our product.

If you borrow your electric bicycle to other people, please let the user read this manual, it could help to decrease the risk of accident.

Please wear a suitable and safe helmet before riding, please wear the clothes with fluorescent and reflective stripes when you ride at night. Don't exceed speed limit, it is a main reason of traffic accident,

we should abide by the traffic rule, we shouldn't exceed the speed limit.

Don't touch the charging hole on the bike, or use metal touch it, otherwise, the accident will be caused by the transient short circuit of the current.

Zero starting, braking frequent, driving against the wind, carrying people or anything; insufficient air pressure on the tires. All of these will use much electric energy, and then reduce the endurance mileage.

If you want the best endurance mileage, please do something as follows :

- 1) Please use assist mode;
- 2) On the premise of safety, don't brake frequently or use zero starting.
- 3) Don't overload;
- 4) Before riding, please check the pressure of the tire and supply enough pressure.

Our Ebike should avoid prolonged exposure to the sun or rain, avoid storage in places with high temperature or corrosive gas, so as to avoid electroplating parts and paint surface by chemical

corrosion and electrical parts damage, resulting in operational failure and accidents.

Your current insurance business may not cover the situation you may encounter when riding an electric bike, please contact your insurance company or insurance broker for relevant consultation.

If you use our ebike in your country, pls refer to the local laws and regulation. For example in China, riding an electric bicycle must reach the age of 16. Bicycles are vehicles with certain risk factor, please be sure to abide by the traffic rules. At the same time, when emergency braking, brake the rear wheel first, then brake the frontwheel,

when cycling speed is too fast. There is a danger of tipping over if you brake the frontwheel suddenly, please ride carefully.

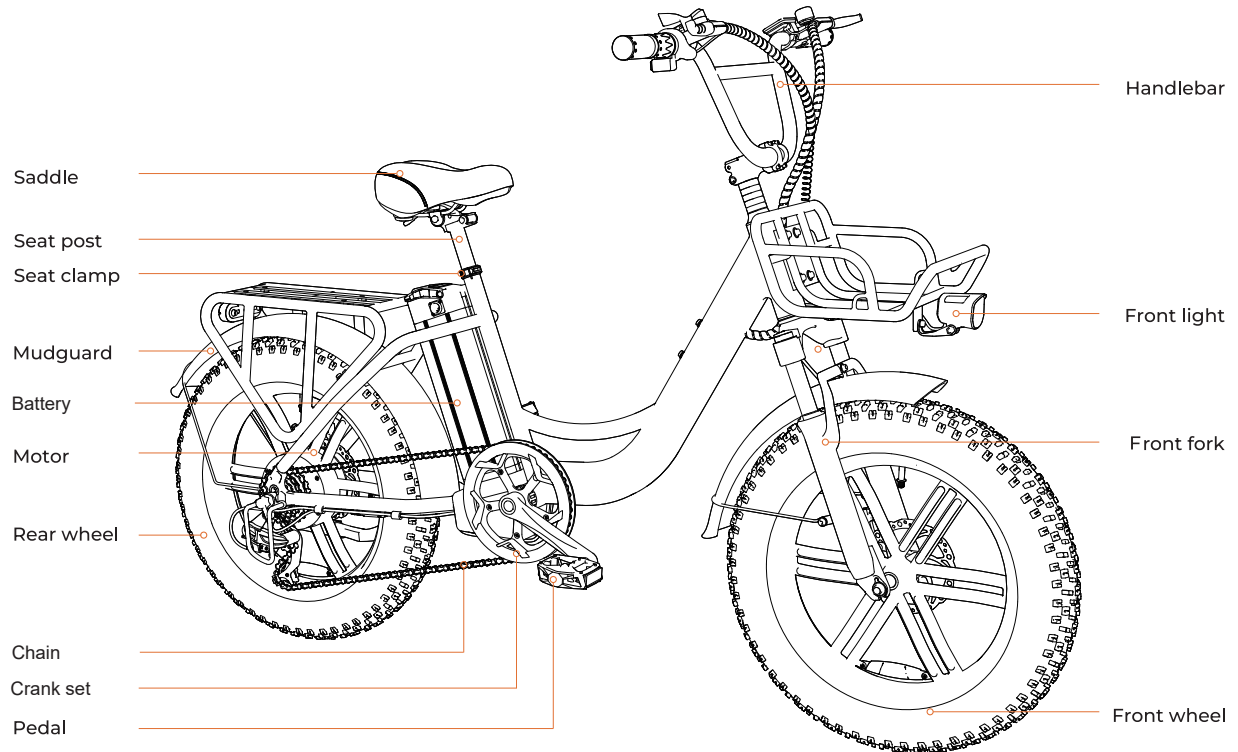

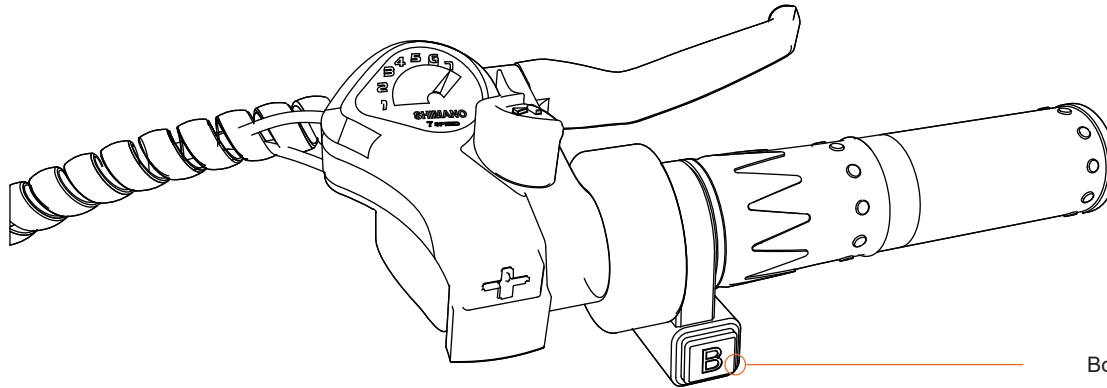

Boost button (B button)

Boost button (B button) operation instructions:

Press the B button while you riding with pedal assist to increase power. The power enhancement effect of a single operation lasts up to 60 seconds. If you need to increase power after 60 seconds, release the B button and press the above operation again.

Note:

1. For safety reasons, please use it when local traffic regulations allow.
2. The B button function does not work when riding with the throttle.

Performance index	Project	EU
Basic Parameters	Vehicle Size	1737*700*1140mm
	Wheel Size	20Inches
	Body Material	Aluminium alloy
	Maximum Load	120KG
	E-bike Weight	34KG
Main Parameters of the Whole E-bike	Maximum Speed	25km/h
	Maximum Gradient	10°
	Rear Derailleur	7-Speed
	Mileage Range	85km
	Working Temperature	-5°C~35°C
Battery Parameters	Rated Voltage	48V
	Battery Capacity	13AH
Motor Parameters	Motor Power	250W
	Motor Type	Brushless Gear Motor
Charger Parameters	Input Voltage	100-240v
	Output Voltage	54.6V
	Output Current	2A

4. Product Installation

- 1 Main frame
- 2 Saddle/Seat post
- 3 Front wheel
- 4 Tool box

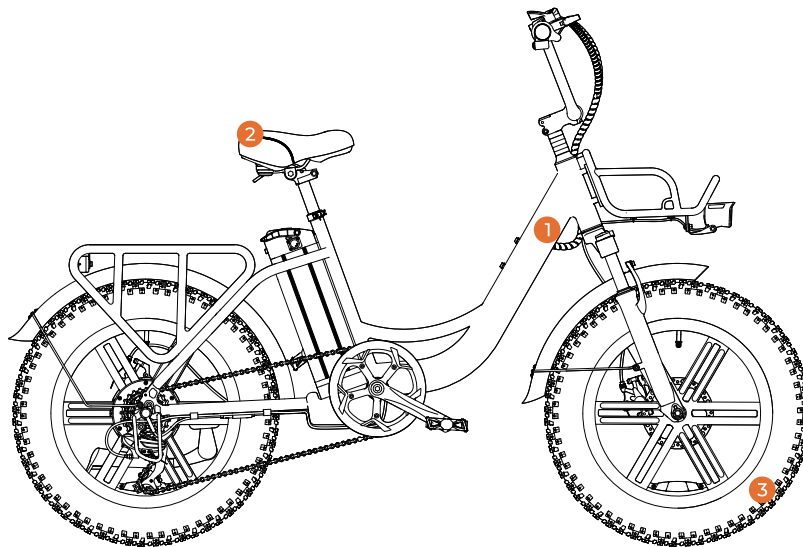

Tool box list

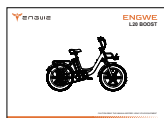

OWNER'S MANUAL



8-10mm/13-15mm/14-15mm
Wrench



Phillips screwdriver



4mm/5mm/6mm
Hex key

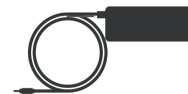

Charger



Bicycle Pedals

Please carefully inspect the items inside the box to ensure they are intact. If there are any missing or damaged items, please contact customer service promptly.

- (1) Remove the handlebars to remove the packing material and place the center at the riser clamlet.

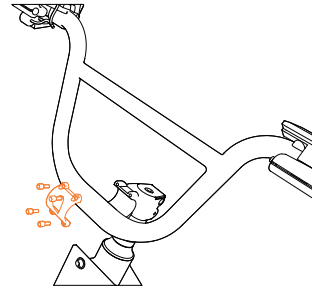
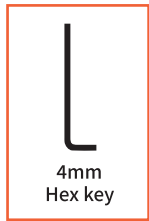

- (2) Install 4mm hexagon wrench clockwise. Do not tighten the 4 bolts in FIG.

A. Adjust the handle to the proper Angle in Fig. B, and then tighten the 4 bolts with proper force.

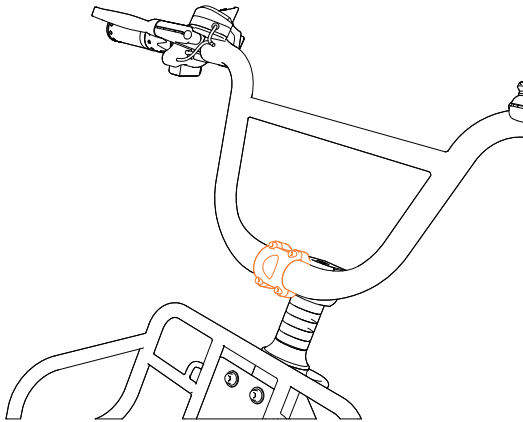

A

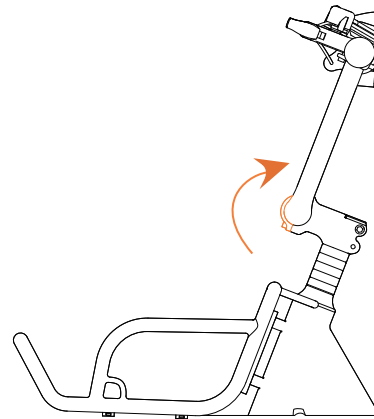

B

4.2 Install The Front Wheel

(1) Remove the front wheel to remove the packing material, and install the screw gasket shaft sleeve according to the drawing.

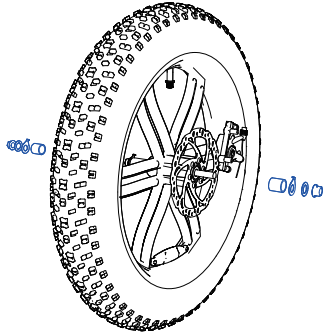

(2) Place the front wheel in the front fork card slot and lock it with a 15mm wrench.

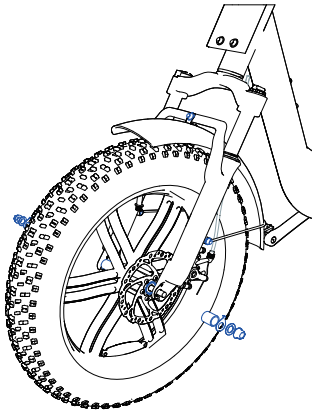

- (1) The lifting lug of the mud pan is connected with the hole of the front fork axle pipe, and then threaded in the screw to tighten it.
- (2) The mudguard support shall be aligned with the front fork mudguard take-up hole position, and then threaded into the screw for tightening.

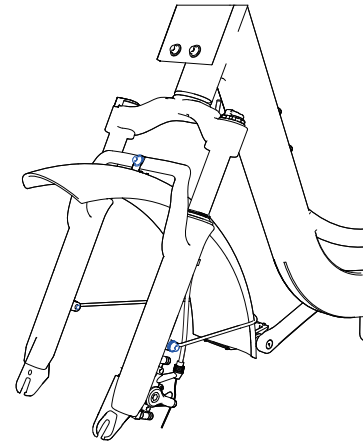
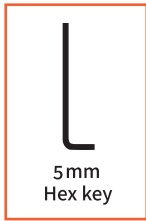

4.4 Install The Front Basket

- (1) Remove the basket to remove the packaging material, and install the screw gasket according to the drawing.

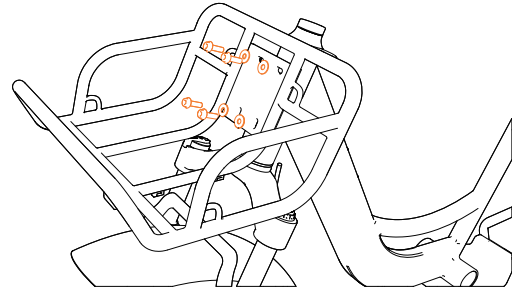
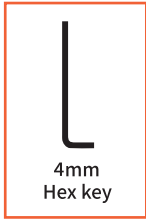

- (2) Install 4 bolts clockwise using a 4mm hexagon wrench, and place the harness in the front shelf hook.

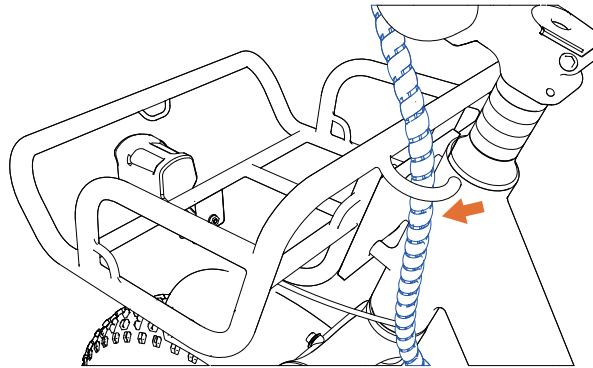
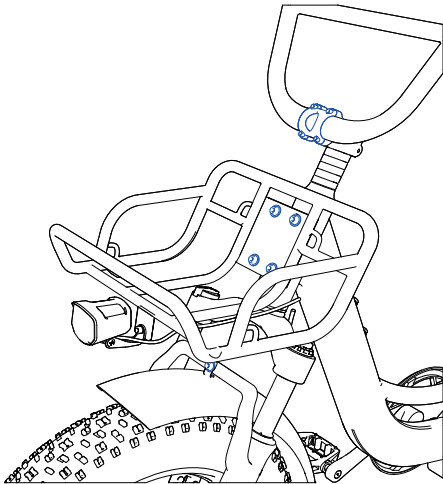

(1) Install the headlight screw washer nut according to the drawing.

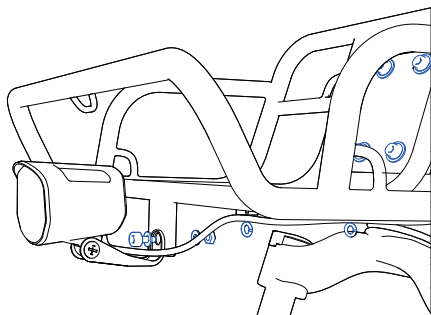

(2) The headlight line is fixed as shown in the figure.

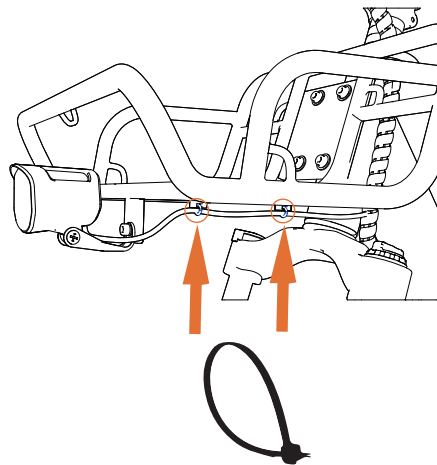
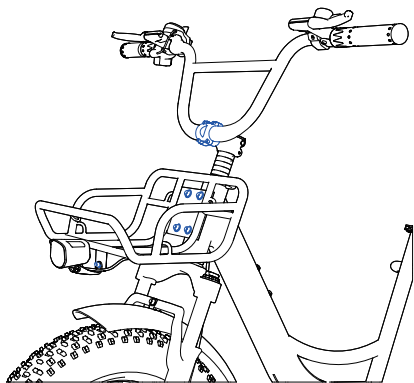

4.6 Install The Pedals

(1) Prepare left and right pedal, The pedal "R" is installed on one side of the chainring, and "L" is opposite to the chainring.

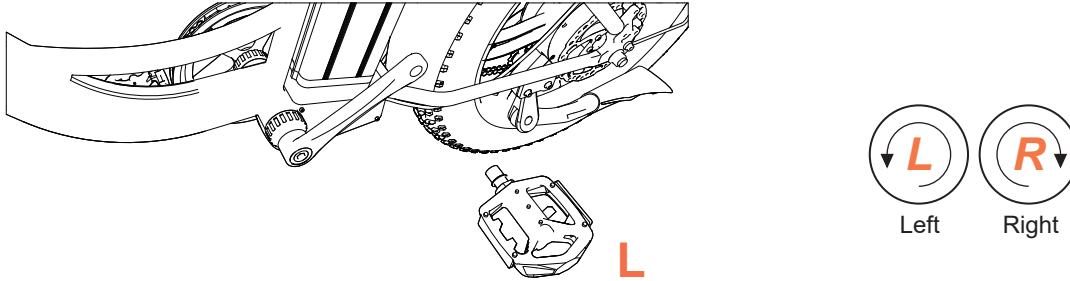

(2) Tighten the right pedal "R" clockwise, Tighten the left pedal "L" counterclockwise.

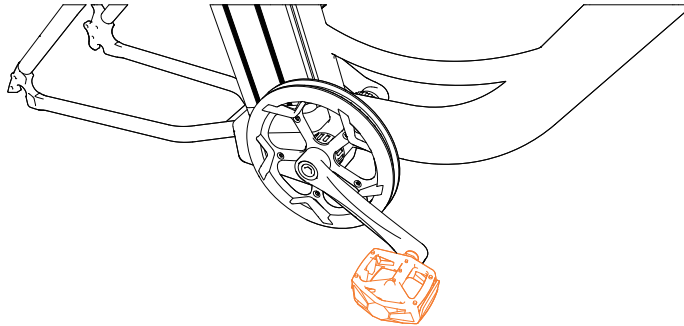

1.Product name and model name

Intelligent LCD display for e-bike; model: YL61F-D.

2.Specifications

- 48V power supply
- Rated working current 15mA
- Maximum working current 30mA
- Leakage current at power-off <1uA
- Working current at the supply controller end 50mA
- Working temperature -10~60℃
- Storage temperature -30~70℃

3.Appearance and dimension

4.Function overview and functional areas

4.1 Function overview

The YL61F-D display offers a variety of features to suit your riding needs, including:

- Battery level indicator
- Assist level adjustment and indication
- Headlight indicator
- Speed indicator (including real-time speed, maximum speed (MAXS) and

average speed (AVG))

- Distance indicator (including ODO and trip distance (Trip))
- Error code indicator
- Bluetooth connection indicator (reserved)
- Parameter setting function



4.2 Functional area layout

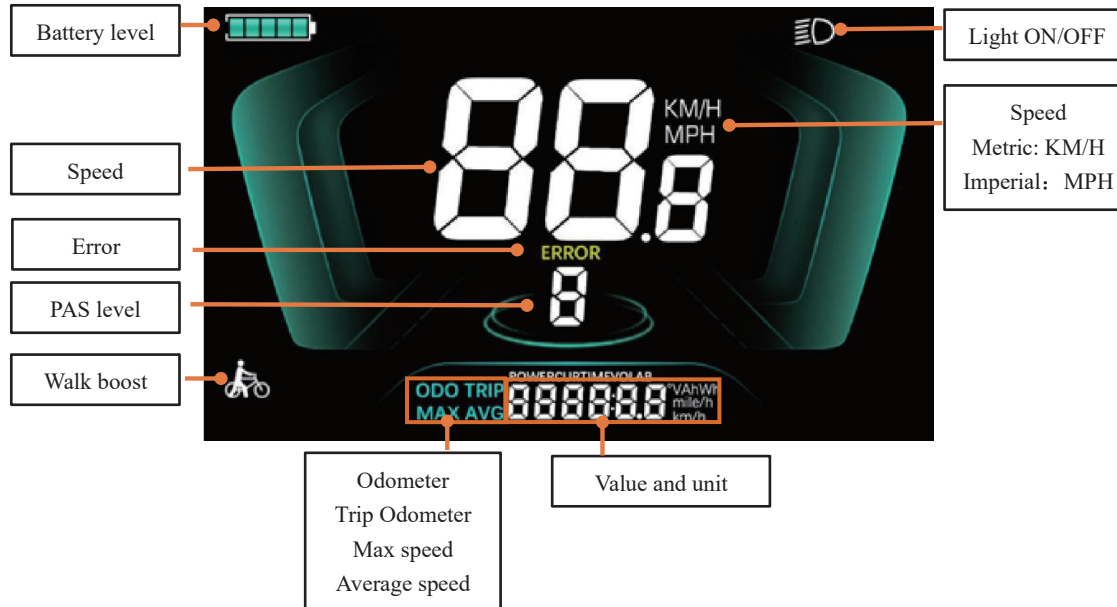



Figure 4-1 YL61F-D functional area distribution interface

4.3 Button definitions

The YL61F-D display is equipped with three buttons on the corresponding operating unit: power on/off , plus , minus .

5.1 Power on/off

Long press  to power on / off the display. When the display is off, it will not use the battery power and the leakage current is less than 1uA.



⚠ The display will automatically shut off if it is not used for more than 10 minutes.

5.2 Display interface switching

When the display is powered on, it will show the Current Speed (km/h) and Trip Odometer (km) by default.

Short press  to switched cyclically between Trip Odometer (km), Odometer (km), Maximum Speed (km/h), and Average Speed (km/h).

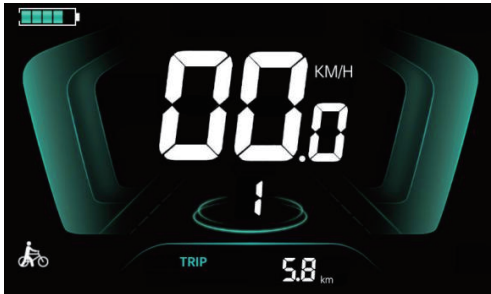

5.3 Walk boost mode

Long press and hold , the electric bicycle enters the walk boost mode. The electric bicycles will travel at walking speed and the display shows . Release the button to stop the power output immediately and restore to the state before walk boost.





⚠ The walk boost mode can only be used when pushing the electric bicycle, please do not use it while riding.

5.4 Turning on/off lights

Long press the  to make the controller turn on the lights and the display backlight becomes dim. Long press  again to make the controller turn off the lights and the backlight restore brightness.



5.5 Assist level selection

Press  /  to switch PAS level of electric bicycle, thus changing the motor output power.

5.6 Battery level display

The Battery level is shown as 5 bars. When the battery is full charged, all of the 5 bars lighten up. When the battery is fully depleted, the bar begin to flash, warning the user to charge the battery as soon as possible.



Full power 4 bars power 3 bars power 2 bars power 1 bar power



Empty power flashing

5.7 Error code indicator

If there is a fault occurs in the electronic system of the electric bicycle, the display will automatically show an error Code, see Schedule 1 for a detailed definition of the error code.



Schedule 1 Error Code Definitions

YL-02 Error codes			
Error code	Definition	Error code	Definition
E001	Controller failure	E004	Throttle failure
E002	Communication failure breakdown	E005	Brake failure
E003	Hall failure	E006	Motor phase failure

6. Battery

- How far a fully charged battery can go? That depends on the loading weight, road condition and battery capacity. But in the same condition, average speeds can continuous longer travel range.
- When storing the battery for a longer time, (during winter time) it is important to place the fully charged battery in a dry place.
- Attention: The battery should be re-charged once every 2-3 month when it is not used.

WARNING:

- Keep the battery out of reach for children.
- Never try to open the battery.
- Only use the ENGWE supplied battery. Do not use a battery from any other different product models.
- If the battery is damaged because it has been dropped somewhere or biking accident, there may be a risk of electrolytes leakage. Beware of chemical burns! And immediately stop using the damaged battery.
- Do not touch the battery without a cloth or gloves and make sure no acid touches your eyes.
- Do not store the battery in temperatures above 95°F or below 23°F.

- Do not allow the battery to run down completely before charging. Charge the battery before storing the product.

If the battery is completely empty, it may cause the battery to no longer charge.

- Charge a new battery for at least 4-6 hours before you use it in your product for the first time. Never charge the battery too long per time. Overheating or undercharging the battery may shorten battery life and decrease product run time.

IMPORTANT: BATTERY DISPOSAL

- Battery must be recycled or disposed of in an environmentally sound manner.
- Do not dispose of the battery in a fire. The battery may explode or leak.
- Do not dispose of a battery in your regular household trash.

- You can charge the bike directly, or you can remove the battery for charging.
- The RED light indicates it is in charging and GREEN light indicates the battery is fully charged. (Please put off plug from wall) Usually the charging time is 4-6 hours depends on the battery capacity remain.

WARNING:

- Charging time over 10 hours is prohibited, please kept it away from high temperature environment and stores it in a cool place.
- Please make sure that the battery charger and charging plug are always kept dry and never get wet.
- The charger should only be cleaned with a dry cloth. Never use a wet cloth, oil or any other liquid.
- Do not connect positive and negative terminals.
- Stop the charging procedure immediately if you notice anything unusual.
- It is strictly forbidden to cut the battery charging and discharging lines.
- It is strictly forbidden to disassemble the battery box or modify the internal structure and protection board of the lithium battery.
- It is strictly forbidden to disassemble the battery box or modify the internal structure and protection board of the lithium battery.
- After using the battery, please charge it within 12 hours.

If the product has problems with the following forms during the protection period, we will provide customer service as part of the product quality guarantee.

Dear customer !

Thank you for purchasing ENGWE series products !

Warranty service:

Please enter into the official website <https://engwe-bikes.com/> to view the warranty policy of Engwe.

After purchasing Engwe products, please kindly contact Engwe after-sales service for help when there is a quality issue, which means that you can contact customer service of the seller where you buy your e-bike from.

Please provide your order number, purchase interface, videos of the issue.



<https://engwe-bikes-eu.com>
<https://engwe-bikes.com>
<https://engwe-bikes.de/>

ENGWE INTELLIGENT TECHNOLOGY CO., LIMITED

Add: 4th floor, Building C, Jinhongde Industry Park, South Xuegang
Road, Bantian Street, Longgang District, Shenzhen, Guangdong, China
Zip code: 518129

PLEASE READ THIS MANUAL CAREFULLY BEFORE USING YOUR E-BIKE

