



# Manual

**BC281 Model(DTK5)**

Version: V1.0

## Contents

■ <b>Product Description and Specifications</b> .....	<b>3</b>
● Parts Description .....	3
■ <b>Function introduction</b> .....	<b>4</b>
● Features.....	4
● Buttons Functions .....	4
■ <b>Operation</b> .....	<b>5</b>
● Power on/off .....	5
● Riding interface.....	5
● Assist level switch .....	7
● Error Code .....	7
● User Menu.....	8
● Connect to APP (only for Bluetooth version) .....	12
■ <b>Attentions</b> .....	<b>13</b>

## ■ Product Description and Specifications



DTK5 Remote



BC281 Display

## ● Parts Description

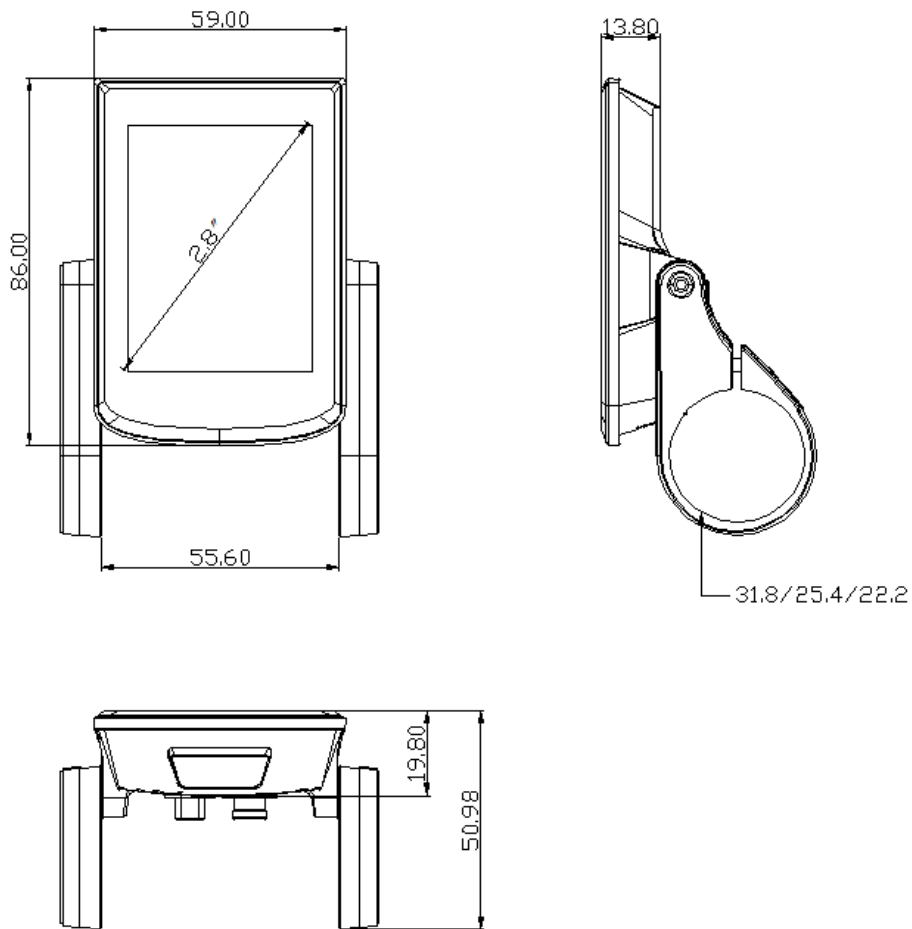

Display Dimensions

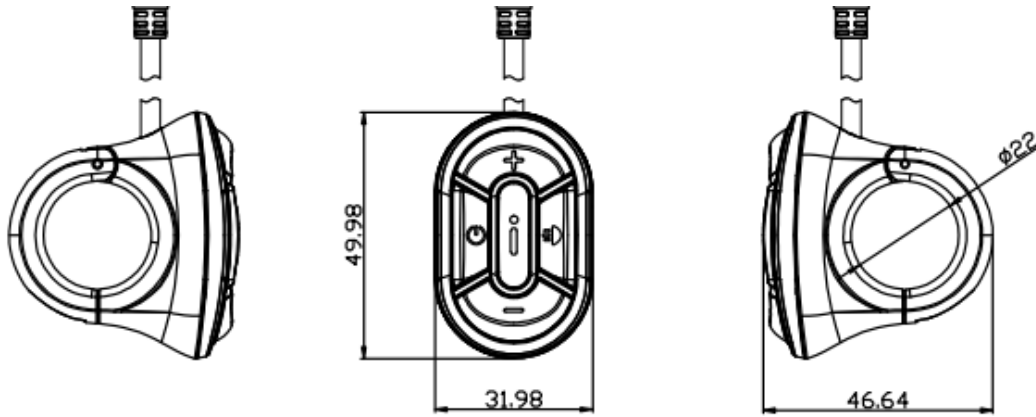

DTK5 Remote Dimensions

## ■ Function introduction

### ● Features





BC281 supports the common riding parameters and statistical results, as well as some useful functions:

- ◆ Real-time speed, Max speed, Average speed
- ◆ Real-time motor power
- ◆ Battery indicator
- ◆ Assistant level
- ◆ Odometer, trip
- ◆ Trip time
- ◆ Calorie burnt
- ◆ Light indicator
- ◆ Metric(km/h)/Imperial(mph) switching
- ◆ Error codes indicator
- ◆ Auto headlights, Brightness adjustment, automatic backlight
- ◆ Auto Power-off
- ◆ USB Port (5V/500mA)

In addition, the Bluetooth version also supports the following functions:

- ◆ APP connection
- ◆ Data synchronization
- ◆ Riding ranking
- ◆ Riding track recording

### ● Buttons Functions

Buttons	Name	Functions
	[  ]	1、 Power on/off 2、 Setting confirmation
	[  ]	1、 Parameter adjustment 2、 Menu operation

—	[—]	1、Parameter adjustment 2、Push mode on/off 3、Menu operation
i	[i]	
≡D	[≡D]	

## ■ Operation

### ● Power on/off

Long press the [⏻] button to power on, the boot interface will be shown for about 1.5s, followed by the riding interface:

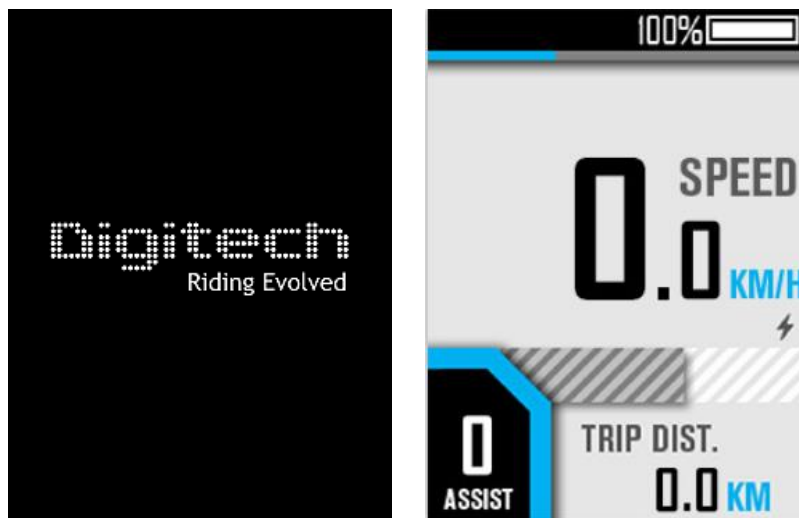

In any interface, long press the [⏻] button, the shutdown interface will be shown for about 2s before power off:

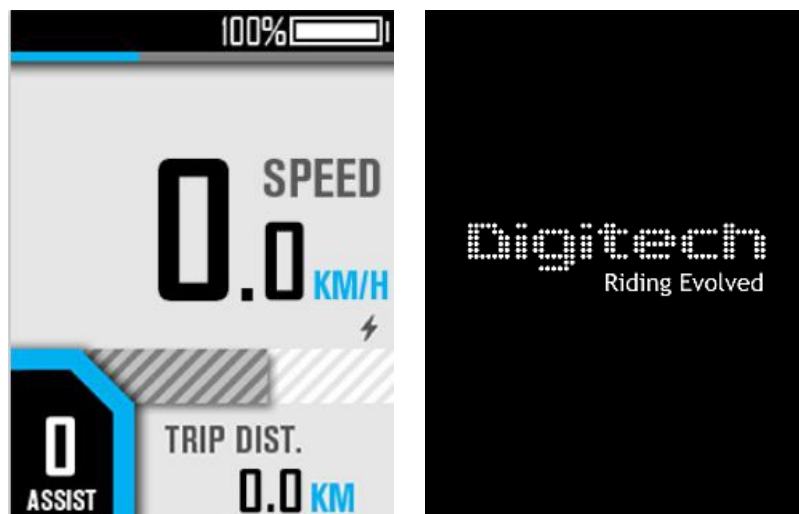

### ● Riding interface

BC281 provides various styles of riding interface, which can be switched by clicking the [ i ] button:

1. Simple mode

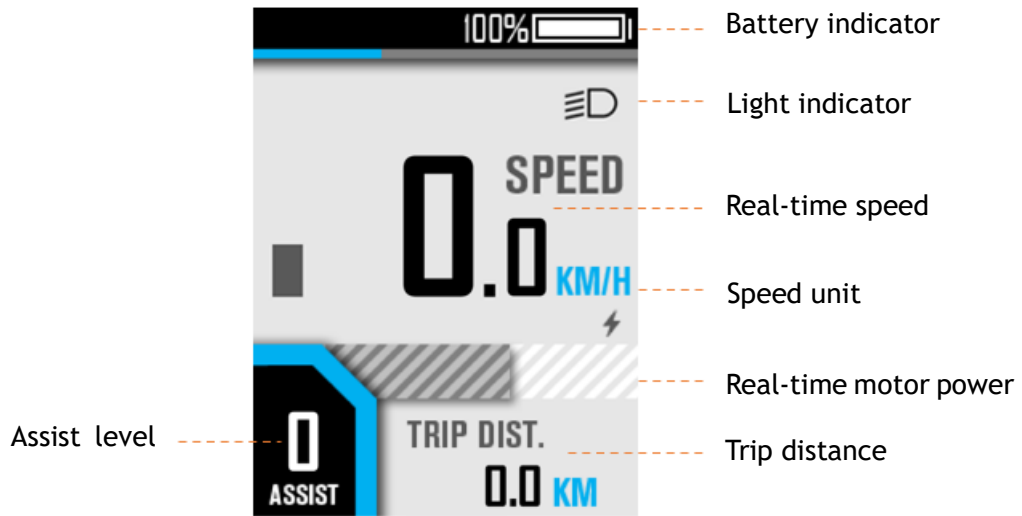

2. Sports Mode

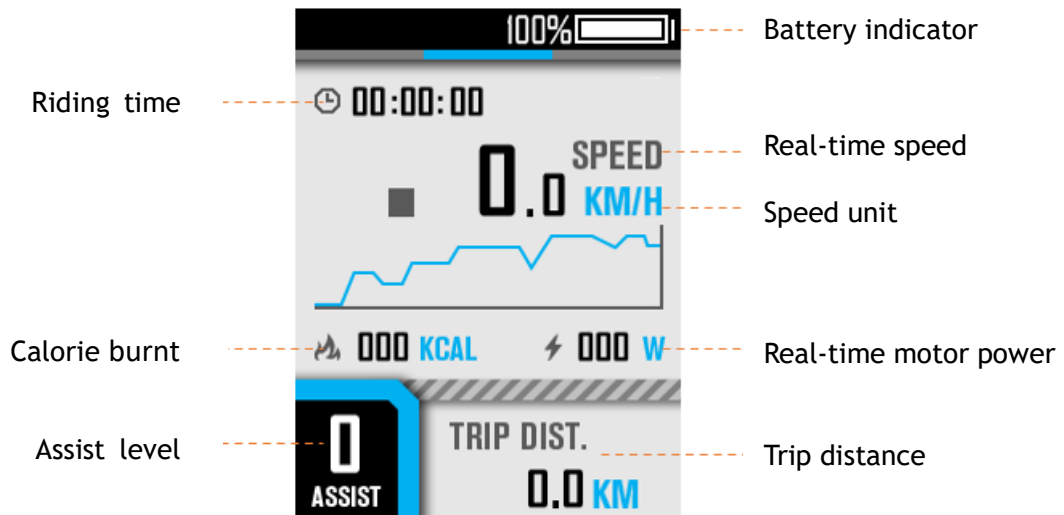

3. Statistical Mode

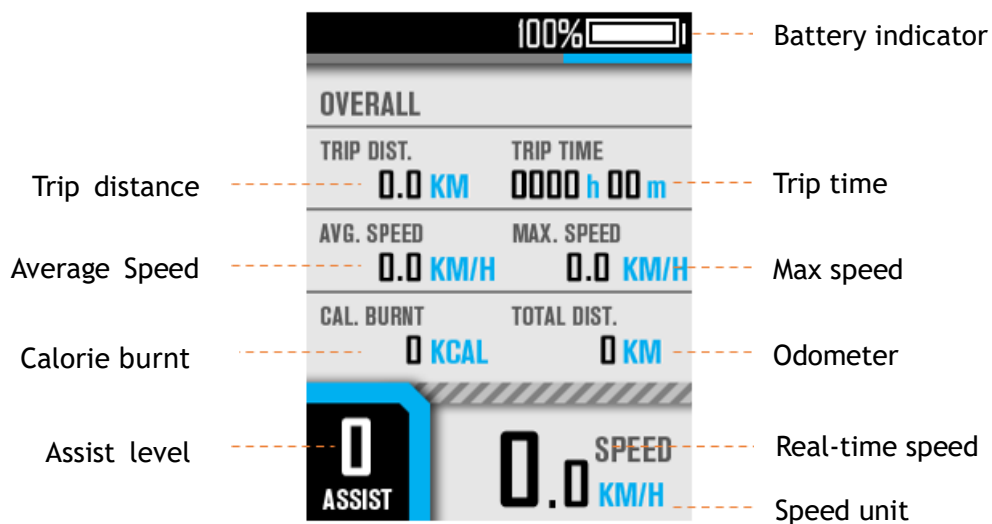

## ● Assist level switch

Click **[+]** or **[-]** to switch assist levels;

Press and hold the **[-]** button to enter the push mode, and release to exit.

## ● Error Code

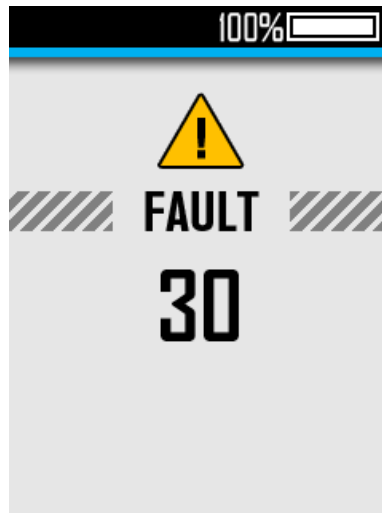

Common error codes are as follows(Only for reference, depending on other electrical parts of the ebike):

**KM5S protocol Error Code**

Error Code	Meaning
21	Current or Mos Error
22	Throttle Error
23	Motor Phase Error
24	Motor Hall Error
25	Brake Error
26	Low-voltage protection
30	Communication Error

**Li2 protocol Error Code**

Error Code	Meaning
02	Brake Error
06	Low-voltage protection
07	Motor Phase Error
08	Throttle Error
09	Current or Mos Error
14	Motor Hall Error
30	Communication Error

## ● User Menu

To enter the user menu, please long press the [ i ] button for 2s on the riding interface when static.

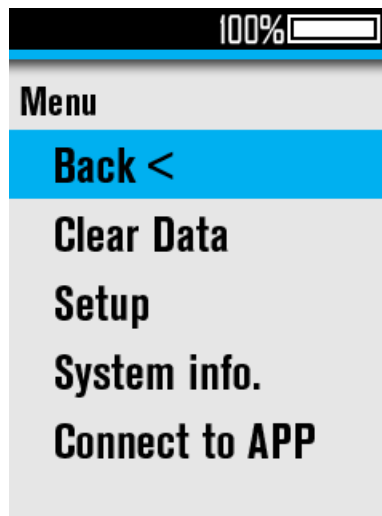

To ensure the user's safety, it can only be accessed when static (when the speed is 0). In this interface, you can switch the submenu by clicking the [ + ] or [ - ] button, and enter the submenu by clicking the [ i ] button

### 1、 Clear Data

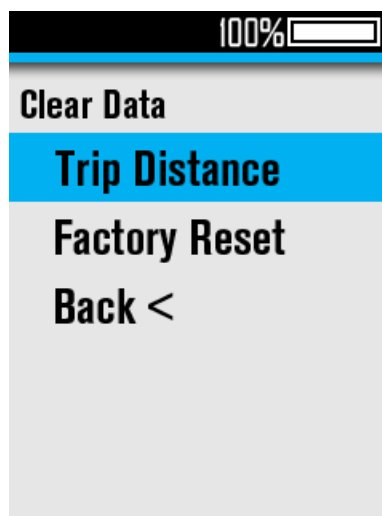

#### (1) Clear Trip Data

Select "Trip Distance" and click the [ i ] button to enter it, you can clear the trip distance or not under the guidance of the interface prompts:



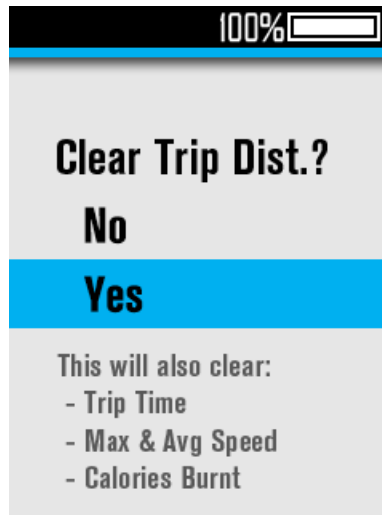

**[Note]** The trip time, max speed, average speed, and calories burnt will be also cleared by this operation.

(2) Factory Reset

Select "Factory Reset" and click the [ i ] button to enter it, you can reset the parameters:



## 2、 Setup

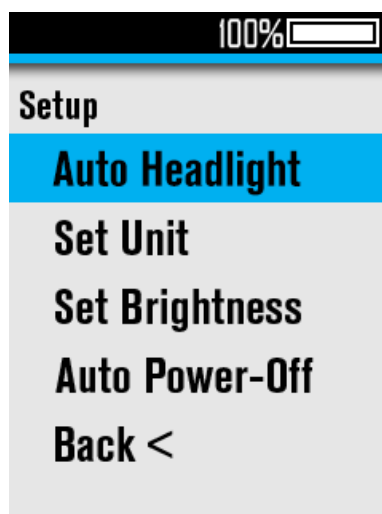

(1) Auto Headlight

Select Auto Headlight and click the [ i ] button to enter the submenu, you can enable or disable the automatic headlight function:

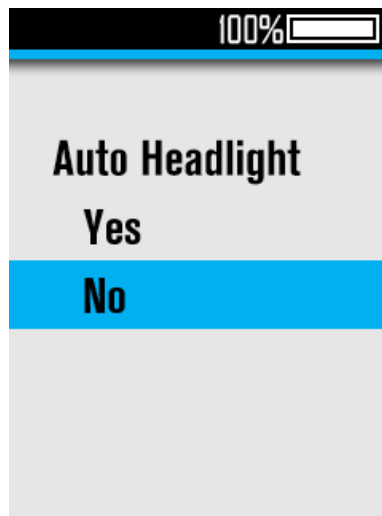

(2) Set Unit

Select Set Unit and click the [ i ] button to enter the submenu, you can select the unit:

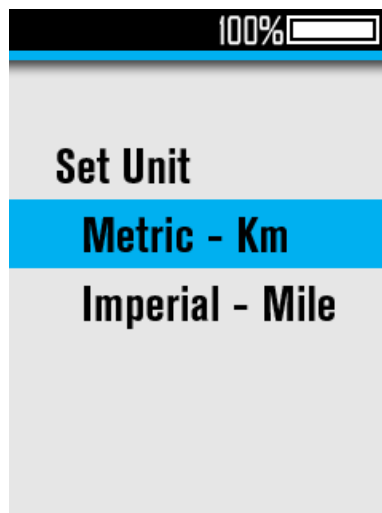

(3) Set Brightness

Select Set Brightness and click the [ i ] button to enter the submenu, you can use the [ + ] or [ - ] button to adjust the backlight brightness level in the range of 0-5:



(4) Set Auto Power-Off

Select Auto Power-Off and click the [ i ] button to enter the submenu. You can use the [ + ] or [ - ] button to adjust the automatically power off time in the range of 0-99, where 0 means not to automatically power off:

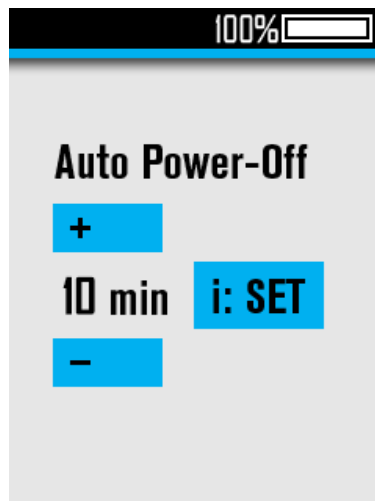

### 3. System Info.

Enter System Info, to view system information:

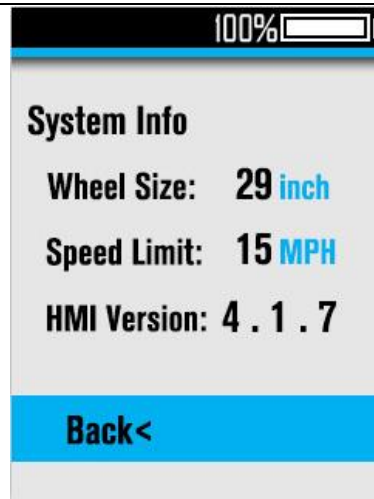

- **Connect to APP (only for Bluetooth version)**

1、 Scan the following QR code to download the APP:



2、 Select Connect to APP in the user menu to get the Bluetooth connection QR code, and scan it with the APP to connect:



## ■ Attentions

1. Be sure to power of first before connecting and disconnecting the cable, or the display will be totally damaged;
2. When fix the display to the ebike, please ensure that the torque of the screwdriver is about 0.2Nm (DO NOT EXCEED 0.6Nm), or it will cause damages to the handle;
3. Do not put the display into water;
4. The display can be wiped with wet and soft cloth, but DO NOT use any chemical liquid or spray on the display;
5. Please abide by local laws and regulations when scrapping, discard or recycle in an environmentally friendly way, and do not discard the instrument or any accessories as resident waste;
6. The damage and failure of the instrument caused by improper installation or use are not covered by the after-sale warranty.
7. For more information and support, please contact [support@riding-evolved.com](mailto:support@riding-evolved.com).