

Tennis Court Light

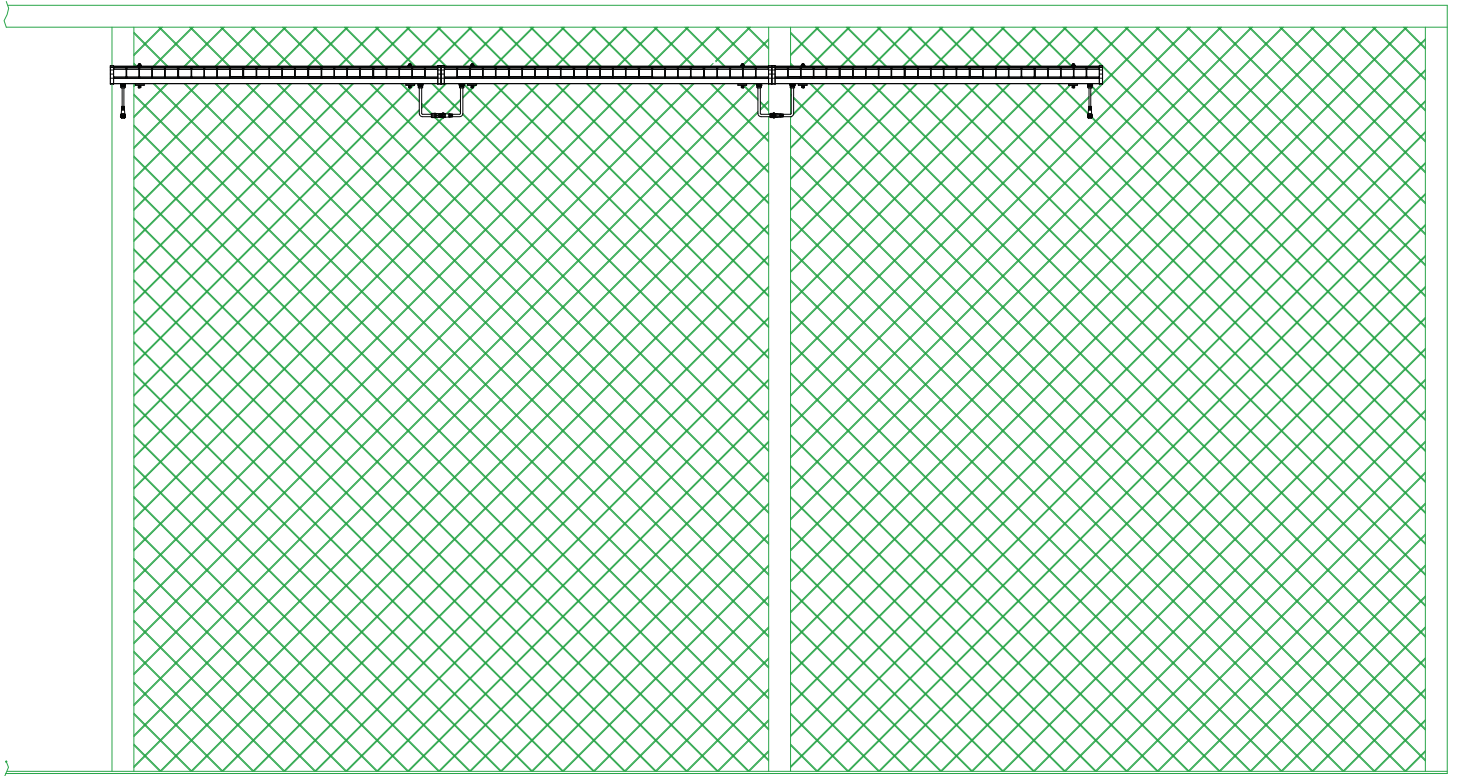

USER MANUAL / MANUAL DE USUARIO
MANUEL DE L'UTILISATEUR / BEDIENUNGSANLEITUNG
MANUALE UTENTE / MANUAL DE USUÁRIO

Tennis Court Light

WARNING

Connection block included. Installation of the luminaire may require the intervention of a qualified person.



PHOTOBIOLOGICAL RISK

The luminaire shall be so placed that a prolonged look at the luminaire don't expected at a distance closer to 2 meters

- The luminaire is designed for indoor and outdoor applications of tennis, paddel, badminton, etc.
- The luminaire settings are designed to operate at a . maximum set ambient temperature of $t_a 35^\circ$.
- The luminaire contains last technology protection screens for greater heat dissipation and greater work performance.

SPECIFICATIONS

Power Factor: >0.95

Waterproof: IP65

Impact Test: IK08

Voltage: 100-277V / 220-240V, 50/60Hz

N.W: 4.9kg

Dimensions(LxWxH): 1511*117*83mm

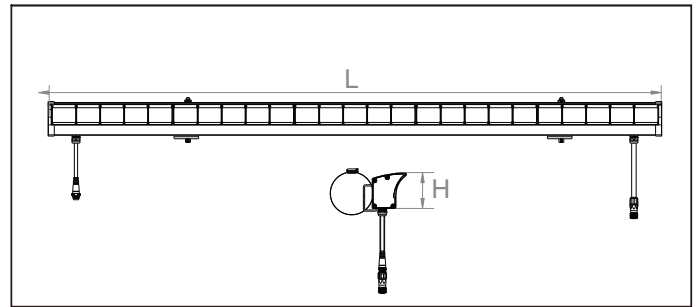

INSTALLATION

1.UNPACKAGING

Unpack the luminaire and check that no part hasn't beendamaged. If it finds any damage, keep the luminaire back inthe packaging and contact us.

2.HANDLING

If the luminaire is handled incorrectly after removal from thepackaging, damage may occur. Don't knock or stack luminaires after removing them from the packaging.

3.INSTALLATION

- Take out the lamp mounting seat in the accessory bag and fix it to the lamp body bracket with the fastening screws.

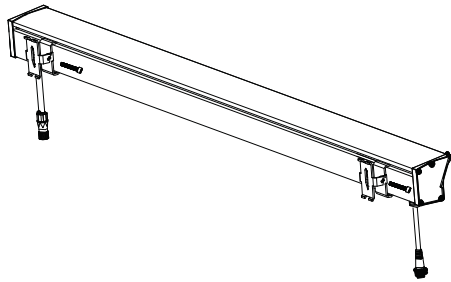

- Take out the metal hoop in the accessory bag, pass through the beam of the stadium fence, and cross the corresponding card position of the lamp mounting base, and tighten the fastening screws.

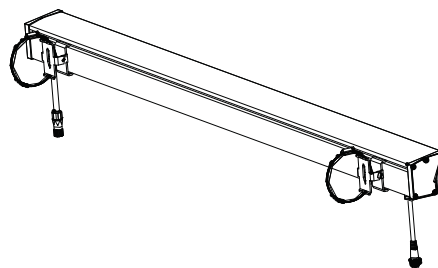

- Adjust the illumination angle of the lamp body as needed.

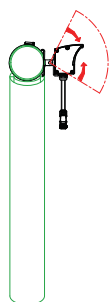

- Link power cords between light fixtures.

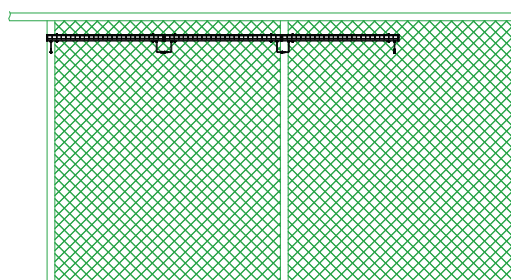

Solution

For Single Tennis Play Area

Solution: Class II, 300lx

2 lines of 20 pcs 43W

Power option: 1720W

Lux: 300lx

Uniformity:>0.7

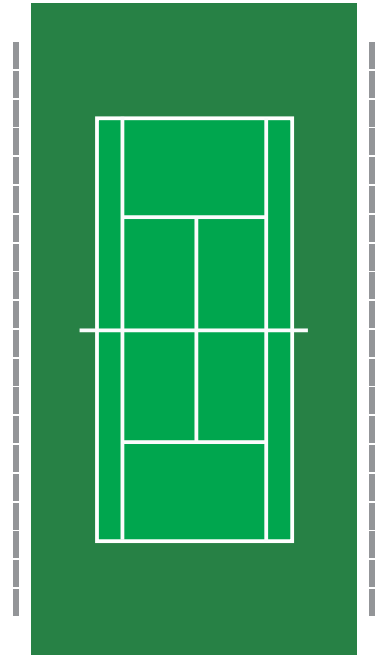

⚠ WARNING

Before carrying out any manipulation, make sure to disconnect the luminaire from the power supply. Any incidents in the installation haven't made in accordance with this installation guide will be the responsibility of the installer. Replacement or maintenance of any component must be supplied or recommended by the manufacturer. The light source of this luminaire should be replaced only by the manufacturer, its service or equivalent qualified person.