

# IP69K Triproof Light

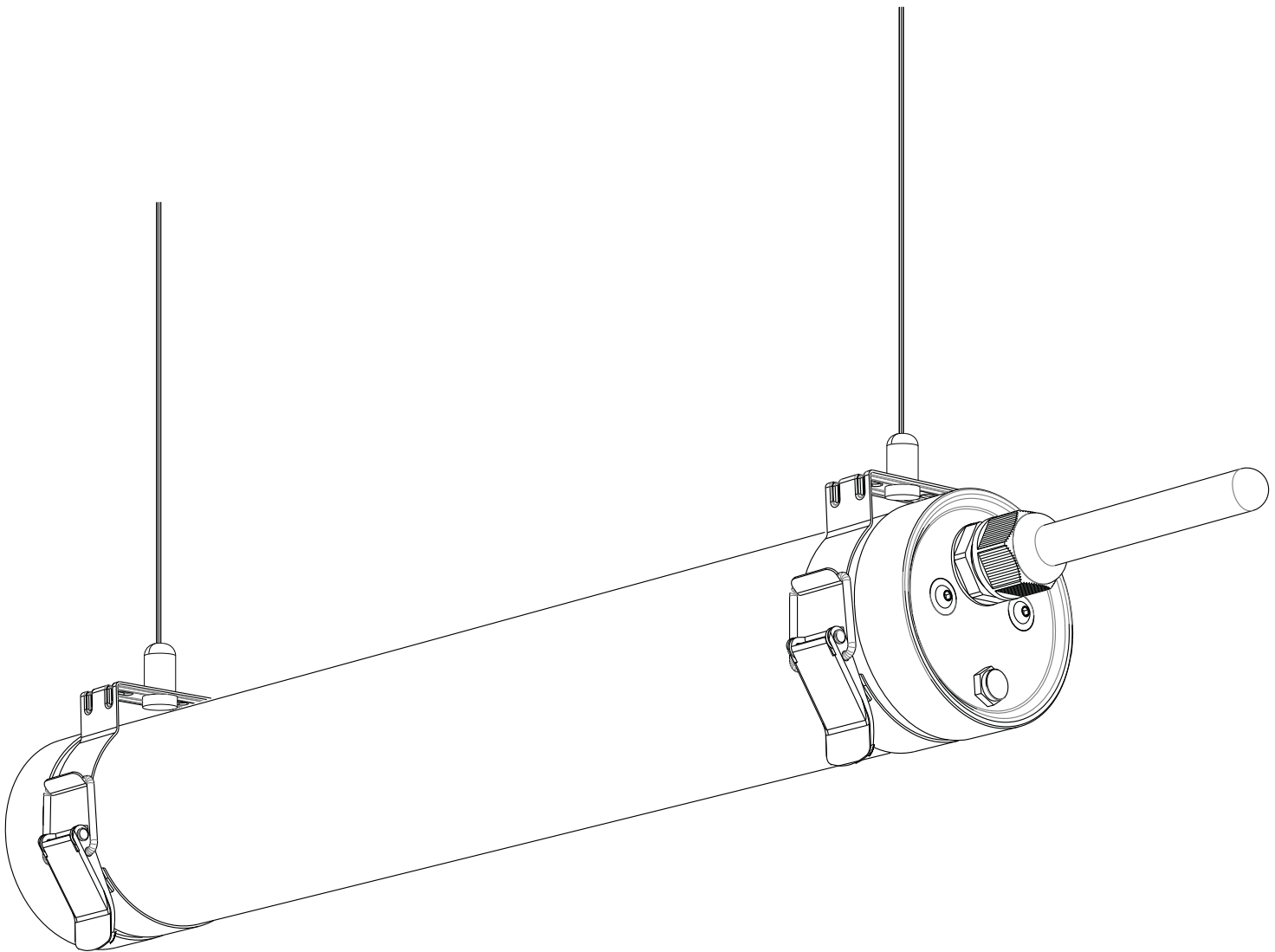

USER MANUAL / MANUAL DE USUARIO  
MANUEL DE L'UTILISATEUR / BEDIENUNGSANLEITUNG  
MANUALE UTENTE / MANUAL DE USUÁRIO

**IP69K** **CE**  **LVD EMC** 

## **WARNING**

Before carrying out any manipulation, make sure to disconnect the luminaire from the power supply. Any incidents in the installation haven't made in accordance with this installation guide will be the responsibility of the installer. Replacement or maintenance of any component must be supplied or recommended by the manufacturer. The light source of this luminaire should be replaced only by the manufacturer, its service or equivalent qualified person.

## **ADVERTENCIA**

Antes de proceder a cualquier manipulación, debe asegurarse de desconectar la luminaria de la alimentación eléctrica. Cualquier incidencia en la instalación que no se haya realizado de acuerdo con esta guía de instalación será responsabilidad del instalador. La fuente de luz de esta luminaria debe reemplazarse únicamente por el fabricante, su servicio técnico o persona cualificada equivalente. La reposición o mantenimiento de cualquier componente deberá ser suministrado o recomendado por el propio fabricante.

## **ATTENTION**

Avant de manipuler, assurez-vous de débrancher l'appareil de l'alimentation électrique. Toute manipulation sur l'installation qui n'a pas été réalisée selon ce guide d'installation est la responsabilité de l'installateur. Le remplacement de tous les composants doivent être fournis ou recommandés par le fabricant. La source lumineuse de ce luminaire ne doit être remplacée que par le fabricant, son service ou sa personne qualifiée équivalente.

## **WARNUNG**

Vor jeder Manipulation, stellen Sie sicher, dass die Leuchte von der Stromversorgung zu trennen. Alle Auswirkungen auf die Installation, die nicht wurde gemäß dieser Installationsanleitung durchgeführt ist die Verantwortung des Installateurs. Der Austausch oder die Wartung von Komponenten muß vom Hersteller geliefert oder empfohlen werden. Die Lichtquelle dieser Leuchte sollte nur durch den Hersteller, seinen Service oder eine gleichwertige qualifizierte Person ersetzt werden.

## **ATTENZIONE**

Prima di qualsiasi manipolazione, assicurarsi di scollegare l'apparecchio dalla rete elettrica. Ogni impatto sulla installazione che non è stata eseguita in base a questa guida di installazione è la responsabilità dell'installatore. Sostituzione o manutenzione di qualsiasi componente devono essere forniti o raccomandati dal fabbricante. La sorgente luminosa di questo apparecchio deve essere sostituita solo dal costruttore, dal suo servizio o da personale qualificato equivalente.

## **AVISO**

Antes de qualquer manipulação, certifique-se de desligar a luminária da fonte de alimentação. Qualquer impacto sobre a instalação que não foi realizada de acordo com este manual de instalação é de responsabilidade do instalador. Substituição ou manutenção de qualquer componente deve ser fornecido ou recomendado pelo fabricante. A fonte luminosa desta luminária deve ser substituída apenas pelo fabricante, pelo seu serviço ou por uma pessoa qualificada.

# IP69K Triproof Light

## SPECIFICATIONS

Electrical Power (W): 60W

Voltage (V) / Frequency (Hz): 220-240V · 50/60Hz

Power Factor: 0,95

CRI: >80

IP protection: IP69K

IK protection: 08

Electrical power class: Class 1

Beam angles: 120°

G.W / N.W:

· 60W: 2,30 Kg. / 2,61 Kg.

Dimensions (AxB):

· 60W: Ø81\* 1500mm

### ⚠ WARNING

Connection block included. Installation of the luminaire may require the intervention of a qualified person.



### PHOTOBIOLOGICAL RISK

The luminaire shall be so placed that a prolonged look at the luminaire don't expected at a distance closer to 2 meters.

- This luminaire is designed for industrial or commercial lighting applications where areas need uniform illumination over large distances such as warehouses, factories, car parks or shopping centers.
- The luminaire configurations are designed to operate at a maximum ambient temperature of  $t_a$  45°C.
- The luminaire is designed to be mounted horizontally with the LEDs facing downwards as shown in the image.

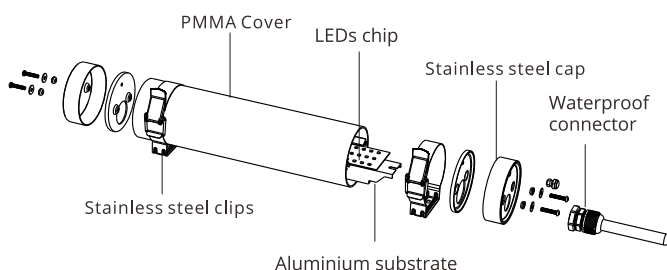
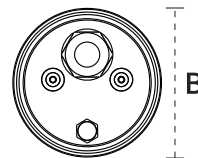
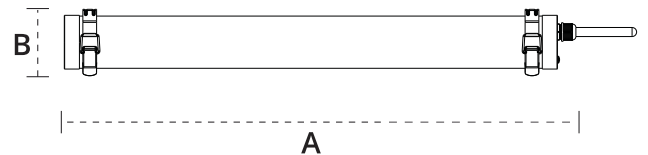

## INSTALLATION

### 1. UNPACKAGING

Unpack the luminaire and check that any part hasn't been damaged. If it finds any damage, keep the luminaire back in the packaging and contact us.

### 2. HANDLING

If the luminaire is handled incorrectly after removal from the packaging, damage may occur. Don't knock or stack luminaires after removing them from the packaging.

- The luminaire contains dust-proof aluminum screens, steam and impacts, resulting in increased protection and work performance.

### 3. WIRING

- Check that the supply voltage is correct and connect the power cables of the luminaire following the color code as shown in the indications.

**⚠ WARNING**  
The flexible cable or outside cord of this luminaire can't be replaced. If the cable is damage, the luminaire must be destroyed.

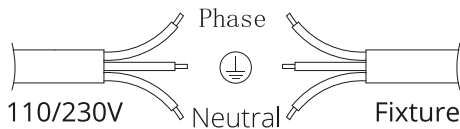
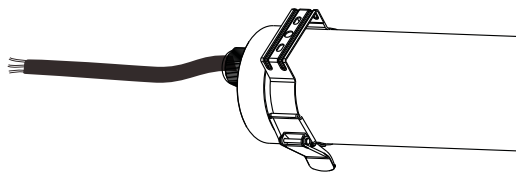

#### Connections

Cable colour:	Supply type:
Brown	Phase
Yellow / Green	Ground⊕
Blue	Neutral

- Once the cable connection has been made, check that is correct.
- If the connection is correct, proceed with the installation of the luminaire with the installation kit that best suits your needs.

### 4. MOUNTING

A) Recessed mounting:

**⚠ WARNING**  
For this type of installation you will need a surface installation kit.

- Make a hole in the ceiling to pass the connecting cables if necessary and make several holes for the placement of the hooks to the measurement of the luminaire.

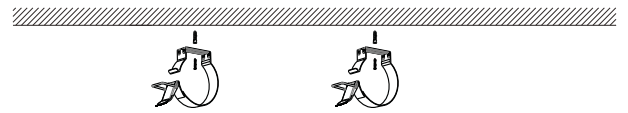

- Tighten the bolts on the hooks with a screwdriver until the roof hooks are securely attached.

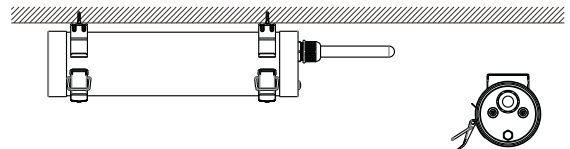

- If the installation is correct, the luminaire should be fixed as the image below.

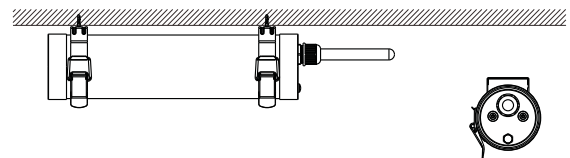

B) Suspended mounting:

**⚠ WARNING**  
For this type of installation you will need a suspension installation kit.

- Make the necessary holes in the ceiling and place the line block to place the fastening screws to the ceiling.

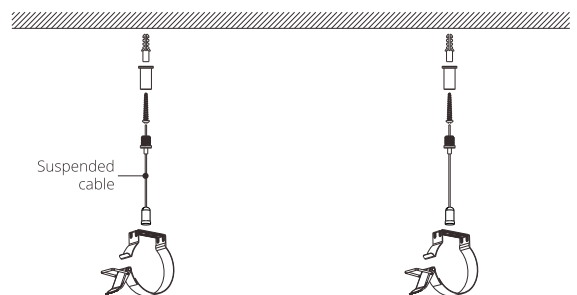

- Route the luminaire suspension cables through the holes and attach them to the roof hooks. If the installation is correct, the luminaire should be held as shown in the image below.

