



## User Manual

# Rustic - 3, 4

**Thank you for choosing our InfraNature Original Series!**

The Infrared sauna

Congratulations on the purchase of your brand new infrared sauna. Please carefully review and read through this material. Keep this manual and your proof of purchase for future reference and service calls.



# WELCOME FRIENDS!

We are so delighted that you have decided to take control of your life and invest in the most important thing – your health. Soon you will discover there is more to a sauna than just “sweating”. But first, allow us to introduce our company, what we do, why we do it and what you can expect from us.

We began our journey a decade ago with one goal in mind... To create an Optimal Health Product. We knew that general surface health treatments combined with inner cleansing could benefit many and provide many positive health results.

However, through the thorough cleansing methods we have tested, many of us have experienced headaches during a detox diet as well as lacking the ability to properly detoxify our system. There it hit us...What if we can increase our ability to sweat to detoxify the system faster and more efficiently without the unwelcome side effects? And how can we go about it?

Saunas have been in wide use for centuries, but the true breakthrough happened when the power of Infrared Light was introduced into the unique health industry, specializing in detoxification and cleansing. After much research and testing, we realized the benefits of infrared light are far more reaching than just on the surface, or slightly underneath the skin. This was truly an extraordinary discovery for us and we have devoted our primal business focus on exclusive manufacturing of infrared sauna that would maximize healing potential and maintain an optimal healthy physique. The understanding became a connection of dot – to- dot and we fell in love with our product so much, our team uses infrared saunas daily.

We wish to share this technology and to show our passion for what we sell and believe in. It is truly part of our personal journey, healing and inner belief that infrared saunas are safe and incredibly effective sources for personal detoxification and more.

Please let us know if there is anything you need. We are here to help.

Happy Detox!

Enlighten Sauna Team



# What You Need to Prepare Before Installing the Sauna

1. Choose the right Outdoor space and clear it out for the sauna.
2. When determining a location for your sauna, please keep in mind the following:
  - The main power cord on the sauna must be easily accessible.
    - When facing the sauna, the cord is located behind the back wall in the lower left hand side corner.
  - The location must be dry and leveled.
3. You will need a solid and leveled base. The sauna cannot sit straight on the ground.
4. Check the Electrical requirements for your specific unit and make sure you have it available. Please contact an electrician if you require assistance with this.
5. For a traditional heating system: Hardwire is recommended. Plug can be sent separately if preferred. For Infrared: it is a plug.
6. Prepare a Sealant to seal the sauna during the Installation of the sauna.
7. Tools: Phillips screwdriver, flat screwdriver, sealant gun. An Electric screwdriver will speed up the process.
8. Print or have your manual available during the installation.
9. Tech support for installation is available only at a pre-scheduled time. Submit a ticket online to schedule a time prior to **72 hours** of installation.
10. If you plan to have an electrician on site before the sauna arrives, schedule a phone call with our technician at least 72 hours in advance for a pre-installation process questions.



## Electrical Components/Requirements

Please Read Carefully!

### Infrared

Each sauna will require a dedicated circuit when plugged into an outlet according to the chart below. A “dedicated circuit” requires that no other appliance should share the outlet/circuit with the sauna. Failure to comply with this requirement may cause an electrical interruption and/or a diminished performance. To avoid any potential electrical hazards, it is recommended that only a qualified electrician installs your dedicated electrical wiring for a proper sauna functionality. Please make sure

that the sauna is properly grounded. Serious injury may result if the proper electrical requirements are not met.

**WARNING!** Keep the sauna away from any potential hazards, including any water source or liquids. Select a dry, suitable location for sauna installation. Do not expose the heater elements to any water source or liquids as it may cause electrical shock. Should you have any questions, please do not hesitate to contact the supplier.



## Power Plugs

Please read the following directions carefully.

### Rustic 3

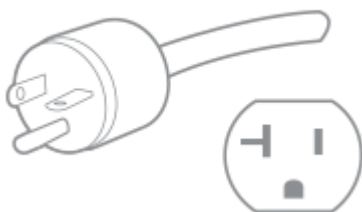

Power Usage/AMPS	
Wattage:	2650w
Voltage:	110/120 Volt
Near/Mid IR Wavelengths:	0 to 5
Far IR Wavelengths:	6 to 12
Amperage:	20 Amp minimum, 30 amp recommended*
Plug:	NEMA 5-20p

\*Minimum 20 Amp is required for the dedicated circuit, if you run a new line we recommend for you to have 30 Amp available.

### Rustic 4

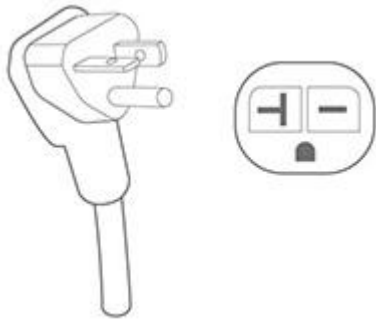

Power Usage/AMPS	
Wattage:	3750w
Voltage:	220/240 Volt
Near/Mid IR Wavelengths:	0 to 5
Far IR Wavelengths:	6 to 12
Amperage:	20 Amp minimum, 30 amp recommended*
Plug:	NEMA 6-20p

\*Minimum 20 Amp is required for the dedicated circuit, if you run a new line we recommend for you to have 30 Amp available.



## Choosing Sauna's Location

Your Enlighten outdoor sauna can stand outside without any cover or protection. The sauna requires a solid and level surface that will not flood. The saunas are very heavy so a solid foundation is highly recommended.

While Enlighten Outdoor saunas are specifically designed to be placed outdoors, choosing a location without excessive rain and wind is recommended.

Installation requirements for your sauna are as follows:

1. Your Enlighten sauna is a self-contained and freestanding unit. It should not be built into any structure without prior authorization.
2. Any modifications made to the sauna can waive the warranty, please get authorization before proceeding.
3. Please maintain a minimum of **4-inch clearance** on all sides of the unit to allow air to circulate while giving access for the power cord.



# Sealant Application

**VERY IMPORTANT:** Please follow these steps during installation as they are very important to ensure the sauna is properly installed.

1. Prepare before the installation and use similar sealant to prevent any leaks from happening:



2. Apply sealant on the sides (as shown on the images) as well as on the bottom and top of walls.





## Cleaning and Maintenance

1. Before using your sauna for the first time, clean the inside of the sauna with a clean damp cloth.
2. Make sure to always keep the sauna dry and clean.
3. Use a clean damp towel. DO NOT use a towel that is too wet and can drip water inside the sauna and DO NOT use cleaning agents inside the sauna.
4. DO NOT leave towels, water glasses or bottles inside the sauna after use. Wipe the exterior surface of the sauna with a towel and clean the glass at least once a month.
5. Place a towel on the bench to absorb any perspiration. Wash these often to maintain a clean and pleasant environment inside your sauna.
6. Perspiration may darken the wood over time. This can be removed by a light sanding with fine grit sandpaper.

### Wood Care

If the sauna exterior body has become scratched or scuffed, it could be concealed by using a small amount of furniture polish, oil or other furniture treatment. The interior blemishes, scratches, or scuffs can be either left alone, sanded or a combination of gluing plus sanding. Avoid any treatment containing benzene or a high concentration of alcohol.

Outdoor models' bodies need to be maintained on a regular basis (between 6 months to a year) by polishing or resealing the body as needed. If the varnish is cracked or worn off, sand the surface and re-varnish the affected area. Consult your local handyman or furniture repair professional for more details on how to maintain the wood in an outdoor environment. You can use any outdoor exterior clear wood sealer.



## Sauna Installation Instructions

Please read the following directions carefully.

The sauna installation requires a minimum of 2 people, 5 person model sizes require at least 3 people to install. You should not try to install the sauna on your own as damage may easily occur. Please read the instructions thoroughly before and during assembly to ensure proper installation of the unit. If

you encounter any problems or have questions during assembly, please feel free to call our Customer Support department at 1-888-877-2862.

## Caution!

1. Install the sauna on a completely leveled surface.
2. Keep all liquids away from the Infrared heating panels.
3. Flammable objects and corrosive chemical substances should be kept far away from the sauna.

Your Infrared sauna will come packaged in five boxes if you choose a SLOPE roof (seven boxes for PEAK roof saunas). Please make sure that you open the boxes FACE-UP. Please be very careful when opening the boxes!

BOXES CONTAIN FRAGILE PARTS AND GLASS!

Please be careful when carrying and installing the glass pieces to avoid breakage.



## Packaging

### CONTENTS OF BOXES

1. Floor Panel.
2. Ceiling Panel
3. Accessories
4. Left Side Wall
5. Right Side Wall
6. Front Wall
7. Back Wall
8. Bench and Bench Support
9. Outdoor Roof ( SLOPE OR PEAK)



## Location of Sauna & Installation Order



When determining a location for your sauna, please keep in mind the following:

1. The main power cord on the sauna must be easily accessible.
2. The location must be dry and level.
3. Panels should be installed in the following order:

1) Floor	4) Right Side Wall	7) Front Wall
2) Back Wall	5) Under Bench Support	8) Ceiling
3) Left Side Wall	6) Bench	9) Outdoor Roof

## Connecting the Panels:

Each sauna offers two types of panel-locking systems to connect the different sides of the sauna. Please use the instructions below as a reference guide on how to connect the sauna panels.

### Inner-Locking System:

The inner-locking system is designed to be completely invisible when the sauna is installed. The locks are built on the side of each panel and they connect by sliding one over the other (Figure G-2).

To connect two panels, follow these few steps:

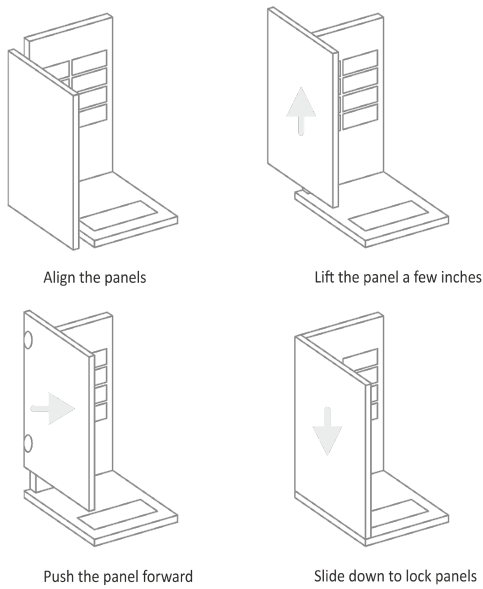

1. Lift the panel with the male locks a few inches.
2. Push it against the opposite panel; make sure to apply pressure around the top and bottom corners.
3. Slide the panel down to lock it in place. Make sure all the locks are connected (top and bottom).
4. Inspect the panels and make sure they are leveled (the panel's top is flat and matching).

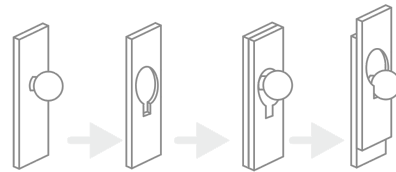

Figure G-2: Inner-Locking System

Figure G-1: Connect panels, inner lock system

### Latch System:

The Latch Locking System is two brackets that lock together bypassing the main loop over the opposite side and locking latch (Figure G-3).

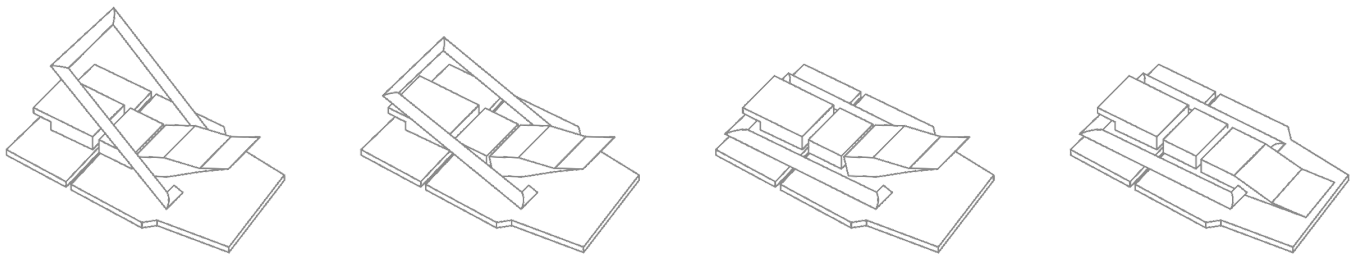

Figure G-3: Latch Locking System

## Where to Start:

Lay the boxes flat on the ground and open them carefully. The accessories, user manual, and smaller parts are located in the box that includes the top and bottom panels (Figure G-4).

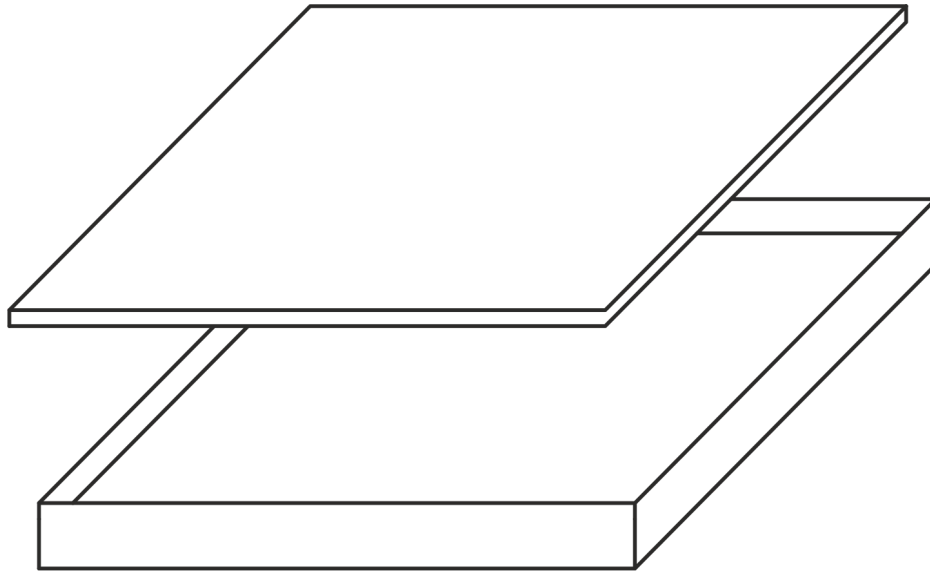

Figure G-4: Open the Box



## **ASSEMBLY INSTRUCTIONS – General Guide for:**

Begin with the FLOOR PANEL Placement:

Place the floor panel flat on the desired location. Make sure to leave a space around the sidewalls, where one person can stand and install the side panels (Figure A-1). Once completed, you can slide the sauna next to a wall.

Tips:

An “X” mark indicates the back of the sauna and the floor heater point to the front of the sauna.

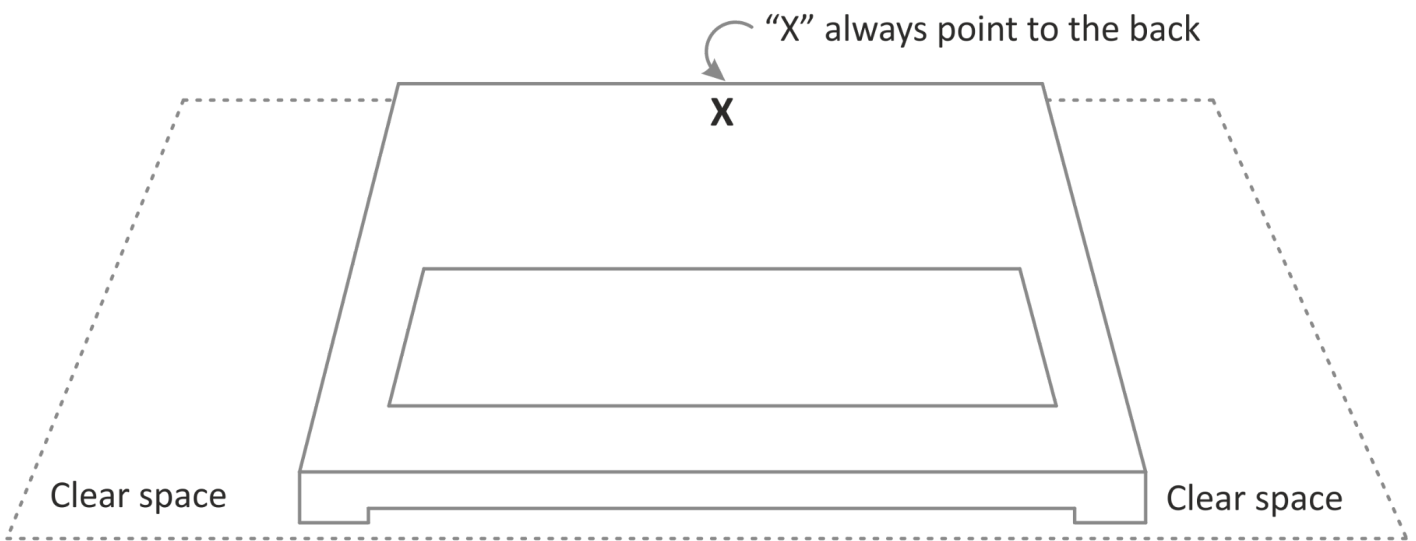

*Figure A-1: Floor Panel*

### **REAR PANEL Placement:**

Place the rear panel on the back end of the floor panel (Figure A-2). At this point, someone should hold the rear panel until the next connection is made.

### **LEFT PANEL Placement:**

Install the left panel (the left panel has 2-4 sockets on the lower end) as the image below. Make sure the top of both panels is flat and leveled.

Refer to “[Connecting the Panels](#)” section (page 10) on how to lock the panels together.

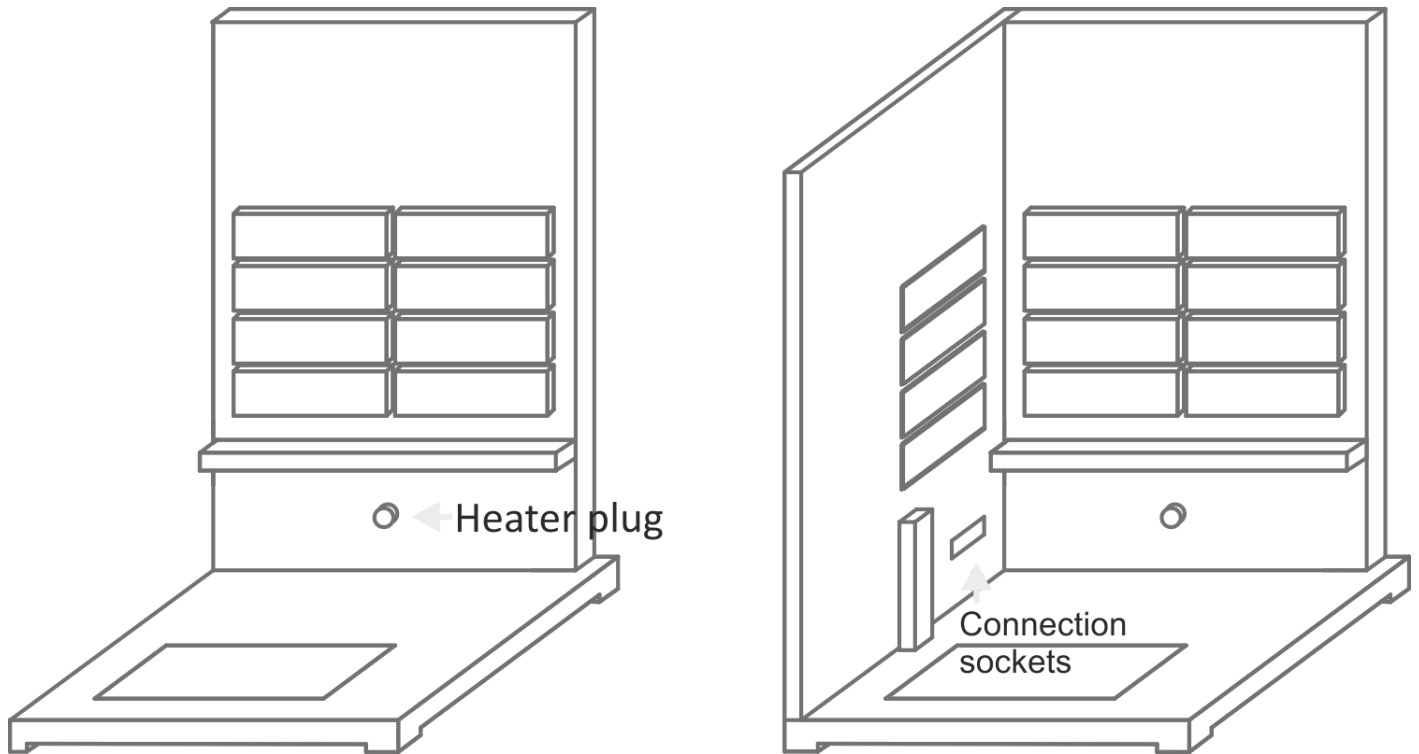

Figure A-2: Rear and left panels

## Installing the BENCH:

Slide the bench stand panel between the two vertical guides on the side panels. Connect the heaters' plugs under the bench to the appropriate sockets. The matching plugs and sockets are labeled alphabetically – e.g. connect “A” plug into the “A” socket.

Install the benchtop by placing it on top of the bench stand and the horizontal guide on the rear panel. Make sure the smooth and finished side is facing up and forward (Figure A-3).

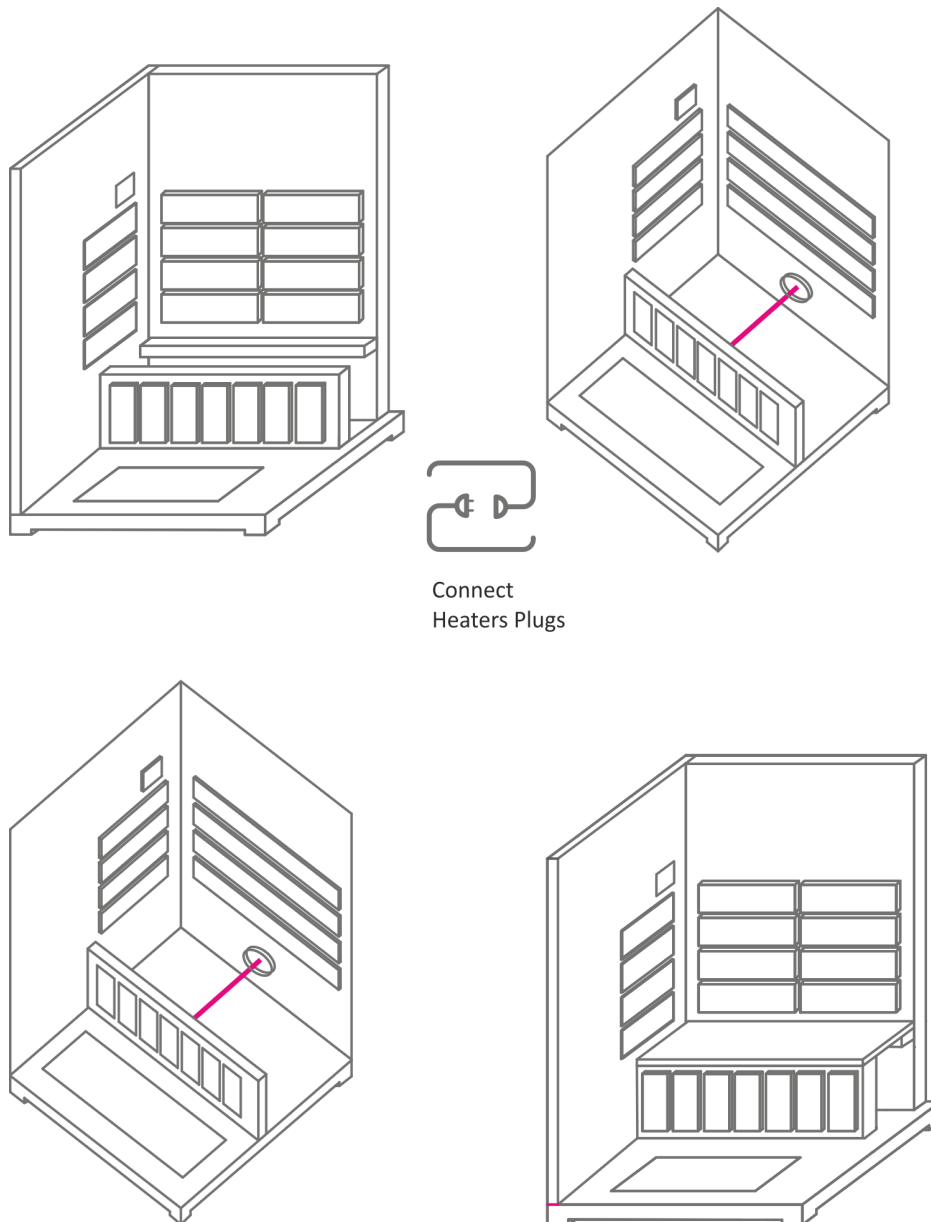

Figure A-3: Installing the Bench

## RIGHT PANEL Placement:

Install the right panel as the image below (Figure A-4). Make sure the top of all the panels is flat and leveled. Refer to “[Connecting the Panels](#)” section (page 10) on how to lock the panels together.

### Tip:

- Someone can stand inside the sauna to match the bench stand with the vertical guide on the right panel and level the corners for easy installation. If the lower lock is not connecting, make sure the bench stand is not blocking the panel by aligning it with the vertical guide.

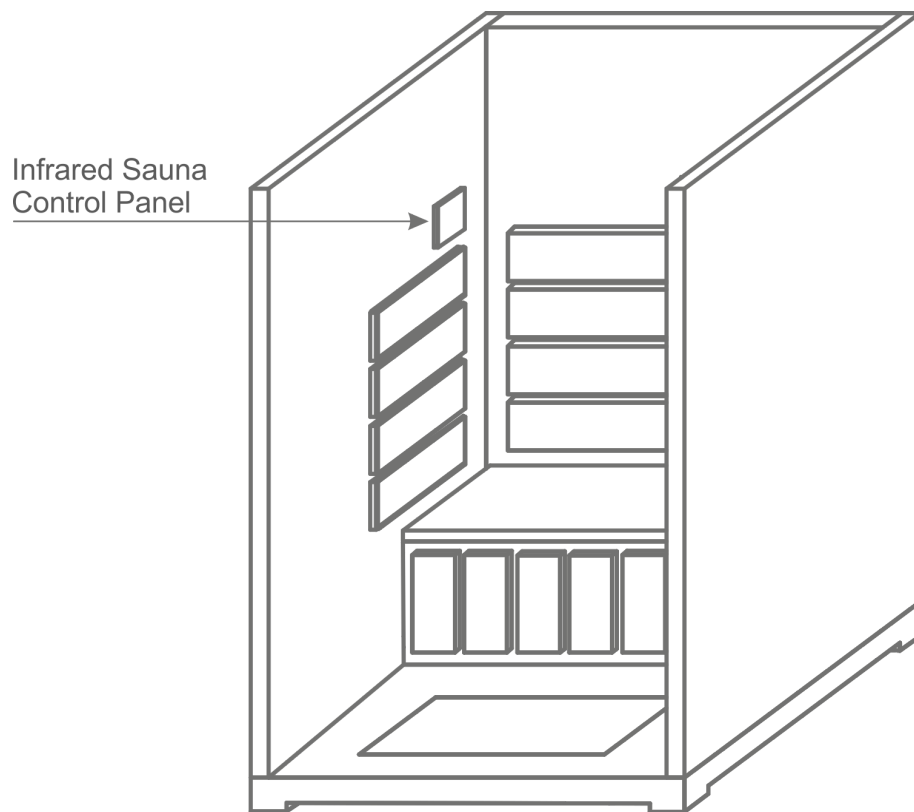

Figure A-4: Right Panel

### IMPORTANT:

Install the DOOR HANDLE at this point (before installing the FRONT PANEL).

## FRONT PANEL Placement:

Connect the front panel to both side panels as in the following image on the next page (Figure A-5). Refer to “[Connecting the Panels](#)” section (page 10) on how to lock the panels together.

### Tips:

- Make sure to align the corners of the two side panels and the edges of the front panel.
- The front panel is heavy because of the glass door. At least two people are needed to lift it.
- For the inner locking system, a person can stand inside the sauna to align the edges and corners of the panels.
- For the inner locking system, make sure to put pressure on the top and bottom corners of each side to ensure the locks are connecting.

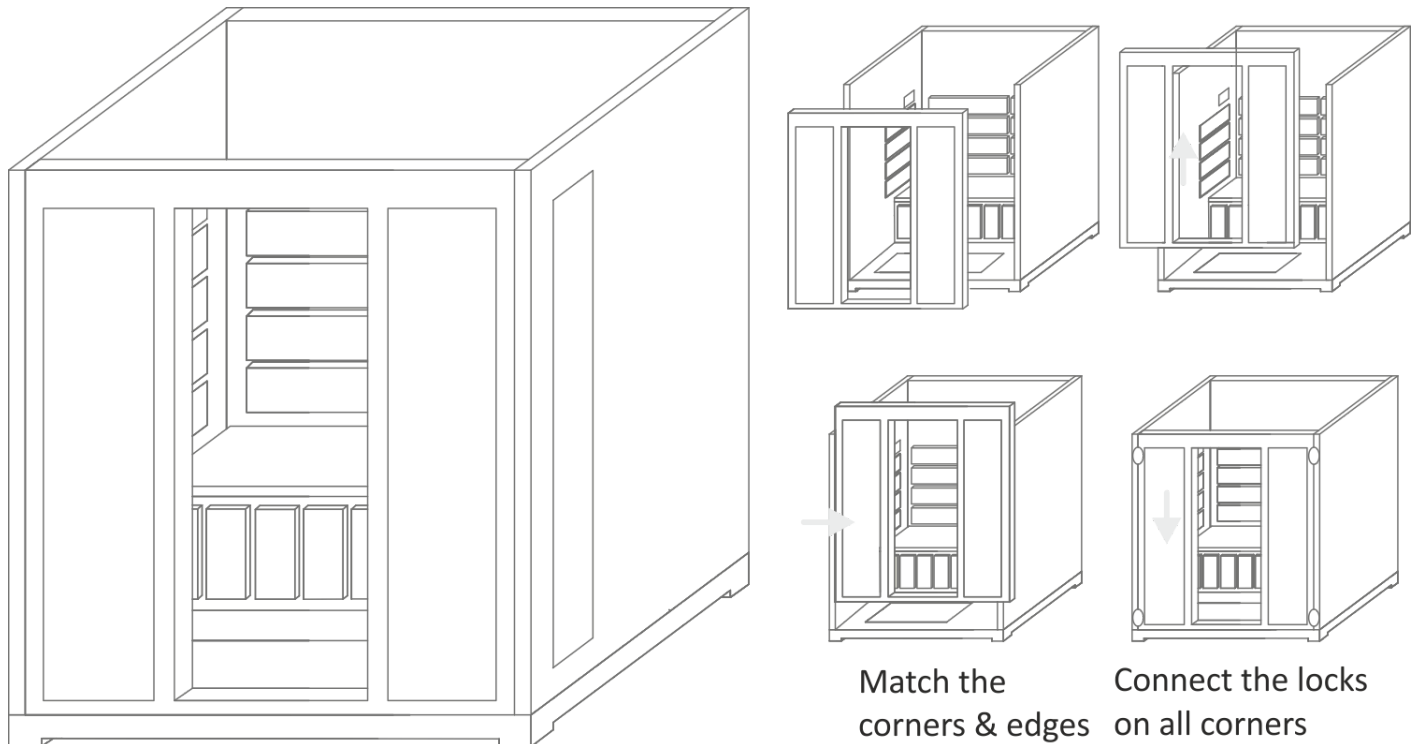

Figure A-5: Front Panel



## TOP PANEL Placement:

**Step 1.** Raise the top panel over the sauna body. Insert the wires for the control panel, temperature sensor, and heaters through the openings in the ceiling.

**Step 2.** Connect the control panel wire (white ribbon) and the heat sensor (2-pin wire) on top of the sauna.

**Step 3.** Connect the heaters' plugs into the control box. Even though the heaters' plugs might be labeled, they can connect into any sockets on the control box.

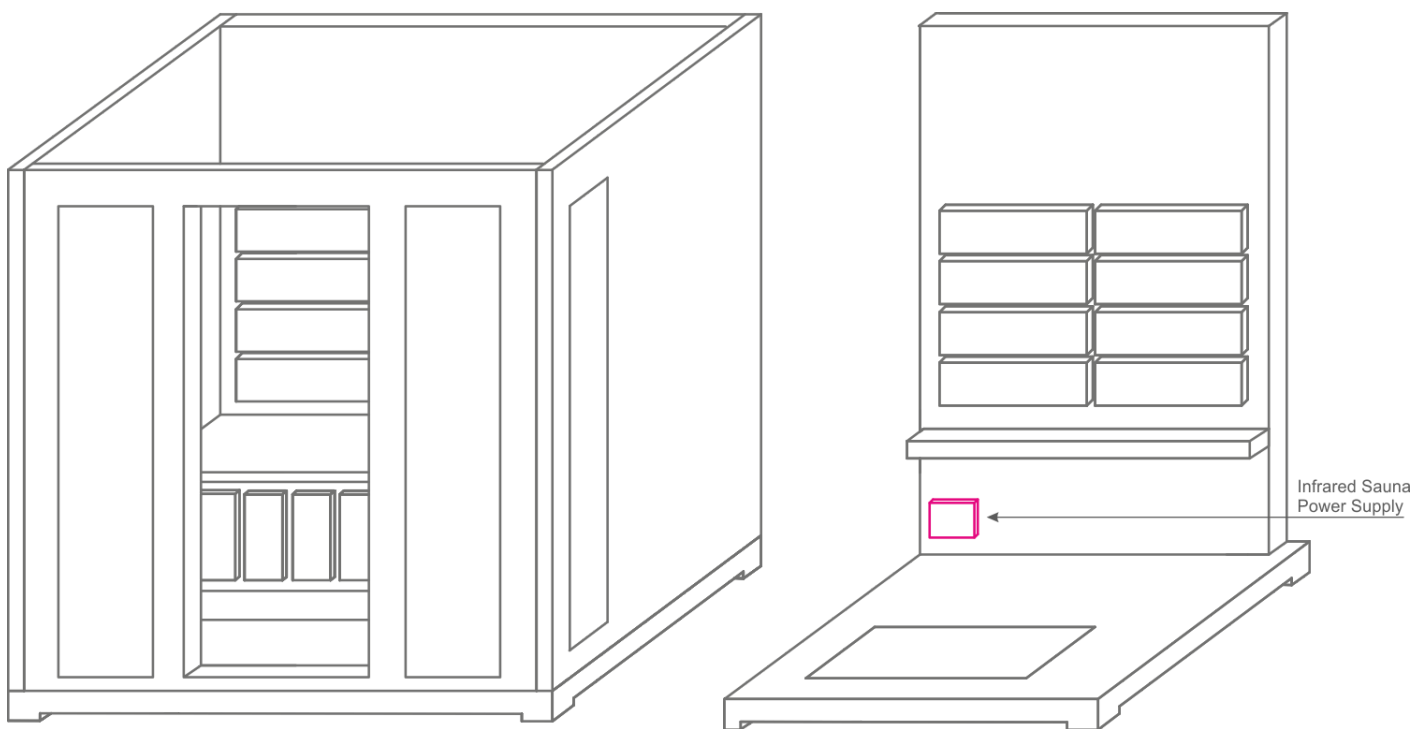

Figure A-6: Top Panels and Connections

**Note:** Accessories installation instructions continue below the outdoor models.

If you bought an Indoor Version, the Top Panel is your Indoor Roof. Skip OUTDOOR ROOF ASSEMBLY INSTRUCTIONS.

If you bought an Outdoor Version, please proceed with the OUTDOOR ROOF ASSEMBLY INSTRUCTIONS.

## OUTDOOR SAUNAS ASSEMBLY INSTRUCTIONS:

Installation steps start at the section [“Assembly Instructions – General Guide”](#). Then continue after placing the top panel.

### Main Support

Place the roof bottom section on top of the sauna and screw the center support beam (Figure D-1). The illustration below will not include the sauna’s body, but the roof should be installed on top of the sauna.

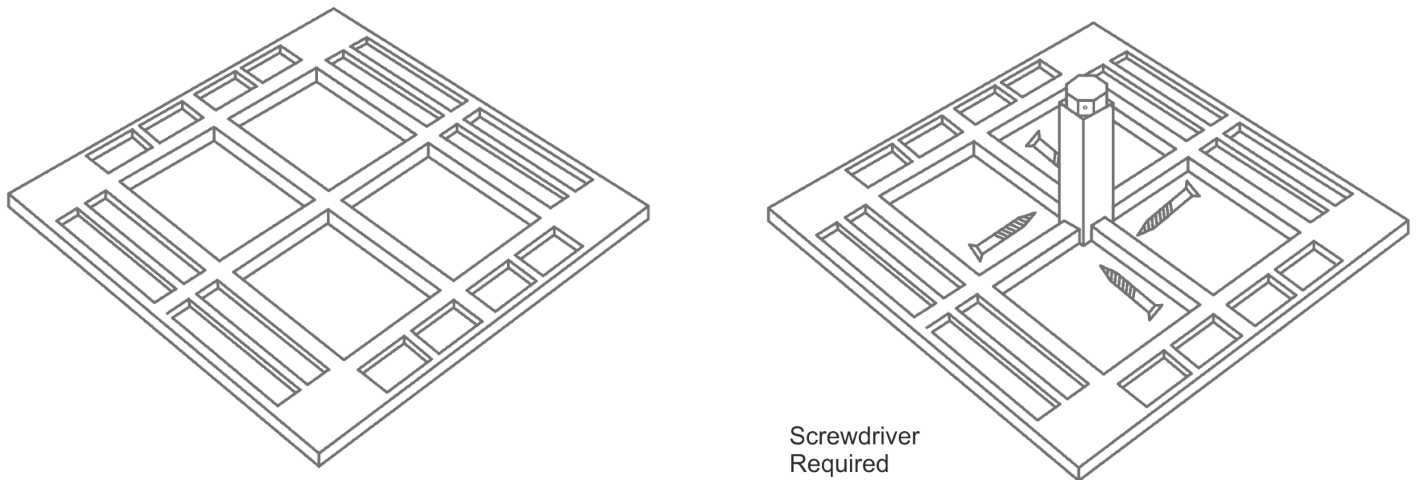

Figure D-1: Roof bottom section and center support beam

## Roofing Shingles Support

Install the roofing shingles support beams around the top. Each beam is labeled alphabetically to a matching corner or side (Figure D-2, Page 25). For example, the beam marked with “A” should be screwed into the “A” corner. Repeat for all the corners and sides (based on the model, you might have eight or six supporting beams).

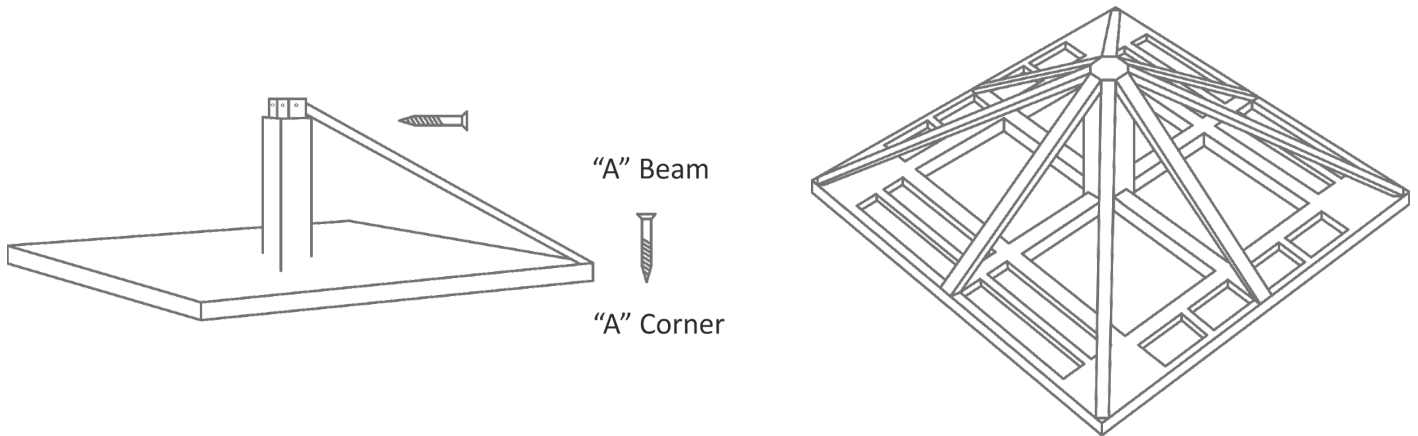

Figure D-2: Shingles Support Beams

Screw the triangular roofing shingles on the supporting beams (Figure D-3). Repeat for all sides.

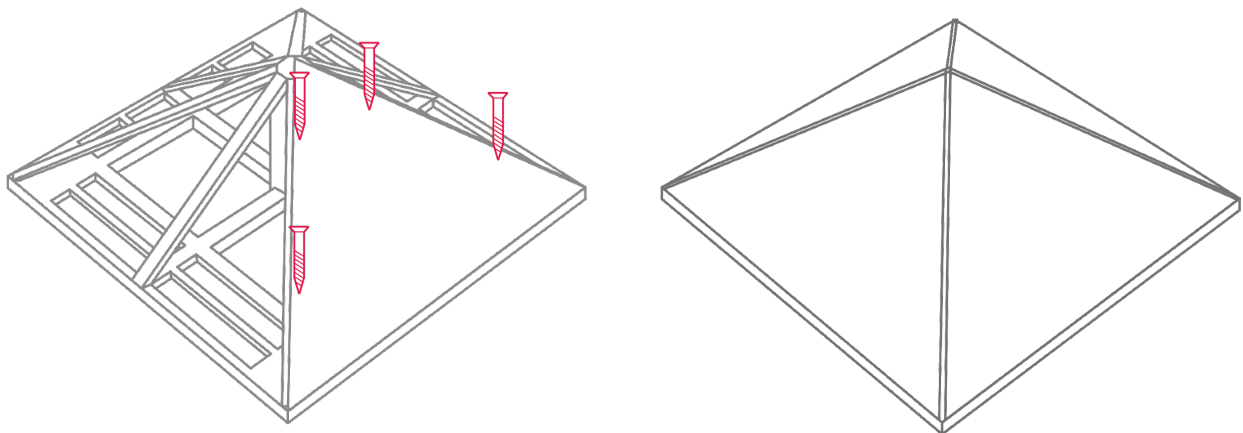

Figure D-3: Roofing Shingles

## Roof Sealing

Screw the corner roof shingles around all corners. Each corner will have two shingles curved upward to easily identify the position of the screws (Figure D-4).

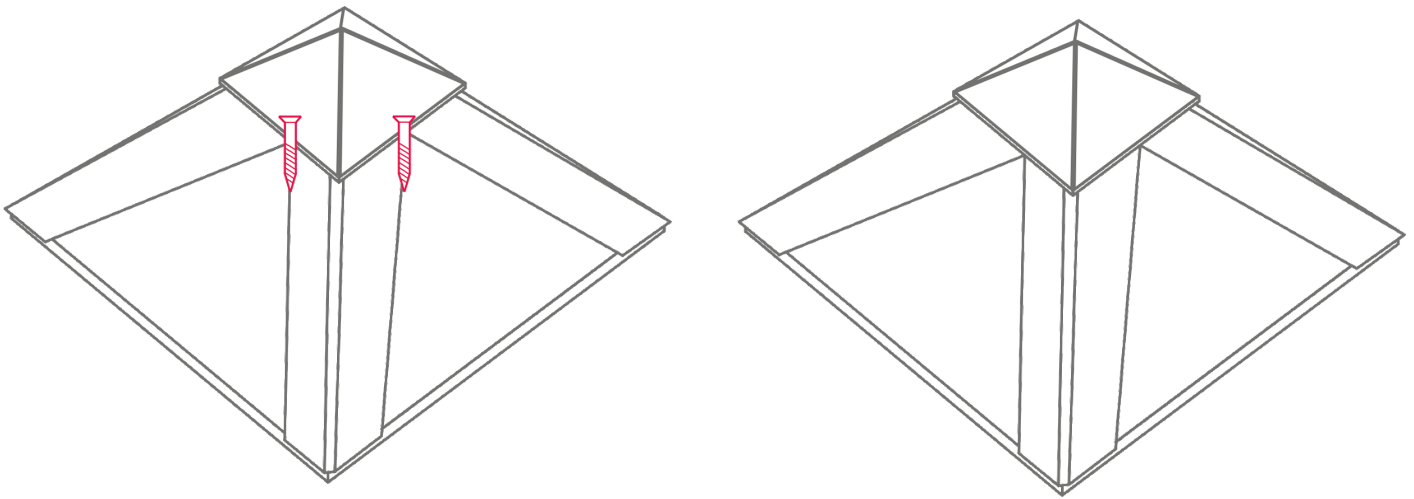

Figure D-4: Corner Roof Shingles

After screwing in the corners, flatten the curved shingles and place the pyramid roof shingles on top (Figure D-5).

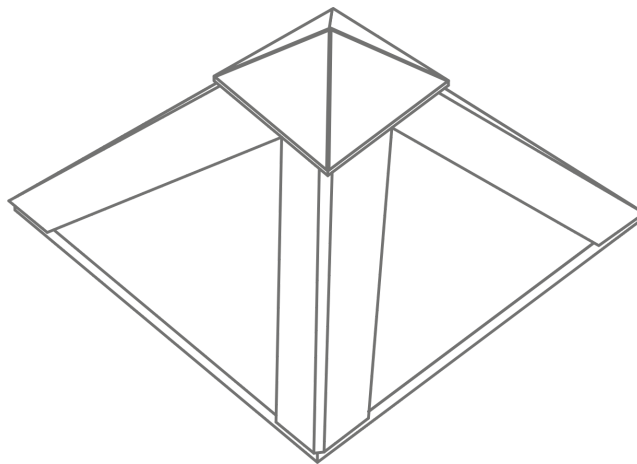

Figure D-5: Pyramid Roof Shingles

# Slope Roof

**CAUTION!**

**BEFORE PLACING THE SLOPE ROOF, MAKE SURE THAT EVERYTHING IS WORKING AND CONNECTED PROPERLY ON THE CEILING.**

If you had something damaged or had any issues, please call our technical department and wait till you get everything resolved and working properly before placing the roof. The roof is heavy and it will be hard to remove it in order to install parts.

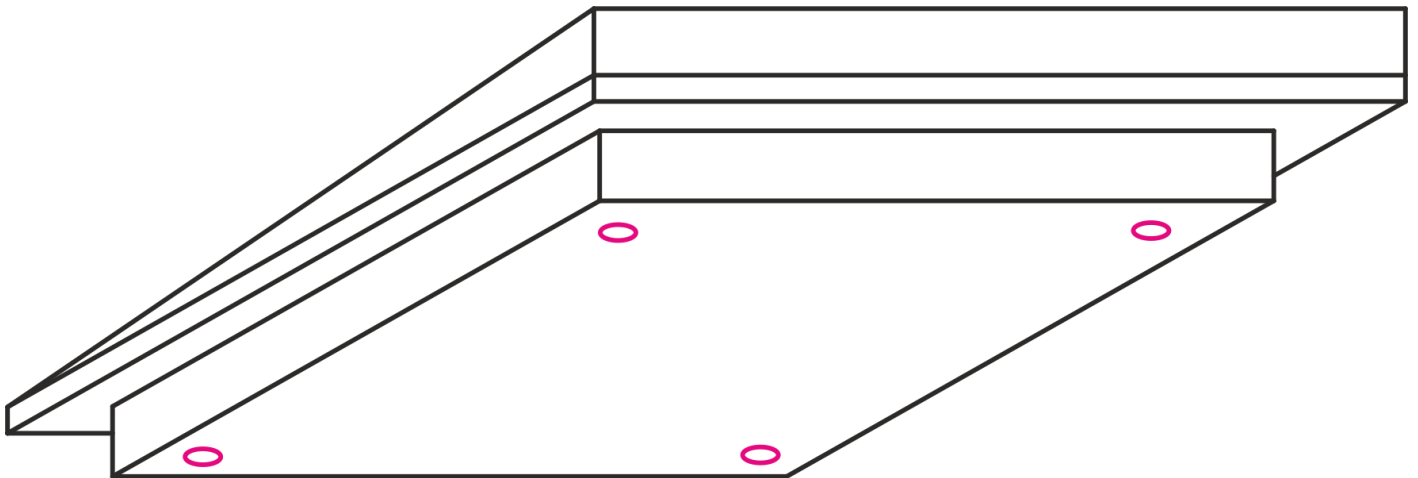



# Full Spectrum Heater Installation for Diamond Models

Step 1.

Locate the wooden bracket and full spectrum heater.

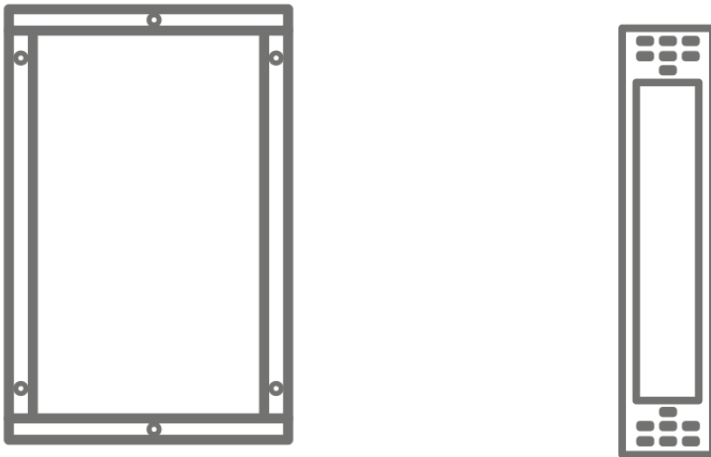

Step 2.

Align the holes from the wooden bracket to the holes on the back of the full spectrum heater.

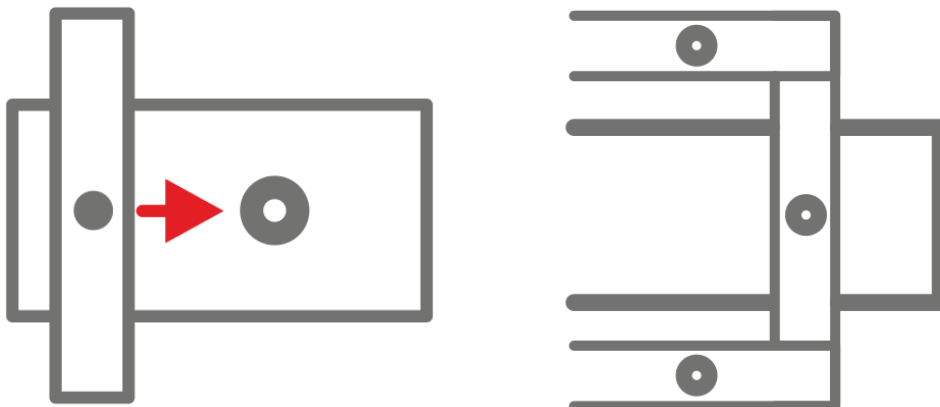

Step 3.

Screw on the bolt.

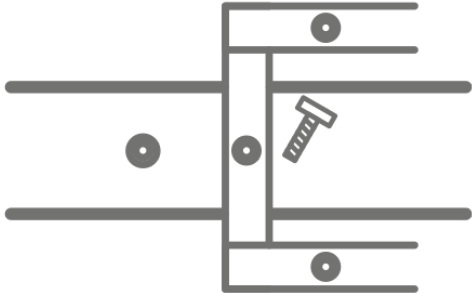

Step 4.

Place 2 full spectrum heaters on the front wall besides the door.

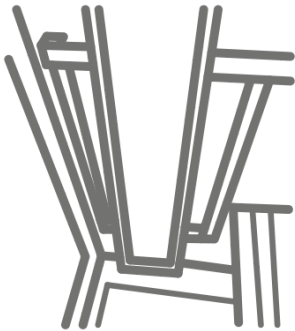

## ACCESSORIES

### Oxygen Ionizer (Recommended)

Locate the ionizer plug which is extended out of the sauna ceiling (1-pin plug). Connect the oxygen ionizer and screw it into the back panel.



### Cup Holder (Optional)

The cup holder is a small wooden table that can be screwed in one of the front corners (either right or left, based on the user preferences). Make sure not to install the cup holders on or in front of the heater. Some models with a glass front or corner saunas will not include the cup holder.

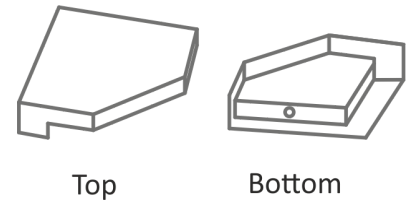

### Magazine Holder (Optional)

The magazine holder can be installed either on the front wall (in front of the window) or in the sidewall (next to the legs) (the placement of the magazine holder is optional based on the user preferences). Do NOT install the magazine holder in front of the heater. The magazine holder size might vary based on the model.



### Towel Rack (Optional)

For models with full glass doors, the towel rack can be installed either on the front wall or on the sidewall (the placement of the towel rack is optional based on the user preferences). Do NOT install the towel rack in front of the heater.

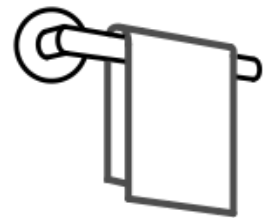

For models with glass and wooden frame doors or wooden doors, install the towel rack in the middle of the door frame and use it as a door handle.

**AM/FM RADIO/MP3 player, BLUETOOTH** The MP3 player will be pre-installed on the sauna. There are two parts to help to remove the MP3 player if needed (2 L-shaped metallic pieces – image on the right).



### Color Therapy Lights (Recommended)

Some models will include color therapy lights (or chromo lights aka chromotherapy). Color therapy lights function as light therapy for physical and mental health. Scientists have determined that each color emits a frequency.

Our body consists of Seven Layers of the Auric Field and the Seven Chakras (energy centers of the body). Each layer looks different and

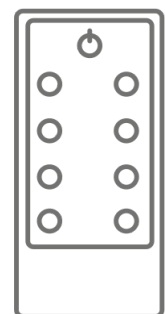



each has its own particular function. Each layer of our Aura is associated with a chakra (1st layer with 1st chakra, and so on). See a chart below:

### **Chakra – Root Chakra (RED)**

Location: The end of the spine, between the anus and the sexual organs

Function/Qualities: Security/Safety, Stability

Function when disturbed/unhealthy: Fear, insecurity. Life feels like a burden. Feeling of not belonging.

Physical Health: Weak constitution, elimination problems. Reduced physical and mental resistance.

### **2nd Chakra – Sacral Chakra (ORANGE)**

Location: The Sexual Organs

Function: patience, Healthy/Positive Emotions towards Sexuality, Creativity, Responsible Relations

Function when disturbed/unhealthy: Rigid emotions, frigidity, guilt, no boundaries.

Physical Health: Problems with reproductive organs, kidneys.

### **3rd Chakra – Navel (YELLOW)**

Location: Navel Point – Solar Plexus

Function/Qualities: Center of personal power and commitment;

Self-esteem, dignity, identity, judgment.

Place of inner balance and inspiration. Function when disturbed/unhealthy: Anger, greed, shame, despair;

No strength or spontaneity. Conforming in order to be recognized;

Suppressing one's own wishes/emotions to please others.

Physical Health: Problems with digestion, the liver, gallbladder, the pancreas.

### **4th Chakra – Heart Chakra (GREEN)**

Location: The middle of the chest on the breast bone.

Function/Qualities: Compassion, kindness, forgiveness, service, love

Function when disturbed/unhealthy: Grief, Attachment, Easily Hurt. Emotional dependence on others. Heartlessness.

Physical Health: Heart problems, lung problems, blood pressure problems.

### **5th Chakra – Throat Chakra (LIGHT BLUE)**

Location: The throat

Function/Qualities: Language; Ability to communicate effectively; Authenticity; Inspiring, teaching.

Function when disturbed/unhealthy: Lethargy, weakness in expressive abilities; Shyness, voice problems, insecurity, fear of others' judgments/opinions.

Physical Health: Throat, neck, thyroid problems.

### **6th Chakra – Third Eye (INDIGO BLUE)**

Location: Between the eyebrows.

Function/Qualities: High Intuition; Clairvoyance; Visualizing; Fantasizing; Concentration and determination; Self-Initiation; Power of projection; Understanding your purpose.

Function when disturbed/unhealthy: Confusion, Depression. Rejection of spirituality; Over-intellectualizing.

Physical Health: Depression, Panic, Mental Disorders.

### **7th Chakra – Crown Chakra (VIOLET)**

Location: Crown of the head.

Function/Qualities: Spiritual Connection; Connection to the Higher Self; Unity; Enlightenment; Universal Awareness

Function when disturbed/unhealthy: Grief; Feeling of being separated from existence/abundance. Fear of death. Mental Health: Complete separation and dis-illusion from oneself; grief, sadness, false/limiting beliefs.

### **8th Chakra – Aura (WHITE)**

Location: The electromagnetic field (contains all colors above)

Function/Qualities: Aura combines all the effects of the chakras and offers their projection. Aura projects and protects.

Function when disturbed/unhealthy: Shy, withdrawn, vulnerable.

Physical/Mental Health: Overall weakness in mind and body.

Operating Instructions:

The color lights are operated by remote control only. Press any color on the remote control to turn the lights on and select a color. You may then press the “Cycle” button (lower right button) to cycle through the colors randomly. Press the “Power” button to turn the lights off.

## **Control Panel Operating Instructions**

**V.1**

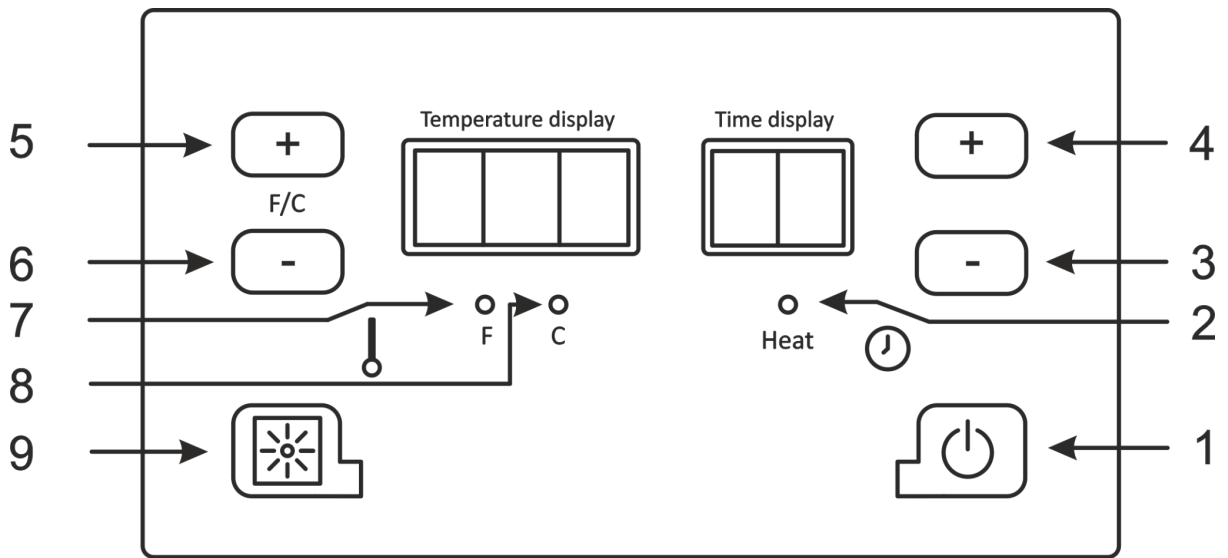

#	Function	#	Function
1	Power Button (On/Off)	6	Temperature Control (reduce)
2	Heat Light	7	Fahrenheit Light
3	Timer Control (reduce)	8	Celsius Light
4	Timer Control (increase)	9	Lights Button/Pause
5	Temperature Control (increase)		

## V.2

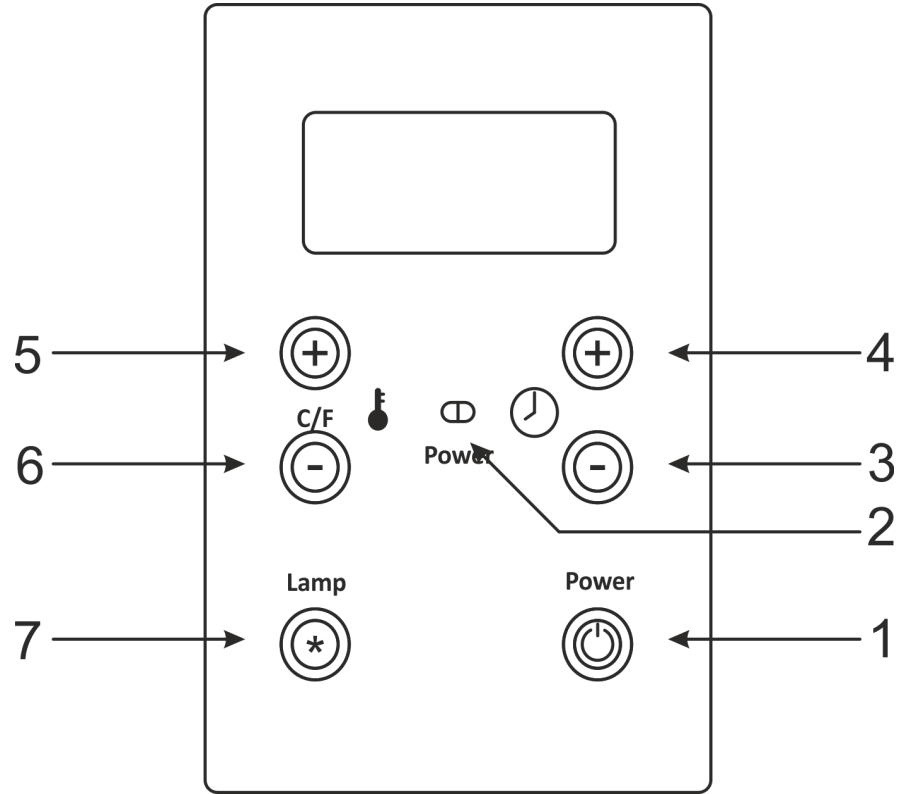

#	Function	#	Function
1	Power Button (On/Off)	5	Temperature Control (increase)
2	Power Light	6	Temperature Control (reduce)
3	Timer Control (reduce)	7	Lights Button/Pause
4	Timer Control (increase)		

### V.3

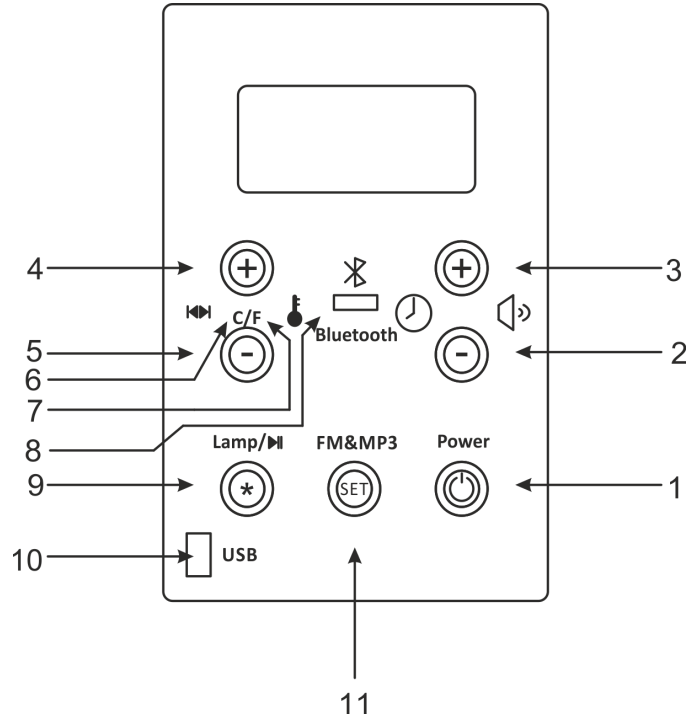

#	Function	#	Function
1	Power Button (On/Off)	7	Fahrenheit Light
2	Timer/Sound Control (reduce)	8	Bluetooth connected light
3	Timer/Sound Control (increase)	9	Lights Button/Pause
4	Temperature Control (increase)	10	USB connect interface
5	Temperature Control (reduce)	11	Settings control
6	Celsius Light		

## V.4

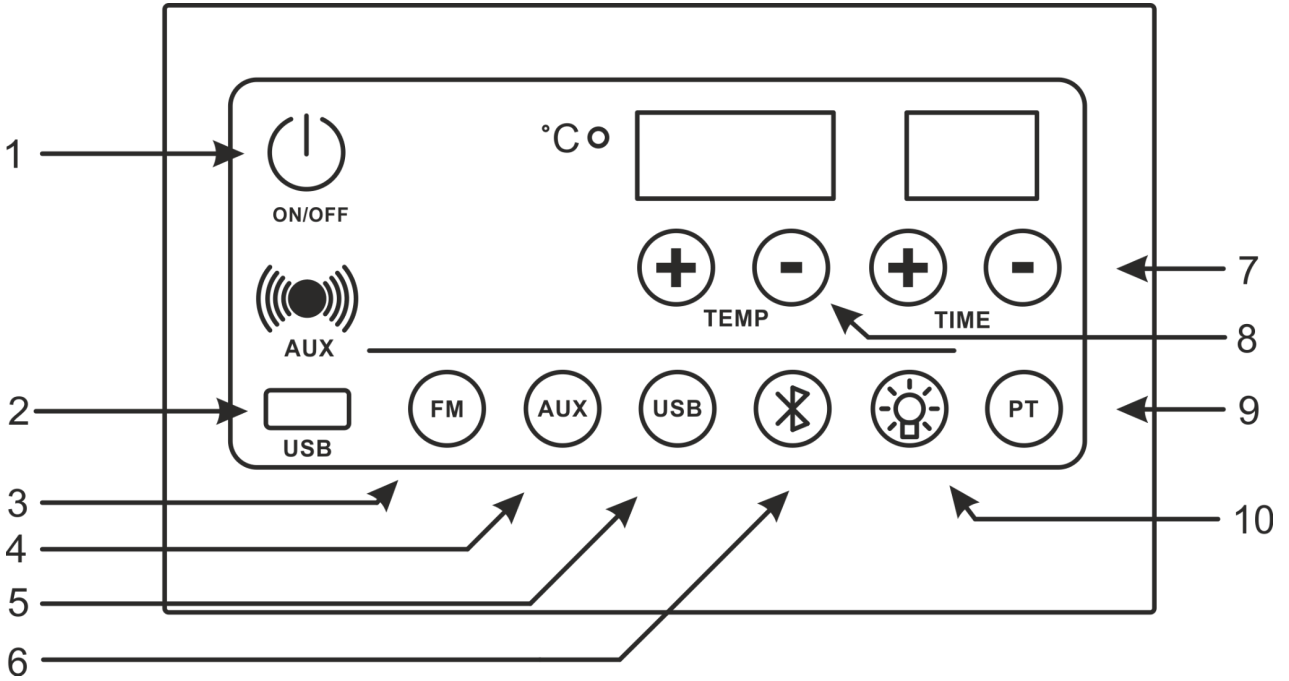

#	Function	#	Function
1	Power Button (On/Off)	6	Turn on Bluetooth button
2	USB connect interface	7	Set time buttons
3	Turn on the radio button	8	Set temperature buttons
4	Turn on the AUX function button	9	Set 45 °C on 60 minutes
5	Turn on USB function button	10	Lights Button/Pause

## V.5

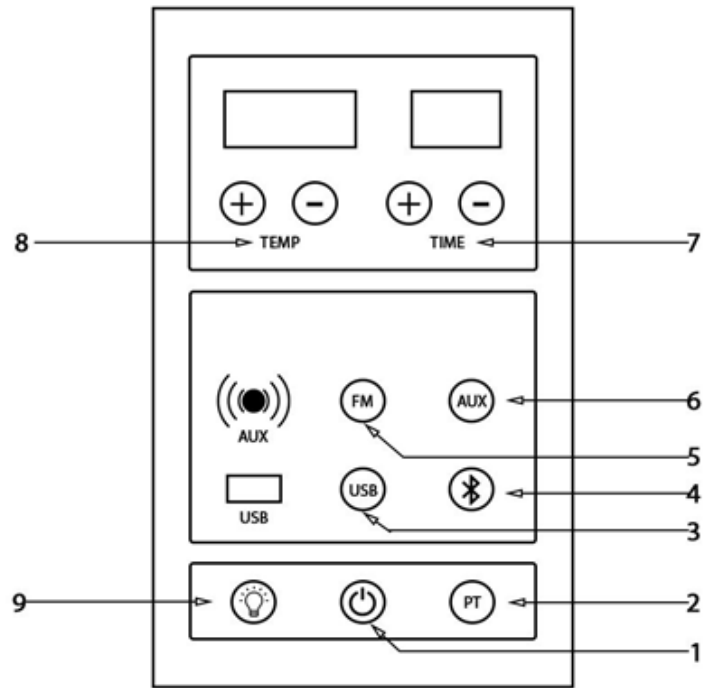

#	Function	#	Function
1	Power Button (On/Off)	6	Turn on the AUX function button
2	Set 45 °C on 60 minutes	7	Set time buttons
3	Turn on USB function button	8	Set temperature buttons
4	Turn on Bluetooth button	9	Lights Button/Pause
5	Turn on radio button		

### **1.Turn on the light wave.**

Click the "On/Off"(1) button to turn the light wave on or off. In the power-on state, The first click is to turn on the light wave, and the second click is to turn off the light wave. After setting the temperature (30-65), the system temperature has a memory function, and the last set temperature is the value. Time defaults to a maximum of 60 minutes

### **2.Temperature setting**

After turning on the light wave, click the temperature + and temperature - to adjust the temperature of the light wave, the temperature adjustment range is 30-65°C, Click once to increase or decrease by 1°C; when the temperature is lower than 30 degrees, the display is --

Fahrenheit and Celsius conversion: long press TEMP + button for 10 seconds, you can convert Fahrenheit and Celsius

### **3.Time setting**

The time can be adjusted from 5 to 60 minutes, click once to increase or decrease by 1 minute. When the countdown reaches 0 minutes, the buzzer will sound 3 times, each interval is 1.5S.

### **4.Lamp function**

1. When the light wave is turned on, click the "Lights"(9) button to switch the light. The light parameters are: AC220V 50W (if you need to use the DC12V lamp, please connect the external switching power supply)

2. When the light wave is turned on, click the "Lights"(9) button, when the clock area shows '2n', the temperature area displays "LX". Press the "Lights"(9) button to change the color of the LED light. Press once to convert one color, can cycle and remember (L1 full bright L2 red blue L3 blue L4 blue-green L5 green L6 green red L7 red L8 jump L9 gradient)

3. Do not press the "Lights"(9) button within 8 seconds, the time window exits 2n, the temperature window exits Lx, the color of the LED light retains the current state and exits the light control logic lock function.

4. In the 2n state, LED lights and high-voltage spotlights can be individually switched: tap time-and time+ can independently control switch LED lights and spotlights

### **5.Audio function (can be controlled independently):**

1. Press the "FM"(5) button to turn on the radio function, the temperature zone displays the frequency, the clock zone displays "XX", the time +/- adjusts the volume, the temperature +/- adjusts the frequency, and the button has no button response for 8 seconds, the display switches to temperature and time.

2. Press the "AUX"(6) key to turn on the AUX function, the temperature zone displays AUX, the clock zone displays "XX", the time +/- adjusts the volume, and the button has no button response for 8 seconds, the display switches to temperature and time.



3. Press the “USB”(3) button to open the USB function, the temperature zone displays USB, the temperature +/- adjusts the previous one, the next one, the clock area displays “XX”, the time +/- adjusts the volume, and the button has no button response for 8 seconds. , the display switches to temperature and time.

Note: The U disk read time is 2-3 seconds.

4. Click the “Bluetooth”(4) button, the backlight is on, and the Bluetooth is turned on. At this point, open Bluetooth on mobile devices, and search, complete Bluetooth matching, ready for success. After the pairing is successful, the song can be played. The pairing time is 6-7 seconds, the temperature zone displays “TB”, the clock zone displays “XXdb”, tap the time +/- to adjust the volume, 8 seconds without button response, the display switches to temperature and time.

Note: During the Bluetooth pairing process, Bluetooth, USB, and radio can't be switched immediately. The switching time should be 6-7 seconds. If you switch immediately, you can switch after 6-7 seconds.

#### **6. Physiotherapy function:**

In the boot state, press the "PT"(2) button, the sauna temperature is 45 degrees, the time is 60 minutes.

#### **7. High-temperature protection function:**

When the temperature of the sensor exceeds 75 degrees, the two digital tubes display HH at the same time, alarm and flicker, all functions stop, even if the temperature drops below 65 degrees, the function can not be restored, and must be power-off before normal use.

#### **8. Sensor fault detection:**

Open circuit: Two digital tubes display 00 and flicker, buzzer alarm, the function can not be turned on normally, after troubleshooting can be used normally.

Short circuit: Two digital tubes display 11 and flicker, buzzer alarm, the function can not be turned on normally, after troubleshooting can be used normally.



## Usage Guide

Allow your sauna to warm up for 15-20 minutes or until it reaches 110 F° (43 ° C). You may close the vent on the ceiling to speed up the preheating process. Drink plenty of water to avoid dehydration before and after the sauna session. It is recommended not to exceed 40 minutes per session.

If the sauna becomes stuffy, open the vent on the ceiling to allow fresh air into the sauna.

Tip:

- Start using the sauna within 10 degrees before it reaches the set temperature, in order to receive the most benefit out of the infrared heaters. For example, if you set the sauna to 125 F° (52 ° C), you should start using the sauna when it reaches 115 F° (46 ° C).
- Customers reported an average use temperature of 125 F° (52 ° C).

### Precautions and Warnings!

- If the temperature becomes unbearable, decrease the temperature or shut off the sauna immediately.
- Do not use it if pregnant or have serious inflammation, fever, a communicable disease, acute bleeding, or are intoxicated.
- Do not consume alcohol or drugs when using the sauna.
- Do not splash water on the heaters or any electrical component inside the sauna.
- Do not bring wet towels into your sauna or any substances that could harm the interior of your sauna.
- Do not install a lock on your sauna.
- All repairs need to be authorized by the supplier 's representative; otherwise, the product warranty may be voided.



## Sauna and Contraindications

### Sauna and Medications

Individuals who are using prescription drugs should seek the advice of their personal physician or pharmacist for possible changes in the drug's effect when the body is exposed to far-infrared waves or elevated body temperature. Diuretics, barbiturates, and beta-blockers may impair the body's

natural heat loss mechanisms. Some over the counter drugs such as antihistamines may also cause the body to be more prone to heatstroke.

### **Sauna and Children**

The core body temperature of children rises much faster than adults. This occurs due to a higher metabolic rate per body mass, limited circulatory adaptation to increased cardiac demands and the inability to regulate body temperature by sweating. Consult with the child's Pediatrician before using the sauna. Sauna is NOT recommended for small children!

### **Sauna and the Elderly**

The ability to maintain core body temperature decreases with age. This is primarily due to circulatory conditions and decreased sweat gland function. The body must be able to activate its natural cooling processes in order to maintain core body temperature. Please consult with your physician prior to use.

### **Sauna and Cardiovascular Conditions**

Individuals with cardiovascular conditions or problems (hypertension/hypotension), congestive heart failure, impaired coronary circulation or those who are taking medications, which might affect blood pressure, should exercise extreme caution when exposed to prolonged heat. Heat stress increases cardiac output, blood flow, in an effort to transfer internal body heat to the outside environment via the skin (perspiration) and respiratory system. This takes place primarily due to major changes in the heart rate, which has the potential to increase by thirty (30) beats per minute for each degree increase in core body temperature.

### **Sauna and Alcohol**

Contrary to popular belief, it is not advisable to attempt to "Sweat Out" a hangover. Alcohol intoxication decreases a person's judgment; therefore they may not realize it when the body has a negative reaction to high heat. Alcohol also increases the heart rate, which may be further increased by heat stress.

### **Sauna and Chronic Conditions / Diseases Associated With a Reduced Ability to Sweat or Perspire**

Parkinson's, Multiple Sclerosis, Central Nervous System Tumors and Diabetes with Neuropathy are conditions that are associated with impaired sweating.

### **Sauna and Hemophiliacs / Individuals Prone To Bleeding**

The use of Infrared saunas should be avoided by anyone who is predisposed to bleeding.

### **Sauna and Fever**

An individual that has a fever should not use any type of sauna.

## Sauna and Insensitivity to Heat

An individual that has an insensitivity to heat should not use any type of sauna.

## Sauna and Pregnancy

Pregnant women should consult a physician before using any type of sauna because fetal damage can occur with certain elevated body temperature. Therefore, the sauna is NOT RECOMMENDED for use by pregnant women.

## Sauna and Menstruation

The heating of the low back area of women during the menstrual period may temporarily increase their menstrual flow. Some women endure this process to gain pain relief commonly associated with their cycle whereas others simply choose to avoid saunas use during that time of the month.

## Sauna and Joint Injury

If you have a recent (acute) joint injury, it should not be heated for the first 48 hours after an injury or until hot and swollen symptoms subside. If you have a joint or joints that are chronically hot and swollen, these joints may respond poorly to vigorous heating of any kind. Vigorous heating is strictly contraindicated in cases of enclosed infections, be they dental, in joints or in any other tissues.

## Saunas and Implants

Metal pins, rods, artificial joints or any other surgical implants generally reflect far infrared waves and thus are not heated by this system; nevertheless, you should consult your surgeon prior to using an Infrared Sauna. Certainly, the usage of an Infrared Sauna must be discontinued if you experience pain near any such implants. Silicone does absorb far infrared energy. Implanted silicone or silicone prostheses for nose or ear replacement may be warmed by the far-infrared waves. Since silicone melts at over 200°C (392°F), it should not be adversely affected by the usage of Infrared saunas. It is still advised that you check with your surgeon and possibly a representative from the implant manufacturer to be certain.

In the rare event, you experience pain and/or discomfort, immediately discontinue sauna use.



## Troubleshooting

### The sauna doesn't power on:

- Make sure the power cord is securely connected to the power socket and the control box (on top of the sauna).
- Make sure the breaker did not turn off.
- Make sure the control panel white ribbon wire is securely connected.
- Make sure the power socket is working by trying a different device on the same socket.

### **Light is not working:**

- Replace the light bulb.

### **Color therapy light does not work:**

- Make sure the battery is inserted correctly.
- Make sure to point the remote directly at the remote receiver (small rounded tip next to the color lights).
- Try a new battery.

### **All heaters are not working:**

- Make sure to connect the heater plugs are connected securely to the control box (on top of the sauna).
- Make sure to connect the heaters' plugs under the bench are connected securely.
- Floor heater and under bench heater are not as hot as other heaters (by design).
- Make sure the plug behind the heater is connected (you would need to unscrew the heater).

### **Control panel display is unusual:**

- If the control panel temperature display is over 150 or 230, make sure to connect the heat sensor securely.
- If the control panel time display is -- (two dashes), the sauna is in continuous working mode. Press the timer button to return to the timed working mode.

### **FM/USB/AUX/MP3/BLUETOOTH PLAYER WITH SPEAKERS is not working:**

- If the radio has bad reception, extend the antenna outside the sauna roof.
- If the USB cannot read an MP3 player, use an Aux-In plug and play the music from the MP3 player.

For more troubleshooting advice or to report a problem, please contact the supplier.



## **Warranty Information**

Enlighten Saunas warrants its products to be free of defects in material and workmanship.

This warranty extends only to:

1. a retail purchaser of a sauna or parts directly from the supplier;
2. the authorized wholesale purchaser of a sauna or parts directly from the supplier; or
3. a retail purchaser of a sauna or parts from an authorized wholesaler.

However, in the event of a sale, transfer or conveyance of a sauna or parts from any of the three (3) proceeding persons or entities, any rights, duties, and obligations associated with this warranty shall be null and void and of no further force and effect. The sauna or parts must be purchased and used within one year of the manufactured date.

The controls, heaters, electrical parts and wiring must be kept dry at all times and not exposed to any water or liquids.

Under no circumstances will the manufacturer be liable for any special or consequential damages arising from the use of the product, its components and/or parts installed with or attached to it. The manufacturer is not liable for any injury to any persons or any claims of such that may be arising from the use, installation, and/or the service (repair) of the product.

The purchaser must establish the date of purchase, by dated sales slip, invoice or delivery receipt.

## Outdoor-Residential Use:

A warranty shall not apply to any product or a component used for any industrial, rental, professional or neglect, accident, abuse, improper installation and/or reckless operation by the purchaser, including but not limited to: exposure to a fire or excessive heat, and other hazardous elements/activities. (Please refer to an instruction manual on proper usage).

### Standard Warranty

**The standard 3-year warranty covers the following:**

- Factory-Installed Heater Components - 3 years
- Factory-Installed Sauna Controls and Wiring- 3 years
- Factory-Installed Audio Components - 3 years
- Enlighten Saunas® Brand Cabin (Wood / Construction) - 3 Years

### Extended Warranty

#### 5 years optional

**You can extend for an additional 5% of the MSRP price of the sauna. This amount must be paid within 90 days of the date of delivery**

- Factory-Installed Heater Components - 5 years
- Factory-Installed Sauna Controls and Wiring - 5 years

- Factory-Installed Audio Components - 5 years
- Enlighten Saunas® Brand Cabin (Wood / Construction) - 5 years

## Extended Warranty 10 years optional

**You can extend for an additional 10% of the purchase price of the sauna. This amount must be paid within 90 days of the date of delivery**

- Factory-Installed Heater Components - 10 years
- Factory-Installed Sauna Controls and Wiring - 10 years
- Factory-Installed Audio Components - 10 years
- Enlighten Saunas® Brand Cabin (Wood / Construction) - 10 years

## Lifetime Optional

**You can extend to a lifetime warranty for an additional 20% of the purchase price of the sauna. This amount must be paid within 90 days of the date of delivery**

- Infrared Heaters - Lifetime
- Factory-Installed Sauna Controls and Wiring - Lifetime
- Factory-Installed Audio Components - Lifetime
- Enlighten Saunas® Brand Cabin (Wood / Construction) - 10 years

For the coverage period specified (“warranty period”), Company agrees to replace, at its sole option, the products listed above, subject to and solely in accordance with the terms, conditions, exclusions, and limitations set forth herein. The warranty covers parts only, labor is not included.

## Indoor-Residential Use:

The sauna or parts must be placed in an indoor environment unless the sauna or parts are specifically bought for outdoor/indoor use. If an indoor sauna or parts are placed in an outdoor environment, the warranty shall be null and void and of no further force and effect.

A warranty shall not apply to any product or a component used for any industrial, rental, professional or neglect, accident, abuse, improper installation and/or reckless operation by the purchaser, including but not limited to: exposure to a fire or excessive heat, and other hazardous elements/activities. (Please refer to an instruction manual on proper usage).

## Standard Warranty

**The standard warranty covers the following:**

- Factory-Installed Heater Components - 7 years
- Factory-Installed Sauna Controls and Wiring- 7 years
- Factory-Installed Audio Components - 7 years
- Enlighten Saunas® Brand Cabin (Wood / Construction) - 7 years

## Lifetime Optional

**You can extend to a lifetime warranty for an additional 10% of the purchase price of the sauna. This amount must be paid within 90 days of the date of delivery**

- Infrared Heaters - Lifetime
- Factory-Installed Sauna Controls and Wiring - Lifetime
- Factory-Installed Audio Components - Lifetime
- Enlighten Saunas® Brand Cabin (Wood / Construction) - 10 years

For the coverage period specified (“warranty period”), Company agrees to replace, at its sole option, the products listed above, subject to and solely in accordance with the terms, conditions, exclusions, and limitations set forth herein. The warranty covers parts only, labor is not included.

## Commercial Use:

### Standard Warranty

**The standard 3-year warranty covers the following:**

- Factory-Installed Heater Components - 3 years
- Factory-Installed Sauna Controls and Wiring- 3 years



- Factory-Installed Audio Components - 3 years
- Enlighten Saunas® Brand Cabin (Wood / Construction) - 3 Years

## Extended Optional

### 6 years Optional

**You can extend for an additional 20% of the purchase price of the sauna. This amount must be paid within 90 days of the date of delivery**

- Factory-Installed Heater Components - 6 years
- Factory-Installed Sauna Controls and Wiring - 6 years
- Factory-Installed Audio Components - 6 years
- Enlighten Saunas® Brand Cabin (Wood / Construction) - 6 years

For the coverage period specified (“warranty period”), Company agrees to replace, at its sole option, the products listed above, subject to and solely in accordance with the terms, conditions, exclusions, and limitations set forth herein. The warranty covers parts only, labor is not included.

The warranty covers manufacturing defects in materials and workmanship encountered in normal use of this product, and shall not apply to the following, including, but not limited to: damage which occurs in shipment; delivery and installation; applications and uses for which this product was not intended; altered product or serial numbers; cosmetic damage or exterior finish; accidents, abuse, neglect, fire, water, lightning or other acts of nature; use of products, equipment, systems, utilities, services, parts, supplies, accessories, applications, installations, repairs, external plumbing and leaks, external wiring, circuit breakers, fuses or connectors not supplied and authorized by the supplier, or which damage this product or result in service problems; incorrect electrical line voltage, fluctuations, and surges; customer adjustments and failure to follow operating instructions, cleaning, maintenance and environmental instructions that are covered and prescribed in the instruction book; consumable items including light bulbs.

Enlighten Saunas® shall not be liable for the loss of use of the sauna or other incidental or consequential damages. Under no circumstances shall the supplier or any of its representatives be held liable for injury to any persons or damages to any properties. Specifications are subject to change without notice.

Enlighten Saunas® uses the highest quality wood in our product lines. All structures using wood are susceptible to minor dents, scratches, and scuffing. This is normal and will not affect the integrity or operation of your sauna.

Wood is a living material that continues to respond to climate conditions, even after being manufactured into a sauna. Variations in color or grain, and irregularities such as fine cracks are part of the natural beauty of the wood and in no way should be considered defects. During normal operation, wood may crack slightly due to the changes in moisture level. This will not affect the structural integrity of the sauna.

Prior to shipping, the wood is inspected for consistency, color, and quality. Our saunas are shipped around the globe and can experience slight blemishes, scratches or scuffs in transit. In most cases, these blemishes on the exterior of the sauna can be concealed by using a small amount of furniture polish, oil or other furniture treatment. The interior blemishes, scratches, or scuffs can be either left alone, sanded or a combination of gluing plus sanding. Please avoid any treatment containing benzene or a high concentration of alcohol.

### **ATTENTION:**

Shipping damage must be notated on the Bill of Lading (BOL). The Supplier must be notified of any damage to your sauna within three (3) business days of signing the BOL. Failure to notify the supplier within the established time frame will result in the owner taking full responsibility for the cost of ALL REPLACEMENT PARTS including shipping and handling fees.



## **Sauna's Health Benefits**

### **Detoxification and Body Cleansing**

Detoxification is a bodily process that removes health-threatening toxic waste that is accumulated by our body from our environment, day-to-day stress, diet, and chemicals. Sweating is the body's natural way of getting rid of harmful toxins and cleansing our bodies by extracting poisons out through the skin. The infrared sauna waves penetrate deep below the skin and heat up the body's core temperature which naturally supports detoxification.

### **Weight Loss**

Infrared Sauna is an effective way to support any weight loss program. According to the Journal of the American Medical Association, a sauna session can burn between 300-700 calories. Also, Dr. Oz. explained in the Oprah show that an infrared sauna session can burn up to 700 calories. A 20-minute sauna session is equal to a 20-minute long jog run. However effective, please keep in mind that a healthy diet and exercise are recommended whether you use an infrared sauna or not. Sauna simply enhances weight loss results and may speed up the weight loss process. Note: Following a healthy

diet and exercise is highly recommended. Please always consult with your physician before attempting to begin any type of weight loss program.

### **Pain and Arthritis Relief**

Infrared waves penetrate deep into the muscles for long-lasting pain relief. Moreover, patients with rheumatoid arthritis, using an infrared sauna results in a short-term improvement regarding pain and stiffness, reduction in fatigue, and a trend towards long-term beneficial effects.

### **Skin Purification**

Infrared sauna purifies and rejuvenates the skin. It may assist in acne reduction, toning, and detoxification of skin cells. Sauna heat also relaxes facial tension, thus improving the skin's elasticity. Sweating rinses bacteria out of the epidermal layer and sweat ducts.

### **Cardiovascular Workout**

Scientific research has proven that regular use of infrared sauna dilates blood vessels, therefore, may prevent blood clots while maintaining healthy circulation and blood pressure. Vessels become more elastic and pliable longer due to the regular dilation and contraction from the process of heating and cooling the body repeatedly.

### **Lower Blood Pressure and Improved Circulation**

Blood vessel dilation brings blood closer to the surface of the skin and, as blood vessels expand to accommodate increased blood flow, circulation in the extremities improves, and the blood pressure gets lower. The effect on blood pressure is temporary, but medical research shows that frequent sauna bathing can make a person's blood pressure level also stay lower. Please note: a healthy diet and exercise are highly recommended. Always consult with your physician.

### **DISCLAIMER:**

The Sauna and its affiliates do not provide medical advice, education or treatment. The information contained in this manual is for general information purposes only and does not address individual circumstances or medical conditions. It may not be right for you and should not be relied upon in making decisions about your health. Always consult your doctor for medical advice.