



BigBattery.com
Your Source For Power

48V RHINO

(FWRHN-48140-G1)



USER MANUAL

INSTALLATION GUIDE

Version 1.0

Table of Contents

1. Introduction	2
2. Applications & Features	2
3. Product Specifications	3
3.1. Battery Specs	
3.2. Safety & Connections	4
3.3. BMS Specs	5
4. Warnings & Precautions	7
5. Installation	8
5.1. Parts & Components	8
5.2. Wall Mount	10
5.3. Floor Stand	14
6. Battery Interface	17
6.1. Overview	17
6.2. BMS Codes	18
7. Recycling	18
8. Warranty & Returns	19

1. Introduction

Introducing BigBattery's RHINO! The 48V RHINO is the World's Thinnest Wall-Mountable Battery. It is also the Largest Capacity Wall-Mountable Battery. Utilizing Lithium Iron Phosphate (LFP), Razor cell technology, this is the safest battery in the global market. This User Manual is designed to provide you with an understanding of the specs, features, capabilities, and installation of this 14 kilowatt-hour, 276 amp-hour battery. Read and take note of all safety information prior to installing or operating your battery. This document applies only to the BigBattery 48V RHINO – FWRHN-48140-G1.

2. Applications & Features

Applications:

- Solar
- Home
- Cabin Off-Grid
- Emergency Power

Features:

- Advanced BMS (Battery Management System)
- Advanced Razor-Cell Lithium-Ion LiFePO4/LFP Technology
- Wide temperature range
- Active Fire Suppression system (to protect from external fires)
- Easy connection to a larger power system
- Multiple layers of safety and protection
- Large, User Friendly, standard 175-amp connector for battery power source

BigBattery's 48V RHINO battery is the ultimate solution for your solar systems, off-grid power systems, emergency power supply, and more. The RHINO comes equipped with an advanced BMS, and the newest cell technology, allowing it to operate safely within a much wider temperature range. It can be charged quickly, and stored safely, at temperatures as low as -20 °C (-4 °F), as well as discharge at -30 °C (-22 °F). These temperatures are much colder than all other LFP batteries. The RHINO is the Longest Lasting Battery, that will last you 5,000 – 8,000 Complete Full Charge/Discharge Cycles. The battery utilizes a standard 175-amp connector, which provides a safe, and very secure connection to your battery unit. The RHINO is engineered to accommodate two different methods for installation: Both wall mounting and floor storage.

3. Product Specifications

3.1 Battery Specs

Parameter	Specification	Unit
Chemistry	Lithium Iron Phosphate, LFP	LiFePO4
Cell Configuration	16S	n/a
Nominal Voltage	48	Volts (DC)
Capacity (Ah)	276	Amp-hours
Capacity (kWh)	14	Kilowatt-hours
Operating Voltage Range	43 – 58.8	Volts (DC)
Charging Voltage Range	55.6 - 58.0	Volts (DC)
Max Charging Voltage	58.8	Volts (DC)
 WARNING: Do NOT exceed max charging voltage.		
Charging Current Limit (Continuous)	90	Amps
Discharging Current Limit (Continuous)	150	Amps
Max Peak Discharge Current (Over 6 seconds)	350	Amps
Charge Temp Range	-20 - 65 (-4 - 149)	°C (°F)
Discharge Temp Range	-30 - 65 (-22 - 149)	°C (°F)
Optimal Discharge Temp Range	15 - 35 (59 - 95)	°C (°F)
Storage Temperature Range (Max 6 months) (Humidity < 90%)	-20 - 35 (-4 - 95)	°C (°F)
Optimal Storage Temp Range	15 - 35 (59 - 95)	°C (°F)
Weight	132 (290)	kg (lb)
Length	110 (43.3)	cm (in)
Width	11.2 (4.4)	cm (in)
-	-	-
Width with Wall Mount	14.5 (5.7)	cm (in)
Height	67.8 (26.7)	cm (in)

3.2 Safety & Connections

- **Safety**
 - **BMS (Battery Management System)**
 - **Over Voltage Protection**
 - **Under Voltage Protection**
 - **Overcurrent Protection**
 - **Thermal Management System**
 - **300A Fuse**

- **Battery Connections**
 - **Series: NOT SERIES CAPABLE**
 - **Parallel: Maximum of eight (8) battery units connected in parallel**

3.3 BMS Specs









Category	Function	Specification	Unit
Charge Voltage Protection	Maximum Charger Voltage (CC-CV)	58.8	Volts (DC)
	Overcharge Voltage Limit Cutoff Protection (each cell)	3.8	Volts (DC)
	Overcharge Voltage Limit Protection Delay Time	2000	Milliseconds
	Overcharge Protection Recovery Voltage	3.45	Volts (DC)
Discharge Voltage Protection	Low Voltage Protection Limit Range	2.5 - 2.7	Volts (DC)
	Low Voltage Protection Delay Time	2000	Milliseconds
	Low Voltage Protection Recovery	2.9	Volts (DC)
Overcurrent Protection	Charge Overcurrent Protection Value Range	270 - 330	Amps
	Charge Overcurrent Delay	30	Seconds
	Charge Overcurrent Release Recovery Condition	Reconnection delayed 120 seconds	
	Scenario 1: Discharge Overcurrent Protection	300	Amps
	Scenario 1: Discharge Overcurrent Protection Delay	30	Seconds
	Scenario 2 (Short Circuit): Discharge Overcurrent Protection Range	800 - 1200	Amps
	Scenario 2 (Short Circuit): Discharge Overcurrent Protection Delay Range	600 - 1800	Milliseconds
	Discharge Overcurrent Protection Recovery Condition	Reconnection delayed 120 seconds	

Category	Function	Specification	Unit
Balance Function	Minimum Cell Voltage to Activate Cell Balancing	3.35	Volts (DC)
	Voltage Difference to Activate Cell Balancing	10	Millivolts (DC)
	Balancing Mode	Balance when charging	
	Balancing Current Range	100 - 260	Milliamps
Temperature Protection	High Temperature Protection Value when Charging	65 (149)	°C (°F)
	High Temperature Protection Release Value when Charging	55 (131)	°C (°F)
	Low Temperature Protection Value when Charging	-22 (-7.6)	°C (°F)
	Low Temperature Protection Release Value when Charging	-18 (-0.4)	°C (°F)
	High Temperature Protection Value when Discharging	75 (167)	°C (°F)
	High Temperature Protection Release Value when Discharging	65 (149)	°C (°F)
	Low Temperature Protection Value when Discharging	-30 (-22)	°C (°F)
	Low Temperature Protection Release Value when Discharging	-27 (-16.6)	°C (°F)
Resistance	Resistance in the Discharge Circuit Range	5 - 10	Milliohms
Self-Power Consumption	Operating Mode Range (relay closed)	35 - 50	Microamps
	Sleep Mode	0.5	Microamps
	Sleep Conditions	No current, communication, or prolonged protection states	
	Time to Sleep Mode	18 hours	





4. Warnings & Precautions

LFP is an inherently safe chemistry. However, safety measures should always be taken. Adhere to the instructions in this manual for safe handling and operation.

Warnings:

-  Indoor use only.
-  Do not charge with a charge voltage above 58.8V.
-  Do not charge nor discharge battery when ambient temperature is above 65 °C (149 °F).
-  Do not install battery where it may contact conductive materials, water, seawater, strong oxidizers, nor strong acids.
-  Do not install battery in a location exposed to direct sun, hot surfaces, nor hot locations. Do not install batteries in a tight clearance compartment, overheating may result.
-  Keep any flammable/combustible material (e.g. paper, cloth, plastic, etc.) that may be ignited by heat, sparks, flames, or any other heat source at a minimum distance of two feet away from the batteries.
-  Disconnect batteries immediately if, during operation or charging, they emit an unusual smell, develop heat, or behave abnormally.
-  Have a Class ABC or Class BC fire extinguisher on the premises.

Precautions:

-  Handle batteries and/or battery-powered devices cautiously to not damage the battery casing or connections.
-  Do not charge battery if ambient temperature is below -20 °C (-4 °F), nor discharge battery if ambient temperature is below -30 °C (-22 °F).
-  Before storing battery for more than 6 months, charge the battery to 53V or above.
-  For long-term storage, disconnect batteries from your power system.
-  Always wear protective gear when handling batteries.

- ⚠ Do not place any objects on top of batteries.
- ⚠ Make sure all cable connections are properly tightened.
- ⚠ Install and remove batteries using the handles provided.





Installation Safety Guidelines:







- Inspect batteries upon receipt for any signs of damage before use.
- Check to ensure that all cables are in good condition.
- Use a screwdriver with a rubber coated handle.
- When your battery has come to maximum charge (up to 58.8V max.), you may see a slight voltage drop immediately or within an hour after unplugging. This is normal and should be no cause for concern.

5. Installation

⚠ WARNING: Before installing, make sure to review all safety guidelines, warnings, and precautions in Section 4.

5.1 Parts & Components

General	
RHINO (1) (WR) 110 x 11.2 x 67.8 cm (43.3 x 4.4 x 26.7 in)	
Standard 175-amp connector to Ring Terminal Cable (1) (SB) 101.6 cm (40 in)	
Rope Handles (2) (RH) 56.4 cm (22.2 in)	
Flat Top Screws (4) (FS) 1.3 cm (0.5 in)	

Wall Mount Option	
Mounting Crossbars (2) (A1 & A2) 90.9 cm (35.8 in)	
Spreader Bars (2) (B1 & B2) 57.8 cm (22.75 in)	
Mounting Screws (6) (M8 X 60) (brick/concrete) (MS1) 5.8 cm (2.3 in)	
Mounting Screws (6) (drywall/wood) (MS2) 7 cm (2.75 in)	
Floor Stand Option	
Floor Stand (1) (FLS) 110 x 29.9 x 82.6 cm (43.3 x 11.75 x 32.5 in)	
Crossbar Plates (2) (CP) 11 cm (4.33 in)	
Pan Screws (4) (PS) 1.9 cm (0.75 in)	

5.2 Wall Mount

Step 1:

If installing onto wood-studded drywall:

1. Choose the height you would like to install the battery and locate studs with a stud finder where you will mount the top cross bar (A1).
2. Use a small drill bit to find the edges of the stud by drilling several small holes horizontally.
3. Mark the center of the studs with a small vertical line.
4. Make another set of marks denoting the center of the studs 55.3 cm (21.75 in) below your original markings. These will be for your second mounting bar (A2).
5. Place and level the first cross bar (A1) to line up the holes in the first cross bar (A1) with the center stud marks.
6. Level and fasten first mounting cross bar (A1) onto the wall where you will be installing your RHINO using the MS2 screws provided. This will be the top crossbar of your wall mount

If installing onto brick or concrete wall:

1. Choose the height you would like to install the battery.
2. Place and level the top cross bar (A1).
3. In each of the holes on the first cross bar (A1), mark the wall.
4. Make another set of marks denoting the center of the studs 55.3 cm (21.75 in) below your original markings. These will be for your second mounting bar (A2).
5. Drill holes into the wall over each marking, and place the anchor portion of each of your mounting screws (MS1) in each hole.
6. Place the first cross bar (A1) so it lines up with your drilled and anchored holes.
7. Level and fasten first mounting cross bar (A1) onto the wall where you will be installing your RHINO using the MS1 screws provided, as seen in Figure 1. This will be the top crossbar of your wall mount.

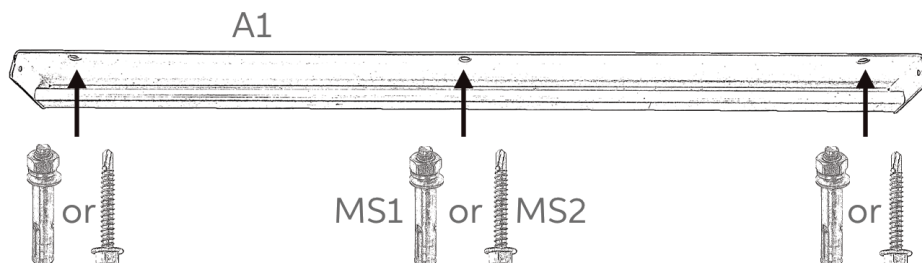

Fig. 1

(Make sure to use the appropriate mounting screw - MS1 or MS2 - for the material you will be mounting to)

Step 2:

If installing onto wood-studded drywall:

1. Place and level the second mounting crossbar (A2) on the wall exactly 55.245 cm (21.75 in) (bottom of A1 to bottom of A2) below the top crossbar (A1). Use the spreader bars (B1 & B2) to determine appropriate distance, as seen in Figure 2.
2. Ensure the holes of the second mounting crossbar (A2) line up with the markings made in Step 1.
3. Once position is set, mount second crossbar (A2) to wall using the MS2 screws provided, as seen in Figure 1. This will be the bottom crossbar of your wall mount.

If installing onto brick or concrete wall:

1. Drill holes into the wall over each marking made in Step 1, and place the anchor portion of each of your mounting screws (MS1) in each hole.
2. Place and level the second mounting crossbar (A2) on the wall exactly 55.3 cm (21.75 in) (bottom of A1 to bottom of A2) below the top crossbar (A1). Use the spreader bars (B1 & B2) to determine appropriate distance, as seen in Figure 2.
3. Ensure the holes of the second mounting crossbar (A2) line up with the drilled and anchored holes.
4. Once position is set, mount second crossbar (A2) to wall using the MS2 screws provided, as seen in Figure 1. This will be the bottom crossbar of your wall mount.

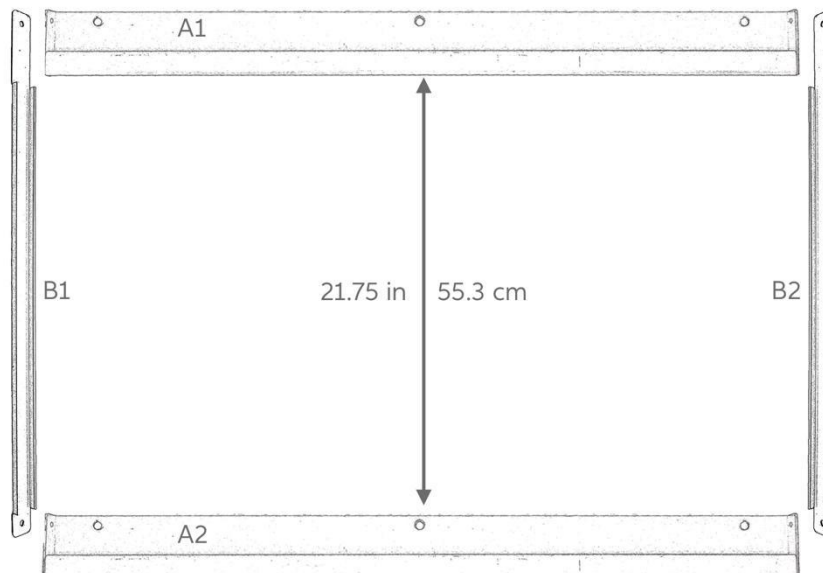

Fig. 2

(Spreader bars – B1 & B2 – are not weight-bearing, and are intended for alignment purposes only)

Step 3:

1. Once both top and bottom mounting crossbars (A1 & A2) are secured to your wall, set your first spreader bar (B1) onto crossbars (A1 & A2). Assuming the crossbars (white) were installed with the appropriate distance between them, the spreader bar (B1) should set cleanly in place.
2. Secure first spreader bar (B1) onto crossbars (A1 & A2) with pan screws (PS) provided, as seen in Figure 3.
3. Repeat this process for your second spreader bar (B2).

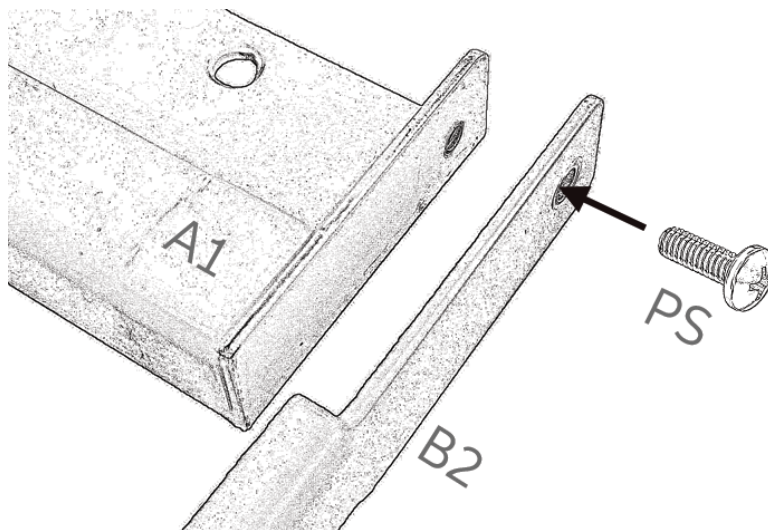

Fig. 3
(Image shows top of B2 and right side of A1)

Step 4:

1. Attach rope handles (RH) to sides of RHINO using the flat top screws (FS) provided, as seen in Figure 4.

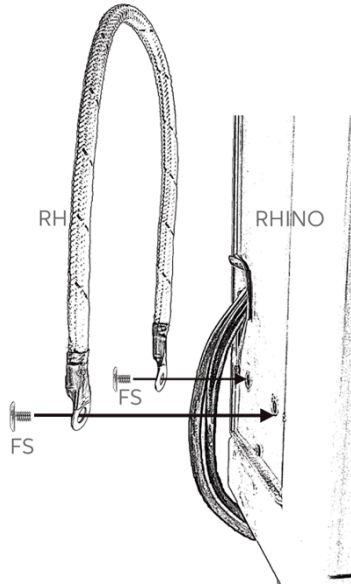

Fig. 4

Step 5:

1. Using rope handles (RH) and supporting the front of the unit with your hand, set RHINO onto mounting crossbars (A1 & A2), as seen in Figure 5. If crossbars are spaced appropriately and level, RHINO should set cleanly onto the crossbars (A1 & A2).

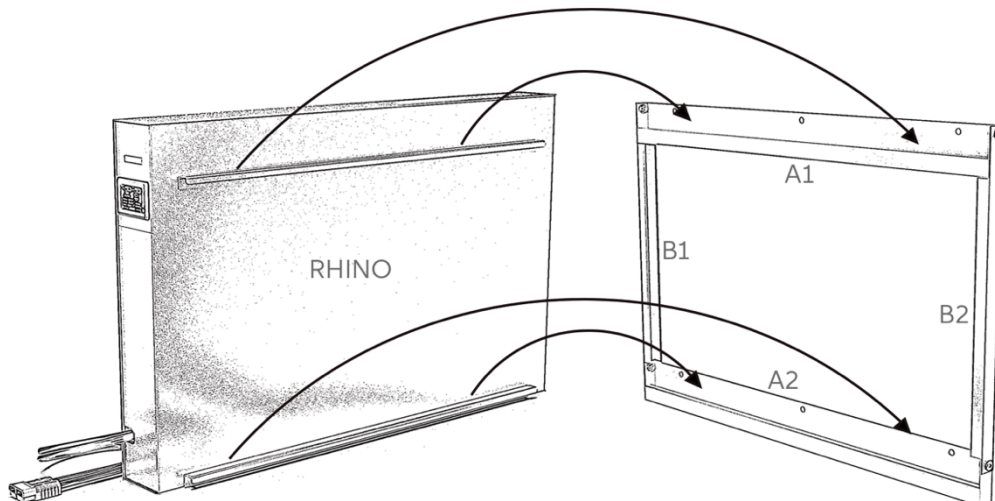

Fig. 5

(NOTE: For safety, use at least 3 people when lifting and setting RHINO onto wall mount. 4+ people is recommended for maximum safety.)

Step 6:

1. Connect the Ring Terminals of your Anderson SB175 to Ring Terminal Cable (SB) to your power system.
2. With the RHINO now mounted on your wall, remove side panel of RHINO.
3. Connect Anderson SB175 end of Anderson SB175 to Ring Terminal Cable (SB) to Anderson SB175 cable inside of the RHINO, as seen in Figure 6.
4. Reattach side panel of RHINO.

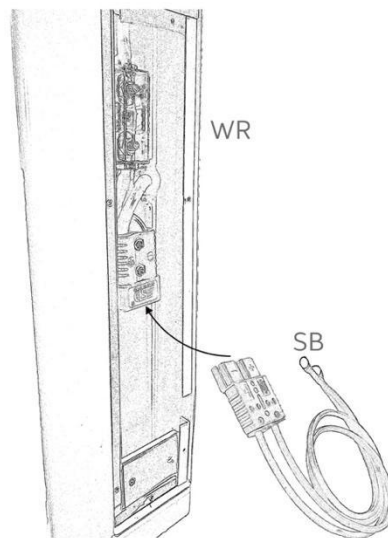

Fig. 6

5.3 Floor Stand

⚠ WARNING: Before installing your RHINOs onto the floor stand (FLS), make sure the wheels are facing outward with the locking mechanism engaged. If wheels are rotated inward, regardless of whether locking mechanism is engaged, there is a greater risk of the floor stand (FLS) tipping over which could result in injury.

Step 1:

1. Attach rope handles (RH) to sides of the first RHINO unit using the flat top screws (FS) provided, as seen in Figure 4.

Step 2:

1. Set first RHINO onto one side of floor stand. The RHINO should set cleanly into the cutout section of the white mounting bar on the inside the floor stand (FLS), as seen in Figure 7.

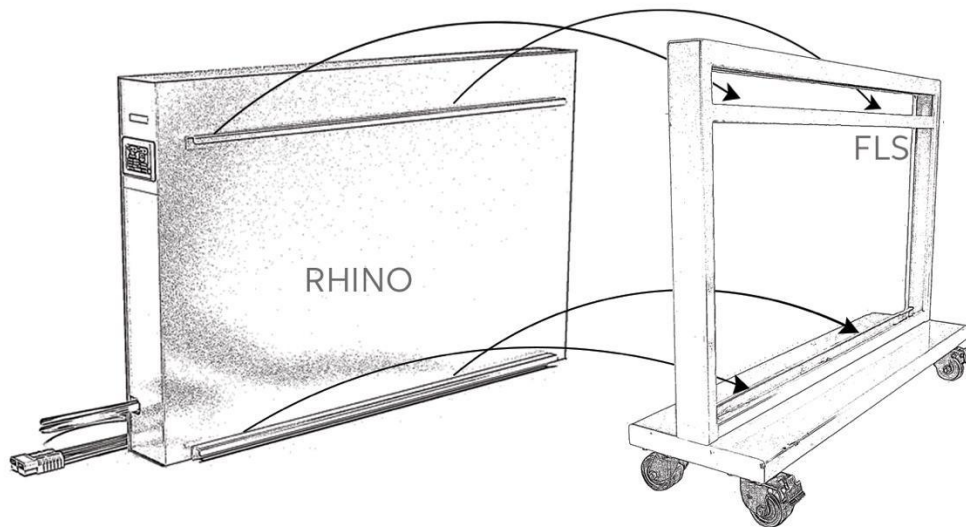

Fig. 7

(NOTE: For safety, use at least 2 people when lifting and setting RHINO onto floor stand (FLS). 3+ people is recommended for maximum safety.)

Step 3:

1. Connect the Ring Terminals of your Anderson SB175 to Ring Terminal Cable (SB) to your power system.
2. Remove side panel of RHINO.
3. Connect Anderson SB175 end of Anderson SB175 to Ring Terminal Cable (SB) to Anderson SB175 cable inside of the RHINO, as seen in Figure 6.
4. Reattach side panel of RHINO.

Step 4:

1. Repeat Steps 1 – 3 with your second RHINO. When finished, your RHINOs and floor stand should resemble Figure 8.

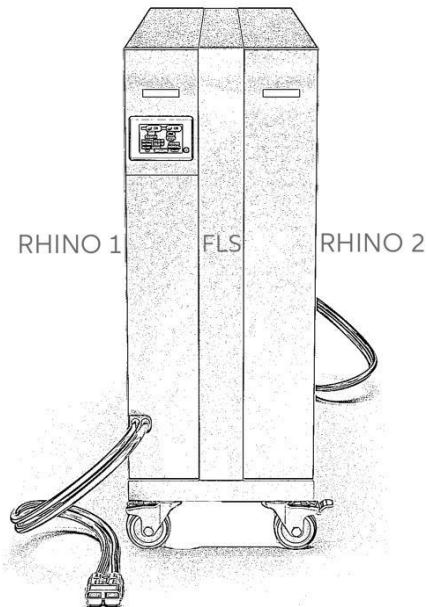

Fig. 8

Step 5:

1. Once both RHINOs are set into place, set crossbar plates (CP) onto corresponding screw holes on the top of the floor stand
2. Secure to floor stand with the flat top screws (FS) provided, as seen in Figure 9.
3. Once crossbars are secured, you may unlock wheels and move your RHINOs freely.

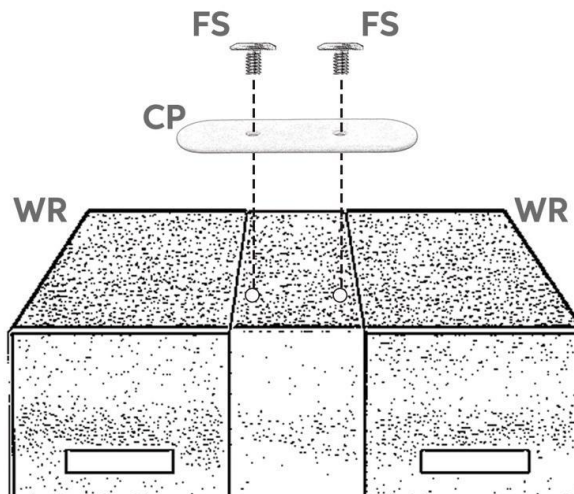
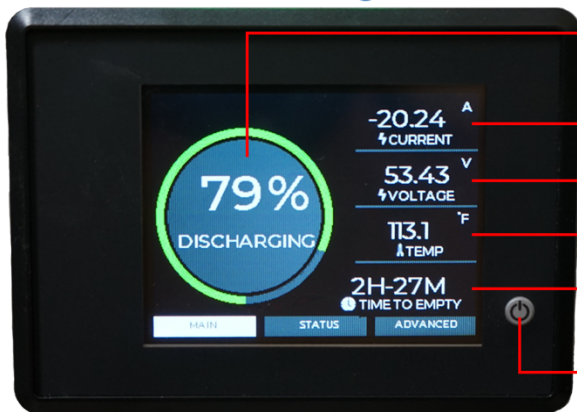

Fig. 9

6. Battery Interface

6.1 Overview

Main Page



- Energy percentage
- Charging/Discharging amperage (+ when charging, - when discharging)
- Voltage
- Temperature (F°)
- Est. time until empty
- Display wake-up button

Status Page



- Total Ah charged/discharged this cycle
- On/Off button (discharging)
- On/Off button (charging)
- Cycle count
- Max./Min. temp. (F°) since turning on
- Battery status (see code descriptions below)

Advanced Page

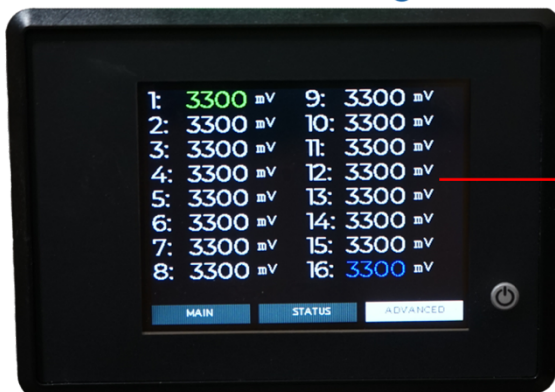

- Voltage for each cell

6.2 BMS Codes

Symbol	Category	Description
COV	Voltage Protection	Over voltage protection by battery cell level
CUV	Voltage Protection	Under voltage protection by battery cell level
POVP	Voltage Protection	Whole pack over voltage protection
PUVP	Voltage Protection	Whole pack under voltage protection
COCP	Temperature Protection	Over temperature protection while charging
CUTP	Temperature Protection	Under temperature protection while charging
DOCP	Temperature Protection	Over temperature protection while discharging
DUTP	Temperature Protection	Under temperature protection while discharging
COTP	Current Protection	Overcurrent protection while charging
SC	Short Circuit	Short circuit protection
LOCK	Status	Lock status
NOMAL	Status	Normal status

7. Recycling

Dispose of LiFePO4 batteries at an authorized lithium recycling facility, or please return to BigBattery. We can take care of your batteries for recycling for you.

8. Warranty & Returns

In the unlikely event you are having an issue with one of our batteries we have developed a straightforward warranty & return policy which includes the following:

- For all returns or warranty claims contact support@bigbattery.com.
- 30-day money back guarantee. Returns of undamaged batteries unrelated to warranty claims may be issued full refunds less a 20% restocking fee.
- We have a 10-year warranty on all new batteries. For more information, visit the Policies page at BigBattery.com.
- We offer a 30-day warranty on all cells, accessories & complimentary products (Anderson connectors, wires, chargers, etc.).
- Warranty only applies to original owner (non-transferable).
- Warranties can be used for an exchange of a component only once per component.
- Operating the battery outside of acceptable parameters, according to our listed battery specs (ref. Section 3.1) will void your warranty.
 - Example: Using an incorrect charger may exceed max. charging voltage specifications.
 - WARNING: Make sure to use the appropriate charger for your battery.
- Customer pays return shipping on returns or warrantied component inspections initiated after the first 30 days of ownership. Please note some battery returns may require special documentation and packaging, and these instances will encounter extra fees. This is to correctly comply with lithium battery shipping regulations.
- If you have a quality issue with a product, please contact our support team to help properly diagnose the problem. If the product you receive does not meet our rigorous quality standards, then we will issue you a replacement component or fix the original at no additional cost. Replacement batteries or components will only be sent after we have received your returned battery or component and finished an inspection to determine the cause of any problems. BigBattery is not responsible for return shipping.
- DIY modifications or damage due to gross negligence or abuse are not covered by the warranty.

For all returns, please mail your package in a traceable method to the address below. Include a note with your name, your order number and describing your situation and/or request.

BigBattery Inc.
Technical Support Team
support@bigbattery.com
(818) 280-3091, ext. 1005
9667 Owensmouth Ave., Suite 105
Chatsworth, California 91311