

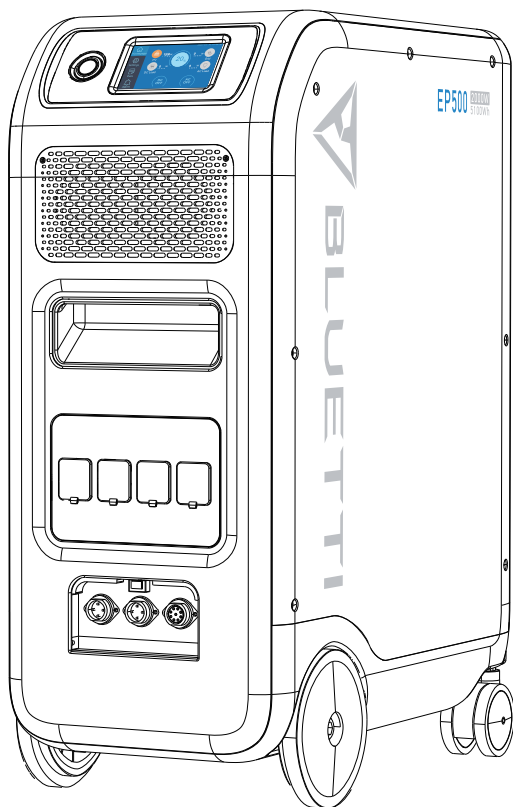

BLUETTI

EP500 POWER STATION

Please read this manual before use and follow its guidance. Keep this manual for future reference.



User Manual

Please read this manual before use and follow its guidance. Keep this manual for future reference.

Contents

01. EP500 Introduction	01
02. General Safety Instructions	02
03. What`s in the Box	06
04. APP User Guide	07
05. Features of EP500	11
06. Start up & Power off	12
07. User Interface	13
08. How to Recharge EP500 (INPUT)	20
09. Discharge (OUTPUT)	24
10. UPS	27
11. Split Phase Function	31
12. Technical Specification	32
13. Storage and Maintenance	34
14. Troubleshooting	35
15. FAQ (Frequently Asked Questions)	38
16. Declaration	39

01. EP500 Introduction

1.1. Introduction

- BLUETTI is proud to take the energy storage world by storm with the release of its first home energy storage system series - the EP500 with four smooth-rolling transport wheels, the EP500 was not designed to be a large solar battery mounted on the wall or in the garage. The BLUETTI EP500 was not only designed to be a "No Installation Needed", plug-and-play mobile UPS that can easily be moved to a desired location when necessary, but also a power backup system that ensure emergency power when power outage occurs.
- The EP500 system uses a dual-core controller (ARM controller + DSP controller) which combines digital and analog signals perfectly to manage and control the AC Charger module, the MPPT module, the AC Inverter module, the DC-to-DC module, and the battery module.
- This product integrates a solar charge controller, AC charge controller, AC inverter, lithium battery and battery management system into one. It converts clean and environmentally friendly solar energy and grid electricity into clean electricity and sends it to all of your connected loads in your home.
- EP500 Power Station system is suitable for areas with energy shortage or unstable power, and also for power supply or disaster emergency in areas without electricity such as isolated islands and border posts.

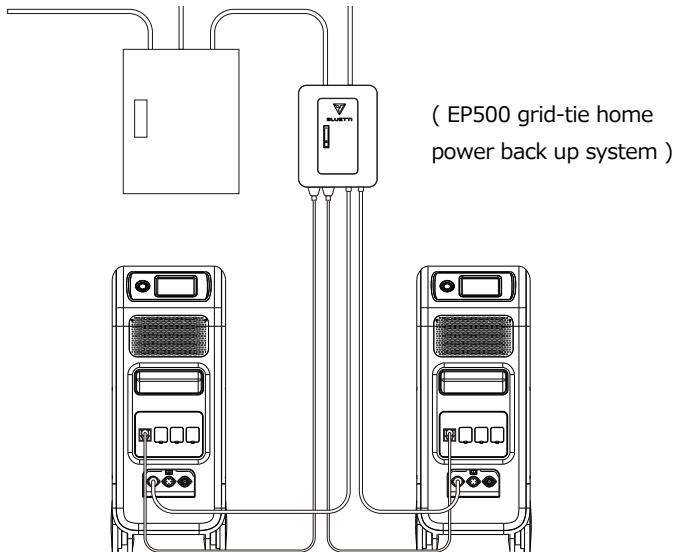

1.2. Abbreviation

- BMS: Battery management system
- MPPT: Max. power point tracking
- UPS: Uninterruptible power supply
- AC: Alternating current
- DC: Direct current
- PV: Solar panels charging
- Grid: Home electricity circuit
- T500: 500W additional adaptor
- DOD: Depth of discharge
- ECO Mode: Power saving function for power station, turn off the AC output port automatically if the power of AC output of the load is less than 20W in 4 hours.

02. General Safety Instructions

Please read this manual before operating.

- A licensed electrician is required to install the grid-tie power system as involves connecting the wires of critical equipment from your main electrical box to the BLUETTI Sub Panel (Optional Purchase).
- DO NOT place the power station near heat sources. It is prohibited to place the equipment in an environment with flammable, explosive gas, or smoke. It is also prohibited to operate the equipment in this environment.
- DO NOT attempt to replace the internal battery or any other component of the equipment by anyone other than authorized personnel. There are no user serviceable components.
- DO NOT operate in wet conditions. If the equipment becomes wet, please let the unit dry completely before using.
- Please ensure proper ventilation while in use and do not obstruct fan openings. Inadequate ventilation may cause permanent damage to the equipment.
- DO NOT stack anything on top of the power station either in storage or while in use. DO NOT move the unit while operating as vibrations and impacts may lead to poor connectivity to hardware inside.

- Warning: DO NOT insert foreign objects into any ports of EP500 (both AC & DC & ventilation holes). The power station generates the same potentially lethal AC power as household wall outlet. Please use carefully and keep children away from it.
- If necessary, only dry powder fire extinguisher is suitable for the product.
- For safety purposes, please use only the original charger and cables designed for the equipment. We are not liable for damage caused by third-party equipment and may render your warranty, invalid.

2.1. Installation (for grid-tie system)

- Before touching any conductor surface or terminal, measure the voltage of the contact point to confirm that there is no danger of electric shock.
- After the equipment is installed, empty packaging materials such as cartons, foam, plastic, cable ties, etc. should be removed from the equipment area.
- Except those who operate the equipment, please keep others away from the equipment.
- The handling of any tools being used needs to be insulated and protected from shock, or use insulated tools.
- All wiring holes need to be sealed. Use fire-resistant mud to seal the wiring holes that have been routed and use the cover of the cabinet.
- It is strictly forbidden to alter, damage or obscure the logo and nameplate on the equipment.
- When installing the device, please use the appropriate tools to tighten any screws.
- Live operation is strictly prohibited during installation.
- Paint scratches during equipment transportation and installation must be repaired in a timely manner. Long-term scratches are strictly prohibited and may cause damage.
- Before operation, the equipment should be secured onto a floor or other stable objects, such as walls or possibly mounting brackets if needed.
- It is prohibited to clean any electrical components inside and outside the cabinet with water.
- Do not change or modify the structure, installation sequence, etc. of the equipment without prior authorization.

2.1.1. Personal Safety

- During the operation of the equipment, if a malfunction that may cause personal injury or equipment damage is found, it should be terminated immediately.
- Please do not power on the device if the device has not been installed or confirmed by relevant experts.

2.1.2. Personnel Requirements

- The personnel responsible for the installation and maintenance of the equipment must first undergo rigorous training to understand various safety precautions and grasp the correct method of operation.
- Trained personnel: personnel who have undergone corresponding technical training and have the necessary experience to be aware of the danger that may be brought to him during the operation, and can take measures to reduce the danger to himself or other personnel to at the lowest limit.
- The replacement of equipment or parts (including software) must be done by professionals or authorized personnel.

2.1.3. Anti-static requirements

When installing the sub-panel with your main panel, you must wear anti-static gloves or an anti-static wrist strap before touching the device. The other end of the anti-static wrist strap should be properly grounded. Do not touch any bare components directly with your hands.

2.1.4. Drilling

The following safety precautions are to be considered when drilling holes on the wall or into the ground:

- It is strictly forbidden to drill holes into the equipment. Drilling will alter and damage the electromagnetic shielding performance of the equipment, internal components, and cables. The risk of metal shavings entering the device can cause short circuits on the circuit board.
- Wear goggles and protective gloves when drilling holes.
- The equipment should be shielded and protected during the drilling process to prevent debris from falling into the equipment. After drilling, any and all debris which may have landed on the equipment should be removed and cleaned in a timely manner.

2.2. Installation environment requirements

- When the equipment is running, please do not block the vents or the heat dissipation system in order to prevent high temperatures and/or fires.
- The equipment should be installed in an area away from liquids. It is forbidden to install it near or below water pipes, air outlets and other locations that are prone to water condensation.
- It is forbidden to install below air-conditioning vents, vents, outlet windows in the computer room and other places that are prone to water leaks in order to prevent liquids from entering into the equipment. Equipment failure or a short circuit could occur.
- If liquid is found inside the device, please turn off the power immediately and notify the administrator.
- The equipment room must have good heat insulation, and the walls and floors must be damp-proof. Add a rat-proof baffle at the door of the machine room.

03. What`s in the Box

Standard Accessories

No.	Category	Quantity
1	EP500 Power Station	1
2	AC Charging Cable	1
3	PV Charging Cable	1
4	User Manual	1
5	Warranty Card	1
6	Certificate of QC PASS	1

Additional Purchase Accessories

Sold on BLUETTIPOWER.COM

No.	Category
1	Split Phase Fusion Box
2	Output Cable for Split Phase Fusion Box
3	Communication Cable for Split Phase Fusion Box
4	12V/30A RV Cable
5	Generator Charging Cable
6	Sub Panel
7	PV Step Down Module
8	Additional T500 Adapter

04. APP User Guide

Please make sure the Bluetooth & Wi-Fi State is “ON” before connecting EP500 with BLUETTI App.

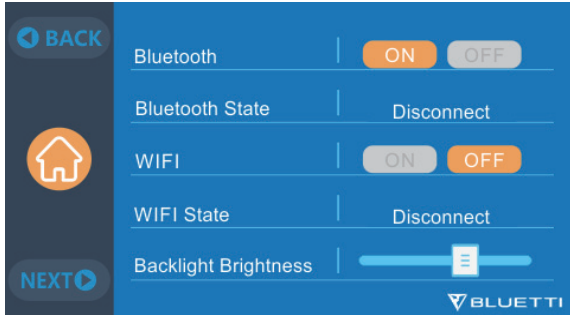

(Main Interface - Settings - Next - Next - Next)

Step 1:

- Please search “BLUETTI” on the App Store (for IOS devices) or Google Play (for Android devices) to download the BLUETTI App to remotely control your EP500. EP500 can be controlled via Bluetooth or Wi-Fi. To activate the remote control, please launch the BLUETTI App, and tap the “LOGIN” icon to register your BLUETTI account.

Fill with your related information to continue.

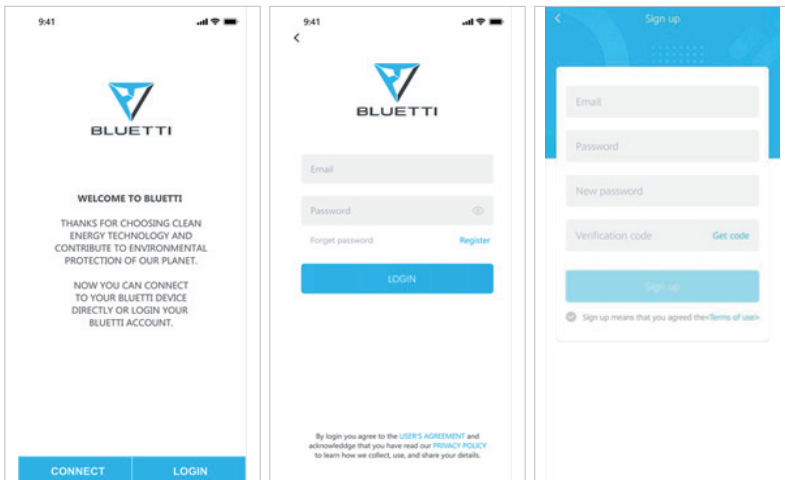

- Check your email account you used in the BLUETTI App for the verification code sent from BLUETTI and fill in the activation code located within the email to activate your BLUETTI account.

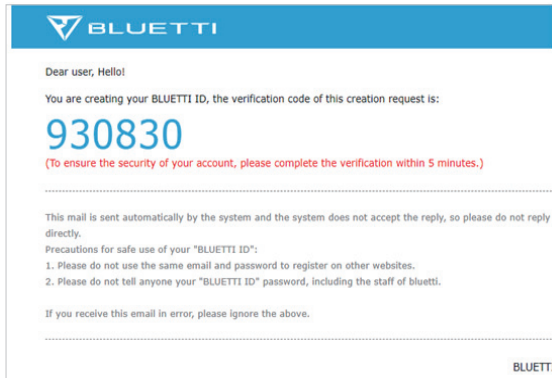

Step 2 :

- Scan the unique QR code on EP500 to add the unit on the available device list on the App, and fill it with the password of your **2.4G** Wi-Fi network to activate the communication function of EP500 for data syncing.

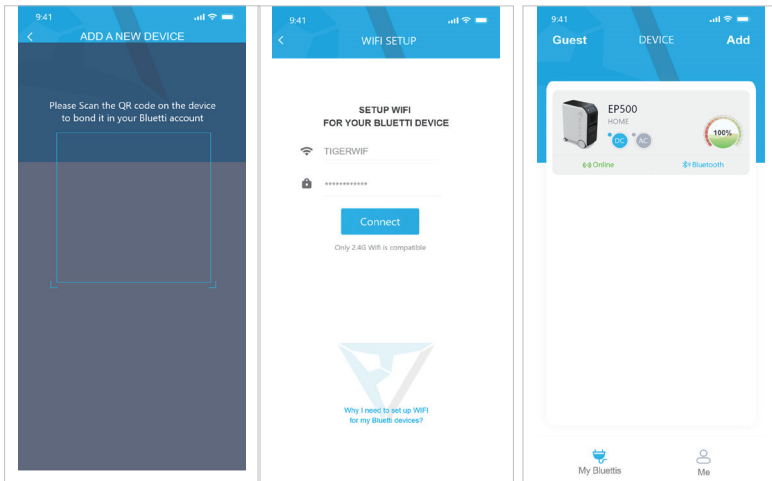

- For Bluetooth Connecting, click “CONNECT” at the homepage to connect EP500 with your phone via Bluetooth, select the SN number of your devices. Please press “settings-product info” on EP500 to view the SN number of your unit.

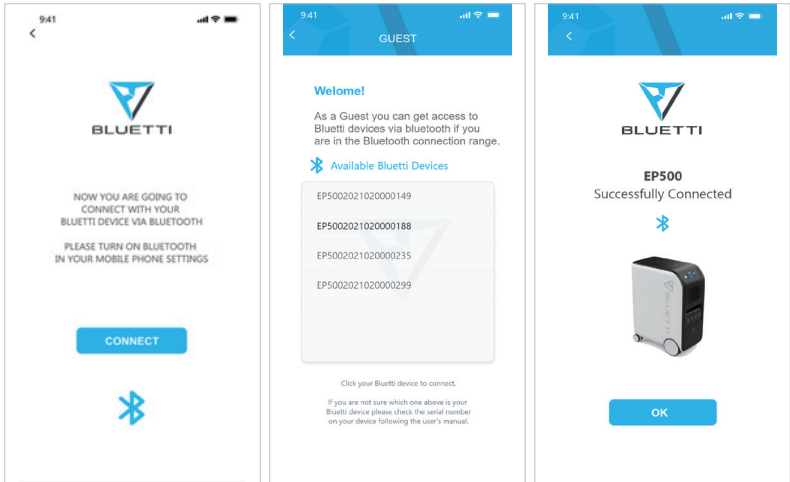

- The basic information can be viewed after the unit is connected with App successfully. Press “gear icon” to customize the current working mode and parameters of your EP500 under “Settings”.

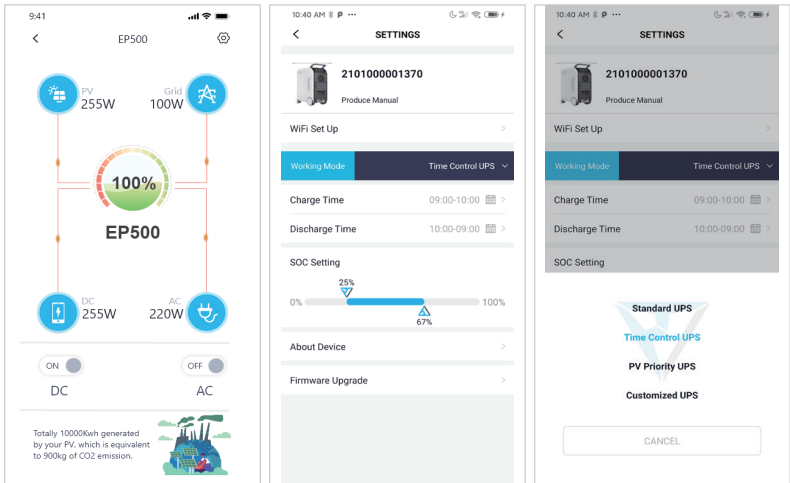

- BLUETTI App supports “Firmware Update” function to access the latest version of firmware for a better user experience.

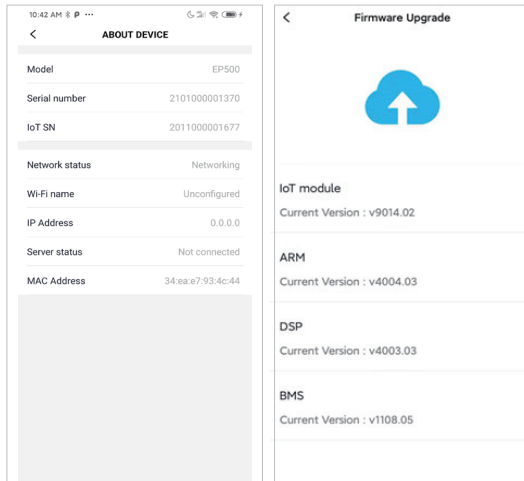

NOTE: Please keep your phone 5m/16.4ft within the EP500 for better connection during update.
Please follow the instruction listed below if the IOS version BLUETTI APP failed to connect to internet. By tapping Settings - scroll down until BLUETTI icon shows up - Enable the Wireless and Data.

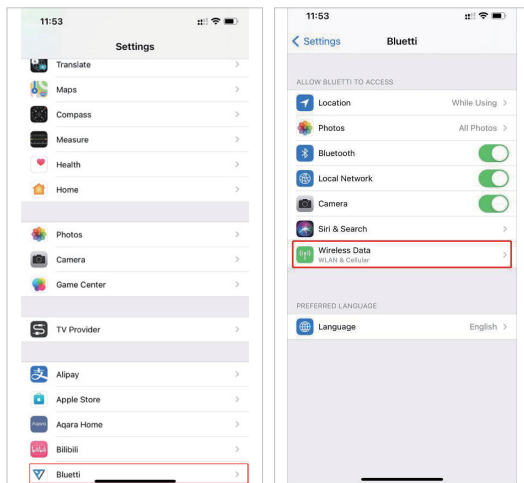

05. Features of EP500

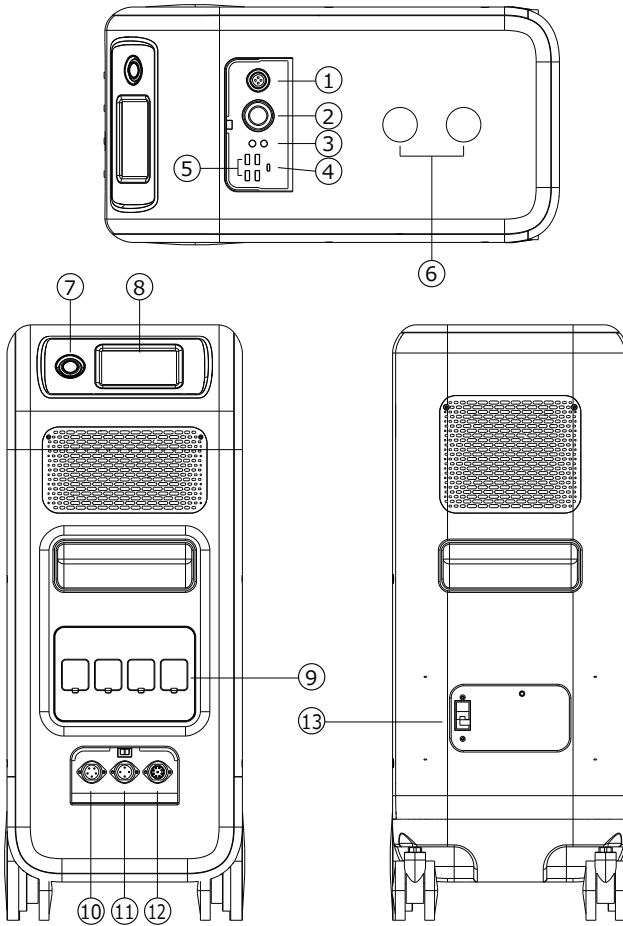

- 01 12V/30A Port
- 02 12V/10A Cigarette Lighter Port
- 03 12V/10A DC5521 Port
- 04 USB-C (PD3.0 protocol supported)
- 05 USB-A
- 06 Wireless Charging Pad (Qi protocol supported)
- 07 Power Button
- 08 Touchable Screen
- 09 AC Output Port
- 10 AC Input Port
- 11 PV/T500 Input Port
- 12 Communication Interface
- 13 Main Battery Switch

06. Start up & Power off

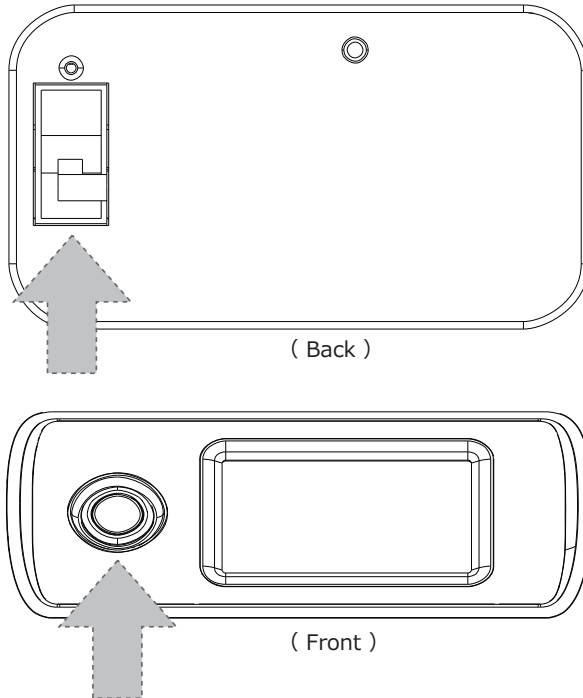

- Turn on the main power switch on the back of EP500.
- Power On: Short press the power button. The power button indicator will illuminate.
- Power Off: Long press the power button for 2 seconds. The power button indicator light will turn off.
- DC power switch and AC power switch are accessible via the Touchscreen LCD. Press the "DC ON/OFF" button and/or "AC ON/OFF" button on the screen to turn ON/OFF the DC/AC output.
- EP500 will turn on automatically from Power Off status when either grid charging and/or PV charging is applied to the unit.

07. User Interface

7.1. Home Page

Tip: The LCD display is a resistive touchscreen. It is recommended when operating the touchscreen that you press lightly with the edge off your fingernail until it "beeps" when it registers a press. (**NOTE: Touchscreen sounds can be disabled in the Settings menu**).

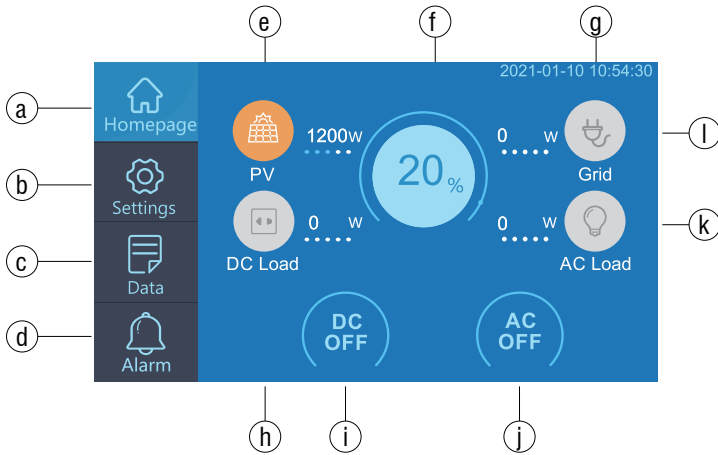

- a. Homepage
- b. Settings
- c. Data
- d. Alarm
- e. PV Charging Information
- f. BMS Information
- g. Date/Time
- h. DC load Information
- i . DC ON/OFF
- j . AC ON/OFF
- k. AC load Information
- l . AC Charging Information

7.2. Settings

- You can customize the working mode of EP500 and tweak the equipment's parameters such as language, voltage, frequency, current (UPS In-Grid Mode), working type, date/time, etc.
- Click the Settings Button in the homepage to enter the setting interface.

7.2.1. AC Output Voltage & Frequency

- Here are the list of standard output voltage and frequency in 5 regions or countries. You may click on the screen to set the parameters as needed.
- **NOTE: Please check the output voltage, frequency, and date/time BEFORE using for the first time. The EP500 100-120V AC version cannot be set to 220-240V AC output and vice-versa.**
- **Output frequency and voltage can only be tweaked when the AC is OFF (tap the AC icon at main interface to turn off AC output if it`s ON).**
- DC Input Source: PV for normal solar charging, OTHERS for D300S charging.
 - JP Output: 100V/50Hz
 - AU Output: 240V/50Hz
 - US Output: 120V/60Hz
 - EU/UK Output: 230V/50Hz

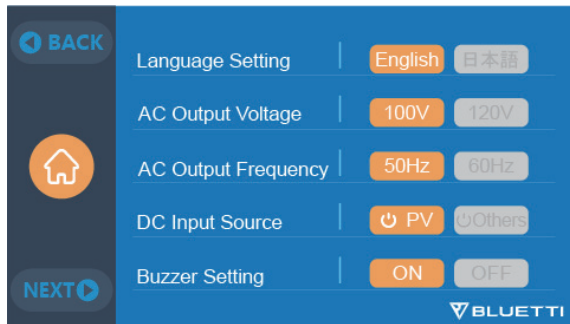

7.2.1. Language Setting & ECO Mode

Tap "English" or "Japanese" icon to set as the system language display of your EP500.

ECO: Turn off the AC output port if the load on AC is less than 20W over 4 hours.

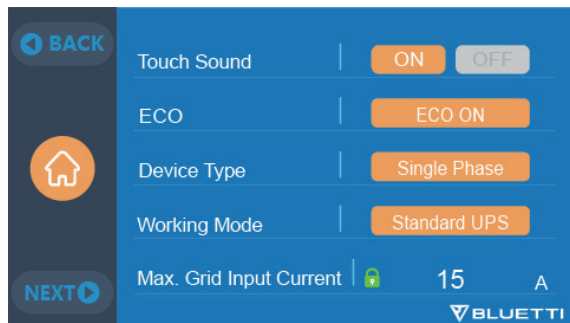

7.2.3. Machine Type (for split phase setting, exclusive for 100-120V Version)

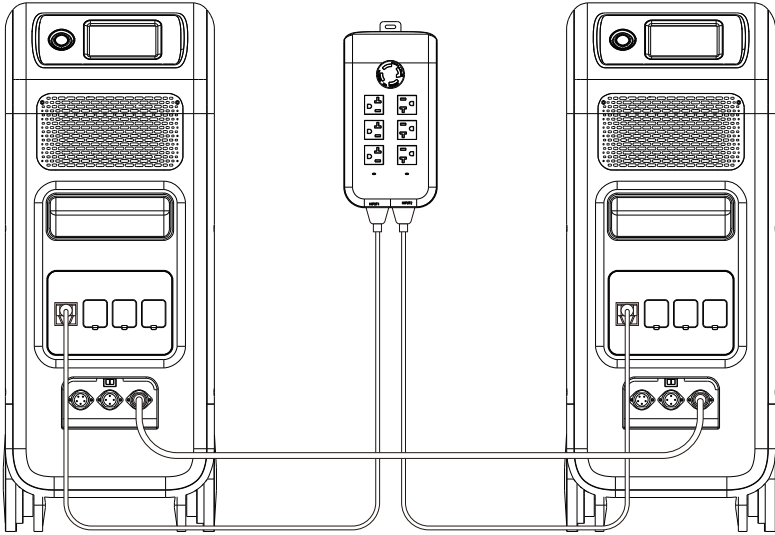

“Single Phase” is set as the default machine type if you are operating a single EP500. This is the only and correct setting if a single EP500 is being used. Machine type is just used to set for Split Phase, “Split Phase” is only used for connecting both *2 EP500 (exclusive for 100-120V Version) bonded 2 pairs of EP500 to one power system to double the output power, voltage, so as to capacity.

Please refer to Split Phase setting for detailed information.

7.2.4. Working Mode

Tips: EP500 will be set as the Standard UPS Mode.

There are altogether four working modes you can select in settings:

Standard UPS Mode: Default working mode(including Online and Offline mode).

PV Priority Mode: Recommended for areas in stable power supply.

Time Control Mode: Suitable for areas with peak and off-peak time-of-use rates for money saving.

Customized Mode: Customized the parameters for a better user experience.

Detailed UPS Mode setting please check the chapter **10. UPS**.

7.2.5. Max. Grid Input Current

- Please check the specification of your grid, sockets, connections, wires, etc. to determine the maximum allowable current that can be drawn by the EP500. BLUETTI is not liable for any damages, injuries, or any other legal responsibility incurred directly or indirectly from changes made to this setting.
- Max. Grid Input Current: limit the Max. current of the tied grid, when the current exceeds the preset value, EP500 will take in charge to be the power source of the circuit.

**Note: Only take effective when EP500 has been connected into grid.
The default Max. Grid Input Current: 15A.**

- Safety Password of Max. Current: *159873*

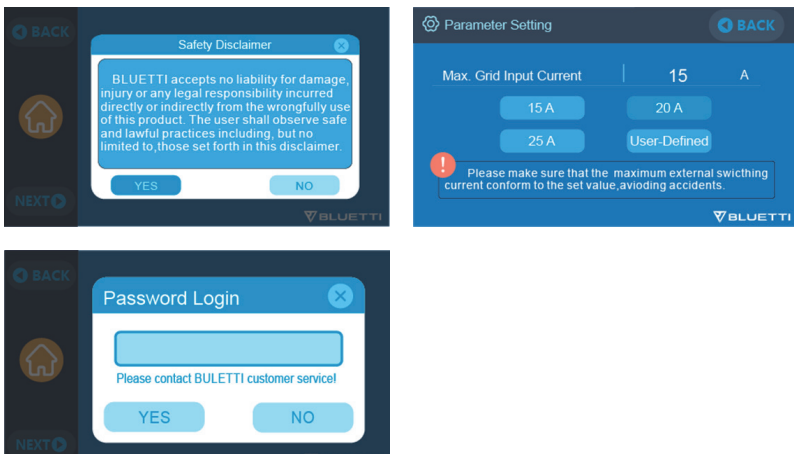

7.2.6. Date and time & Touch Sound & Backlight Brightness

- Tap each respective date and time setting in order to set the date and time as applicable to your local time zone.
- Tap to Enable/Disable touch sounds.
- You may change the Backlight Brightness of the Touchscreen LCD by using the slider on the screen.



7.2.7. Bluetooth & Wi-Fi Connection

The Bluetooth and Wi-Fi connection can be turned ON or OFF by tapping the ON and OFF icon for either function.

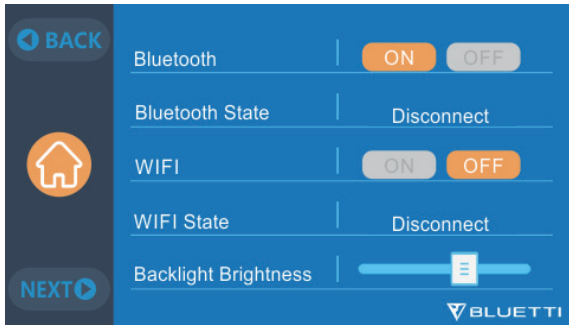

7.3. Data

In the Data section, you may view Product Info, Inverter & Charger Info, BMS Maintenance, and Alarm/Fault History by selecting each respective button.

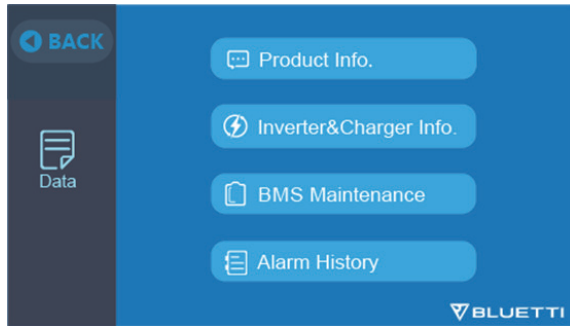

7.3.1. Product Info

- When you select the “Product Info” button, you can view the product model, serial number (SN), control software version, monitoring software version, BMS monitoring software version and display software version.
- The Serial Number (SN) can also be used to pair to BLUETTI APP manually.



7.3.2. Inverter & Charger Info

When you select the “Inverter & Charger Info” button, you can view the PV charging and the adapter charging status, DC output and AC output information as well. The section can also be accessed directly from the shortcut icon on the main interface.

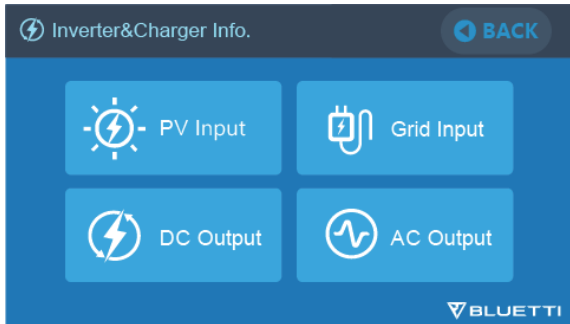

7.3.3. BMS Maintenance

When you select the “BMS Maintenance” button, you can view the information of the BMS. This section can also be accessed directly from the shortcut icon on the main interface.



7.3.4. Alarm History

Click the “Alarm History” button, you can view all the alarm information generated by the machine. You can turn to the troubleshooting page to check the corresponding solutions.

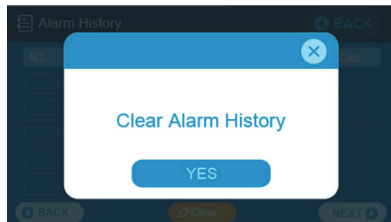
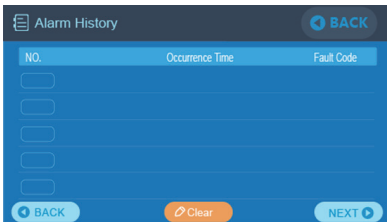

08. How to Recharge EP500 (INPUT)

- The EP500 includes 2 charging ports which can be recharged in 5 different methods. They will be covered in three different sections according to which port(s) are being used.
- The ports are named Aviation Port 1 [CP1] (left) and Aviation Port 2 [CP2] (middle) below the AC output ports.

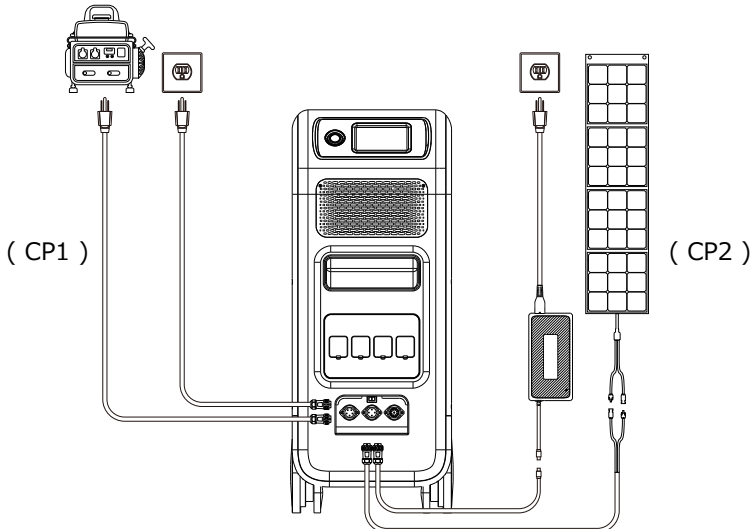

8.1. CP1 (1st Charging Port)

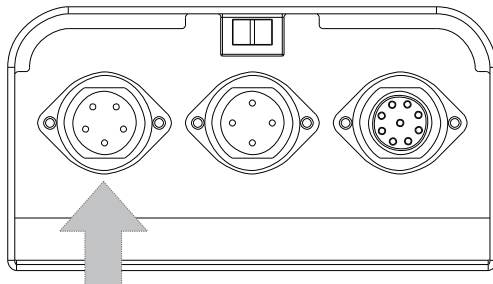

8.1.1. Charging Method 1: From Wall Outlet (by AC charging cable)

Connect EP500 from CP1 via AC charging cable to the AC wall outlet @600W Max., the charging process will automatically stop when it reaches 100% capacity.

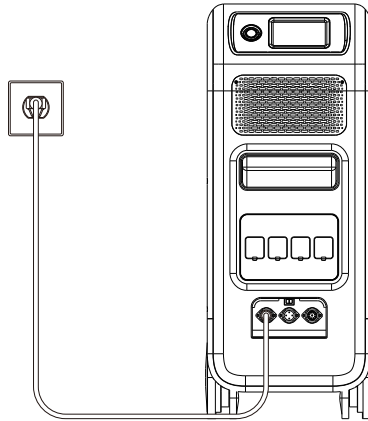

8.1.2. Charging Method 2: From Generator (gasoline, propane, or diesel)

- Connect the EP500 from CP1 via the generator charging cable (sold separately) to the AC output of the generator. The charging process will automatically stop when it reaches 100%.
- The required output power of your generator has to exceed the Max. input power of the AC input port of the EP500. Also a generator with a pure sine wave output is recommended (e.g. Inverted-based Generators)
Voltage limit: 90V-264V Frequency limit: 47Hz-63Hz

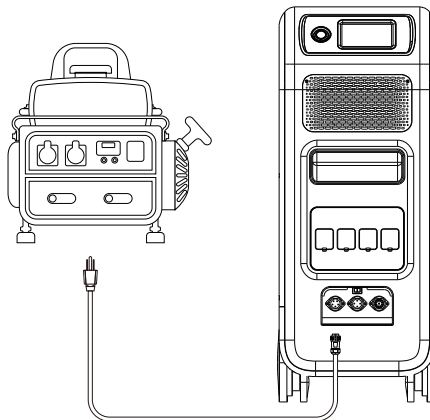

8.2. CP2 (2nd Charging Port)

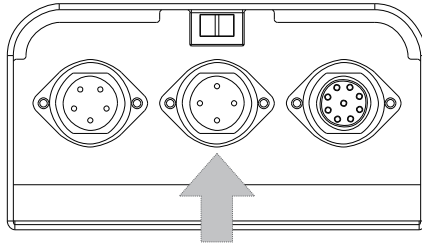

8.2.1. Charging Method 3: Solar Panels (via 4pin aviation-MC4 cable)

● For regular solar panels:

Max. input current of solar charging is 20A, the charging voltage should be between 55-145V. EP500 can achieve Max. 1200W solar input.

- User can connect 4-6 pieces of sp200 solar panels in series (figure 1).
- Connect the MC4 port of solar panels to the MC4-Aviation cable (figure 2/3).
- Plug the Aviation cable to the middle input port on EP500.

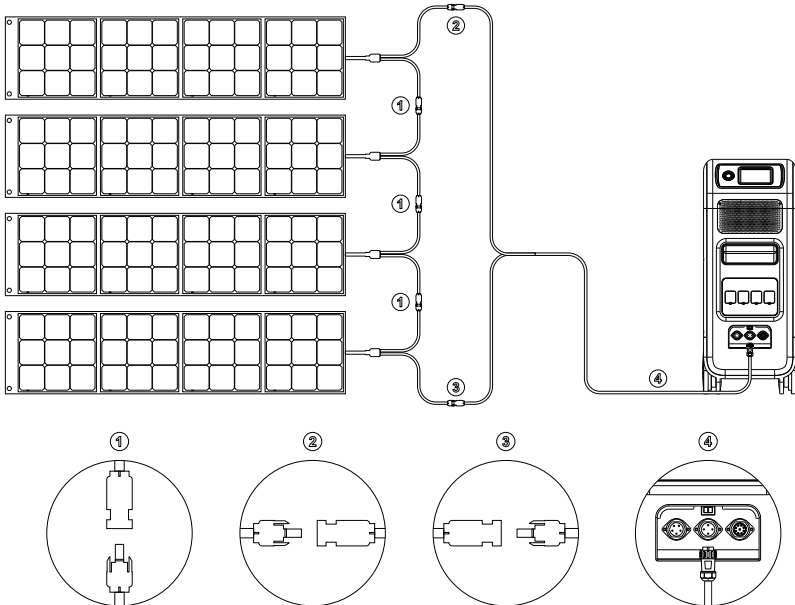

(Easy steps to solar charging)

● For Roof Panels:

If you choose roof panels to be the solar power source to recharge EP500, easily connect your roof panel with MC4-Aviation to EP500 will finish the installation. PV Module (additional accessories) is required to drop down the voltage if the open circuit voltage produced by your roof panels exceeds the limit of EP500 can handle: 55-145VDC, 20A.

This PV module doesn't work with solar panels that have built-in microinverters, or open circuit voltage over 550V.

Please check BLUETTI Youtube channel: BLUETTI Official for detailed instruction video.

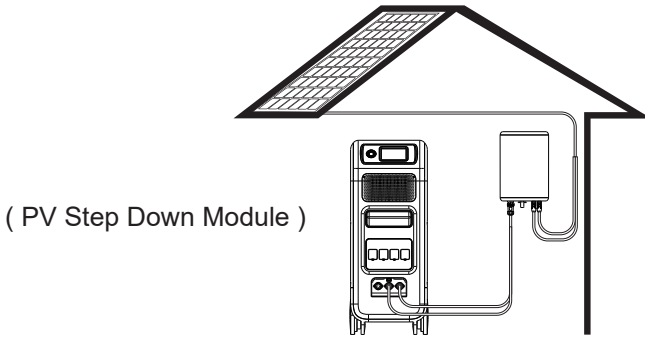

8.3. Dual Charging

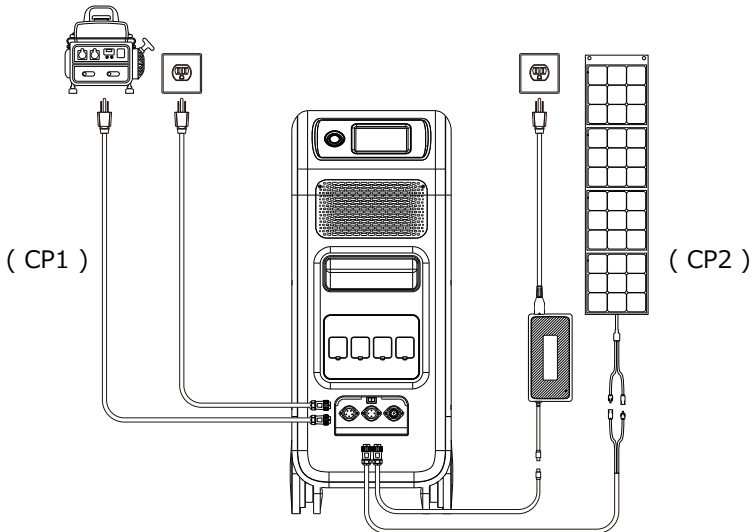

Charging Method 5: Supports charging the EP500 with CP1 and CP2 at same time. You can use any charging methods listed previously, simultaneous, to maximize charging power input. They are listed here again for your convenience. Select one method for CP1 and one method for CP2 for simultaneous charging.

CP1 Charging Port Select:

Method 1: GEN charging cable

Method 2: AC charging cable

CP2 Charging Port Select:

Method 3: T500 charging adaptor

Method 4: Solar panels

8.4. How to calculate the recharging time of EP500

$5120\text{Wh} / \text{Total recharging power} + 0.5\text{-}1\text{Hrs}$ (trickle charging time) = fully charging time estimation

E.g. : The total recharging power is 1100W(500W+600W) recharged by AC and 2nd adaptor at same time, the estimation charging time will be 5.13-5.63Hrs.

09. Discharge (OUTPUT)

The operational time of the EP500 is subject to many different factors such ambient temperature, discharge rate, remaining battery capacity, and other factors.

9.1. The Output Port

9.1.1. AC Output Port

- EP500 is equipped with *4 AC(US, JP version) / *3 AC(AU,EU,UK) outputs with a continuous 2000W Max. power of output in total, and the ability to support surges up to 4,800W.

● Please make sure the combined power requirements of your appliances does not exceed the 2,000W limit.

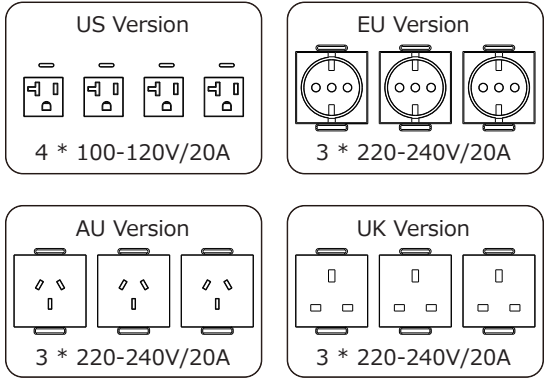

9.1.1. DC Output Port

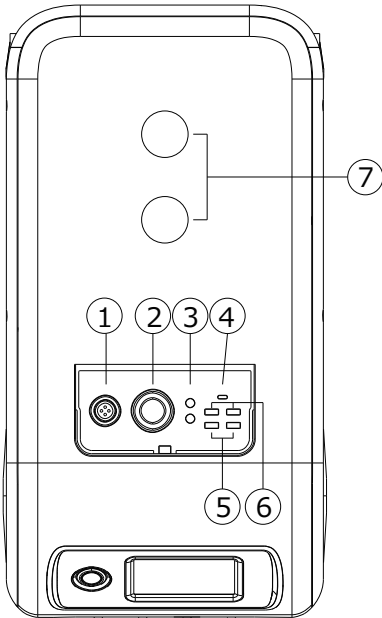

- 1. *1 RV port
- 2. *1 Cigarette lighter port
- 3. *2 DC 5521
- 4. *1 USB-C
- 5. *2 USB-A (fast charging)
- 6. *2 USB-A
- 7. *2 Wireless charging pad

9.2. Operation Time Estimation

● Kitchen Equipment



Refrigerator
150W(1200W)
4-5 Hrs



Electric Fry Pan
1500W
2.8 Hrs



Microwave Oven
1000W
4.1 Hrs



Washer
500W(1000W)
8.2 Hrs

● Home Equipment



Space Heater
1500W
2.8 Hrs



Air Conditioning
8000Btu
6.3-17.3 Hrs



Smart Phone
15Wh
280+ Times



Laptop
49Wh
80+ Times



Desktop
300W
14 Hrs



CPAP
40W
58.5 Hrs

● Tools



Bench Grinder
1400W
2.5 Hrs



Welding Machine
1800W
2.3 Hrs



Circular Saw
1400W(2300W)
2.5 Hrs

● Transportation



Electric Vehicle(16A)
1800W
10-16 Miles



E-Bike
500W
100-150 Miles

(The estimation operating time is only for reference)

9.3. How to Calculate the Operation Time

- $5120\text{Wh} * \text{DOD} * \eta / (\text{load } W) = \text{operation time (unit: hour/time)}$

If I want to know how many times 96W Macbook Pro could be recharged.

$$5120\text{Wh} * 90\% * 90\% / 96\text{W} = 43 \text{ times}$$

- What is the depth of discharge (DoD)?

To extend the battery-life, the power station set the 90% DOD, which means that only 90% of the battery capacity can be discharged. 10% of the energy is reserved to avoid damage to the battery due to over-discharge.

η indicates local inverter efficiency. $\text{DOD}=90\%$, $\eta =90\%$.

10. UPS

10.1. UPS Description

An uninterruptible power supply or uninterruptible power source (UPS) is an electrical apparatus that provides emergency power to a load when the input power source or mains power fails. A UPS differs from an auxiliary or emergency power system or standby generator in that it will provide near-instantaneous protection from input power interruptions, by supplying energy stored in batteries, supercapacitors, or flywheels.

10.1.1. FYI (For Your Information)

Battery SOC High indicates the limit of capacity of the unit which can be recharged by grid, if you set the Battery SOC High at 80% at Customized Mode, then EP500 could be charged to 80% via grid. The rest of the 20% capacity will be recharged via solar panels.

10.1.2. UPS working system introduction

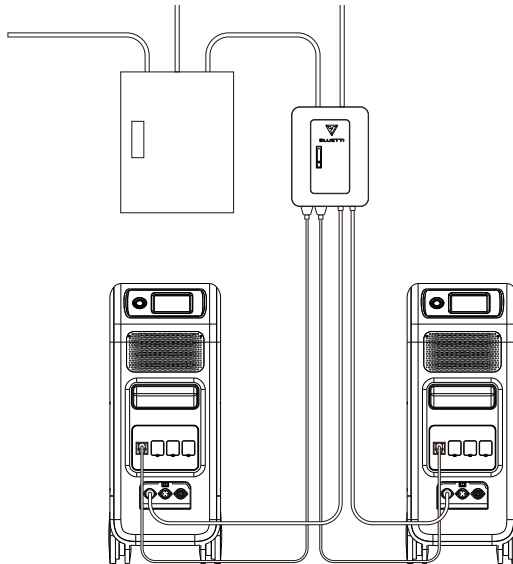

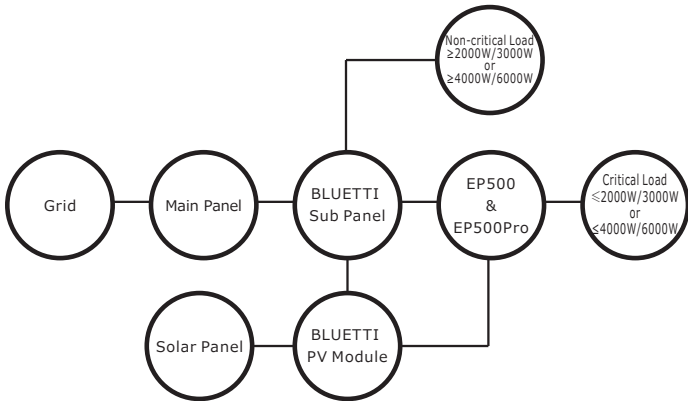

(EP500 grid-tied home power back-up system with Sub Panel and roof panels)

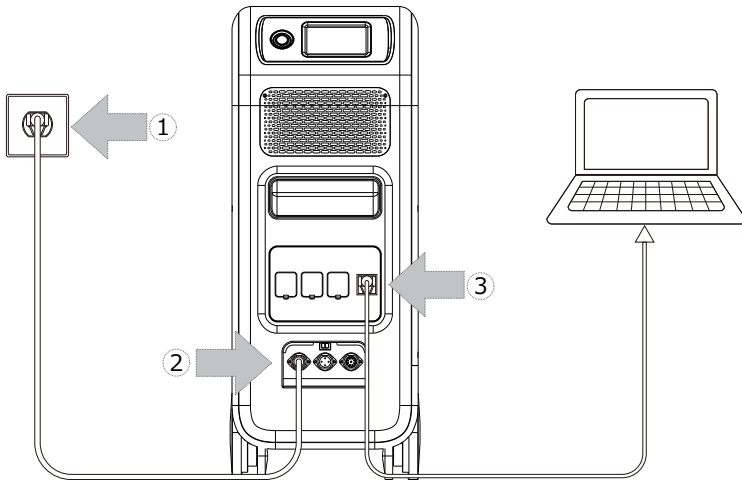

(Easy Plug-in UPS system)

Step1: Plug the AC charging cable into wall outlet

Step2: AC charging cable into AC input port(left one)

Step3: Connect the load to EP500 via AC output port

Note: The output power in Plug-in UPS Mode is subject to the specification of the current and voltage from home circuit.

a, PV Priority Mode b, Offline Standard UPS Mode

c, Time Control UPS Mode d, Customized Mode(out of discharge time)
E.g.: Current (15A) X Voltage (120V) = 1800W (in US)

10.1.3. Turn On UPS Function

- Select “Setting” on the main touchscreen interface. Select “Next” and select “Running Mode” to choose UPS Mode.
- The default working mode is “UPS Mode”.



10.2. Enable UPS Running Mode

10.2.1 Standard UPS Mode

- Offline UPS: Basic UPS working mode
EP500 will power your load or grid only when the power failure happened, or EP500 will always be on standby and keep the capacity stayed at 100%.
- Online UPS: For better electricity quality
EP500 will charge from the grid when available.
Power for the load or home will come from the EP500 (not the grid), regardless of whether there is a power outage or not.

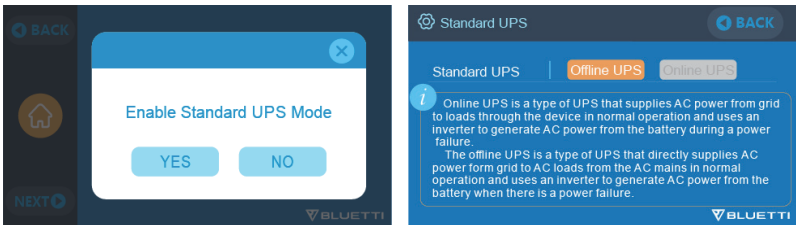

10.2.2. PV Priority Mode

- PV Priority Mode: recommended for areas in stable power supply, the battery will be recharged mainly via PV for power saving.
- Note: In PV Priority Mode EP500 can only be recharged via grid to 20 % capacity, and discharge to 20% of the capacity (you can tweak it to 100% for full grid charging manually on screen or App) as the Reserved capacity setting in PV priority Mode. And rest of the capacity will be fully charged by solar power and 2nd adaptor only.**

- User can set the Reserved capacity at 100% to let EP500 always be charged to 100% capacity via both grid and solar power.

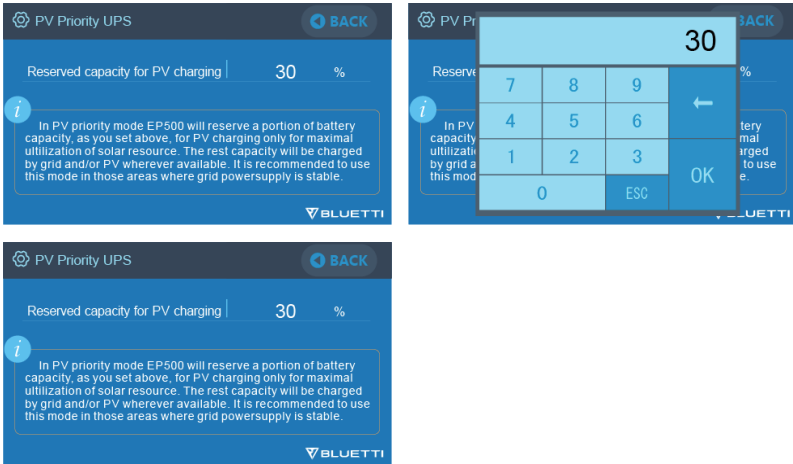

10.2.3. Time Control UPS

- Set the times of the EP500 to be charged via grid power and the times to run loads from its battery.

Charge Time: set the time of EP500 when to be recharged by grid to avoid the higher electricity bills charged.

Discharge Time: the time to generate power from its inside battery pack to power the loads connected on AC output port of EP500 or Sub Panel (optional purchase).

- Parameter Setting:

Battery SOC Low: When the remaining capacity of EP500 is under the preset

Battery SOC Low state, EP500 will stop powering loads connected to AC output port of EP500 or Sub Panel.

Battery SOC High: The maximum capacity EP500 can be charged via grid, EP500 will be charged to 100% capacity via solar power or 2nd adapter only.

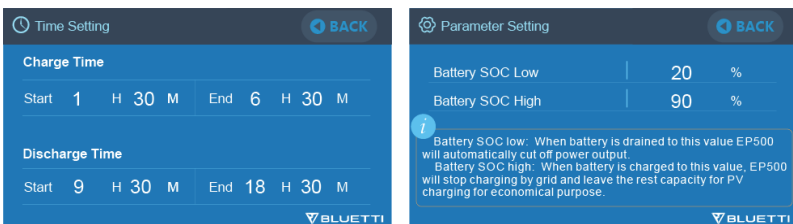

10.2.4. Customized UPS

- Charge/discharge time, and High/Low Battery SOC can be set at Customized UPS.
- Disable the grid charge setting, EP500 will not be able to be recharged by grid.
- Apart from Time Control UPS, the main switch of grid charging and time mode settings are involved. The setting of turning the grid/time setting ON/OFF will take effect on both PV Priority Mode, Standard UPS Mode, and Time Control Mode.

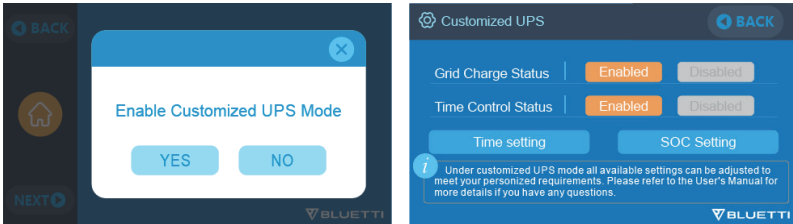

11. Split Phase Function

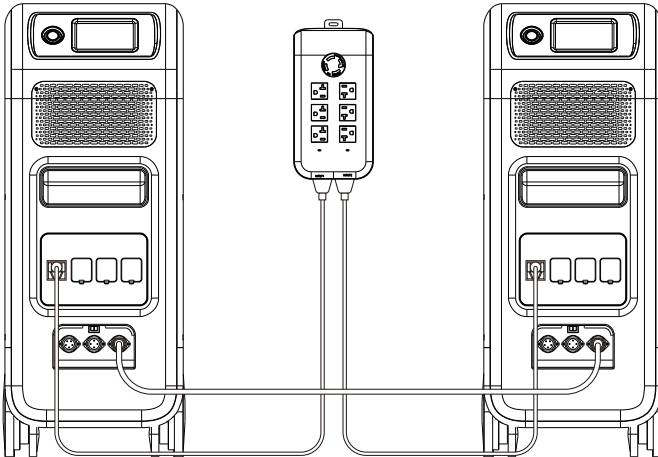

- The “Machine Type” setting on screen is used to enable or disable Split Phase output.
Split-Phase output is achieved by bonding two EP500 into one power system to double the available output power, voltage, and capacity.
- “Split Phase” is only used for connecting both *2 EP500 together (exclusive for the 100-120V version of the EP500). A Fusion Box is required (sold separately).

●Launch Split Phase Function:

Note: Only one touchscreen will be active when two EP500 units are connected.

If one of the EP500 is out of power, the Split Phase Bonding function will be invalid.

Step 1: Plug the output cables from each of the two EP500 to the Split Fusion box.

Step 2: Plug the communication cables from each of the two EP500's to the Split Fusion box.

Step 3: Set the Machine Type to "Split Phase" on EP500 either.

Step 4: Select "Master" or "Slave" on the operating EP500. Select "Master" will set the operating EP500 as the one to control both two EP500. Select "Slave" will set the operating EP500 as the other EP500 as the "Master" one.

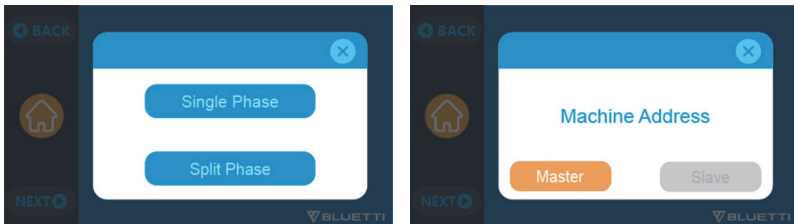

12. Technical Specification

Model	EP500-JP	EP500-US	EP500-EU/UK/AU
Net Weight	76kg (167.5lbs)		
Dimensions	580*300*760mm (22.8*11.8*29.9in)		
Charge Temperature	0-40°C (32-104 °F)		
Discharge Temperature	-20-40°C (-4-104 °F)		
Storage Temperature	-25-40°C (-13-104 °F)		
Working Environment Humidity	10-90%		
Certification	PSE, FCC, CE, UN38.3, msds, UL, SAA and ROHS		
Capacity	5120Wh (50Ah)		
Battery Type	LiFePO4		

Standard Battery Voltage	51.2VDC		
Battery Cell Voltage Range	40.0-58.4VDC		
Short-circuit Protection	Included		
Over-temperature Protection	Included		
MPPT	Built-in		
Over-temperature Protection			
Discharge Over-temperature	65°C		
Discharge Over-temperature Recovery	55°C		
Charge Over-temperature	55°C		
Charge Over-temperature Recovery	45°C		
AC Output			
AC Inverter	*4 2000W total		*3 2000W total
Rated Output Voltage	100VAC	120VAC	220-240VAC
Rated Output Frequency	50/60Hz		
Rated Continuous Power	2000W		
Rated Output Current	20A	16.7A	8.7A
Power of Over-load	2500W < load < 3000W, 8-10s; 3000W < load < 4800W, 500ms		
Efficiency	>90%		
THD	<5%		
DC Output			
Cigarette Lighter Port	*1 12VDC/10A		
DC 5521	*2 12VDC/10A		
USB-A	*2 5VDC/3A total		
USB-A	*2 18W		
USB-C (Type-C)	*1 20VDC/5A; 5-15VDC/3A		
Wireless Charging Pad	*2 5W/7.5W/10W/15W		
RV Port	*1 12VDC/30A		400W>load, 2S
Note: Cigarette lighter port shares 10A current with *2 DC5521 ports in parallel circuit.			

AC Input			
Input Voltage	90-110VAC	102-132VAC	195-253VAC EU/UK/AU
Input Frequency	47Hz-63Hz		
Max. Input Current	30A		
Configurable Input Current	15A/20A/30A Preset at 15A, can be changed on screen		
AC Charging Voltage Range	90-264VAC		
AC Charging Frequency Range	47Hz-63Hz		
Power of Charging	600W		
PV Input			
Max. Input Voltage	145VDC		
MPPT Voltage Range	55-145VDC		
Max. Power of Input	1200W		
Rated Input Current	20A		

13. Storage and Maintenance

- Please turn off the unit and charge it to 50-70% capacity every time before storing it.
- To preserve the battery health, please discharge and fully charge the unit at least once every 6 months.
- Ensure proper ventilation in use or store and keep away from any combustible materials or gases.
- Do not stack anything on the top of the unit in storage or use.
- Avoid exposing the unit to rain or wet environment, and direct sunlight (32-113 °F , 0-45°C), clean and dry environment is strongly recommended.
- Dry, non-abrasive cloths to wipe will be perfect. The power station is a versatile tool for various adventures, simple cleaning would be required from time to time to keep the unit in a good condition.
- Keep the unit away from children and pets.

14. Troubleshooting

Error Code	Error List	Troubleshooting
001	PV Over Voltage	Please check if the open circuit voltage of solar panels exceeds the input voltage standard of EP500.
005	Grid Over Voltage	Please check whether the grid voltage fits the input voltage standard of EP500.
006	Grid Low Voltage	Please check whether the grid voltage fits the input voltage standard of EP500.
007	Grid Over Frequency	Please check whether the grid frequency fits the input frequency of EP500.
008	Grid Low Frequency	Please check whether the grid frequency fits the input frequency of EP500.
009	Generator Over Voltage	Please check whether the output voltage of generator fits the input frequency of EP500.
010	Generator Low Voltage	Please check whether the output voltage of generator fits the input frequency of EP500.
012	Inverter Over-load	The output power of load exceeds.
018	USB/TYPE-C/PD High Current	Please disconnect the appliances on USB ports. Clear the alarm history or restart the unit.
019	DC 12V/10A High Current	Please disconnect the appliances on DC 12V/10A ports. Clear the alarm history or restart the unit.
020	DC 12V/30A High Current	Please disconnect the appliances on DC 12V/10A ports. Clear the alarm history or restart the unit.
022	DC Output Failure	Turn on the DC after rebooting, please contact the dealer if the error still exists.
023	DC13 Output Short Circuit	Please disconnect the appliances on DC output ports.
024	BUS Start Failure	Clear the alarm history or restart the unit.
025	INV Start Failure	Turn on the AC after rebooting, please contact with the dealer if the error still exists.
026	BUS Voltage Low	Turn on the AC after rebooting, please contact with the dealer if the error still exists.

027	BUS Voltage High	Turn on the AC after rebooting, please contact with the dealer if the error still exists.
028	Inverter Voltage Low	Please check if the output of the load meets the specifications of the unit. Turn on the AC after rebooting, please contact with the dealer if the error still exists.
029	Inverter Voltage High	Please check if the output of load meets the specifications of the unit. Turn on the AC after rebooting, please contact with the dealer if the error still exists.
030	Inverter Frequency Low	Please check if the output of load meets the specifications of the unit. Turn on the AC after rebooting, please contact with the dealer if the error still exists.
031	Inverter Frequency High	Please check if the output of load meets the specifications of the unit. Turn on the AC after rebooting, please contact with the dealer if the error still exists.
033	Battery High Voltage	Please contact with the dealer if the error still exists after rebooting the unit.
034	Battery Low Voltage	Please contact with the dealer if the error still exists after rebooting the unit.
036	Fan Error	Clean or replace the fan to ensure proper ventilation. Please contact with the dealer if the error still exists after rebooting the unit.
037	NTC Error	Please leave the unit at the recommended temperature few hours to recover. Please contact with the dealer if the error still exists after rebooting the unit.
038	Calibration	Please contact with the dealer if the error still exists after rebooting the unit.
039	Inverter Over-load Protection	Please disconnect the load to make sure the output power of loads meet the limit of the unit. Click to clear the alarm history.

040	Inverter Output Short Circuit	Please disconnect the load to make sure the load has been connected properly. Click to clear the alarm history.
041	Network Address Error	Please reset the "Master"unit or "Slave"unit. Click to clear the alarm history or reboot the unit.
042	Network Communication Error	Reconnect the communication wire again. Please reset the "Master"unit or "Slave"unit. Click to clear the alarm history or reboot the unit.
043	Grid Phase Failure	Check the input wire and whether the "Master" unit or "Slave"unit can work well.
044	Network Sync Error	Reconnect the communication wire again. Please reset the "Master"unit or "Slave"unit. Click to clear the alarm history or reboot the unit.
045	PFC Error	Check whether the grid works well. Please contact with the dealer if the error still exists after rebooting the unit.
046	Grid Input Over Current	Check whether the EP500 is on. Disconnect the loads on the grid or EP500. Check whether the Max. Grid input current could work well with strips or your Air Breaker.
049	SPI Communication Error	Please contact with the dealer if the error still exists after rebooting the unit.
050	BMS Communication Error	Please contact with the dealer if the error still exists after rebooting the unit.
051	EEPROM Read_write Error	Please reset the configurations on "Settings". Please contact with the dealer if EP500 have not been recovered after rebooting.
052	DSP Parameter Misconfiguration	Please reset the configurations on "Settings". Please contact with the dealer if EP500 have not been recovered after rebooting.
057	BMS Temperature Error	Please store EP500 at the recommended temperature and leave it until the temperature inside back to the normal standard.

058	BMS Over Voltage	Please contact with the dealer if the error still exists after rebooting the unit.
059	BMS Low Voltage	Please contact with the dealer if the error still exists after rebooting the unit.
060	BMS Over Current	Please contact with the dealer if the error still exists after rebooting the unit.
061	BMS Precharge Failure	Please contact with the dealer if the error still exists after rebooting the unit.
069	USB/TYPE-C/PD Locked	Please disconnect the load to make sure the output power of loads meet the limit of the unit. Please contact with the dealer if the error still exists after rebooting the unit.
070	12V/10A Locked	Please disconnect the load to make sure the output power of loads meet the limit of the unit. Please contact with the dealer if the error still exists after rebooting the unit.

15. FAQ (Frequently Asked Questions)

- How to claim the warranty and extended warranty?

Please place your after-sale requirement as the warranty card written to the vendor where you order the product, the extended warranty(if purchased) will take effects after the default warranty is void.

- Can it be upgraded?

The firmware including ARM, DSP, IoT and BMS can be upgraded online through OTA, and the parameters of the machine will be adjusted and optimized.

- Can it be charged and discharged at the same time?

Yes, the unit supports pass-through charging function for both AC and DC outputs. We recommend to fully charge the unit at least once per month to extend battery life.

- How many UPS modes are there?

There are 4 types of UPS Mode you can choose freely, PV priority Mode,

Standard UPS Mode, Time Control Mode and Customized Mode.

There can both be set to work offline and online.

●What is the UPS switching latency?

There are two types of working conditions of Standard UPS for EP500.

No delay for online UPS; 20ms from offline UPS.

●Can I connected my two EP500 with Fusion Box to achieve double the output power, voltage and capacity.

You can connect two EP500 OR two EP500Pro with a Fusion Box. The units must be of the same type and the correct Fusion Box (P020A for EP500, P030A for EP500Pro). You cannot mix a EP500 and EP500Pro with a Fusion Box.

●Can I use third-party solar panels to charge the unit?

Yes, the third-party solar panels are available as long as they contain MC4 connectors, besides the voltage (in series or parallel) is between 55V to 145V and the maximum input power is 1200W.

If the open circuit voltage of the panels is less than 550V, you can choose PV Module to step down the voltage to achieve solar charging.

●How do I know whether my appliance can work well with the power station?

Calculate how much the continuous loads are for your appliances are in total. As long as they do not exceed the rated output power of the power station, it should work.

●How can I connect the product to my home circuit breaker box?

To install the grid-tie power system, an electrician with a professional technician certificate is required, connect the wires of critical equipment from your main electrical box to the BLUETTI Sub Panel (optional purchase).

16. Declaration

●Some changes may not be noticed specifically such as appearance or specifications due to the exterior material or hardware improvement of the product.

●Our company shall not be liable for any damage caused by force majeure such as fire, typhoon, flood, earthquake or the user's intentional negligence, misuse or other abnormal conditions.

- No compensation for damages shall be made for utilizing non-standard adapters and accessories.
- Our company will not bear all responsibilities if the damage is caused by not operating the product properly according to the use method in operation manual.
- This unit is not suitable for use on the relevant equipment or machines involving:
Personal safety, such as atomic energy devices, aerospace devices, transportation devices, medical devices, etc., or any equipment or machines that require highly reliable power sources. We are not responsible for accidents, fires, or wrongful or negligent actions done to the machine and equipment which results in damage.

