



LITHIUM BATTERY MODULE

USER MANUAL

M12-400
M12-200



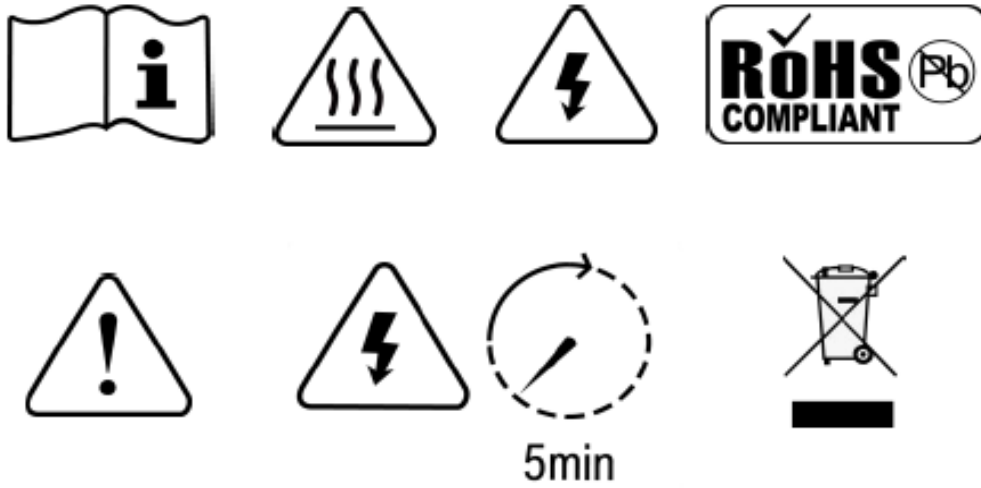

WARNING:HIGH VOLTAGE IN SIDE

CAUTION:THE DC FUSE MUST HAVE BEEN TURNED OFF BEFORE SERVICING

MADE IN CHINA

Preface

The M12 series lithium iron phosphate battery system is a standard and high performance lithium battery system. It supports parallel connection. It has obvious advantages in terms of safety, energy density, service life, and environmental protection. With an intelligent battery management system, it provides customers with a safe and stable one-stop power supply guarantee service.

This user manual introduces in details of product structure, parameters, basic procedures and methods of installation, as well as operation and maintenance of product.

Please follow below request during the procedure of installation, operation and maintenance:

- Please connect wires properly while installation, do not reverse connect. To avoid short circuit, please do not connect positive and negative poles with conductor(Wires for instance).
- Please do not mixed-use batteries from different manufacturers, different types or models, neither nor old and new together.
- The M12 series lithium batteries support the same battery model in parallel connection, but series connection is prohibited.
- Please ensure that the electrical parameters of the related equipment are compatible with each other before use.
- If the long-term storage exceeds 3 months or the battery is not fully charged for 3 months ,the battery shall be maintained before use (after the battery is charged to 100,keep the charger on for more than 8 hours).If it is necessary to the continue storage ,the battery shall be adjusted to 80% SOC.
- For your safety, please do not arbitrarily dismantle any components in any circumstances unless a specialist or an authorized one from TBB Power. Device breakdown due to improper operation will not be covered under warranty



The product has been strictly inspected before shipment. If you find abnormal phenomena such as swelling of the shell, please contact the sales or TBB Power. The use environment and storage method have a certain impact on the service life and reliability of this product, so environmental factors must be fully considered before installation and use to ensure that the system works in a suitable environment.

Disclaimer: Due to the continuous update and improvement of products and technologies, the content in this document may not completely match the actual product, please understand. For product updates, please contact your sales or TBB Power.

Content

1. Safety Precautions	1
1.1 Safety Precautions	1
1.2 General safety precautions.....	1
1.3 Disposal	1
2. Product Introduction	2
2.1 Brief introduction	2
2.2 Features.....	2
2.3 Product dimensions.....	2
2.4 External interface definition	4
2.4.1 CAN/RS485 interface definition	4
2.4.2 Indicator light definition.....	5
2.5 Optional accessories	6
2.5.1 Typical wiring.....	6
2.5.2 Power cable installation package (optional).....	6
2.5.3 MEH-B display panel (optional)	8
2.5.4 Remote battery switch (optional)	9
3. Product installation	10
3.1 General description	10
3.2 Unpacking inspection	10
3.3 Positioning and perforation.....	11
3.4 Installation fixed	11
3.5 Single lithium battery wiring.....	12
3.5.1 Typical wiring diagram of single battery	12
3.5.2 Power cable wiring	13
3.5.3 Communication cable wiring.....	13
3.5.4 Power ON and Power OFF.....	13
3.6 Connect lithium batteries in parallel	14
3.6.1 Lithium battery parallel connection diagram.....	14
3.6.2 Power cable wiring	15
3.6.3 Communication cable wiring.....	16
3.6.4 Power ON and Power OFF.....	16
3.7 Disconnect the lithium battery	16
4. Battery maintenance	17

4.1 General description	17
4.2 Security check.....	17
4.3 Surface clean	17
4.4 Not used for a long time	17
4.5 Use the battery in a low temperature environment	17
4.6 Over-discharged of battery	17
5. Storage	18
6. Transportation	18
7. Disposal or Recycle	18
8. FAQ.....	19
8.1 Lithium battery failure quick check.....	19
9. Specification.....	22

1. Safety Precautions

1.1 Safety Precautions

- Please pay attention to the safety signs on this product and manual.
- During product installation, operation, and maintenance, electrical safety regulations and related operating procedures must be observed, otherwise it may cause personal injury or product damage. The safety precautions mentioned in the manual are only a supplement to the safety regulations.
- The manufacturer does not assume any responsibility caused by violation of general safety operation requirements or violation of safety standards for design, production and use of equipment.

1.2 General safety precautions

- Please strictly follow the requirements of this manual to dispose of lithium batteries.
- Do not short-circuit lithium batteries.
- Lithium batteries must be installed in a dry and clean environment. It is strictly forbidden to put the battery in water or fire to avoid explosion or other dangers.
- Please do not stab, hit, trample or strike the battery in any other way. Avoid direct sunlight.
- Please do not remove the lithium battery from the original packaging before use.
- Ensure that the positive (+) and negative (-) polarities of the lithium battery and the charging and discharging equipment are correctly connected.
- It is forbidden to use lithium batteries of different manufacturers, models, capacities, and types in parallel.
- Do not charge the lithium battery for a long time when not in use.
- When charging the lithium battery, be sure to use the correct charger and charging voltage. It is recommended to use the power supply equipment manufactured by TBB.
- During use, when the system needs to be moved or rewired, the power must be completely cut off and the system must be completely shut down, otherwise there will be a risk of electric shock.
- Do not place metal tools on the battery. Sparks or short circuits can cause an explosion.
- In order to avoid fire and electric shock, please ensure that all cables have good electrical characteristics and suitable wire diameter; it is forbidden to use damaged or too small cables.
- When encountering a fire, please use a dry powder fire extinguisher to extinguish the fire. The use of a liquid fire extinguisher may cause secondary hazards.



Lithium batteries should be kept away from water, dust and pollution sources. Please install the lithium battery in a well-ventilated environment.

1.3 Disposal



After the lithium battery is scrapped, it cannot be discarded at will, and should be sent to a special recycling station for disposal treatment.

2. Product Introduction

2.1 Brief introduction

The M12 series is a 12V lithium-ion battery module. The positive electrode of the battery is made of lithium iron phosphate (LiFePO₄) material. It configures high-performance and high-reliability BMS to effectively manage the cells, including cell over-voltage, under-voltage, charge over-current, discharge over-current, over-temperature, low temperature, short circuit and other protection functions. It also has built-in cell voltage balance, capacity calculation, SOC calculation, cycle life accumulation and low temperature heating functions. It is suitable for energy storage systems of vehicles, ships etc.

2.2 Features

- The positive electrode of the battery is made of lithium iron phosphate (LiFePO₄) material, which has good safety performance and long cycle life. 3000 cycles @ 25°C, 0.5C charge and discharge.
- High-performance BMS with over-discharge, over-charge, over-current, temperature and other protection functions. With automatic charge and discharge management and single cell balance function.
- Supports maximum 300A discharge current.
- Supports up to 8 units in parallel.
- With external charging activation function. In the shutdown state, when the external charging voltage is >14V, the battery can actively wake up, and allow charging and prohibit discharging;
- It can be equipped with MEH-B display panel for battery switch and battery status (voltage, current, SOC) display.
- The battery has low self-discharge rate. The standby power consumption after the battery is turned on is <50mA, and it can be reduced to <0.1mA after the battery is turned off.
- Wide working temperature range, -30°C ~ +60°C. Good cycle life and discharge performance at high temperature.
- Built-in low temperature heating element, with TBB power supply system, can realize automatic battery thermal management under low temperature conditions. With external power supply (mains power, solar energy, vehicle engine), the battery temperature can be automatically heated to meet the requirements of charging and discharging under low temperature conditions. It will take about 90 minutes from -20°C to +5°C.
- The battery has small size, light weight and high energy density.

2.3 Product dimensions



Figure 2-1 Picture of M12 lithium battery

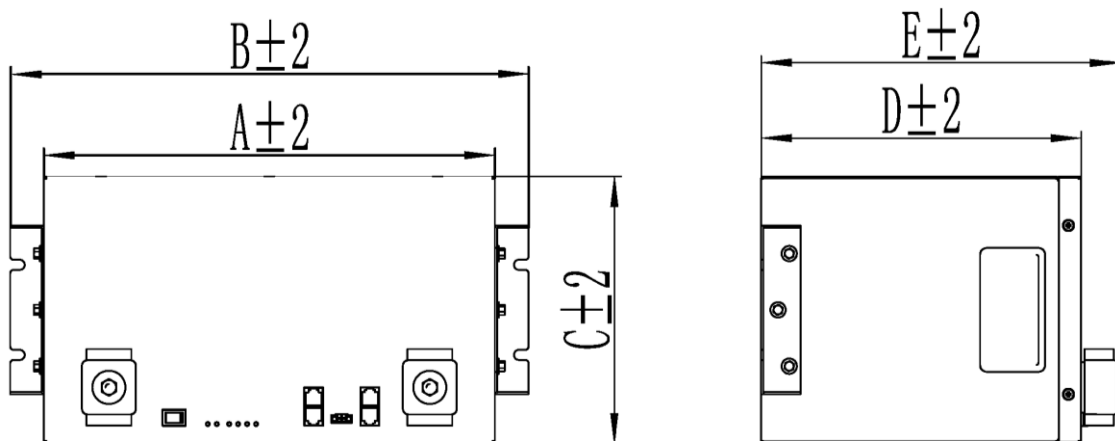

Figure 2-2 Dimensions of M12 lithium battery

Table 2-1 Description of dimensions

	A	B	C	D	E
M12-200	320	380	230	287	328
M12-400	402	462	237	285	326.5

2.4 External interface definition

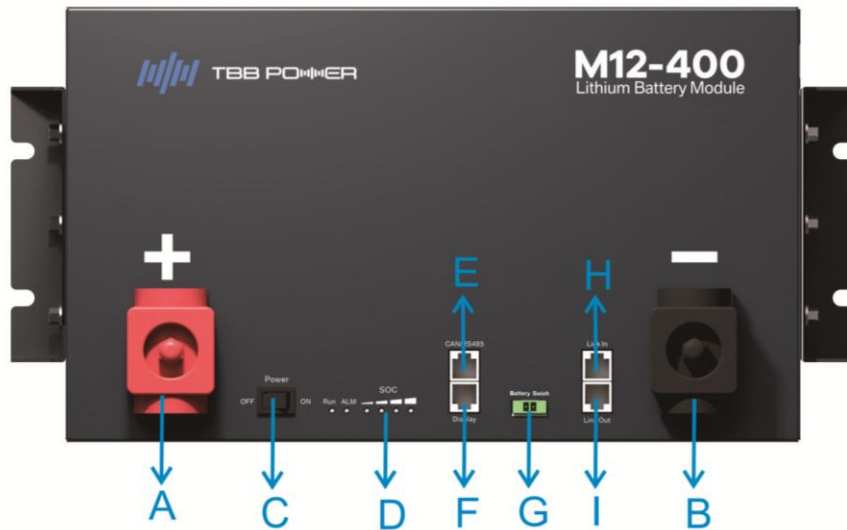



Figure 2-3 M12 lithium battery external interfaces

Table 2-2 External interface description

No.	Silk screen		Name	Definition
A	+		Positive terminal	Battery output positive or parallel positive, M8
B	-		Negative terminal	Battery output negative or parallel negative, M8
C	Power	ON OFF	Battery power switch button	Turn to the "ON" position when in use, and to the "OFF" position when shutting down
D	Run		Running indicator	Green light, flashing when standby, always on when charging, flashing when discharging; see 2.4.2 for details
	ALM		Fault indicator	Red light, always flashing when warning. Generally, it can be automatically restored after the condition that triggers the protection is lifted; see 2.4.2 for details
			SOC indicator	The number of green lights shows the remaining battery power, see 2.4.2 for details
E	CAN/RS485		External communication port	External communication port, support CAN and RS485 communication
F	Display		MEH-B interface	MEH-B display interface
G	Battery Switch		Remote switch interface	Remote switch interface, connect to battery switch, can remotely switch off the lithium battery
H	Link In		Parallel communication interface	Connect to the Link Out in the previous battery
I	Link Out			Connect to the Link In in the next battery

2.4.1 CAN/RS485 interface definition

Table 2-3 CAN/RS485 interface definition

Pin terminal	Color	Definition
PIN1	orange/white	--
PIN2	orange	--
PIN3	green/white	RS485A
PIN4	blue	CANH
PIN5	blue/white	CANL
PIN6	green	RS485B
PIN7	brown/white	--
PIN8	brown	--

2.4.2 Indicator light definition

Table 2-4 Indicator light definition

Battery status	SOC	LED1	LED2	LED3	LED4	ALM	RUN
Shut down		OFF	OFF	OFF	OFF	OFF	OFF
Power-on static state	$75\% \leq \text{SOC} \leq 100\%$	ON	ON	ON	ON	Flashing when there is a fault, always off when normal	Flashing1
	$50\% \leq \text{SOC} < 75\%$	ON	ON	ON	OFF		Flashing1
	$25\% \leq \text{SOC} < 50\%$	ON	ON	OFF	OFF		Flashing1
	$0\% < \text{SOC} < 25\%$	ON	OFF	OFF	OFF		Flashing1
	SOC=0	OFF	OFF	OFF	OFF		Flashing1
Charging	SOC=100%	ON	ON	ON	ON		ON
	$75\% \leq \text{SOC} < 100\%$	ON	ON	ON	Flashing2		ON
	$50\% \leq \text{SOC} < 75\%$	ON	ON	Flashing 2	OFF		ON
	$25\% \leq \text{SOC} < 50\%$	ON	Flashing2	OFF	OFF		ON
	$0\% \leq \text{SOC} < 25\%$	Flashing2	OFF	OFF	OFF		ON
Discharging	$75\% \leq \text{SOC} \leq 100\%$	ON	ON	ON	ON	Flashing3	
	$50\% \leq \text{SOC} < 75\%$	ON	ON	ON	OFF	Flashing3	
	$25\% \leq \text{SOC} < 50\%$	ON	ON	OFF	OFF	Flashing3	
	$0\% < \text{SOC} < 25\%$	ON	OFF	OFF	OFF	Flashing3	
	SOC=0	OFF	OFF	OFF	OFF	Flashing3	
<p>Remark: Flashing 1: on 0.25s, off 3.75s Flashing 2: on 0.5s, off 0.5s Flashing 3: on 0.5s, off 1.5s</p>							

2.5 Optional accessories

2.5.1 Typical wiring

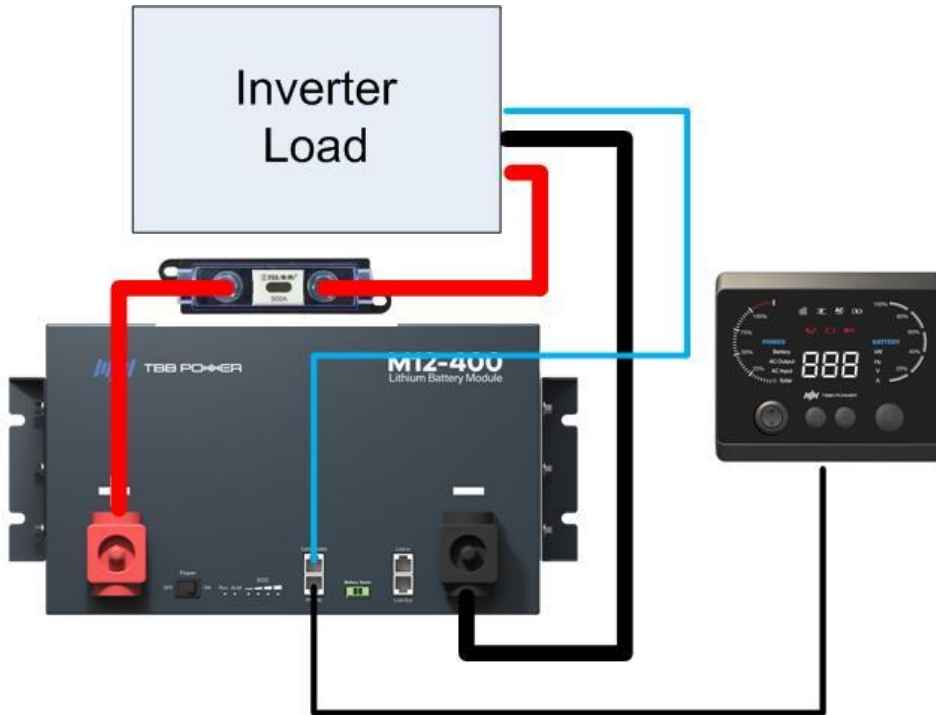





Figure 2-4 Typical wiring diagram

2.5.2 Power cable installation package (optional)

Table 2-4 Power cable installation package list

Name	Model/Specification	Picture	Q'ty
Fuse holder	BANL-B		1
Fuse	ANL500,500A/32V		1
Power cable	70mm ² ,0.4m,red. Braided cable, soft and easy to bend, easy to install.		1

To connect the fuse, please follow the steps below:

Step 1: Open the protective cover of the fuse holder, as shown in Figure 2-5.



Figure 2-5 Open the protective cover of the fuse holder

Step 2: Install the fuse and power cable, the recommended torque is 15N.m, as shown in Figure 2-6.



Figure 2-6 Install the fuse and power cable

Step 3: Remove the protective cover of the lithium battery (+) terminal, as shown in Figure 2-7.



Figure 2-7 Remove the protective cover of the lithium battery

Step 4: Connect the other end of the power cable to the lithium battery (+) terminal. The recommended torque is 15N.m, as shown in Figure 2-8.



Figure 2-8 Connect the power cable to the lithium battery (+) terminal

2.5.3 MEH-B display panel (optional)

An external MEH-B display panel can be used as the display unit of the lithium battery, which can display the current operating information of the lithium battery. It is connected to the lithium battery through a UTP standard network cable.

The MEH-B display panel has a built-in Bluetooth module, and the operating status of the lithium battery can be monitored through the APP.



Figure 2-9 MEH-B display panel

When using MEH-B as an external display unit of lithium battery, please follow the steps below:

Step 1: Use UTP standard network cable to connect MEH-B and lithium battery Display interface.

Step 2: Please turn the Power switch on the lithium battery to ON.

Step 3: You can directly use the rocker switch on the MEH-B display panel to turn on and off the lithium battery.

2.5.4 Remote battery switch (optional)

The remote battery switch can be connected to the Battery Switch interface, and the battery can be turned on and off through the remote battery switch.



Figure 2-10 Remote battery switch

To use the remote battery switch, please follow the steps below:

Step 1: Please turn the Power switch on the lithium battery to ON;

Step 2: Please connect the remote battery switch to the dry contact connector, as shown in Figure 2-11.the lithium battery can be turned on and off through the remote battery switch.



Figure 2-11 Schematic diagram of battery switch installation and wiring

3. Product installation

3.1 General description



Limited to 12V system use. It is forbidden to install and use in series!

Do not install or use damaged lithium batteries!





Please make sure that the polarity connection between the lithium battery and the charger and load is correct!

When using lithium batteries in parallel, be sure to use lithium batteries of the same brand, model, cycle life, capacity and SOC status.

3.2 Unpacking inspection

Check whether the lithium battery is in good condition after unpacking. If the lithium battery is damaged, please contact your dealer or our company. Do not install or use damaged lithium batteries!

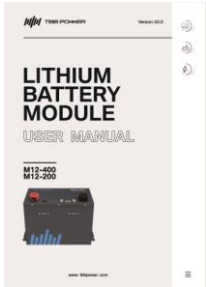
Please check whether the accessories are complete according to the packing list. If the accessories are not complete, please contact your dealer or our company.

Name	Specification	Q'ty	Picture
Lithium battery	M12 Lithium battery	1	
Battery Switch short wires	/	1	
User manual	M12 Lithium battery user manual	1	
Bolt	M8×16	4	

3.3 Positioning and perforation

Please select a plane and drill holes according to the installation positioning requirements in Figure 3-1.

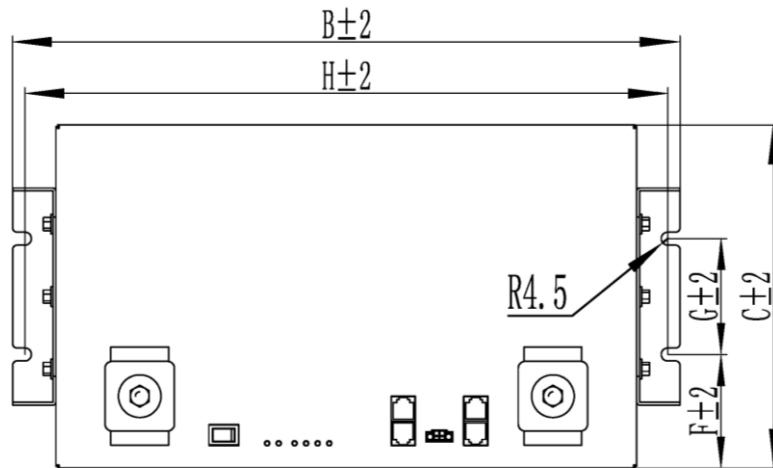

Figure 3-1 Installation positioning requirement

Table 3-1 Dimension of mounting holes

	H	B	C	F	G
M12-200	363	380	230	75	80
M12-400	445	462	237	78.5	80

3.4 Installation fixed

Before use, the lithium battery must be effectively fixed and cannot be fixed upside down. The fixing bolt is M8 and the fixing torque is 15N.m. The specific fixing position is shown in Figure 3-2.



Figure 3-2 Fixing of lithium battery

3.5 Single lithium battery wiring

3.5.1 Typical wiring diagram of single battery

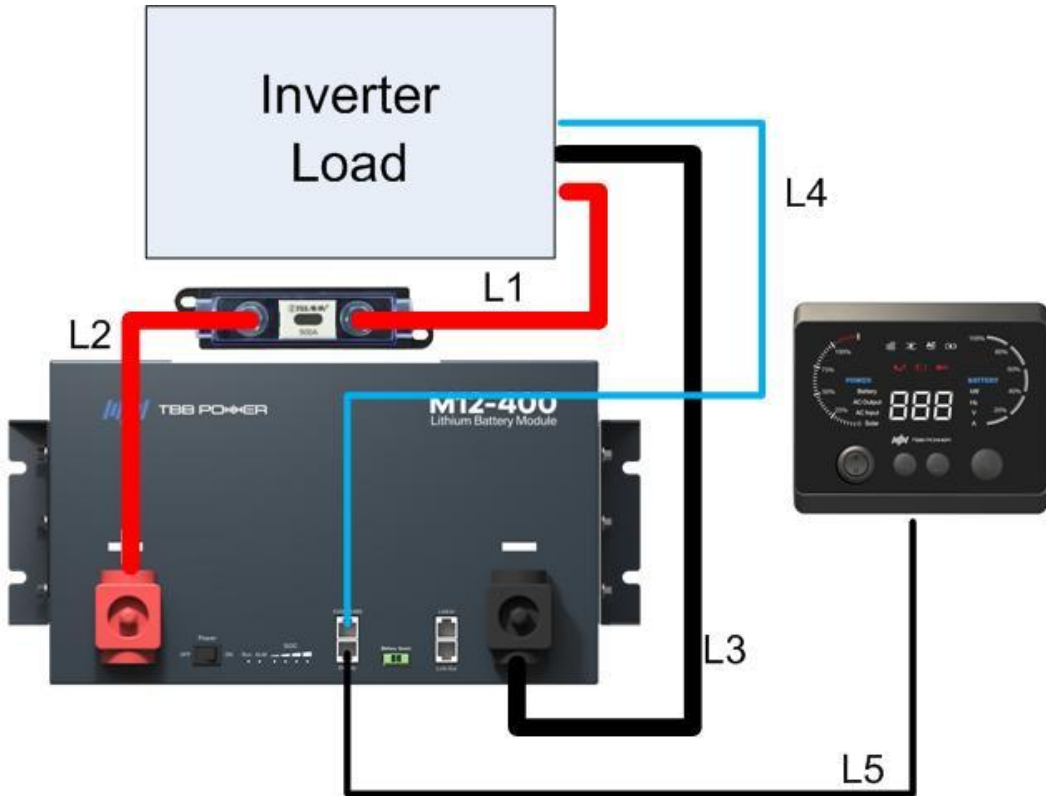

Figure 3-3 Typical wiring diagram

Table 3-2 Cable requirements

	Recommended wire diameter	Recommended length	Recommended color	Recommended terminal
L1	$\geq 70\text{mm}^2$	$\leq 2.5\text{m}$	Red	70-10 copper terminal
L2	$\geq 70\text{mm}^2$	$\leq 0.5\text{m}$	Red	70-10 copper terminal
L3	$\geq 70\text{mm}^2$	$\leq 3\text{m}$	Black	70-10 copper terminal
L4	UTP standard network cable	$\leq 9\text{m}$	Blue	--
L5	UTP standard network cable	$\leq 9\text{m}$	Black	--
L6	0.75 mm^2	--	--	Remote battery switch

3.5.2 Power cable wiring



Please make sure that the rocker switch is set to OFF before wiring, and the lithium battery is in the OFF state!

Step 1: Remove the protective cover of the lithium battery (+) terminal.

Step 2: Connect the cable L1 between the fuse and the (+) terminal of the load or charger. Torque requirement: 15N.m. Make sure the wiring is tight and firm.

Step 3: Connect the cable L2 between the fuse and the (+) terminal of the lithium battery. Torque requirement: 15N.m. Make sure the wiring is tight and firm.

Step 4: Install the protective cover of the lithium battery (+) terminal.



Do not connect the (-) terminal first, otherwise it may cause a short circuit!

Step 5: Remove the protective cover of the lithium battery (-) terminal.

Step 6: Connect the cable L3 between the (-) terminal of the load or charger and the (-) terminal of lithium battery. Torque requirement: 15N.m. Make sure the wiring is tight and firm.

Step 7: Install the protective cover of the lithium battery (-) terminal.

3.5.3 Communication cable wiring

3.5.3.1 Typical wiring diagram

Step 1: Please use UTP standard network cable to connect the CAN/RS485 communication interface of the lithium battery and the corresponding interface of the inverter or system.

Step 2: Please connect the Display communication interface of the lithium battery to the MEH-B display communication interface.

Note: If you use the MEH-B display panel, do not connect to the dry contact connector (provided by TBB).

3.5.4 Power ON and Power OFF

3.5.4.1 Typical wiring diagram

Power ON the battery: please turn the Power switch on the lithium battery to the ON position; and turn the rocker switch on the MEH-B to the "I" position;

Power OFF the battery: please turn the Power switch on the lithium battery to OFF position; or turn the rocker switch on MEH-B to "O" position;

3.6 Connect lithium batteries in parallel

3.6.1 Lithium battery parallel connection diagram

The maximum number of lithium batteries in parallel is 8. To ensure the current sharing of lithium batteries in parallel, please follow the installation and wiring requirements below.

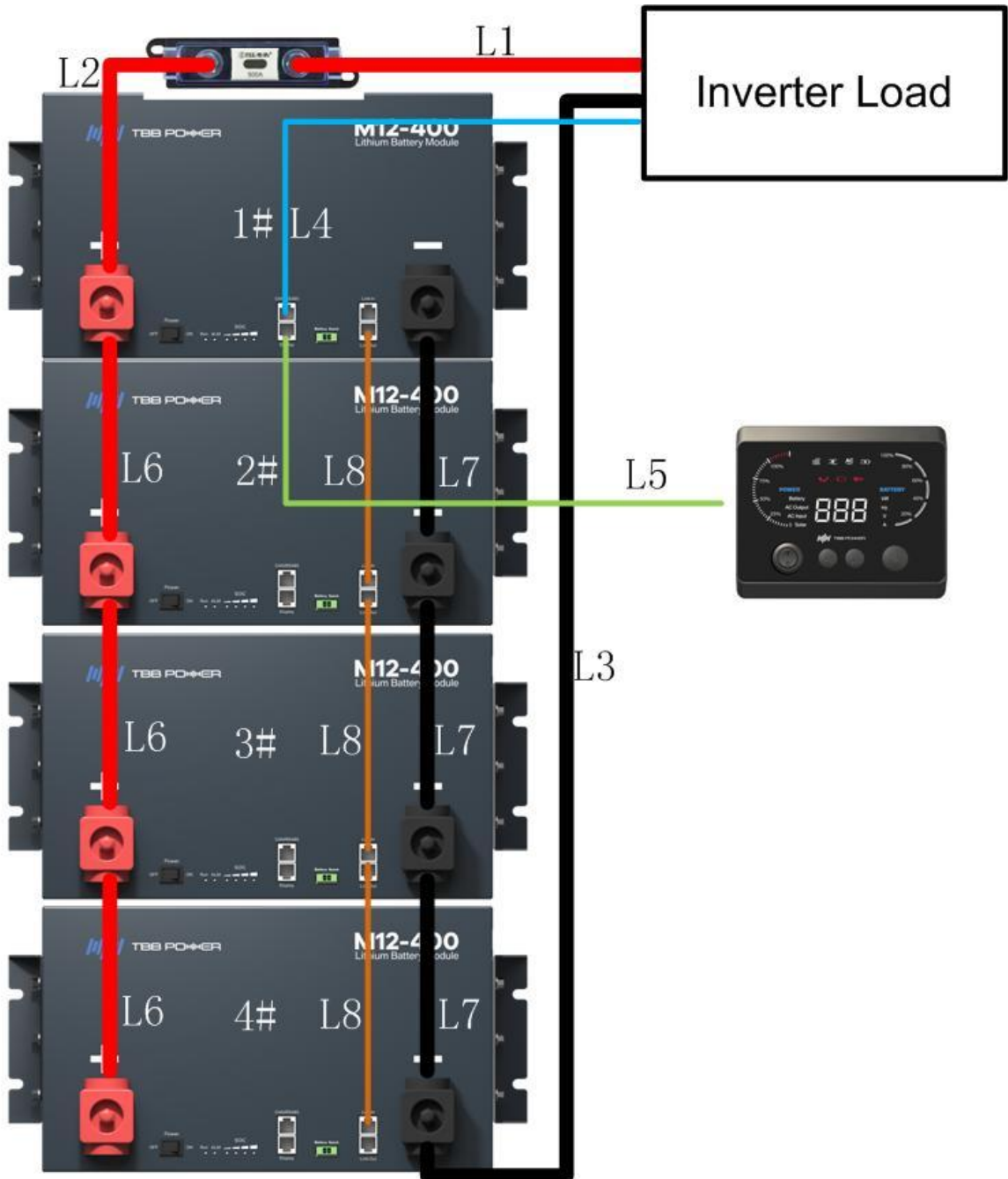

Figure 3-4 Parallel wiring diagram

Table 3-3 Cable requirements ($I_{bat} \leq 300A$)

	Recommended wire diameter	Recommended length	Recommended color	Recommended terminal
L1	$\geq 70\text{mm}^2$	$\leq 2.5\text{m}$	Red	70-10 copper terminal
L2	$\geq 70\text{mm}^2$	$\leq 0.5\text{m}$	Red	70-10 copper terminal
L3	$\geq 70\text{mm}^2$	$\leq 3\text{m}$	Black	70-10 copper terminal
L4	UTP standard network cable	$\leq 9\text{m}$	Blue	--
L5	UTP standard network cable	$\leq 9\text{m}$	Orange	--
L6	$\geq 70\text{mm}^2$	0.25m	Red	70-10 copper terminal
L7	$\geq 70\text{mm}^2$	0.25m	Black	70-10 copper terminal
L8	UTP standard network cable	$\leq 9\text{m}$	Black	--

Table 3-4 Cable requirements ($I_{bat} \geq 300A$)

Model	Recommended BAT wiring					
	3 meters		5 meters		7 meters	
300A	2/0AWG	70mm ²	3/0AWG	95mm ²	3/0AWG	95mm ²
350A	3/0AWG	120mm ²	4/0AWG	120mm ²	4/0AWG	150mm ²
400A	4/0AWG	150mm ²	4/0AWG	150mm ²	4/0AWG	150mm ²
450A	/	185mm ²	/	185mm ²	/	185mm ²
500A	/	240mm ²	/	240mm ²	/	240mm ²

3.6.2 Power cable wiring



Please charge all lithium batteries to 100% SOC before wiring! After charging, make sure that the rocker switch is set to OFF, and the lithium battery is in the OFF state!

Step 1: Remove the protective cover of the lithium battery (+) terminal.

Step 2: Connect the parallel cables L6(positive) between the lithium batteries. Torque requirement: 15N.m. Make sure the wiring is tight and firm.

Step 3: Connect the cable L1 between the fuse and the (+) terminal of the load or charger. Torque requirement: 15N.m. Make sure the wiring is tight and firm.

Step 4: Connect the cable L2 between the fuse and the (+) terminal of the lithium battery. Torque requirement: 15N.M. Make sure the wiring is tight and firm.

Step 5: Install the protective cover of the lithium battery (+) terminal.



Do not connect the (-) terminal first, otherwise it may cause a short circuit!

Step 6: Remove the protective cover of the lithium battery (-) terminal.

Step 7: Connect the parallel cables L7(negative) between the lithium batteries. Torque requirement: 15N.M . Make sure the wiring is tight and firm.

Step 8: Connect the cable L3 between the (-) terminal of the load or charger and the (-) terminal of lithium battery. Torque requirement: 15 N.M .Make sure the wiring is tight and firm.

Step 9: Install the protective cover of the lithium battery (-) terminal.

3.6.3 Communication cable wiring

Step 1: Connect the communication cable L8 between lithium batteries (1#~4#);

Step 2: Please use UTP standard network cable to connect the CAN/RS485 communication interface of the 1# lithium battery and the corresponding interface of the inverter or system.

Step 3: Please connect the Display communication interface of the #1 lithium battery to the MEH-B display communication interface.

Note: If you use the MEH-B display panel, do not connect to the dry contact connector (provided by TBB).

3.6.4 Power ON and Power OFF

Power ON the battery: please turn the Power switch on the #1 lithium battery to the ON position; and turn the rocker switch on the MEH-B to the "I" position;

Power OFF the battery: please turn the Power switch on the #1 lithium battery to OFF position; or turn the rocker switch on MEH-B to "O" position;

3.7 Disconnect the lithium battery

Step 1: Please turn OFF the Power switches on all lithium batteries.

Step 2: Please turn off all devices or chargers connected to the lithium battery.

Step 3: Please disconnect the cables between the negative pole of the lithium battery and the load or charger.

Step 4: Please disconnect the cables between the positive pole of the lithium battery and the load or charger.

Note: If you use the MEH-B display panel, you need to disconnect the network cable between the MEH-B and the lithium battery.

4. Battery maintenance

4.1 General description

- Before cleaning and maintaining the lithium battery, be sure to disconnect all loads and charging equipment from the lithium battery.
- Before cleaning and maintenance of the lithium battery, please put a protective cover on the terminal to prevent the risk of short circuit caused by contacting the terminal during cleaning and maintenance.



Do not try to open or disassemble the lithium battery!

4.2 Security check

- Check the connection point for loose or broken wires, cracks, deformation, leakage, or other types of damage. If the lithium battery is found to be damaged, it must be replaced in time. It is forbidden to charge or use damaged lithium batteries. Do not touch the liquid leaked from a ruptured lithium battery.
- In order to enable the BMS to calculate the SOC of the lithium battery more accurately and eliminate the cumulative error of the SOC, it is recommended to complete a full discharge (discharge to 0% SOC) and full charge (charge to 100% SOC) every 3 months.

4.3 Surface clean

If you need to clean the lithium battery, please wipe the outer surface of the lithium battery with a soft, dry cloth or paper towel. Do not use liquids, solvents or abrasive tools to clean lithium batteries.



Do not try to open or disassemble the lithium battery!

4.4 Not used for a long time

- If you don't use the battery for a long time, you need to turn the rocker switch on the MEH-B to "O", or turn the Power switch on the lithium battery to "OFF" to turn off the lithium battery to avoid damage caused by over-discharge of the battery.
- When the battery is not in use for a long time, it needs to be charged to 80% capacity regularly, and the charging cycle is required to be less than 3 months.

4.5 Use the battery in a low temperature environment

- When the cell temperature is $\leq 2^{\circ}\text{C}$, the lithium battery will report a low temperature fault alarm, and the user cannot directly charge the lithium battery. In the low temperature environment, when the external charger is turned on (charging voltage 14~14.2V), the lithium battery will automatically turn on the heating function. After the automatic heating of the lithium battery is completed, the battery can be charged normally and the battery low temperature alarm will be released. For M12 lithium battery it will take about 90 minutes to heat from -30°C to a temperature that allows charging.
- When the ambient temperature is lower than -30°C , the battery cannot be discharged and a low temperature fault alarm will be reported. The user can connect an external charger to heat the battery before starting to discharge it.

4.6 Over-discharged of battery

The battery will be shut down if it hits protection threshold value of over-discharged and without being charged in 10 minutes. To wake up battery, you can turn the battery switch or rocker switch of MEH-B OFF and then ON. Please charge the battery in 10 minutes if its waken up.

If the battery is failed to be waken up, please charge the battery directly with charge voltage 14.0V or greater. The battery will wake itself up and start charging as long as it measures voltage of 14.0V or greater.

5. Storage

Please follow the storage instructions in this manual to increase the service life of the lithium battery during storage. If you do not follow the storage instructions in this chapter for storage, the lithium battery may be over-discharged and damaged. If the inspection reveals that the lithium battery is damaged, please do not try to charge or use it.

The optimum storage conditions of the battery are: 0°C~35°C, 20%~80%SOC, <65%RH;

The storage conditions for a short time (within one month) are: -20°C~45°C, 20%~80%SOC, <65%RH;

If the battery storage condition deviates from the short-term storage condition the cycle life of the battery will be affected;

The storage self-discharge rate of lithium battery is less than 3%/month.



When storing the lithium battery, please press the Power switch to OFF. Please disconnect the Battery Switch or MEH-B from the lithium battery!

- Before storing the lithium battery, please charge the battery to 80% SOC.
- Please disconnect all loads and chargers connected to the lithium battery.
- Please turn the Power switch to the OFF position, and disconnect the Battery Switch or MEH-B.
- Please cover the terminal protection cover.
- Every 3 months, please charge the battery to 80% SOC; after charging is completed, please turn the Power switch to the OFF position, and disconnect the Battery Switch or MEH-B.

6. Transportation

Before transporting lithium batteries, please check all local, national and international applicable laws and regulations.

In some cases, the transportation of scrapped, damaged or recalled lithium batteries may be specifically restricted or prohibited.

Lithium battery transportation belongs to the ninth category of dangerous goods in the UN3480 standard.

7. Disposal or Recycle

Please discharge the lithium battery to SOC 0% before discarding it. Please use electrical tape or other insulating tape to insulate the positive and negative poles of the battery to prevent short circuits.

Disposal and recycling of lithium batteries should comply with local, state, and federal laws and regulations. Lithium batteries can also be recycled to the manufacturer for disposal.

8. FAQ

8.1 Lithium battery failure quick check

Type	Flash time of fault indicator	Protection type	Suggestion
Protection	1	Output short circuit protection	<ul style="list-style-type: none"> ➤ Please check whether the positive and negative terminals of the lithium battery are connected reversely or short-circuited. ➤ If there is no wiring error, please contact your dealer.
	2	Discharge over current protection	<ul style="list-style-type: none"> ➤ Check whether the discharge current of the lithium battery exceeds the rated discharge current. If it exceeds, turn off part of the load. ➤ If the battery discharge current does not exceed the rated discharge current, please contact your dealer.
	3	Charging over current protection	<ul style="list-style-type: none"> ➤ Check whether the charging current of the charger matches the lithium battery. ➤ Check whether the charger is operating normally. ➤ If all the above are normal, please contact your dealer.
	4	Low voltage protection of the battery	<ul style="list-style-type: none"> ➤ The battery capacity is very low, please connect the charger immediately to charge the lithium battery.
	5	Cell low voltage protection	<ul style="list-style-type: none"> ➤ The battery capacity is very low, please connect the charger immediately to charge the lithium battery.
	6	High voltage protection of the battery	<ul style="list-style-type: none"> ➤ Check whether the charging voltage of the charger matches the lithium battery. The charging voltage should be 14.0~14.2V. ➤ Check whether the charger is abnormal. ➤ If all the above are normal, please contact your dealer after turning off the charger.
	7	Cell high voltage protection	<ul style="list-style-type: none"> ➤ Check whether the charging voltage of the charger matches the lithium battery. The charging voltage should be 14.0~14.2V. ➤ Check whether the charger is abnormal. ➤ If all the above are normal, please contact your dealer after turning off the charger.

Protection	8	Discharge high temperature protection	<ul style="list-style-type: none"> ➤ Please check whether the ambient temperature of the battery installation location is too high. ➤ Please check whether the battery wiring is tight and reliable. ➤ Please check whether the wire diameter of the battery wiring cable meets the requirements of the manual. ➤ Please check whether the discharge current and discharge time of the lithium battery exceed the specified requirements (see the technical parameter table for details) ➤ If the above is normal, please contact your dealer.
	9	Discharge low temperature protection	<ul style="list-style-type: none"> ➤ Please check whether the ambient temperature of the battery installation location is lower than -30°C. If so, please connect the charger and increase the temperature of the lithium battery by heating the internal heating film of the lithium battery. ➤ If the problem still cannot be solved, please contact your dealer.
	10	Charging high temperature protection	<ul style="list-style-type: none"> ➤ Please check whether the ambient temperature of the battery installation location is too high. ➤ Please check whether the battery wiring is tight and reliable. ➤ Please check whether the wire diameter of the battery wiring cable meets the requirements of the manual. ➤ Check whether the charging current of the charger matches the lithium battery.
	11	Charging low temperature protection	<ul style="list-style-type: none"> ➤ Please check whether the ambient temperature of the battery installation location is lower than 2°C. If so, please connect the charger and increase the temperature of the lithium battery by heating the internal heating film of the lithium battery. ➤ If the problem still cannot be solved, please contact your dealer.

Protection	12	BMS circuit high temperature protection	<ul style="list-style-type: none"> ➤ Please check whether the ambient temperature of the battery installation location is too high. ➤ Please check whether the battery wiring is tight and reliable. ➤ Please check whether the wire diameter of the battery wiring cable meets the requirements of the manual. ➤ Please check whether the discharge current and discharge time of the lithium battery exceed the specified requirements (see the technical parameter table for details) ➤ If the above is normal, please contact your dealer.
	13	BMS circuit low temperature protection	<ul style="list-style-type: none"> ➤ Please check whether the ambient temperature of the battery installation location is lower than -40°C. If it is, the battery is not suitable for operation in such a low ambient temperature, and the ambient temperature for battery installation is preferably above -30°C. ➤ If the above is normal, please contact your dealer.
	14	External input over voltage protection	<ul style="list-style-type: none"> ➤ Check whether the charging voltage of the charger matches the lithium battery. The charging voltage should be 14.0~14.2V. ➤ Check whether the charger is abnormal. ➤ If all the above are normal, please contact your dealer after turning off the charger.
	15	BMS internal failure	<ul style="list-style-type: none"> ➤ Please contact your dealer.
	Continuous flashing	Parallel communication failure	<ul style="list-style-type: none"> ➤ Please check whether the parallel communication cable is correctly connected according to the manual (see chapter 3.6.1 for details). ➤ Please check whether the communication network cable is loose or damaged. You can try to replug the network cable or replace it with a new communication network cable. ➤ If all the above are normal, please contact your dealer.

9. Specification

Model	M12-200	M12-200/H	M12-400
Cell type	LiFePO4		
Rated capacity	200Ah		400Ah
Rated power	2.56kWh		5.12kWh
Rated voltage	12.8V		
Charging voltage	14.2V		
Maximum charging current	200A		
Continuous discharge current	200A		
Maximum discharge current (10 minutes)	300A		
Cell operating temperature (charging)	2°C~60°C		
Cell operating temperature (discharging)	-30°C~60°C		
Storage temperature range (<1 month)	-20°C~45°C,20%~80% SOC,<65% RH		
Storage temperature range (<6 months)	-20°C~35°C,20%~80% SOC,<65% RH		
Operating humidity range	10%~90% RH		
Dimensions	380*230*328mm		462*237*326.5mm
Weight	25.5kg		42.5kg
IP protection	IP20		
Certifications	CE、UN38.3		CE、UL、UN38.3
Shipping class	UN3480		
Cycle life	>3000(0.5C charge and discharge, DoD100%, @25°C)		
Heating element	NO	YES	YES
Maximum number of parallel	8		
Display unit (Optional)	MEH-B		

TBB POWER CO.,LTD

 service@tbbpower.com

 www.tbbpower.com

 +86-592-5212299

 +86-592-5796070