

**T300 MAXIMUM SECURITY  
HEAVY DUTY DEADBOLTS  
FOR COMMERCIAL AND  
RESIDENTIAL APPLICATIONS**



**LIFETIME  
WARRANTY**

**MEETS**  
*The Buy American Act*

Meets ADA requirements  
Specially designed for  
Barrier Free Application  
Conforms with BHMA / ANSI  
A156.36, Grade 2 Requirements,  
Exceeds 150,000 Cycles

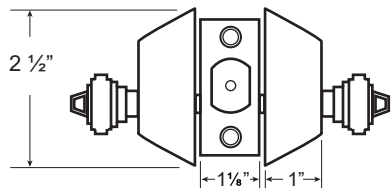
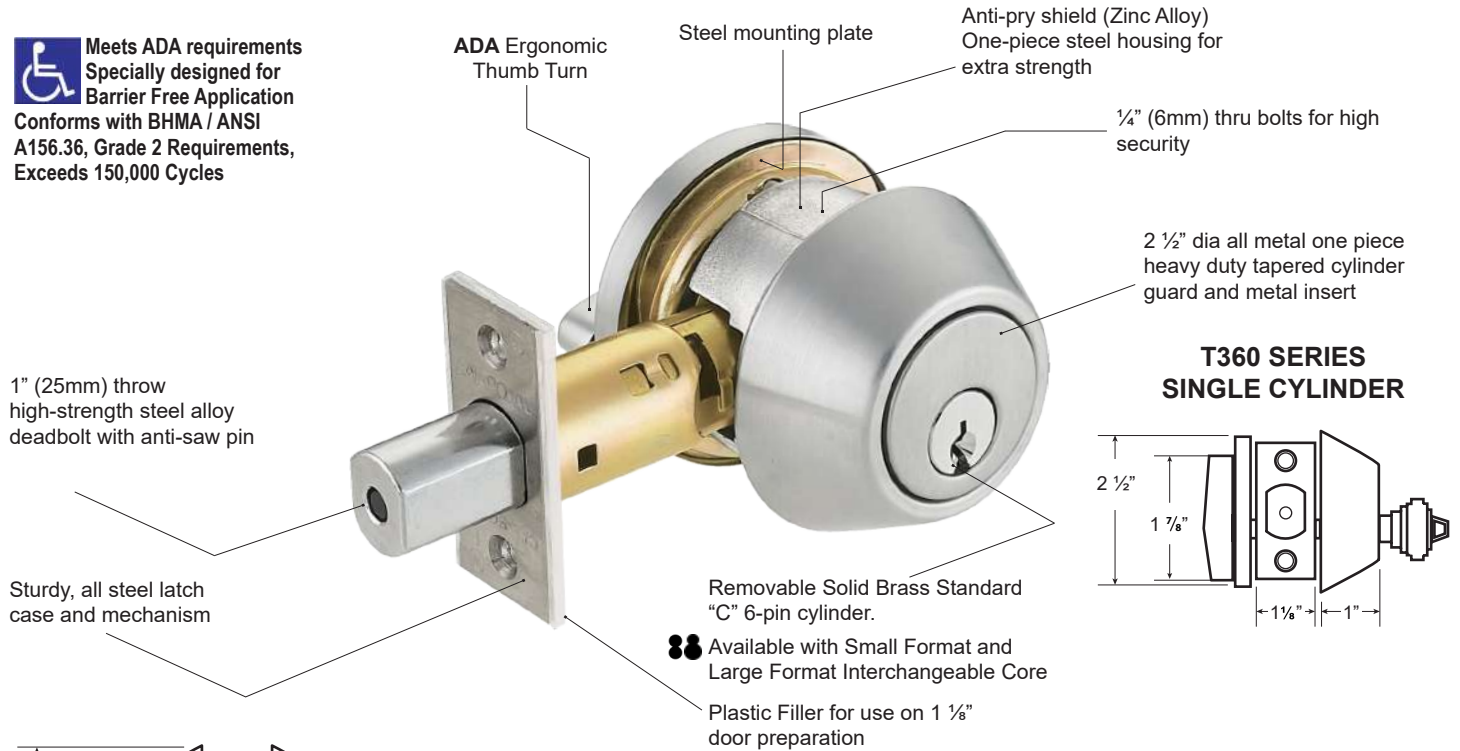

**T362 SERIES  
DOUBLE CYLINDER**



**T360 SERIES  
SINGLE CYLINDER**



CONFIGURATION	MAX FRAME DIMENSIONS	DESIGN PRESSURE (PSF)			
		INSWING		OUTSWING	
		POSITIVE	NEGATIVE	POSITIVE	NEGATIVE
SINGLE	40" x 88"	+55.0	-55.0	+80.0	-80.0
SINGLE	52" x 98"	N/A	N/A	+80.0	-80.0
DOUBLE	76" x 88"	+55.0	-55.0	+55.0	-55.0

**SPECIFICATIONS**

**TRIM**

Wrought Brass or Stainless Steel.

**DOOR RANGES**

Adjustable 1 3/8" (35mm) to 1 3/4" (45mm) door thickness. Optional 2 1/4" thick doors. Specify conversion kit for single (CONV T360) or double (CONV T362) Cylinder.

**BACKSET**

Adjustable UL Listed 3 Hour Fire Rating 2 3/8" or 2 3/4" latch bolt.

**DEADBOLT FACEPLATE**

Standard 2 1/4" X 1" packed with 1/8" plastic filler to convert 1" face plate to 1 1/8" wide door preparations.

**BORE DIAMETER**

1" for latch, 2 1/8" for lock housing.

**STRIKE**

1 1/8" x 2 3/4" square corner. Extra security 1" throw bolt with 1/4" free spinning anti-cut through pin. 2 pcs x 3" screws with wood frame reinforcer greatly strengthens door frames.

**KEYWAYS**

6 pin solid brass "C" keyway standard. Schlage E, Schlage C-K, Russwin D1-2-3-4, Corbin 59 / 60, Corbin-Russwin L4, Sargent LA-LB-LC, Falcon / Weiser E, Arrow A, Yale 8, Yale GA and Kwikset. Can also accept Medeco, Assa, Kaba and Cal-Royal (HSK) High Security Cylinders.

**INTERCHANGEABLE CORE**

- Interchangeable Core locks will accept compatible 6 or 7-Pin cores with BEST, FALCON and ARROW.
- Interchangeable Core locks will also accept SCHLAGE full size Large format OEM interchangeable core cylinders and compatible Schlage 6-pin Interchangeable Core. Interchangeable Core offered by Cal-Royal Products, Inc.

# T300 SERIES FINISHES AND FUNCTIONS



FINISHES AVAILABLE		
BHMA SYMBOL	US CODE	DESCRIPTION
622	US1	Flat Black Coated
605	US3	Polished Brass
606	US4	Satin Brass
609	US5	Antique Brass
612	US10	Satin Bronze
613	US10B	Oil Rubbed Bronze
613E	US10BE	Dark Satin Bronze, Equivalent
619	US15	Satin Nickel
625	US26	Polished Chrome
626	US26D	Satin Chrome
630	US32D	Satin Stainless Steel

Refer to price list for stock finishes and functions



**MEETS**  
The Buy American Act



**LIFETIME WARRANTY**

HURRICANE APPROVED HARDWARE  
FLORIDA BUILDING CODE  
**FL13922-R8**  
ASTM E330-02 & E1886-05/1996-06  
TAS 201, 202, 203-94  
UL10C-09

HURRICANE APPROVED HARDWARE  
TEXAS EVALUATION ID  
**DR-472**  
ASTM E330-14/  
E1886-13a/  
E1996-14a

CONFIGURATION	MAX FRAME DIMENSIONS	DESIGN PRESSURE (PSF)			
		INSWING		OUTSWING	
		POSITIVE	NEGATIVE	POSITIVE	NEGATIVE
SINGLE	40" x 88"	+55.0	-55.0	+80.0	-80.0
SINGLE	52" x 98"	N/A	N/A	+80.0	-80.0
DOUBLE	76" x 88"	+55.0	-55.0	+55.0	-55.0

**ULT360**  
● **ICULT360**  
● **SCICULT360**  
ANSI E0152

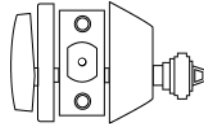

### Heavy Duty Single Cylinder Deadbolt

Deadbolt thrown or retracted by key from outside or by inside turn unit. Bolt automatically deadlocks when fully thrown.

**ULT362**  
● **ICULT362**  
ANSI E0142

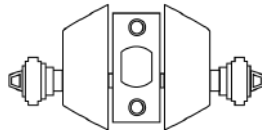

### Heavy Duty Double Cylinder Deadbolt

Deadbolt thrown or retracted by key from either side. Bolt automatically deadlocks when fully thrown.

**CL600**  
● **ICCL600**  
ANSI E0172

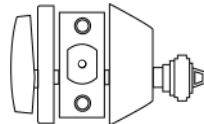

### Classroom Deadbolt Lock

Deadbolt thrown or retracted by key from outside. Inside turn unit will retract bolt only. Bolt automatically deadlocks when fully thrown.  
*(fixed 2 3/4" latch bolt standard; specify 2 3/8" backset option)*

**ULT700**  
● **ICULT700**  
ANSI E1161

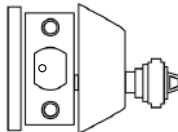

### One Way Dead Bolt WITH INTERNAL PLATE

Deadbolt thrown or retracted by key only. Bolt automatically deadlocks when fully thrown. Blank plate inside (exposed screws).

**ULID363**

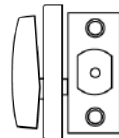

### One Sided Dead Bolt

Deadbolt thrown or retracted by turn unit only. No outside trim. Bore halfway through door for installation visible from one side of door only.

**ULID365**

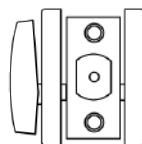

### One Sided Dead Bolt WITH EXTERNAL PLATE

Deadbolt thrown or retracted by turn unit only. Blank plate is on external trim to be used on bore holes 2 1/2" wide.

**OTHER FUNCTIONS NOT LISTED ARE AVAILABLE UPON REQUEST**

- "IC" Indicates functions available with Interchangeable Core compatible with 6 or 7-Pin cores by Best, Falcon and Arrow.
- "SCIC" Indicates functions available with Schlage Full Size Large Format Interchangeable Core.