

PROJECT:	_____
LOCATION:	_____
ITEM#:	_____
QUANTITY:	_____



FRYERS

- Robertshaw® brand electro-mechanical thermostat for adjusting temperatures within a range of 200°F to 400°F
- 34,000 BTU (natural gas) and 30,000 BTU (LP) per burner
- Beautiful ergonomic design and easy to clean
- All stainless steel tank & cabinetry
- Removable basket hanger for cleaning purposes
- Manual pilot ignition
- Auto reset high limit control for high temperatures
- Cooling zone inside the fryer tank
- Twin nickel chrome plated wire mesh baskets with blue plastic coated handles
- Built in flue deflector
- Full port drain within valve
- (4) adjustable stainless steel legs
- Comes in standard as natural gas or L.P
- Accessory: optional casters upon request
- Migali Industries® Protection Plan: 1 Year Parts & Labor Warranty, 5 Years Oil Tank Warranty

MODEL	BURNERS	VOLUME	TOTAL BTU	PER BTU (BTU/H) NATURAL GAS / LP	IN TAKE TUBE PRESSURE (W.C.) NATURAL GAS / LP	NOZZLE NO. NATURAL GAS / LP	IGNITION	VALVE TYPE	THERMOSTAT TEMP LIMIT	TEMP LIMIT	EXTERIOR DIMENSIONS W X D X H	PACKAGED DIMENSIONS W X D X H	WEIGHT	PACKAGED WEIGHT
C-F40-NG / C-F40-LP	3	40 lbs	102,000 / 90,000	34,000 / 30,000	4 / 10	#36 / #52	Manual	Often open flame, flame protection	400° F	450° F	15.6" x 30.1" x 44.4"	17.7" x 33.5" x 37.9"	131 lbs.	160 lbs.
C-F50-NG / C-F50-LP	4	50 lbs	136,000 / 120,000	34,000 / 30,000	4 / 10	#36 / #53	Manual	Often open flame, flame protection	400° F	450° F	15.6" x 30.1" x 44.4"	17.7" x 33.5" x 37.9"	144 lbs.	171 lbs.
C-F75-NG / C-F75-LP	5	75 lbs	170,000 / 150,000	34,000 / 30,000	4 / 10	#36 / #54	Manual	Often open flame, flame protection	400° F	450° F	21.1" x 30.1" x 44.4"	23.2" x 33.5" x 37.9"	168 lbs.	200 lbs.

Gas Connection: 3/4" NPT on the right
 Clearance for combustible work area: 6" rear & 15" sides
 Altitudes over 2,000 feet may need high altitude orifice adjustments to deliver BTU output listed

* MIGALI® RESERVES THE RIGHT TO CHANGE SPECIFICATIONS WITHOUT NOTICE



TOLL FREE: 800.852.5292
WEB: www.migali.com



Conforms to ANSI STD 283, 116, 2009 (2011), NSF/ANSI STD 4 & CSA STD 1-09-2009(2011)

DIMENSIONAL DRAWINGS

C-F40

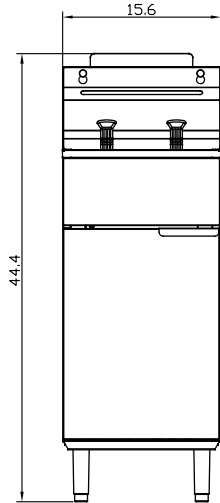

C-F50

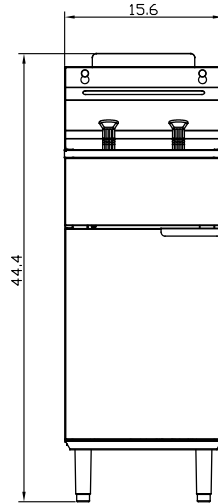

C-F75

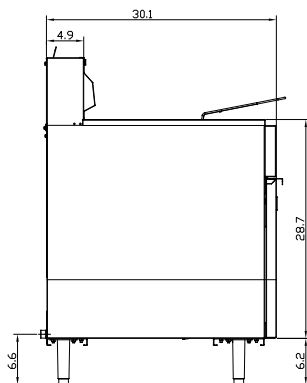
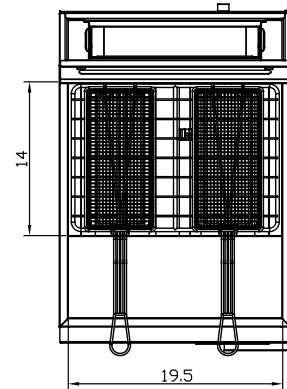
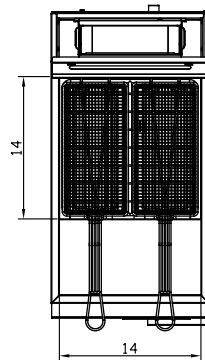
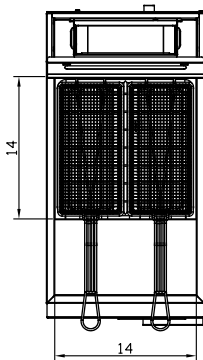
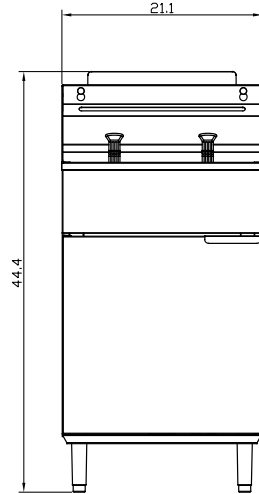

SIDE VIEW



MIGALI® REMAINS AN AMERICAN FAMILY COMPANY SINCE 1955