

FOTILE

RANGE HOOD

User Manual | JQG7502/JQG7502.G

Please read the following safety information carefully before installing and/or using this appliance.
We recommend that you keep this manual for future use and/or in case of transfer of ownership
of the range hood

Thank you!

Dear User, thank you for purchasing the Fotile Range Hood. At Fotile, we manufacture exquisite appliances that are expertly crafted with the finest materials. Before using the Fotile Range Hood, please take some time to read through this Product Manual (manual). It will familiarize you with important safety, operation and maintenance instructions, as well as help maximize your culinary experience.

Fotile's promise is to "Make Our Home Better" and therefore we ensure the continued dependable and superior performance of all Fotile appliances so as to satisfy your needs. Before using the Fotile Range Hood, you must follow the instructions, as specified in this manual. Any damage resulting from the improper operation and/or maintenance of the appliance may result in the loss of warranty. The warranty will become invalid, and your warranty application, whether direct or indirect, will not be accepted by authorized service center of Fotile. If you require warranty or post-warranty after-sale service, please contact the local authorized service center of Fotile nearest you.

Your satisfaction with the Fotile brand is important to us. Our after-sales service centers provide assistance in resolving issues with Fotile appliances.

If you would like to apply for a warranty, please provide the product's model and serial number, which can be found on the nameplate attached to the upper wall of the range hood.

Please refer to illustration below for the location of the nameplate.

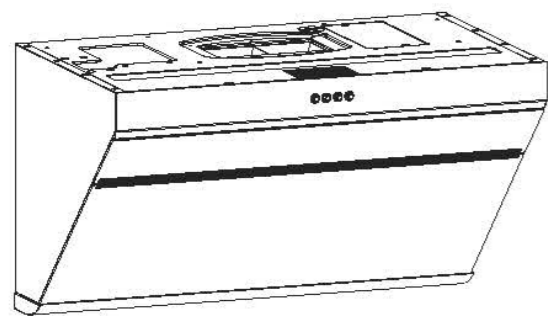

Contents

1 Safety Information	19
2 Operation	22
2.1 Product Information	22
2.2 Operation	23
3 Cleaning and Maintenance	23
4 FAQ	26
5 Service Information	26
6 Installation	26
6.1 Installation Instructions	26
6.2 Product dimensions	28
6.3 List of Accessories	29
6.4 Installation Tools.....	30
6.5 Installation Procedure	30
6.6 Test Run After Installation	37

Product features and specifications are subject to change, at any time, without notice. Please visit our website at www.fotileglobal.com for the most up-to-date information.

In order to ensure the safe and efficient use of Fotile appliances, please take note of the following types of highlighted information that will be outlined throughout this manual:

IMPORTANT NOTE highlights information that is particularly important.

CAUTION signals a situation where minor injury or product damage may occur if instructions are not followed.

WARNING states a specific hazard that may cause serious injury or death if precautions are not followed.

SAFETY INFORMATION

In order to prevent accidental damage to the Fotile Range Hood and/or bodily injuries as a result of its operation, please read the following safety information installing and/or using this appliance. Following the instructions carefully will significantly reduce the risk of fire, electric shock and/or bodily injuries to persons. We recommend that you keep this manual for future use and/or in case of transfer of ownership of the range hood.

Important Note:

- This appliance is intended for indoor home cooking only; it cannot be used for outdoor cooking.
- Check the appliance for damage after unpacking it. If you detect any obvious damage to the product, do not proceed with the installation. Please contact our authorized service center immediately.
- Avoid placing gypsum powder, construction dust, etc. within close proximity of the range hood.
- Operate the range hood only in the manner outlined in this product manual.
- When operating the range hood, do not leave the appliance unattended. If you have any questions and/or concerns, please contact our authorized service center.
- Operate, clean and maintain the range hood in accordance to the instructions outlined in this manual.
- Clean the metal grease filter according to the instructions.
- The range hood's motor has a thermal overload function, which automatically turns off the motor when it overheats. Once the motor cools down, the range hood will automatically restart. If the motor, continually turns off and restarts, please contact our authorized service center.
- If the range hood has not been in operation for an extended period of time, unplug the appliance.
- Please make sure correct installation and

maintenance of the appliance. Installation work and electrical wiring must be done by qualified person(s), in accordance with all applicable codes and standards, including fire-rated construction codes and standards. The installation personnel should be responsible for normal operation of the appliance at the installed position.

- When operating the range hood in exhaust mode, ensure to install the damper along with the hood.
- For general exhausting only. Do not use this range hood to exhaust hazardous and /or explosive materials or gas.
- In order to reduce the risk of fire, all exhaust pipes, flues and devices should be nonflammable. Use only metal duct cover and metal duct pipes. Never cover the hood with flammable plastic film or paper.
- Services guaranteed under warranty must be performed by Fotile certified service provider or personnel.
- Please read the specification label on the range hood for further information and requirements.

Caution:

- When applicable local regulations comprise more restrictive installation and/or certification requirements, the aforementioned requirements will prevail, and installation personnel must conform to these requirements.
- The operating temperature of the range hood should not exceed 104 °F (40°C).
- Please do not place anything on top of the product. Anything placed on top may fall off or incline. For example, if you place seasoning bottles on top, the inclination may cause liquid to flow inside the product, resulting in damaged electrified components and therefore unnecessary risks. Our company will not bear the responsibility for free repair in case of product damage due to the above reason.
- Clean the Grease Cup frequently to prevent overflow. The resulting grease is inedible!
- When cutting or drilling into the wall or ceiling,

be careful not to damage electrical wiring, water pipes, gas lines, or other hidden utilities.

- Adhere to the heating equipment manufacturer's guidelines and safety standards, such as those published by the National Fire Protection Association (NFPA), the American Society for Heating, Refrigeration and Air Conditioning Engineers (ASHRAE) and the local code authorities. Meanwhile, conform to the safety standards issued by such administrative departments as fire department.
- When gas burners are in operation without any cookware placed on them, they can build up a lot of heat. A ventilation appliance installed above the cooker may become damaged or catch fire. Only operate the gas burners with cookware on them.
- Adhere to the voltage and frequency settings listed in this manual to avoid possible damages to the range hood.
- Please use standard accessories provided by our company to prevent the range hood from falling down accidentally. The hole drilled in the wall should precisely match the size of the expansion pipe, otherwise, the range hood may loose and fall down.
- Tampered glass is applied to the products of the company and the tampering treatment of the glass determines the extremely little possibility of spontaneous explosion. If the occurrence of spontaneous explosion is not due to improper use, our company promises free replacement of the accessories.

Warning:

Risk of Electric Shock

A defective appliance may cause electric shock. Never switch on a defective appliance. Unplug the appliance from the mains or switch off the circuit breaker in the fuse box in case of problems, and contact our authorized service center.

- The range hood should be connected to a standard power socket with safe grounding. Midway connection, prolonged electric line or multi-socket wiring may cause electric shock,

overheating and, in some cases, result in a fire. Installation of the range hood should be performed by professional electricians in strict accordance with electricity standards and regulations of the local area. Before connecting the rod, turn off the power source and take appropriate measures to prevent auto closing of the power switch.

- In order to prevent electric shock and/or other bodily injuries to persons, do not exceed 120V AC input.
- Do not install the range hood in a bathroom and/or a humid area, as this will significantly increase the risk of electric shock.
- If a wire is damaged or defective, contact an authorized service provider or a qualified technician (provided by Fotile) to replace the wire.
- Do not change, stretch, knot, pressure or squeeze the wire as any resulting damage can result in electrical and/or fire hazards.
- Prevent water from coming into contact with the range hood's electrical components, such as the motor, switch and connector. Do not wash the appliance with water. Do not use the appliance if it is wet, as electric leakage and/or electric shock may occur.
- Do not attempt to change the range hood's internal wiring system. Improper modifications and/or repairs to the internal wiring can result in bodily injuries to persons, electric shock and/or a fire.
- In order to avoid electric shock, remember to turn off the appliance's power source before installation, cleaning and/or maintenance service.
- Avoid using high-pressure detergents and/or steam cleaners on the appliance, as they may result in electric shock.
- Do not touch the plug or switch with wet hands, as an electric shock may occur.

Grounding Instructions

- This appliance must be grounded. In the event of an electrical short circuit, grounding reduces the risk of electric shock by providing an escape

wire for the electric current. This appliance is equipped with a cord having a grounding wire with a grounding plug. The plug must be plugged into an outlet that is properly installed and grounded.

- Improper grounding can result in electric shock.
- Consult a qualified electrician if the grounding instructions are not completely understood, or if doubt exists as to whether the appliance is properly grounded.
- Do not use an extension cord. If the power supply cord is too short, have a qualified electrician install an outlet near the appliance.

Risk of Fire

- In order to reduce the risk of fire and to properly exhaust air, always duct the air outside. Do not vent exhaust air into spaces within walls, ceilings, attics, crawl spaces and/or garages.
- In order to prevent the risk of fire, the range hood should be operated and maintained in accordance to the instructions.
- Hot oils may ignite and burn quickly. Never leave hot oils unattended.
- Clean the hood's Grease Cup at regular intervals, as leftover grease deposits may ignite.
- Never operate the range hood without the Grease Cup filter attachment.
- Never work with naked flames close to the appliance (e.g. flambéing). Do not install the appliance near a heat-producing appliance for solid fuel (e.g. wood or coal) .There must be no flying sparks.
- Avoid cooking with food products that produce flames under the range hood.

To Reduce Risk of Cooktop Grease Fire:

- A) Never leave surface units unattended at high settings. Boilovers cause smoking and greasy spillovers that may ignite. Heat oils slowly on low or medium settings.
- B) Always turn the hood on during cooking.
- C) Clean ventilating fans . Grease should not be allowed to accumulate on fan, filter or in

exhaust ducts.

- D) Use proper pan size. Always use cookware appropriate for the size of the surface element.

To Reduce the Risk of Injury to Persons in the Event of a Range Top Grease Fire, Observe the Following:

- Smother flames with close-fitting lid, cookie sheet, or metal tray, then turn off the burner. Be careful to prevent burns. If the flames do not go out immediately, evacuate and call the fire department.
- When the cooking utensil catches fire, switch off the range hood immediately. Effective extinguishing measures must be taken at once, such as covering the open flame with metal cover, turning off the master gas valve and keeping flammable substance from the open flame etc.)
- Never pick up a flaming pan—you may be burned.
- Do not use water, including wet dishcloths or towels—a violent steam explosion will result.

Use an Extinguisher Only If:

- You know you have a class ABC extinguisher and you already know how to operate it.
- The fire is small and contained in the area where it started.
- The fire department is being called.
- You can fight the fire with your back to an exit

Risk of Injury

- This appliance is not intended for use by persons (including children) with reduced physical, sensory or mental capabilities, or lack of experience and knowledge, unless they have been given supervision or instruction concerning use of the appliance by a person responsible for their safety. Children should be supervised to ensure that they do not play with the appliance.
- The range hood may have sharp edges. Be careful to avoid cuts and abrasions during installation and cleaning. Do wear qualified protective gloves.

- The accessible parts become very hot when in operation. Never touch hot parts. Keep children at a safe distance.
- Do not touch lamps during or soon after operation. Burns may occur.
- Do not insert your limbs and/or foreign objects into the impeller while the range hood is in operation, as that action might cause injury.
- This appliance is not intended for operation with an external clock timer or a remote control.
- Incorrect repairs are dangerous. Repairs may only be carried out and damaged power cables replaced by one of our trained after-sales technicians.
- If any abnormalities and/or defects occur while operating the range hood, immediately turn off the appliance and unplug the appliance from the mains or switch off the circuit breaker in the fuse box. Then, contact our authorized service center. Abnormal operation and defects may cause hazardous situations, such as electric shocks and fires.

Risk of Suffocation:

- Packaging material is dangerous to children. Never allow children to play with packaging material, which may cause suffocation. Keep all packing material out of proximity to children. Please remember that packaging materials should not be treated as toys.

Risk of Death:

- Risk of poisoning from flue gases that are drawn back in.
- Always ensure adequate fresh air in the room if the appliance is being operated in exhaust air mode at the same time as room air-dependent heat-producing appliance is being operated. Exhaust gases through the flue (chimney) of fuel burning equipment to prevent back drafting.
- Fotile is not responsible for injuries caused by improper and/or incorrect operation of the range hood.

OPERATION

Warning

1. Do not use excessive force to press buttons on the control panel.
2. Turn off gas burners without any cookware placed on them.
3. Do not disassemble the appliance with power on and/or without complying with instructions.
4. Clean the Grease Cup frequently to prevent overflow and a potential fire.
5. Disassembly and/or servicing of the range hood must be performed by qualified technicians.
6. Do not let the stove fire burn the range hood directly.

Product Information

Model	JQG7502/JQG7502.G	
Produce size L*D*H	29 7/8 × 18 1/4 × 17 7/16 " (758 × 462 × 442 mm)	
Net weight	58.2 lbs(26.4 Kg)	
Voltage/Frequency	120V/60Hz	
Rated power input of the range hood	256 W (light power included 3W × 2)	
Noise	high setting	68dB(A)(5.4Sones)
	medium setting	63dB(A)(3.5Sones)
	low setting	53dB(A)(1Sones)
Max static pressure	380 Pa	
Caution: 1. The dB(A) noise in the above table is tested in accordance with IEC60704 standard, which indicates the sound power level. Pressure level, to answer for: High setting 54 dB、medium setting 49 dB、low setting 39 dB. 2. The noise --Sones -- in the above table is tested in accordance with HVI-915-2015 in HVI-accredited laboratories in American. 3. Such parameters as noise may have a deviation of less than 5%.		



HVI-2100 CERTIFIED RATINGS comply with new testing technologies and procedures prescribed by the Home Ventilating Institute, for off-the-shelf products, as they are available to consumers. Product performance is rated at 0.1 in. static pressure, based on tests conducted in a state-of-the-art test laboratory. Sones are a measure of humanly-perceived loudness, based on laboratory measurements.

Operation

1. Fotile Range Hood Control Panel

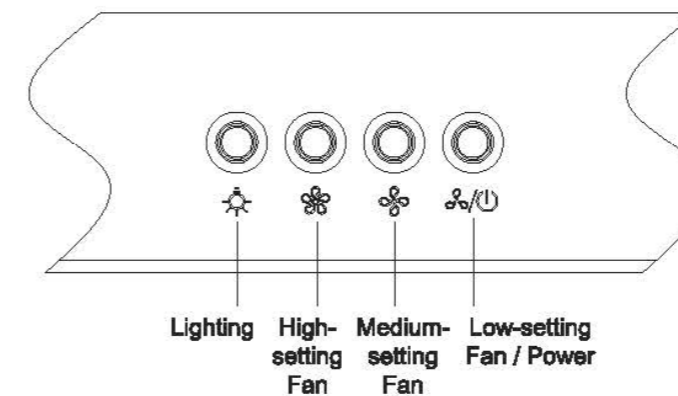

2. Operation Procedure

- (1) Lighting key:
Press the button to turn on the light; press the button again to reset, and the light will be turned off.
- (2) HIGH-SETTING FAN:
Press the " LOW-SETTING FAN/POWER" and " HIGH-SETTING FAN" keys successively, and the hood will run at high gear (Note: Press all the " LOW-SETTING FAN/POWER", " MEDIUM-SETTING FAN" and " HIGH-SETTING FAN" keys, and the hood will still run at high gear); press the " LOW-SETTING FAN/POWER" key again to reset, and the motor will stop running.
- (3) MEDIUM-SETTING FAN:
Press the " LOW-SETTING FAN/POWER" and " MEDIUM-SETTING FAN" keys successively, the hood will run at medium gear; press the " LOW-SETTING FAN/POWER" button to reset, and the motor will stop running.
- (4) LOW-SETTING FAN/POWER:
Press the " LOW-SETTING FAN/POWER" key, and the hood will run at low gear; press the " LOW-SETTING FAN/POWER" key again to reset, and the motor will stop running.

CLEANING AND MAINTENANCE

Important Note:

Reattach the grease filter after cleaning and maintenance of the range hood. Do not operate the appliance without the grease filter, as it may cause safety hazards.

Caution:

Risk of demager due to corrosion.

- Always switch on the appliance while cooking to avoid condensation. Condensate can produce corrosion damage.
- Surface damage due to incorrect cleaning. Clean stainless steel surfaces in the direction of the grain only. Do not use any stainless steel cleaners for operator controls.
- Surface damage due to strong or abrasive cleaning agents.
- Replace faulty LED lights to prevent the remaining lights from overloading.

Warning:

- The range hood should only be cleaned as instructed; otherwise, it may ignite.
- Please remember not to wet the motor and/or the control panel, as it may result in damaging the electric circuits or potential hazards.
- Do not clean the appliance with chemical agents, such as gasoline, acids, benzene and solvents.

Risk of Electric Shock:

- Penetrating moisture may result in an electric shock. Prior to cleaning and maintenance, pull out the mains plug or switch off the circuit breaker in the fuse box.
- Do not use any high-pressure cleaners or steam cleaners, which can result in an electric shock.

Risk of Fire:

Grease deposits in the grease filter and Grease Cup may catch fire.

Risk of Injury:

- Unplug the appliance from the mains or switch off the circuit breaker in the fuse box before installation, cleaning, maintenance and repair in order to avoid electric shock.
- The range hood may have sharp edges. Be careful to avoid cuts and abrasions during installation and cleaning. Do wear qualified protective gloves.
- While the range hood is in operation, do not insert your hand into the area housing the fan.
- The appliance will become hot during operation, especially near LED lights. Allow the appliance to cool down before cleaning. Do not touch lamps during or soon after operation. Burns may occur.
- If you would like to schedule a deep cleaning for your appliance, please contact our authorized service center.
- Fotile suggests that you clean the surface of the appliance for better use.

- 1) Neutral detergent may be used to clean stains on the range hood. However, avoid touching the control panel. Wipe some detergent on the stains and let the detergent sit. Do not let the detergent sit for an extended period of time, as it can cause damages to the appliance's surface. Then, wipe off the stain with a soft cloth and the left detergent with a slightly wet cloth. Next, use another cloth to dry the appliance.
- 2) Stains on the range hood should be cleaned within a short time period, as to prevent the stains from becoming permanent.
- 3) Abrasive detergents, such as a salt solution, disinfectant or bleach powder cannot be used

to clean the appliance. Wipe off the detergent with a wet, soft cloth. Next, use another cloth to dry the appliance.

Warning: Do not clean the appliance with abrasive tools, such as steel wool, brushes, and coarse cloths, as these materials will permanently scratch the surface of the hood.

Preparations before Cleaning:

1. Unplug the appliance.

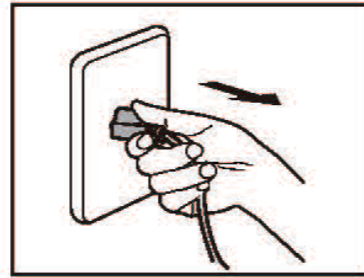

2. Clear the cookware on the burners.
3. Prepare a neutral detergent and a soft cloth (or soft brush) for stain removal and cleaning.

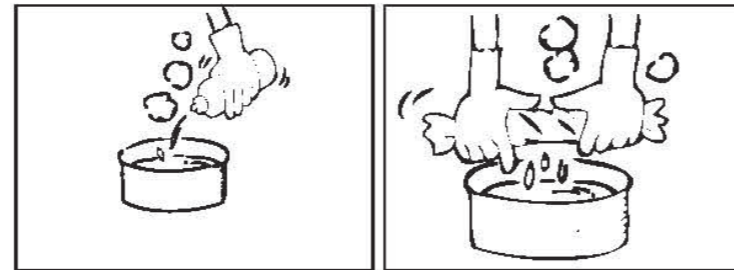

**Washing and cleaning the surface, Grease Cup, and grease filter:
(The cleaning can be done by the user)**

1. Clean the surface of the hood and the back of the smoke baffle plate.

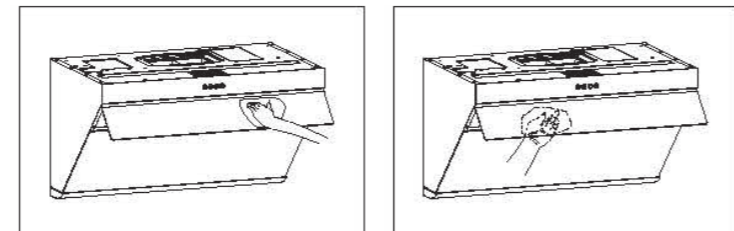

2. Remove the oil cup horizontally and clean it.

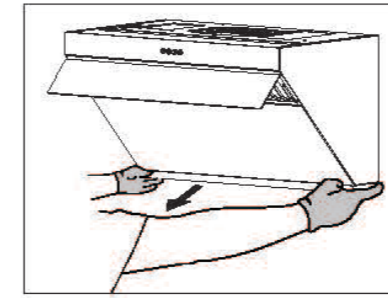

Warning: For the safety of you and your family, please regularly clean the oil accumulated in the Grease Cup and deposits on the Grease Cup surface. Do wear qualified protective gloves.

3. Hold the two sides of the grease filter and pull sideward to unlock it.

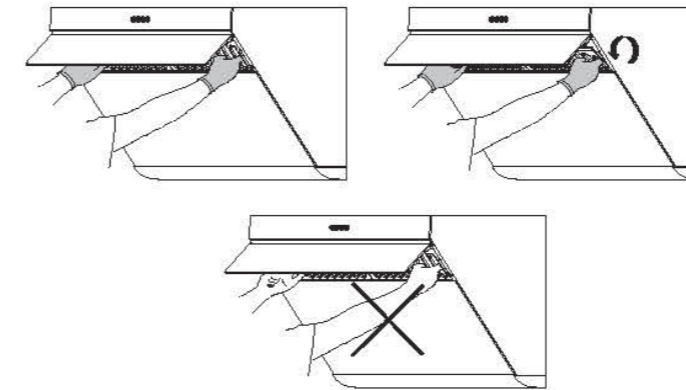

★ **Suggestion:** In order to protect the health of you and your family, the filter should be cleaned regularly and it is dishwasher safe for your convenience.

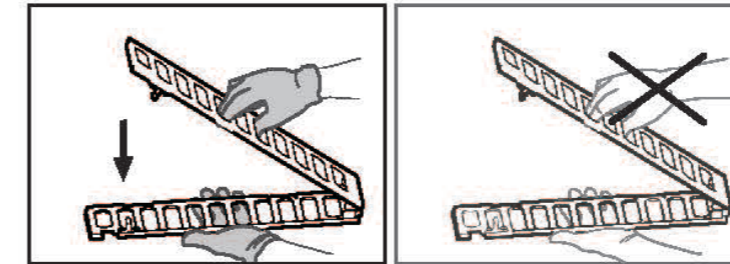

Warning: Please wear the qualified protective gloves in operation.

Replacing LED Lights:

1. Unplug the appliance.

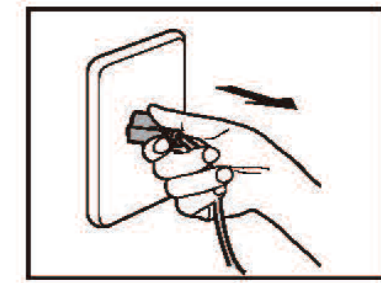

2. Use a small flat-head screwdriver to gently pry the LED assembly out.

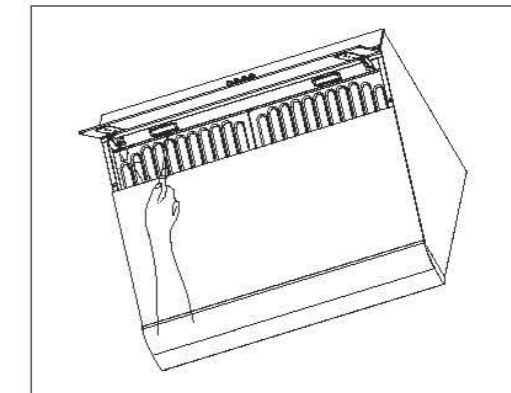

3. Disconnect the wires and then replace the LED lights.

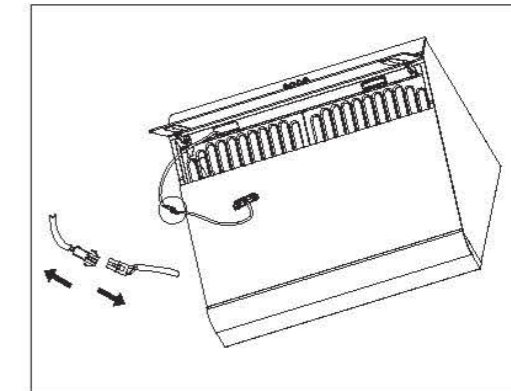

Risk of Electric Shock:

Before changing the LED lights, unplug the appliance from the mains or switch off the circuit breaker in the fuse box.

FAQ

Warning: Risk of Electric Shock

- Incorrect repairs are dangerous. Repairs may only be carried out and damaged power cables replaced by our authorized service center, or certified electricians.
- If the appliance is defective, unplug the appliance from the mains or switch off the circuit breaker in the fuse box. Contact our authorized service center.
- Before changing LED lights, unplug the appliance from the mains or switch off the circuit breaker in the fuse box.
- If any abnormalities and/or defects occur while operating the range hood, immediately turn off the appliance. Unplug the appliance from the mains or switch off the circuit breaker in the fuse box and check the following:

Problem/Issue	Possible Cause
After the POWER button is pressed, the range hood remains off and the button does not illuminate.	The appliance may be unplugged
The motor works, but the control panel buttons do not illuminate.	LED lights have been damaged

If the problem/issue with the appliance still persists after ruling out the possible cause(s), please contact our authorized service center for assistance.

SERVICE INFORMATION

Warning

- If any abnormalities and/or defects occur while operating the range hood, immediately turn off the appliance. Unplug the appliance from the mains or switch off the circuit breaker in the fuse box. Please contact our authorized service center.
- The appliance must only be repaired by professionally trained and certified technician; otherwise, severe injuries may occur.
- Warranty service is not provided based on the following situations:
 - 1) Failing to show invoice issued by authorized agents.
 - 2) Damages of the parts due to the abused and wrong installation, improper use, improper location, carelessness or other factors.
 - 3) Repair and maintenance without the permission of FOTILE authorized agents.
 - 4) Other situations that can't be controlled by FOTILE authorized agents.

In above case, FOTILE will be released from any responsibilities for the loss of personal property, personal injury directly or indirectly caused by the product.

INSTALLATION

6.1 Installation Instructions

Important Note:

- Prior to installation, please read the Fotile Range Hood Installation carefully and save it for the local inspector's future reference.
- This appliance must be installed in accordance with National Electrical Codes, as well as all state, municipal and local codes.
- The appliance must be equipped with safe circuit breaker and installed with safe grounding.
- The correct voltage, frequency and amperage must be supplied to the appliance according to the proper voltage, frequency and amperage ratings listed on the product rating plate.

- This installation must be completed by Fotile authorized service center, or certified installers.
- Please record the model and serial number before installing the range hood. Both numbers are listed on the product rating plate, located on the upper wall of the hood. Refer to the illustration below.

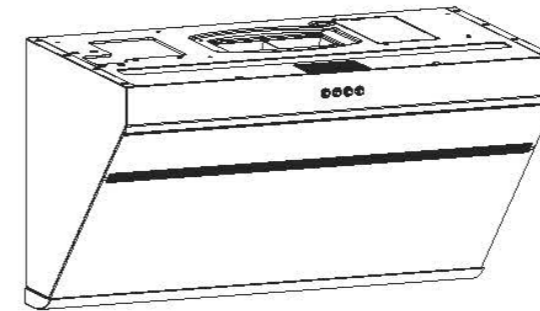

Caution:

- Please carefully read all instructions prior to installation. Please give special consideration to the following items:
 1. If you are renovating your kitchen, be careful to not expose the exterior of the range hood. Building materials, dust, paint, coating, and gases will corrode and tarnish the surface of the range hood. It is recommended that you install the range hood after all renovations are completed.
 2. If you need to remove your gas burner before installation, please turn off the main gas valve first.
 3. Do not connect the range hood duct to a duct used to exhaust hot air or fumes from another appliance.
 4. Two installers are recommended due to the large size and heavy weight of the range hood. Since the installation is complex and the appliance is heavy, professional installers are required to install the appliance as outlined in this manual.
 5. After the appliance fixed, the plug should be accessible.
 6. Make sure to keep the appliance horizontally.
 7. Ensure that the appliance functions normally after the installation is complete.

Warning:

- In order to reduce the risk of fire, electric shock, or injury to persons, please carefully read the following:
 1. The installation and wiring of the appliance should only be carried out by a professional electrician in accordance with current national or local electric safety regulations, including fire-rated construction. Non-professional personnel should not conduct installation. Proper installation is the responsibility of the installer. Product failure due to improper installation is not covered under the Fotile warranty.
 2. Please use standard installation equipment and tools provided by Fotile to ensure safe installation. Make sure to use the expansion tube and expansion bolt provided by our company, in case the range hood falls down accidentally. The hole drilled into the wall should precisely match the size of the expansion tube, otherwise the range hood will not be properly secured to the wall and may fall down.
 3. The range hood should be connected to a standard power socket with safe grounding. The midway connection, prolonged electric line or multi-socket wiring may cause electric shock, overheating and even fire. Power off before wiring and make sure proper measures have been taken to avoid unexpected connection.
 4. During installation, switch off the circuit breaker in the fuse box during installation. If the supply cord is damaged, it must be replaced by a special cord or assembly available from the manufacturer or its service agent.
 5. The appliance should only be installed, removed and maintained by qualified technicians to prevent risks like electric shocks, falling or fires from occurring.

Risk of Injury:

- Unplug the appliance from the mains or switch off the circuit breaker in the fuse box before installation, cleaning, maintenance and repair in order to avoid electric shock.
- The range hood may have sharp edges. Be careful to avoid cuts and abrasions during installation and cleaning. Do wear qualified protective gloves.

Warning Before Installation

- Prior to installation, ensure that the exhaust outlet is free of debris, as they may damage the range hood.
- A straight and short ducting run will ensure a high performance of the range hood.
- A curving and long ducting run should be avoided, as it will lower the performance of the range hood.
- Strictly seal the connection between the duct and duct hole with duct tape. Ensure that the connection between the duct and the duct cover is secure, and seal it with aluminum tape.
- A small duct hole will lower the performance of the range hood. Therefore, it is highly recommended that you cut a duct hole equal to or larger than 6" of the size.

6.2 Product Dimensions

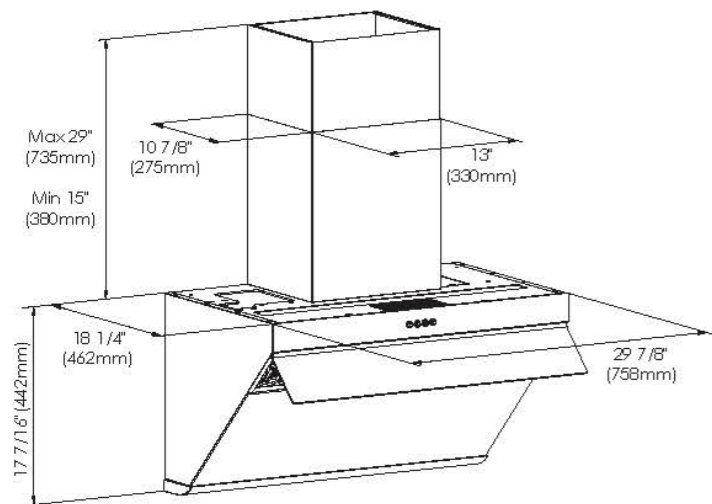

Wall Preparation

The wall should be strong enough to support the range hood. As for hollow wall or hollow plate, The minimum thickness of the lumber should be 13/16" (30mm). As for concrete wall, the installation can be directly operated. The range hood should be firmly fixed on the wall.

Ductwork Installation

Risk of Injury:

- Unplug the appliance from the mains or switch off the circuit breaker in the fuse box before installation, cleaning, maintenance and repair in order to avoid electric shock.
- The range hood may have sharp edges. Be careful to avoid cuts and abrasions during installation and cleaning. Do wear qualified protective gloves.
- When cutting or drilling into walls or ceilings, do not damage electrical wiring and other hidden utilities.
- Ducted fans must always be vented to the outdoors.
- To reduce the risk of fire and to properly exhaust air, always duct air outside. Do not vent exhaust air into spaces within walls, ceilings, into attics, crawl spaces or garages.

6.3 List of Accessories:

Packing List

Standard Configuration	
Product	1
Duct Cover	1
Gasket	1
Grease Cup	1
Product Manual	1
Installation Paper Template	1
Warranty Card	1
Duct Bracket	1
Bracket Screws ST5 x 65	5
Expansion Tubes φ8 x 50	5
Duct Cover Screws M4 x 18	4
Upper Plate Fastening Screws M5 x 70	3
Fixing screws of the smoke baffle plate M4x8	2 (keep another screw for backup)
Collision Avoidance Elements	2

Housing Assembly Accessories (optional)	
Blower Housing	1
Decorative Cover	1
Decorative Cover Bracket	1
Safety Buffer Baffle	1
Duct Cover Screws M4 x 10	4
Base	2
Base Screws M4 x 8	2
Bracket Screws ST5 x 65	3
Expansion Tubes φ8 x 50	3
Screws ST2.9 x 19	2
Decorative Plate Assembly Accessories (with upper cabinet)	
6" or 12" Decorative Plate	1
Fixed Decorative Plate Screws ST3.5 x 35	4
Base	2
Base Screws M4 x 8	2

6.4 Installation Tools:

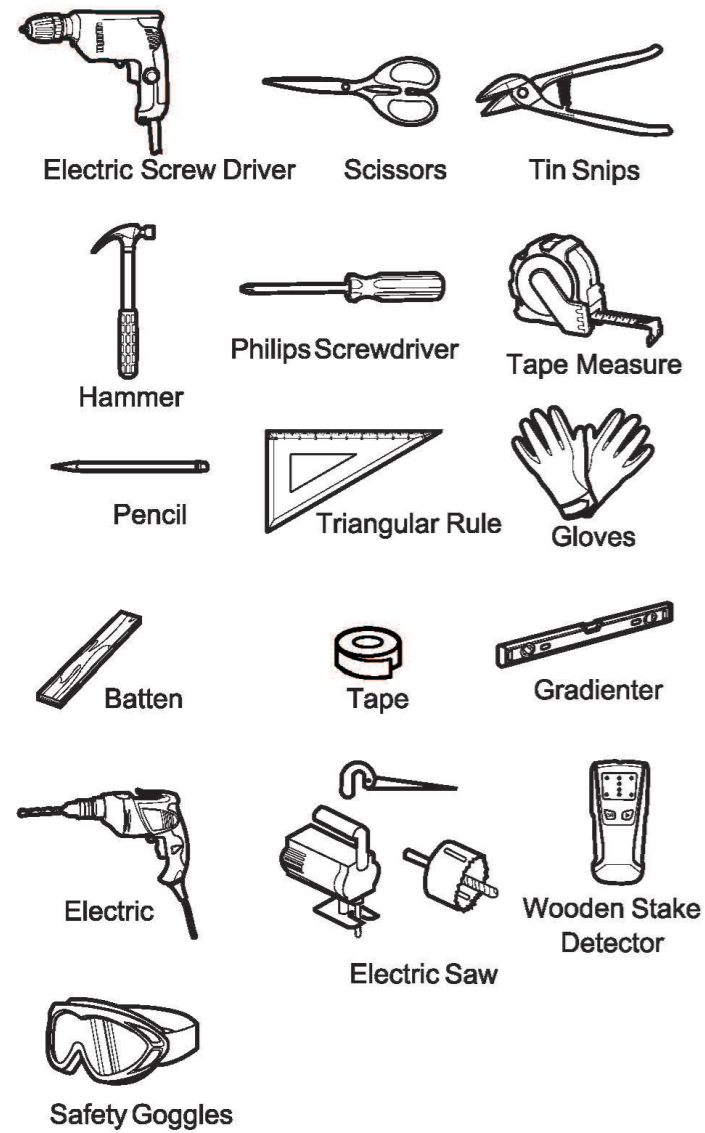

6.5 Installation Procedure:

In order to secure the safe use of the range hood and maximize its ability to ventilate cooking fumes, the installation height is suggested as follows: The distance from the countertop of the gas stove to the top board of the range hood shall not be less than 29 9/16" (750mm) and shall not be more than 32 1/2" (825mm). Where there are relevant laws stipulating the mounting height of range hood in the state or region, the laws shall prevail. However, the effect of cooking fumes ventilation might be affected. The range hood can be installed in three ways, either with or without the upper cabinet.

Caution: One of the screws for duct bracket must be fastened to the wooden beam.

Installation of the Fotile Range Hood with an Upper Cabinet:

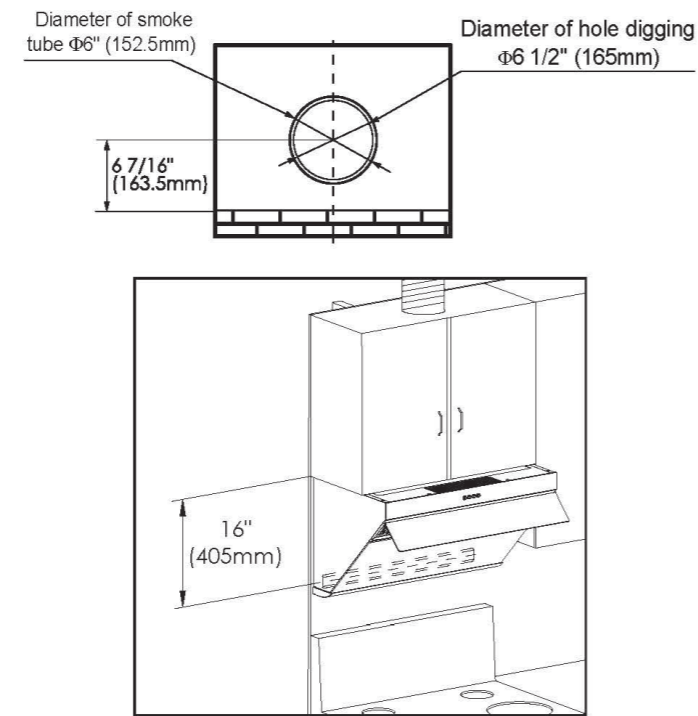

Warning: Do wear qualified protective gloves.

1. Unpack the appliance and check the List of Accessories.

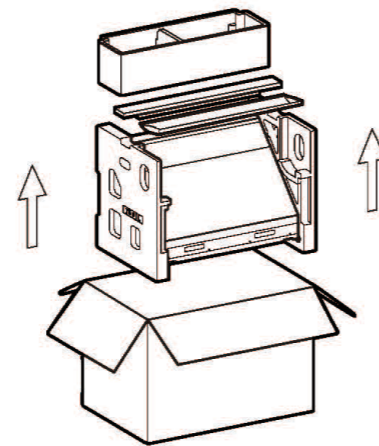

2. Locate the wooden beam and mark the location with a pencil. Mark another beam 16" (405.4mm) or 24" (609.6mm) to either side of this mark.

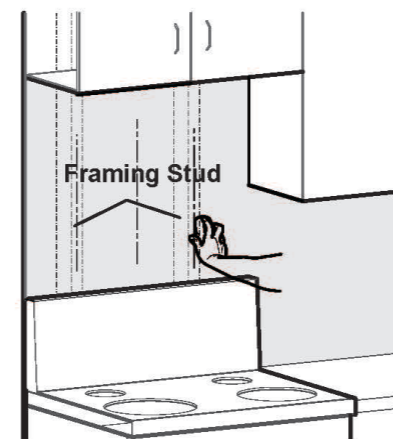

3. Locate the duct bracket. Determine the central point and mark the centerline on the wall where the hood will be installed. Also, mark the point where the central line and the lowest point on the bottom board of the top cabinet meet. This is the location, in which to secure the bracket. Mark screw hole locations on the wall. The distance between the lowest point on bottom board of the top cabinet and the center of the bracket should be 16" (405mm).

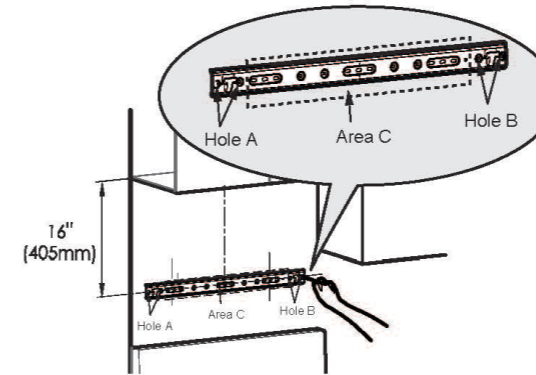

4. Fasten the bracket: drill $\phi 3/8"$ ($\phi 8$) hole at the screw hole marks with electric drill, embed expansion tubes and fasten the bracket with bracket screws. Use leveling instrument to make sure that the bracket is leveled.

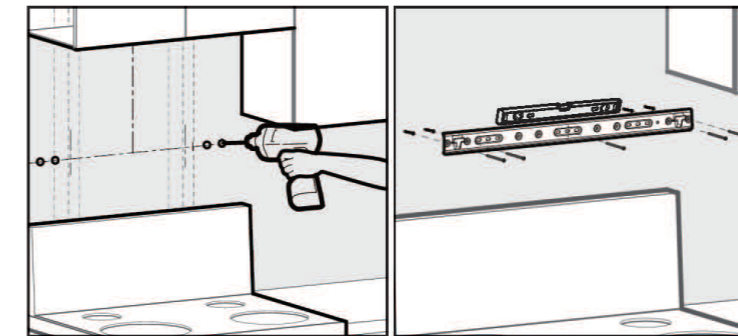

Caution: One of the brackets for main engine must be fastened to the beam. Screws must be fixed at Hole A and B in the drawing; also screws must be fixed at bracket bores with corresponding wooden stakes in Area C.

5. Attach the paper template onto the bottom of the cabinet to determine and drill the duct cover hole, screw holes, and wire hole.

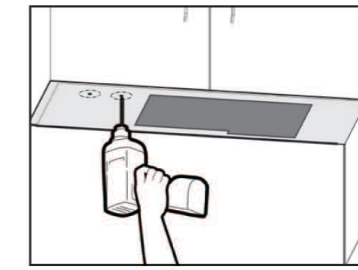
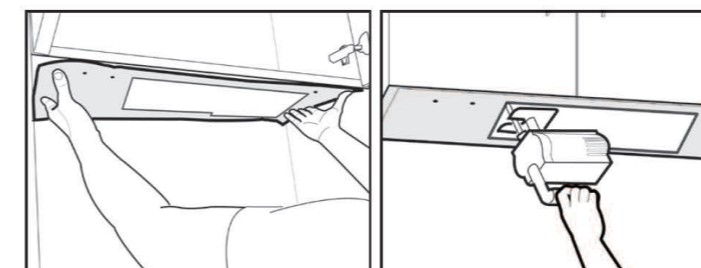

Caution: Wear safety goggles when drilling. In case of batten at the wall facing the bottom plate, the rear wall side of the paper template shall be cut as per the thickness of the batten. In the case that hooks are fixed on tiles, the installation paper on the side of Rear Wall shall be pasted on the bottom of the upper cupboards based on the tile surface.

6. Remove the protective film of the stainless steel surface and Grease Cup at both sides of the range hood.

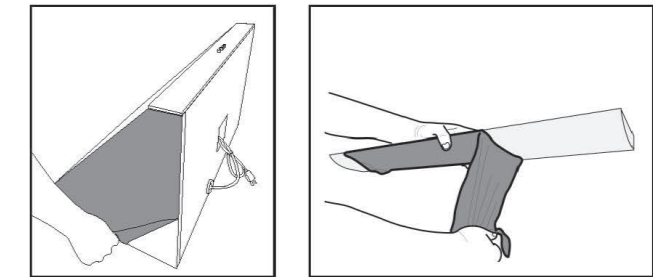

7. Lift and position the hood onto the brackets at the bottom of the backside while keeping an angle between the wall and the hood, and then push the hood against the wall tightly.

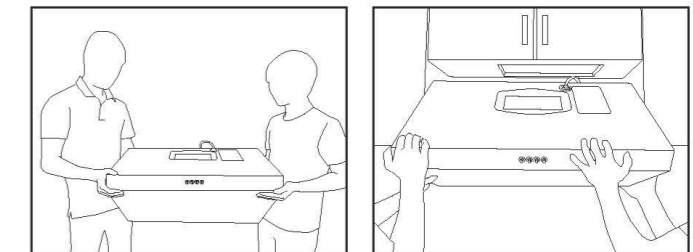

8. Secure the hood to the upper cabinet with three M5 X 70 fastened screws for upper cabinet. The hood will need to be supported before you loose your hands until at least two screws are tightened.

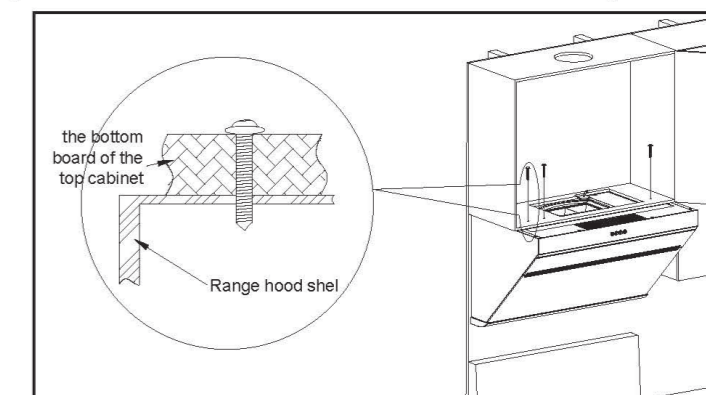

If there is a big gap between the bottom board of the top cabinet and the top of the range hood, please add wood pads based on the gap size near the three M5×70 screws to avoid range hood shell deformation caused by the tightening of screws, which will affect the use of the range hood.

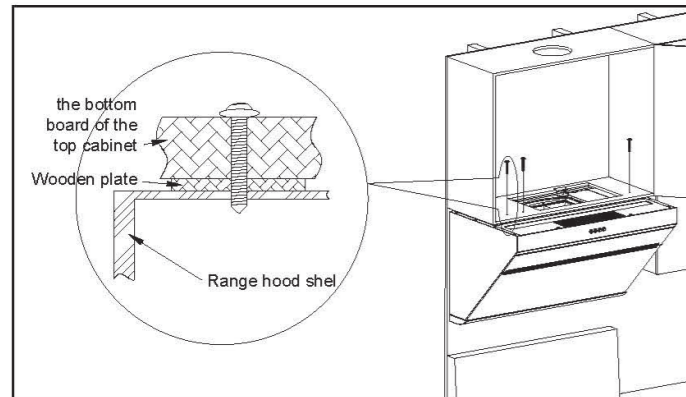

Caution: Two installers are required to ensure safe installation.

9. Place the gasket seal on the hood outlet and fix the duct cover with four screws of outlet housing. Then, secure the duct to the duct cover and seal the connection with aluminum tape.

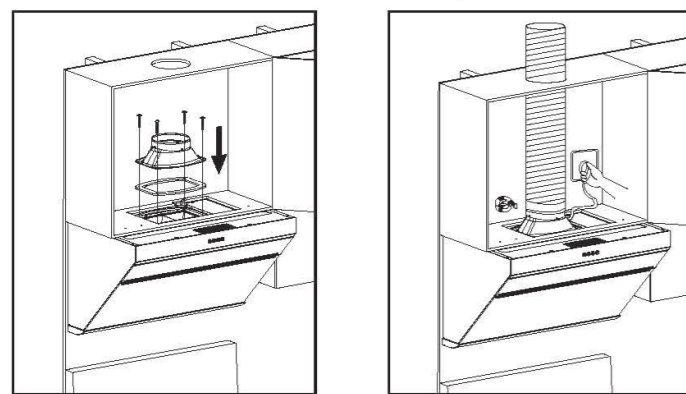

10. Install the smoke baffle plate.

- ① Remove the "Installation Tips" on the smoke baffle plate;
- ② Take out one screw in the accessory bag (keep another screw for backup);
- ③ Open the Smoke Baffle Plate to the maximum angle;
- ④ Fix the left bracket with the screwdriver and screw;
- ⑤ Install Collision Avoidance Elements on both left and right corners of the Smoke Baffle Plate.

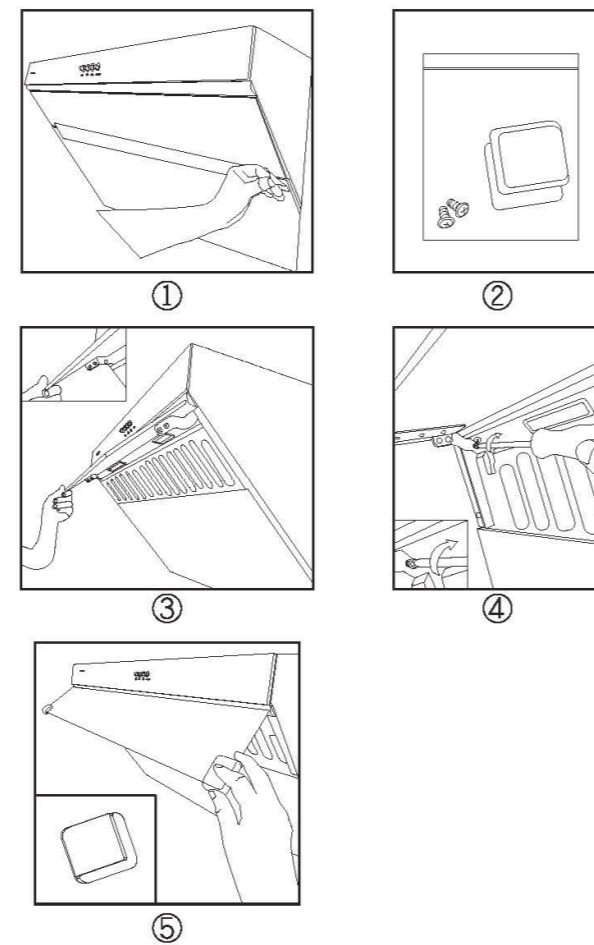

11. Make sure the hood is leveled. Install the Grease Cup, and plug in the appliance for a test run.

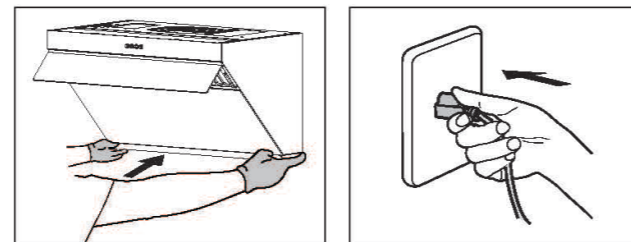

Warning: Please wear the qualified protective gloves in operation.

Installation Instructions for the Decorative Plate with Upper Cabinet :

Caution: Please confirm the height of the top cabinet. If the upper cabinet is over 32 1/2" (825mm) high, 6" or 12" decorative plate is preferred.

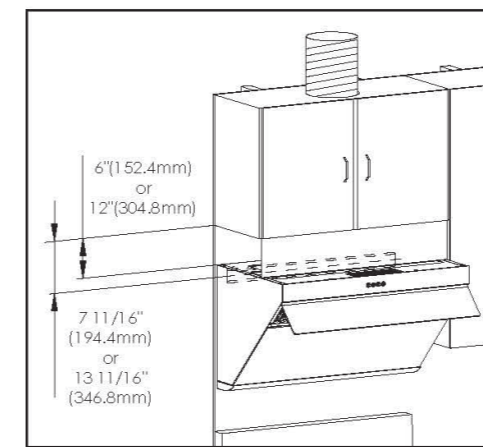
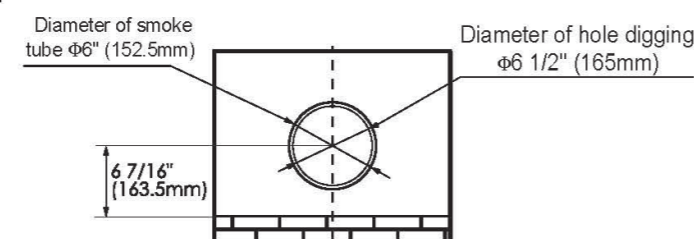

1. Unpack the appliance and check the List of Accessories.

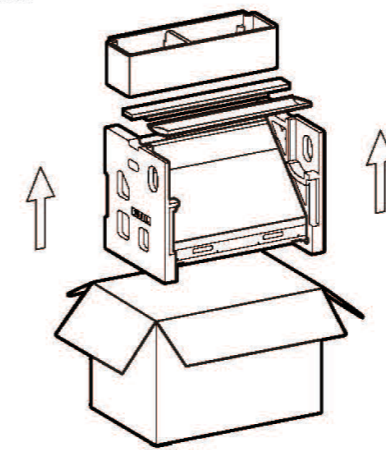

2. Locate the wooden beam and mark the location with a pencil. Mark another beam 16" or 24" to either side of this mark.

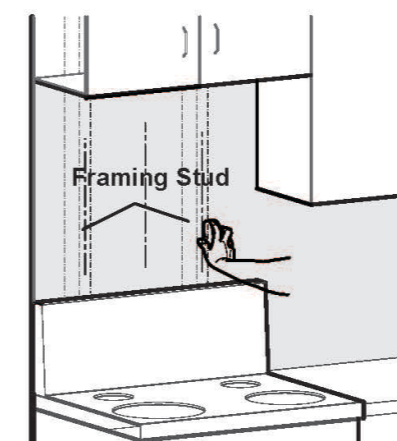

3. Locate the duct bracket. Determine the central point and mark the centerline on the wall where the hood will be installed. Also, mark the point where the central line and the top cabinet meet. This is the location, in which to secure the bracket. Mark screw hole locations on the wall. The upper edge (the fixed surface between the decorative sheet and the board of the top cabinet) of the bottom board of the top cabinet shall be deemed as the location datum. And the distance between the upper edge and the

center of the bracket shall be 7 11/16"/194.4mm for 6" decorative sheet and 13 11/16"/ 346.8mm for 12" decorative sheet.

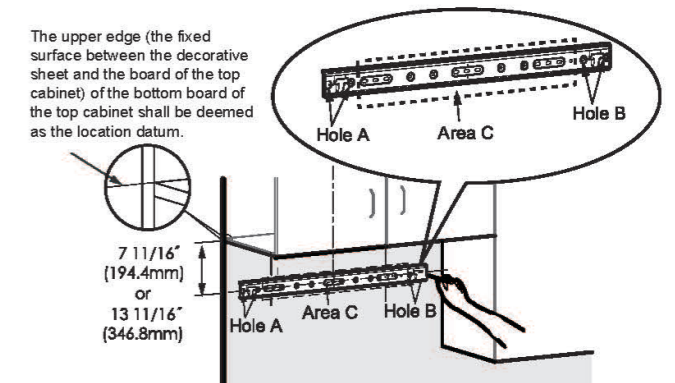

4. Fasten the bracket: drill Ø8 hole at the screw hole marks with electric drill, embed expansion tubes and fasten the bracket with bracket screws. Use leveling instrument to make sure that the bracket is leveled.

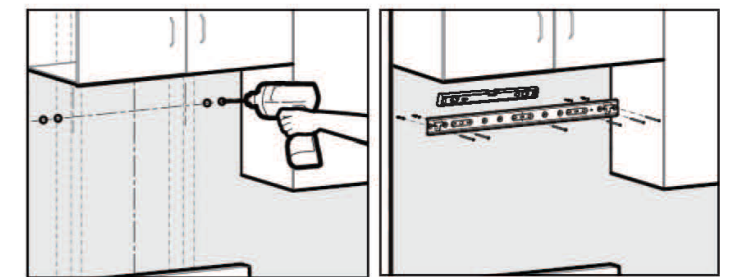

Caution: One of the brackets for main engine must be fastened to the beam. Screws must be fixed at Hole A and B in the drawing; also screws must be fixed at bracket bores with corresponding wooden stakes in Area C.

5. Attach the paper template onto the bottom of the cabinet to determine and drill the duct cover hole, screw holes, and wire hole.

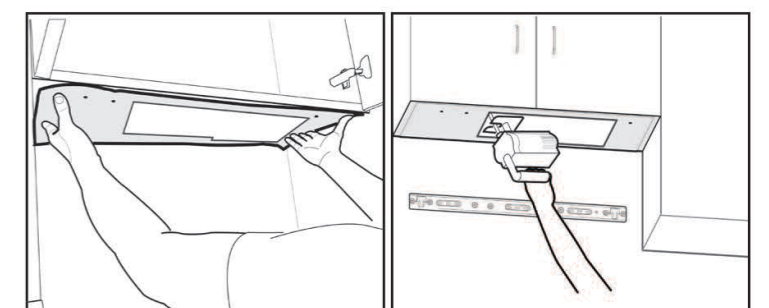

Caution: Wear safety goggles when drilling. In case of batten at the wall facing the bottom plate, the rear wall side of the paper template shall be cut as per the thickness of the batten.

6. Remove the protective film of the stainless steel surface and Grease Cup at both sides of the range hood.

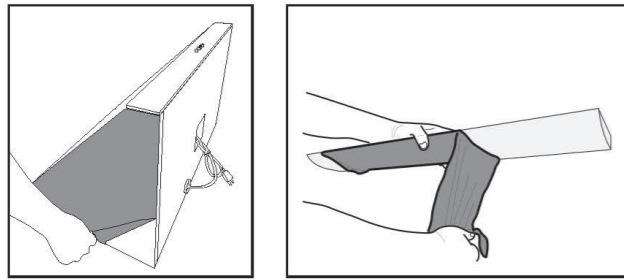

7. Place the gasket seal on the hood outlet and fix the duct cover with four M4 x 18 screws of outlet housing. Use two M4 x 8 base screws to fix the base in the corresponding location at the bottom of the backside of the main engine.

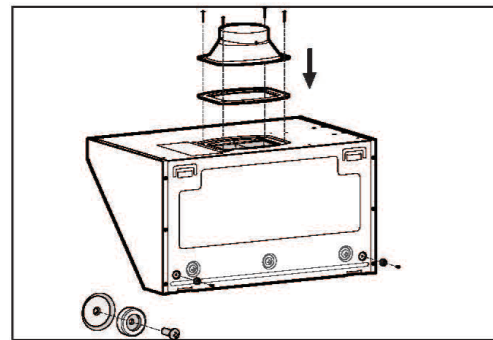

8. Lift and position the hood onto the brackets at the top of the backside while keeping an angle between the wall and the hood, and then push the hood against the wall tightly. Secure the duct to the duct cover and seal the connection with aluminum tape.

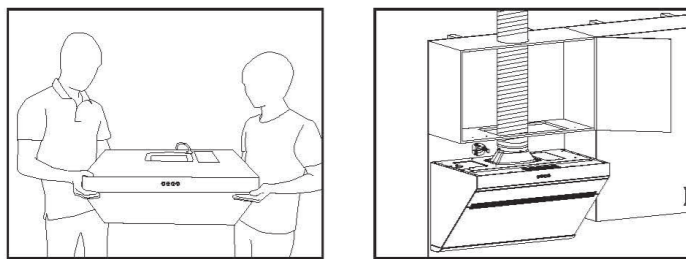

Caution: Two installers are required to ensure safe installation.

9. Install the decorative plate.

Use four 3.5 x 35 wood screws to fix the decorative plate on to the upper cabinet.

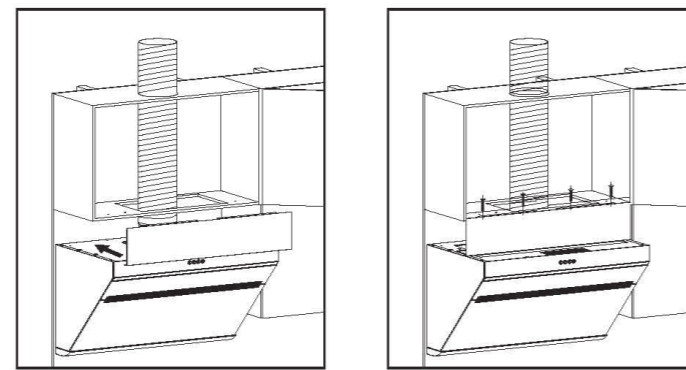

10. Install the smoke baffle plate.

- ① Remove the "Installation Tips" on the smoke baffle plate;
- ② Take out one screw in the accessory bag (keep another screw for backup);
- ③ Open the Smoke Baffle Plate to the maximum angle;
- ④ Fix the left bracket with the screwdriver and screw;
- ⑤ Install Collision Avoidance Elements on both left and right corners of the Smoke Baffle Plate.

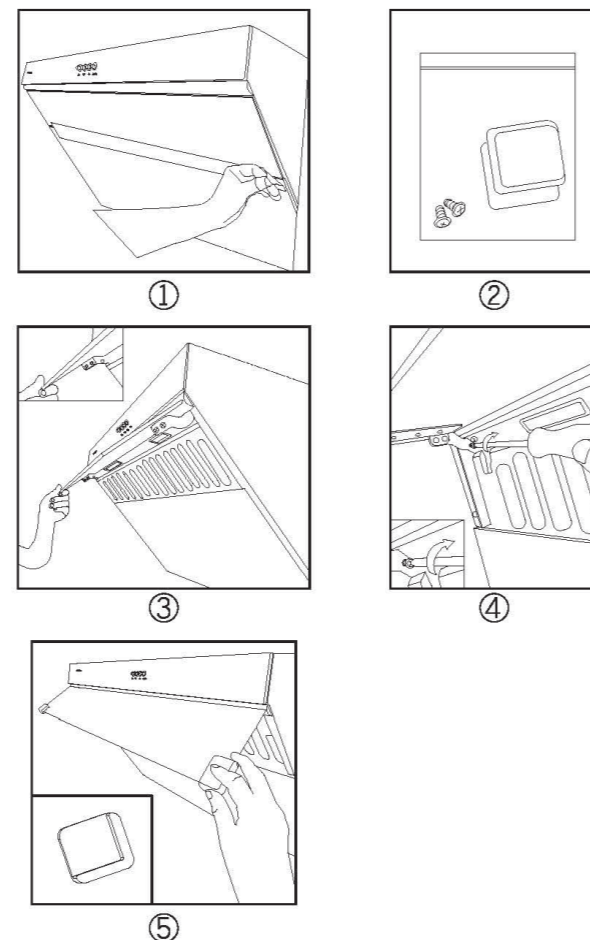

11. Make sure the hood is leveled. Install the Grease Cup, and plug in the appliance for a test run.

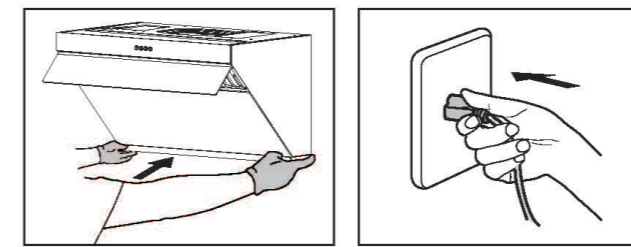

Warning: Please wear the qualified protective gloves in operation.

Installation Instructions for the Decorative Cover Without Upper Cabinet

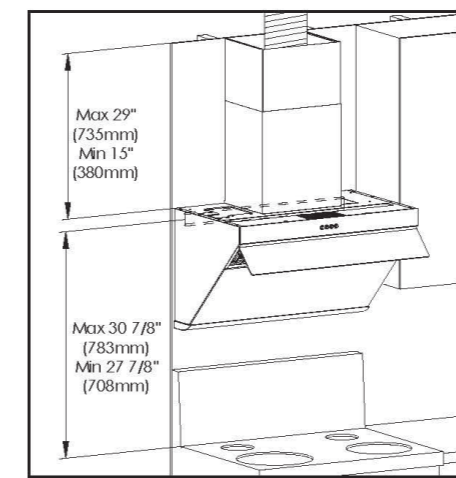
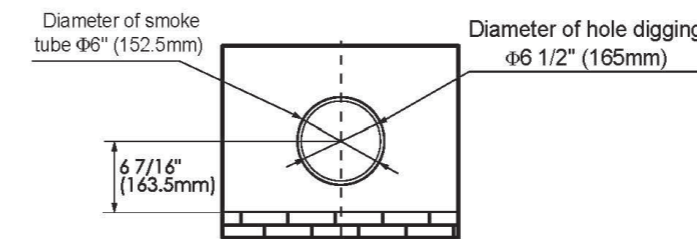

1. Unpack the appliance and check the List of Accessories.

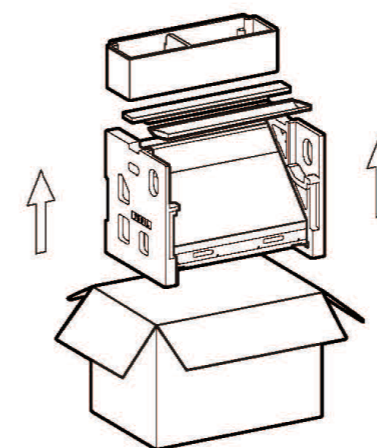

2. Locate the wooden beam and mark the location with a pencil. Mark another beam 16" or 24" to either side of this mark.

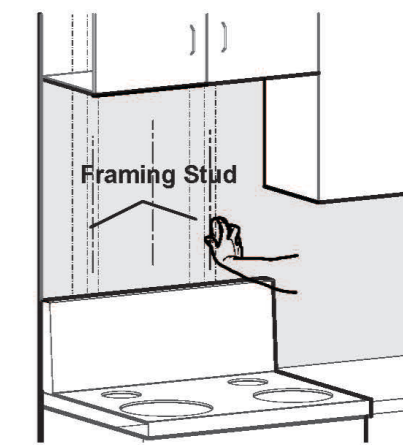

3. Locate the duct bracket, safety buffer baffle and decorative cover bracket:

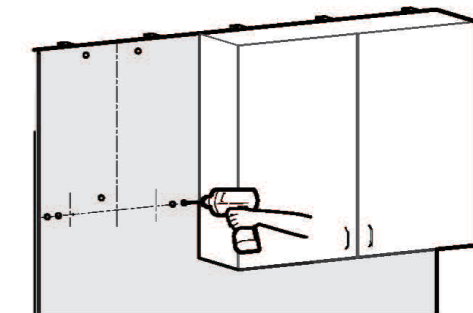
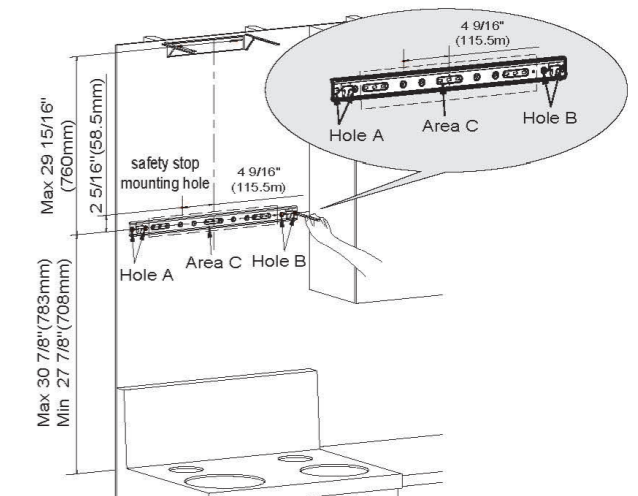

Caution: one of the brackets for main engine must be fastened to the beam. Screws must be fixed at hole A and B in the drawing; also screws must be fixed at bracket bores with corresponding wooden stakes in area C.

Firstly determine the installation central point of the range hood according to the central point of the cooker, determine the bracket installation location based on cooker table and mark the place for drilling. The cooker table is about 27 7/8" (708 mm) to 30 7/8" (783 mm) away from the central point of bracket;

The location to install the safety buffer baffle should be 4 9/16" (115.5 mm) to the left of the duct bracket and 2 5/16" (58.5 mm) straight up.

The location to install the decorative cover bracket should generally be 29 15/16" (760 mm) above the central point of the duct bracket. If the distance between the ceiling and duct bracket equals to or is less than the value, secure the decorative cover bracket on the wall right under the ceiling. If the distance is more than the value, taller decorative covers (27 9/16" (700 mm) and 35 7/16" (900 mm) in height respectively) need to be bought separately.

Drill Ø8 hole at the screw hole marks with electric drill and embed expansion tubes.

4. Secure the duct bracket and decorative cover bracket to the wall with corresponding screws and tighten the screws. Make sure the bracket is leveled.

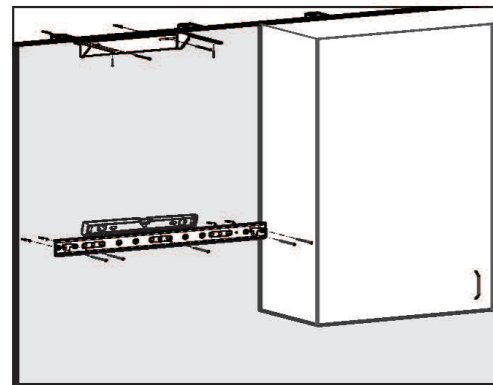

Caution: One of the screws for duct bracket must be fastened to the wooden beam.

5. Fasten the gasket seal and duct cover to the range hood outlet with four M4 x 18 screws and set four cover screws at the corresponding places. Fix two bases at corresponding positions on the back of the range hood with base screws.

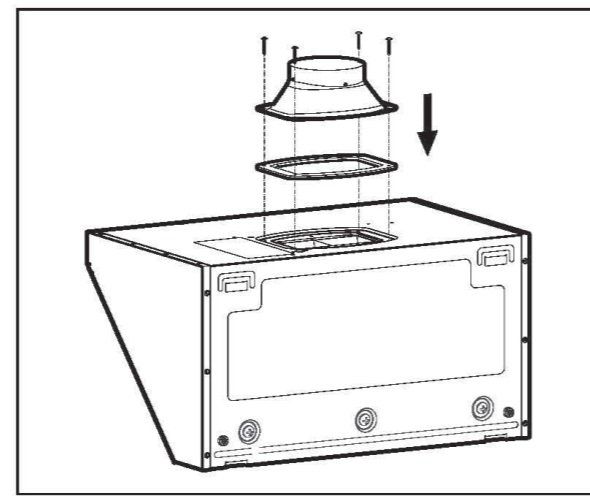
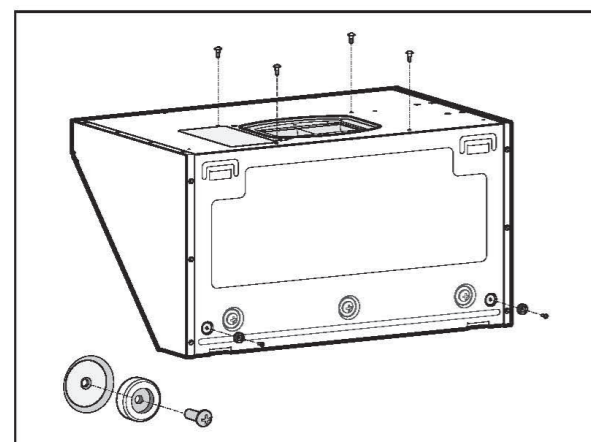

6. Remove the protective film of the stainless steel surface and Grease Cup at both sides of the range hood.

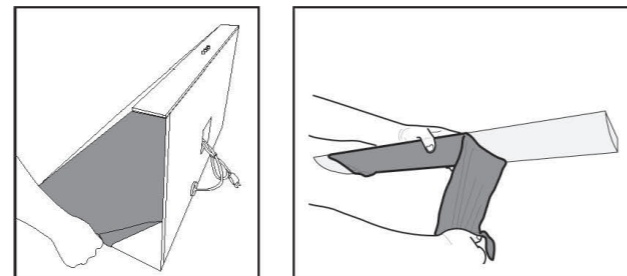

7. Lift and position the hood onto the mounting screws. Make sure the hood is stable and leveled by using a spirit level. Install the safety buffer baffle above the hood.

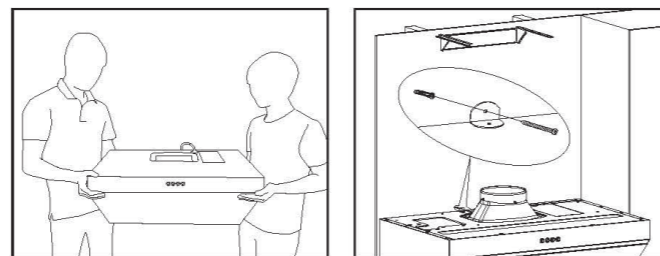

Caution: Two installers are required to ensure safe installation.

8. Secure the duct to the duct cover and seal the connection with aluminum tape. Make sure the hood is leveled. Install the Grease Cup, and plug the appliance for a test run.

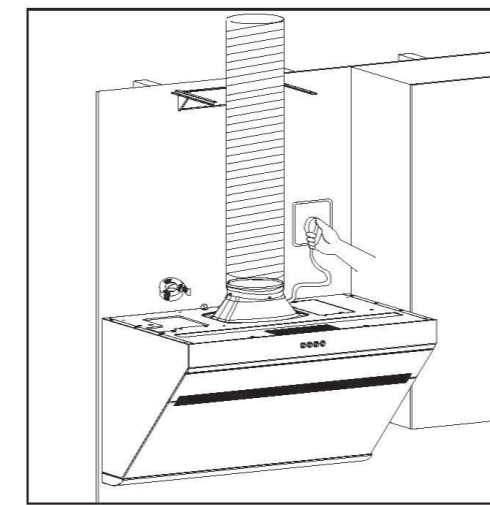

9. Tear off the protective film over the decorative cover and the blower housing; then install the decorative cover onto the brackets. Push the blower housing downward and lock it to the cover screws.

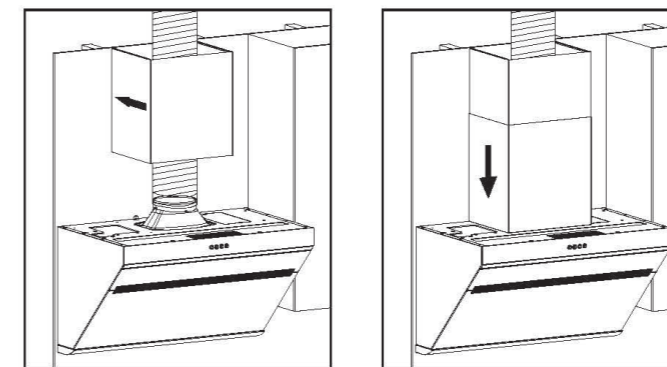

10. Install the smoke baffle plate.

- ① Remove the "Installation Tips" on the smoke baffle plate;
- ② Take out one screw in the accessory bag (keep another screw for backup);
- ③ Open the Smoke Baffle Plate to the maximum angle;
- ④ Fix the left bracket with the screwdriver and screw;
- ⑤ Install Collision Avoidance Elements on both left and right corners of the Smoke Baffle Plate.

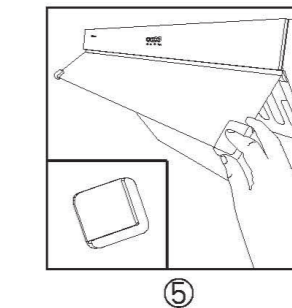
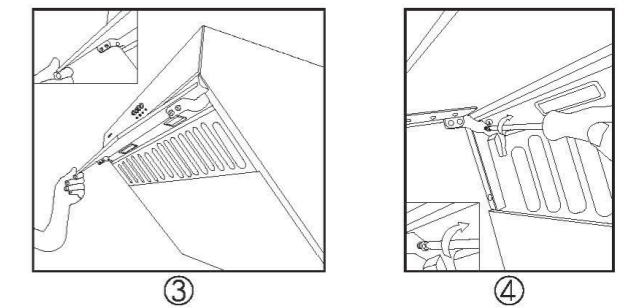
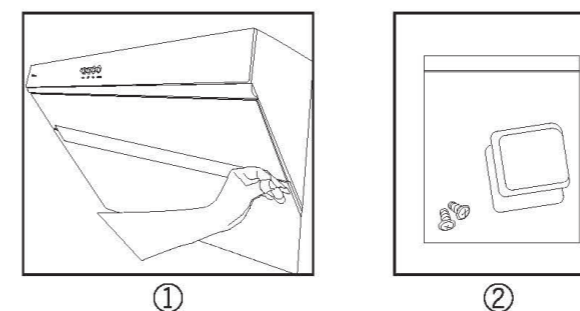

11. Make sure the hood is leveled. Install the Grease Cup, and plug in the appliance for a test run.

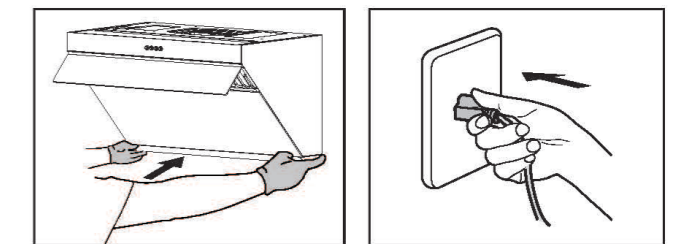

Warning: Please wear the qualified protective gloves in operation.

6.6 Test Run After Installation:

1. Press the "Lighting" button to check if the light is normal, then press the "Lighting" button again to reset, and the light will be turned off.

2. Press the "LOW-SETTING FAN/POWER" button to check the motor.

If any of the following malfunctions occurs, unplug the hood immediately and re-check the installation process. (If the malfunction continues, contact our authorized service center as soon as possible.)

- (1) The hood vibrates violently.
- (2) The impeller does not work.
- (3) The impeller grates while rotating.
- (4) The motor makes strange sounds.

3. Press the "LOW-SETTING FAN/POWER" button again to reset, and the motor will stop running.

Explosive View

