

User Instructions
MSA LUNAR

Order No.: 10214662/00
Print Spec: 10000005389 (EO)
CR: 800000046702

⚠ WARNING!

Read this manual carefully before using or maintaining the device. The device will perform as designed only if it is used and maintained in accordance with the manufacturer's instructions. Otherwise, it could fail to perform as designed, and persons who rely on this device could sustain serious injury or death.

The warranties made by MSA with respect to the product are voided if the product is not installed and used in accordance with the instructions in this manual. Please protect yourself and your employees by following the instructions.

Please read and observe the WARNINGS and CAUTIONS inside. For additional information relative to use or repair, call 1-800-MSA-2222 during regular working hours.

MSA is a registered trademark of MSA Technology, LLC in the US, Europe and other Countries. For all other trademarks visit <https://us.msasafety.com/Trademarks>.

This product incorporates Bluetooth® wireless technology. The Bluetooth word mark and logos are registered trademarks owned by Bluetooth SIG, Inc., and any use of such marks by MSA is under license. Other trademarks and trade names are those of their respective owners.



The Safety Company

1000 Cranberry Woods Drive
Cranberry Township, PA 16066
USA
Phone 1-800-MSA-2222
Fax 1-800-967-0398

For your local MSA contacts, please go to our website www.MSAsafety.com

Contents

1	Safety Regulations	5
1.1	Restrictions	5
1.2	Safety and Precautionary Measures	5
2	Overview	8
2.1	LUNAR	8
2.2	FireGrid	8
2.3	Safety io	8
3	Getting Started	9
3.1	In the Box	9
3.1.1	Accessories and Replacement Parts	9
3.2	Device Overview	10
4	Basic Operation	11
4.1	Attaching LUNAR to PPE	11
4.2	Powering On and Off	17
4.2.1	Powering On	17
4.2.2	Powering Off	17
4.3	TIC Display and Connected Device Status	18
4.4	Menus	21
4.4.1	Main Menu	21
4.4.2	Maintenance Menu	21
4.5	Activating an Alarm	22
4.6	Cancelling an Alarm	22
4.7	Pairing with an External Device	23
4.8	Configuring and Maintaining	24
4.8.1	Connecting to FireGrid Configure	24
4.8.2	Updating Firmware	26
4.8.3	Charging the Battery	27
4.8.4	Installing and Removing the Battery	28
4.8.5	Viewing Device Information	29
4.8.6	Viewing Battery Level and Device Assignment (Quick Check)	29
4.8.7	Maintaining LUNAR	30
4.8.8	Before Each Use	30
4.8.9	After Each Use	31
4.8.10	Storing LUNAR	31
5	Features	33
5.1	Starting a Search	33
5.2	Searching Overview	34
5.3	Canceling a Search	35
5.4	Exiting a Search Canceled by the Target	35
5.5	Acknowledging a PAR Check Notification	36
5.6	Acknowledging an Evacuate Notification	37
6	Learn More	38

- 6.1 Support 38
- 6.2 Specifications 38
 - 6.2.1 Radio 38
 - 6.2.2 Ingress Protection Rating 38
 - 6.2.3 Single-Point Charger International Input AC Power Plugs 38
- 6.3 Warranty 38
- 6.4 Certifications 39
 - 6.4.1 Certified Temperature Ranges 39
 - 6.4.2 Declaration of Conformity 39
- 6.5 Legal Notices 39

1 Safety Regulations

US

This device complies with part 15 of the FCC Rules. Operation is subject to the following two conditions: (1) This device may not cause harmful interference, and (2) this device must accept any interference received, including interference that may cause undesired operation.

Changes or modifications not expressly approved by the party responsible for compliance could void the User's authority to operate the equipment.

Canada

This device contains licence-exempt transmitter(s)/receiver(s) that comply with Innovation, Science and Economic Development Canada's licence-exempt RSS(s). Operation is subject to the following two conditions:

- (1) This device may not cause interference.
- (2) This device must accept any interference, including interference that may cause undesired operation of the device.

Cet appareil contient des émetteurs / récepteurs exempts de licence qui sont conformes au (x) RSS (s) exemptés de licence d'Innovation, Sciences et Développement économique Canada. L'opération est soumise aux deux conditions suivantes:

- (1) Cet appareil ne doit pas causer d'interférences
- (2) Cet appareil doit accepter toute interférence, y compris les interférences pouvant provoquer un fonctionnement indésirable de l'appareil

1.1 Restrictions

MSA LUNAR is not suitable for the following applications:

- Although the thermal imaging camera (TIC) is waterproof, it is unable to take underwater images.
- Likewise, the camera does not take images through glass, water or shiny surfaces which may reflect infrared light and may appear as a thermal image "mirror".
- The camera does not improve the user's sight. Corrective spectacles must continue to be worn.

Limitations

- Certified ambient operating temperature range: $-25^{\circ}\text{C} \leq T_{\text{amb}} \leq +40^{\circ}\text{C}$.
- Failure to properly use and maintain this product can result in injury or death.
- Never substitute, modify, add or omit parts. Use only exact replacement parts in the configuration as specified by the manufacturer.
- Refer to user instructions in this manual for information on use and maintenance of this device.
- Refer to user instructions in this manual before use.
- This device contains a battery and electronics. Dispose of or recycle in accordance with all applicable federal state and local regulations.

1.2 Safety and Precautionary Measures

WARNING!

The User must be trained and thoroughly familiar with proper operation and limitations of the device. Use in controlled live-burn exercises is suggested before using the device in actual emergency situations.

Do NOT rely on the device as the sole means of navigation, search and rescue, or alarm of a Target in distress. Do NOT deviate from standard firefighting navigational, search and rescue, or operating procedures and best practices during use. Radio-frequency based search and rescue technology is not a replacement for these procedures. Although the system provides an image in dark and smoky environments, the User may become disoriented or lost in such environments if the system becomes inoperative.

If a local alarm network or LTE network interruption occurs, or communication of devices or Cloud connectivity is slowed or prevented, standard firefighting navigational, search and rescue, and operating procedures must be followed.

Wireless and Bluetooth Operation is dependent upon signal availability of the wireless service(s) necessary to maintain the communication link. Loss of wireless signal will prevent communication of alarms and other information to linked devices and will prevent the use of LUNAR search capabilities. Take appropriate precautions in the event a loss of wireless signal occurs.

The search functionality is dependent upon the Target of the search having an operational, connected LUNAR device that is powered on, connected through wireless signal, and on the Target's person. If the LUNAR device is not operational, powered on, and connected through wireless signal, the Target will not be able to be searched. If the LUNAR device is not on the Target's person, the search function will lead searchers to the LUNAR device rather than the Target.

If the LUNAR device does not operate correctly as described in these instructions, remove the LUNAR device from service. Make sure an MSA trained and certified repair technician corrects the unsatisfactory condition before returning the LUNAR device to service. This device is NOT field serviceable.

Repair or alteration of the device beyond the procedures described in this manual or by anyone other than a person authorized by MSA could cause the unit to fail to perform properly. Use only genuine MSA replacement parts when performing any maintenance procedures described in this manual. Substitution of components can seriously impair performance of the unit, alter intrinsic safety characteristics, or void agency approvals.

Before and after each use, inspect the device to determine if servicing is required. Do not use if the device does not power on successfully or if device is bent, cracked, modified, or otherwise compromised.

Exposure to high temperature environments for an extended period of time may cause degradation or loss of thermal image. Avoid heat saturation or overexposure of the equipment. If degradation of the thermal image is observed, immediately remove the equipment from the high heat environment and allow it to cool until the thermal image returns to normal; otherwise, the system may become inoperative.

Do NOT mark the device with stamps, labels, paint, or other method. Use of such markings may interfere with camera use or may constitute a flammability hazard.

Do NOT charge LUNAR in explosive atmospheres.

Only charge LUNAR and LUNAR battery packs indoors.

Only charge the LUNAR battery in temperatures between 0°C (32°F) and 40°C (104°F).

Only charge LUNAR or LUNAR batteries with the Single-Point Charger or Universal Multi-Bay Charger with power supplies provided by MSA at time of purchase.

Do NOT use a rechargeable battery charging system, which includes the Single-Point Charger or Universal Multi-Bay Charger, power supply and power cords, if any component of the system shows damage. Replace the components if they show cracks or distortion, or if the cord shows damage or wear.

Keep LUNAR and rechargeable battery charging system dry. Do NOT disassemble, repair, or alter LUNAR or charging system. Do NOT immerse in water or other liquids.

Do NOT expose the rechargeable battery or charging system to high temperature or heating equipment including, but not limited to, direct sunlight and water heaters. Overheating may cause an explosion.

Do NOT drop, crush or puncture the rechargeable battery or charging system. Damage from such occurrences can lead to short-circuit and overheating of the equipment.

To prevent electric shock or fire, do not remove the cover or tamper with the case of the power supplies provided in each charging system. There are no user-serviceable parts inside. The power supplies contain hazardous voltages and must not be opened. Do not use if any damage to the power supply is observed, including bent prongs, cracked case, modified or compromised. To avoid the possibility of electric shock, disconnect electric power to the power supply before connecting or disconnecting the power supply to the charger clip or charger bay.

POWER SUPPLIES for Universal Multi-Bay Charger: AC Mains voltage must be provided to the power supply by a power supply cord approved to the national standards in which it will be used.

FUSING: Internal fuse for Line is provided in the power supply. A blown internal fuse is an indication of critical condition of circuit component(s). If you suspect a blown fuse, do NOT use the device. Return to MSA for service.

Do NOT dispose of batteries in a fire. Batteries can explode. Dispose of in accordance with local regulations and requirements.

Do NOT replace the battery with another type of battery. Use only LUNAR battery packs. Use of an incorrect battery type creates a risk of explosion.

Do NOT use a rechargeable battery pack that shows signs of damage such as bulging, swelling, leaking fluid, a cracked housing, or broken contacts.

Do NOT attempt to open the housing of the rechargeable battery pack. The rechargeable battery pack does not have replaceable cells.

Failure to follow these warnings can result in serious personal injury or death.

 **WARNING!/AVERTISSEMENT!**

Risk of explosion if battery is replaced with incorrect type.

Dispose of used batteries according to instructions. Do not disassemble, short circuit, or dispose of in fire.

Failure to follow these warnings can result in serious personal injury or death.

Risque d'explosion si la batterie est remplacée par un type incorrect.

Débarrassez-vous des piles usagées selon les instructions. Ne pas démonter, court-circuiter ou ne vous disposer dans le feu.

Le non-respect de ces avertissements peut entraîner des blessures graves ou la mort.

2 Overview

2.1 LUNAR

LUNAR is a wireless handheld search and rescue device that includes firefighter-to-firefighter ranging using direction and distance indicators, edge detection enhanced thermal imaging, and cloud connectivity to [FireGrid](#). It can be utilized independently of an SCBA - providing accountability to all firefighters on-scene.

LUNAR is not a substitute for standard techniques and precautionary measures. Users must continue to ensure standard operational processes are observed and maintained while using the device.

2.2 FireGrid

FireGrid is a cloud-based software platform that helps to improve firefighter safety by increasing a department's capability for managing products, people, and processes.

This platform includes the following:

- FireGrid Configure (mobile app)
- FireGrid Monitor (mobile app)
- FireGrid (web platform)

Learn more about FireGrid at <https://us.msasafety.com/connected-firefighter>.

2.3 Safety io

Safety io, LLC (a subsidiary of MSA The Safety Company) developed the FireGrid platform so that, among other things, LUNAR users can proactively and easily manage and monitor their devices.

For more information, visit <http://www.safetyio.com>.

3 Getting Started

3.1 In the Box

LUNAR comes with the following components:

- LUNAR Device
- LUNAR Battery
- Single-Point Charger
- LUNAR Quick Start Guide ([REF](#) 10215367)
- LUNAR Registration Guide (for registering a LUNAR device in FireGrid) ([REF](#) 10215366)

3.1.1 Accessories and Replacement Parts

Accessories and replacement parts can be purchased separately at <https://us.msasafety.com/>.

Accessories

Product	Part Number	Description
Retractor Assembly	10203941	Used to tether LUNAR to an SCBA. See " Attaching LUNAR to PPE " for more information.

Replacement Parts

Product	Part Number	Description
LUNAR Battery	10214756	The LUNAR device's removable, rechargeable power supply. Replace battery pack with LUNAR Battery MSA Part Number 10214756.
Boot	10214762	Rubber cover that wraps around the LUNAR device to protect from damage, corrosion, or deformation.
Quick-Disconnect Swivel	10214763	Connects to LUNAR so the device can be tethered to, for example, an external device or Turnout Gear.

Charging Products

Product	Part Number	Description
Single-Point Charger		
NNA	10214758	Allows charging of one LUNAR device or battery.
Europe	10214759	
UK/HK/SG	10214760	
AS/NZS	10214761	
Universal Multi-Bay Charger		
NNA	10214752	Allows charging of up to six LUNAR batteries at one time.
Europe	10214753	
UK/HK/SG	10214754	
AS/NZS	10214755	

3.2 Device Overview

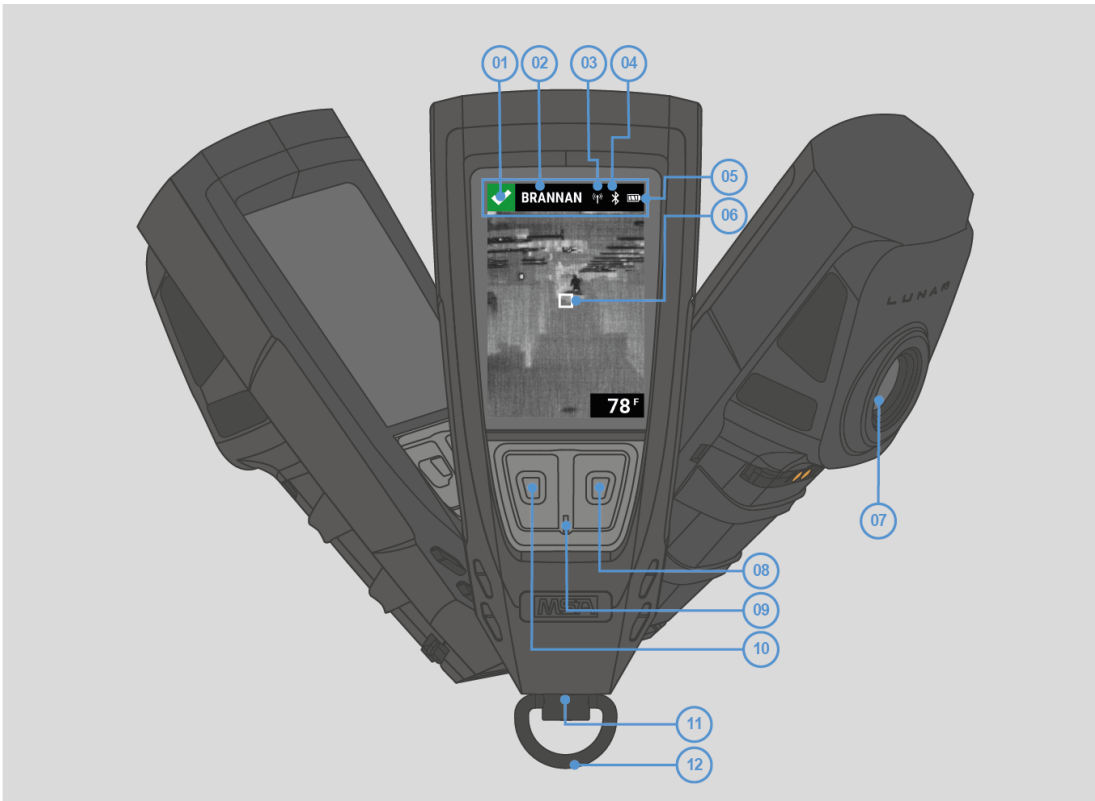

01	Status
02	ID
03	LTE connection
04	Bluetooth connection
05	Battery level
06	Display
07	TIC lens
08	'Enter' button. Press to select.
09	LED
10	'Down' button. Press to scroll.
11	RFID tag
12	Quick-Disconnect Swivel

4 Basic Operation

4.1 Attaching LUNAR to PPE

LUNAR can be tethered to an SCBA using an MSA [Retractor Assembly](#).

⚠ WARNING!

Ensure LUNAR is securely attached using a tether by following the instructions below for donning LUNAR.

If using a tether other than the MSA Retractor Assembly, ensure that the tether material and connection method are capable of withstanding the loading and environmental conditions that will be encountered during use.

Failure to follow this warning can result in serious personal injury or death.

Retractor Assembly Components

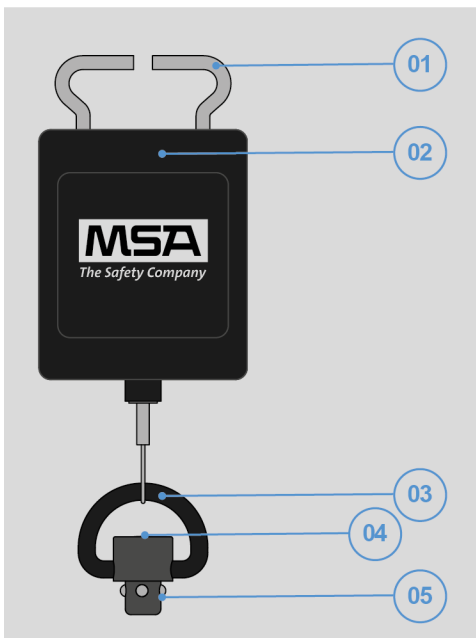

01	Split D-ring
02	Retractor
03	Quick-Disconnect Swivel
04	Swivel Button
05	Swivel End

First, remove the Quick-Disconnect Swivel (03) that comes attached to the bottom of LUNAR:

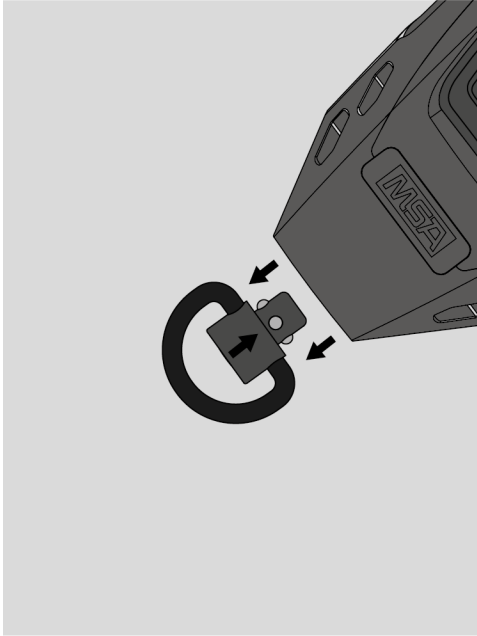

- (1) Push and hold in the LUNAR Swivel Button (04).
- (2) With the button depressed, pull the Quick-Disconnect Swivel (03) to remove.

Then follow the instructions for the applicable SCBA:

- [Tethering LUNAR to a G1 SCBA](#)
- [Tethering LUNAR to an M1 SCBA](#)

Tethering LUNAR to a G1 SCBA



- (1) Identify the G1 SCBA shoulder strap webbing loop (07) within the strap tunnel (06) on the User's left-hand side.

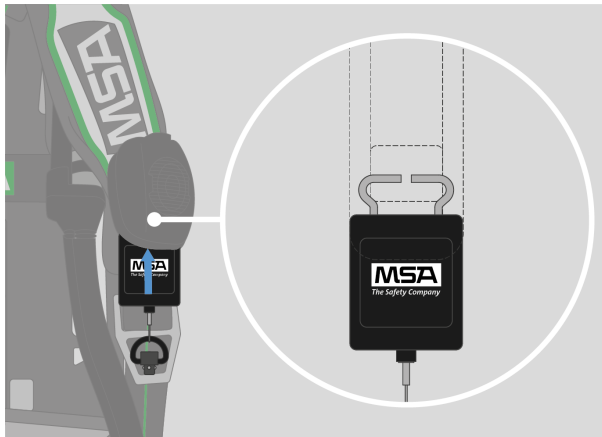

- (2) Slide the Retractor (02) up the G1 SCBA strap tunnel (06) until the Split D-ring (01) is above the specified stitch.

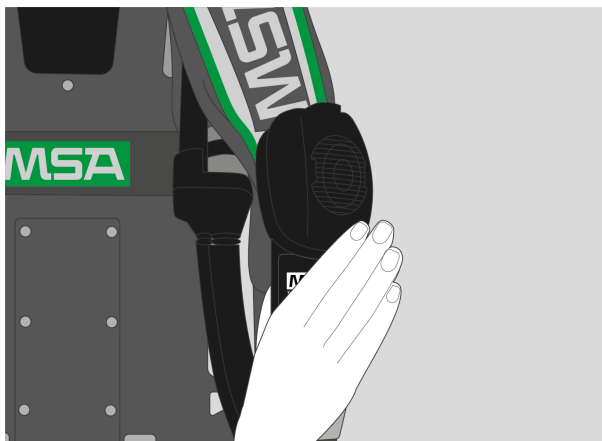

- (3) From outside of the G1 SCBA strap tunnel (06), secure the Retractor (02).

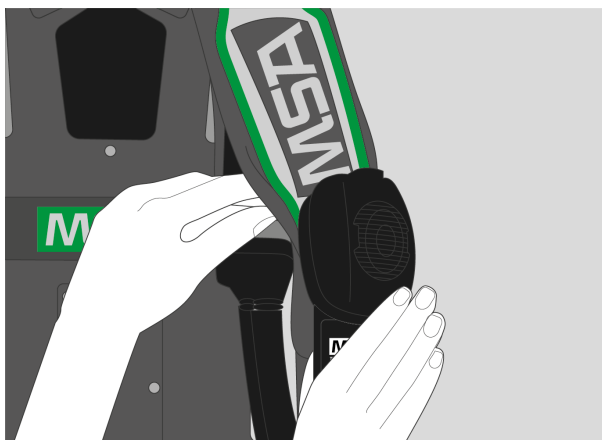

- (4) Reach into the G1 SCBA side access tunnel (08). At this point, the Split D-ring (01) should be in front of the webbing.

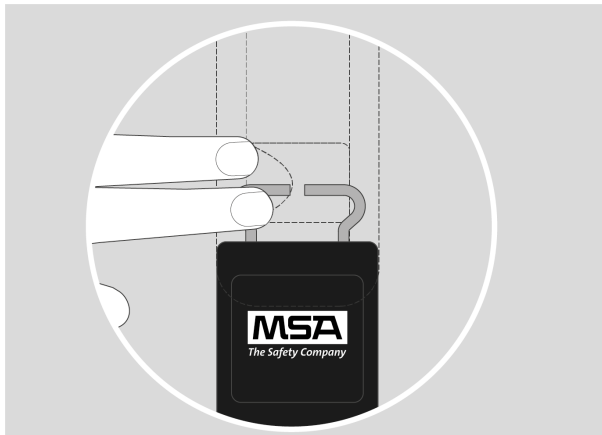

- (5) Fold the G1 SCBA shoulder strap webbing until one end can feed between the gap in the Split D-ring (01).



- (6) Work the rest of the G1 SCBA shoulder strap webbing through the gap. The Split D-ring (01) should now be fully supported by the specified stitching loop.

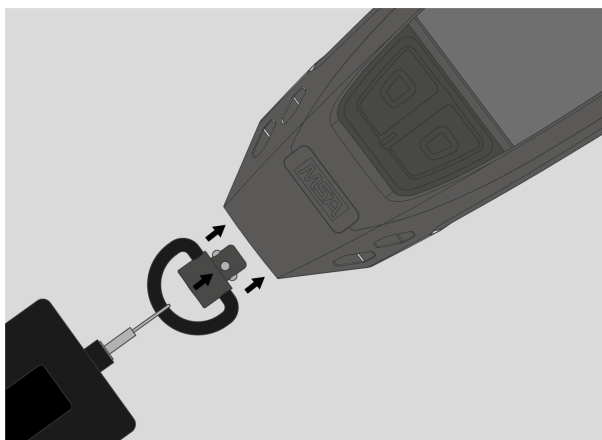

- (7) Attach the Retractor (02) to the bottom of LUNAR:
- a) Push and hold in the Retractor Swivel Button (04).
 - b) Insert the Swivel End (05) into the bottom of LUNAR.
- (8) Release the Retractor Swivel Button (04) and ensure that Retractor Assembly is connected and swiveling freely.

Tethering LUNAR to an M1 SCBA

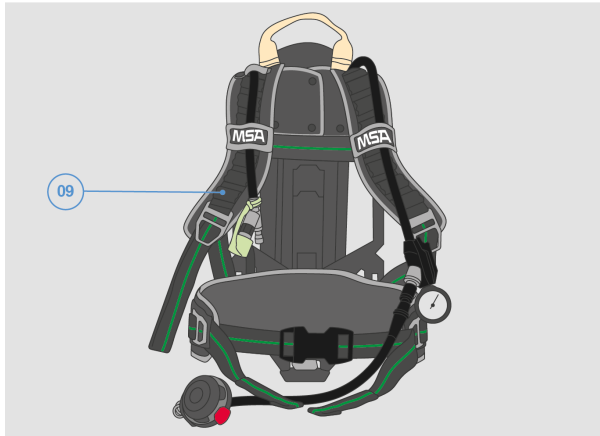

- (1) Identify the M1 SCBA shoulder strap webbing loop (09). It sits on the User's right-hand side, one loop above the strap adjustment.

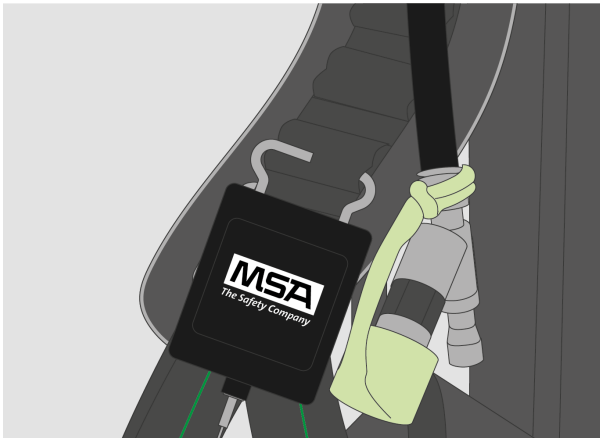

- (2) Slide the webbing loop (09) between the gap in the Split D-ring (01) until half of the webbing is within the Split D-ring and half of the webbing is underneath it.

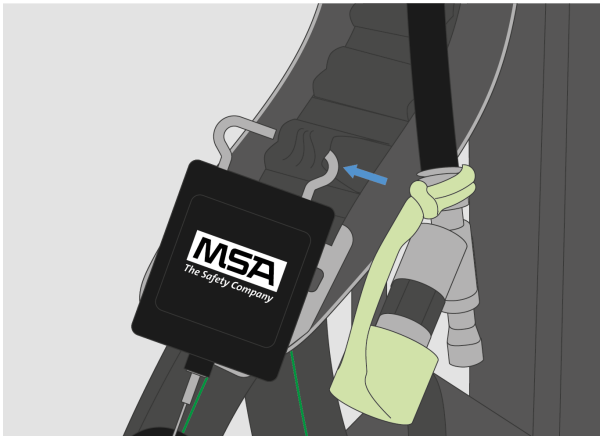

- (3) Grip the Retractor (02) and pull forcefully to the User's right. Fold the webbing loop (09) under the Split D-ring (01) until it is able to slide between the gap and within the Split D-ring. Note that the stitching on these loops is robust and can handle the amount of force required.

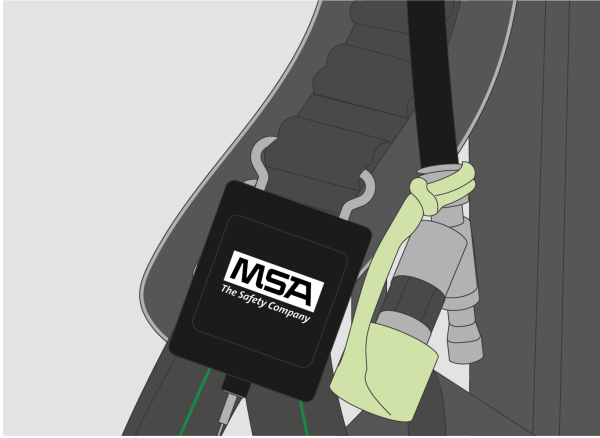

- (4) Flatten out the webbing loop (09) once it is fully contained within the Split-D ring.

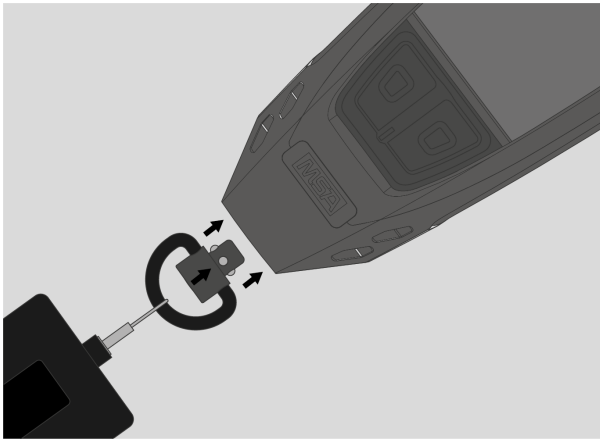

- (5) Attach the Retractor (02) to the bottom of LUNAR:
 - a) Push and hold in the Retractor Swivel Button (04).
 - b) Insert the Swivel End (05) into the bottom of LUNAR.
- (6) Release the Retractor Swivel Button (04) and ensure that Retractor Assembly is connected and swiveling freely.

Orienting LUNAR



The LUNAR device directional search antenna is aligned with the axis of the [Thermal Imaging Camera \(TIC\)](#).

The directional search signal you receive is the signal from the area shown in the thermal image.

4.2 Powering On and Off

4.2.1 Powering On



Long press the **Down** or **Enter** button.

NOTES:

Installing a charged battery also powers on the device. See ["Installing and Removing the Battery"](#).

Attempting to power on a LUNAR device with a low battery level results in a flashing Low Battery icon, and LUNAR shuts down. See ["Charging the Battery"](#).

4.2.2 Powering Off

- (1) Open the [main menu](#).
- (2) Select **SHUTDOWN**.
- (3) Select **YES** to confirm shutdown.

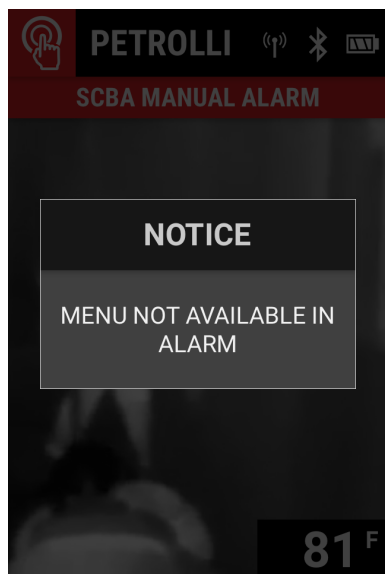
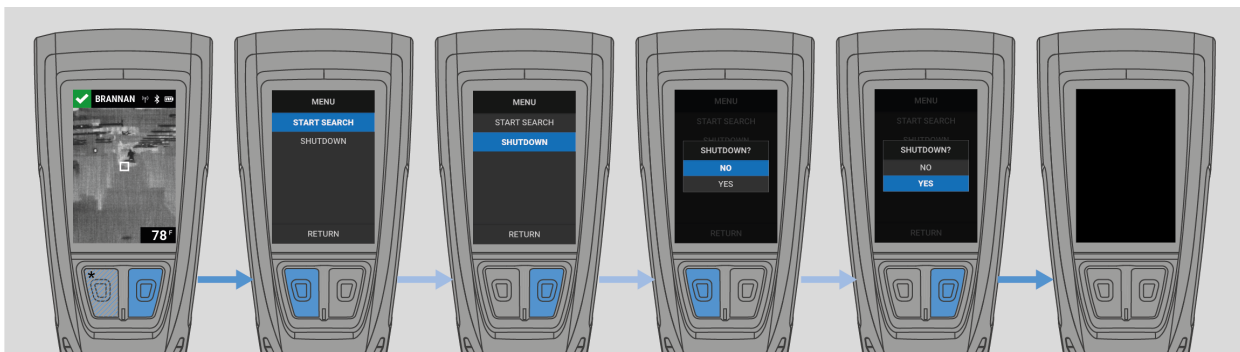

NOTE: LUNAR cannot be powered off or enter *Search* mode during a Manual, Motion, or Hardware alarm.





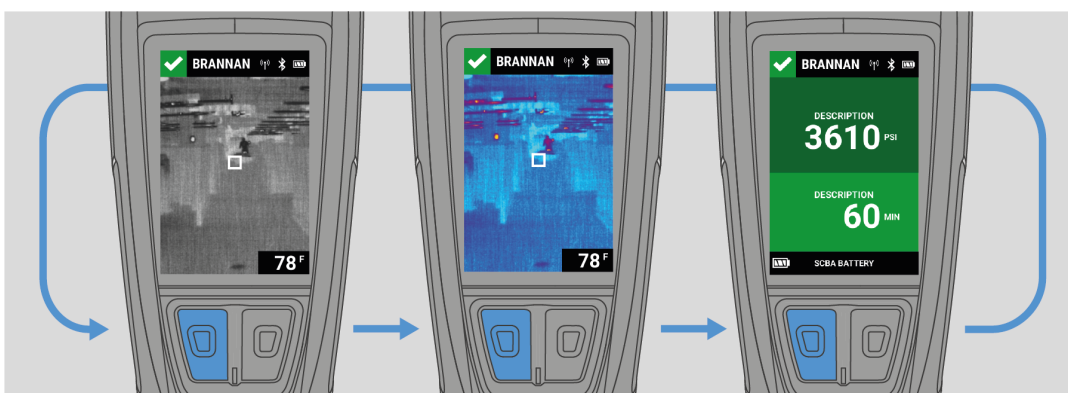













4.3 TIC Display and Connected Device Status

The Thermal Imaging Camera (TIC) Display is the default LUNAR screen. From this screen, the configured TIC palettes can be scrolled by pressing the **Down** button. If LUNAR is connected to Bluetooth and [paired with an external device](#), the status of the connected device can also be viewed.



NOTE: If LUNAR is not connected to Bluetooth or if the connection is lost, the Status screen will not be available.

Status Icons

Icon	Description
	Device is working with alarm network enabled.
	Device is working with alert network disabled.
	Search Mode
	Low Battery Alarm
	Manual Alarm
	Evacuation Alarm
	Hardware Alarm
	Motion Alarm
	Low Pressure Alarm
	PAR Check
	Strong LTE Connection
	Moderate LTE Connection
	Weak LTE Connection
	No LTE Connection
	Battery Level at 100%-75%
	Battery Level at 75%-50%
	Battery Level at 50%-25%
	Battery Level at 25%-0%
	Bluetooth Connection On



Icon	Description
	Bluetooth Connection Off

Notification Banner

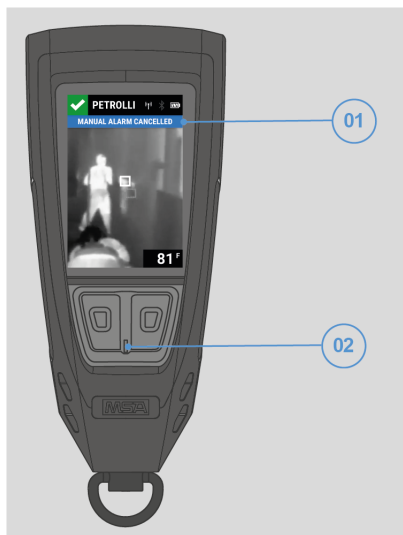

Notifications and alarms are displayed in the notification banner (01). The notification type determines the color of the banner along with the LED (02) color and behavior.



(01) Notification Banner Color

-  Notifications and Alerts
-  Alarms

(02) LED

-  Normal operation
-  Paired with external device
-  Alarm

Notifications and alerts

 **NOTE:** Initially, the LED blinks at the rate of the notification sound. Once the sound stops, the blink rate is slow.

Notification and Alert Types

- | | |
|------------------------|--|
| Motion Pre-Alarm | Evacuate |
| PAR Check | SCBA/External Device Connection Lost |
| PAR Check Acknowledged | No LTE Connection |
| Target Signal Lost | SCBA/External Device Low Pressure Alarm |
| Evacuate Acknowledged | LUNAR Low Battery Warning |
| Firefighter Alarm | SCBA/External Device Low Battery Warning |

Alarm Types

Any full alarm, including the following alarms, continuously sound and are displayed in the notification banner while they remain active.

Motion Alarm	A search cannot be started and LUNAR cannot be powered off once a Motion,
Manual Alarm	Manual, or Hardware alarm is activated.
Hardware Alarm	

NOTE: If there are one or more active alarms on the device or if a PAR Check is active, notifications can still be received. The red alarm notification banner is briefly replaced with the blue notification banner.

4.4 Menus

4.4.1 Main Menu

To open the main menu from the [Display](#), press the **Enter** button.

From the main menu, the User can:

- [start a search](#)
- [power off the LUNAR device](#)

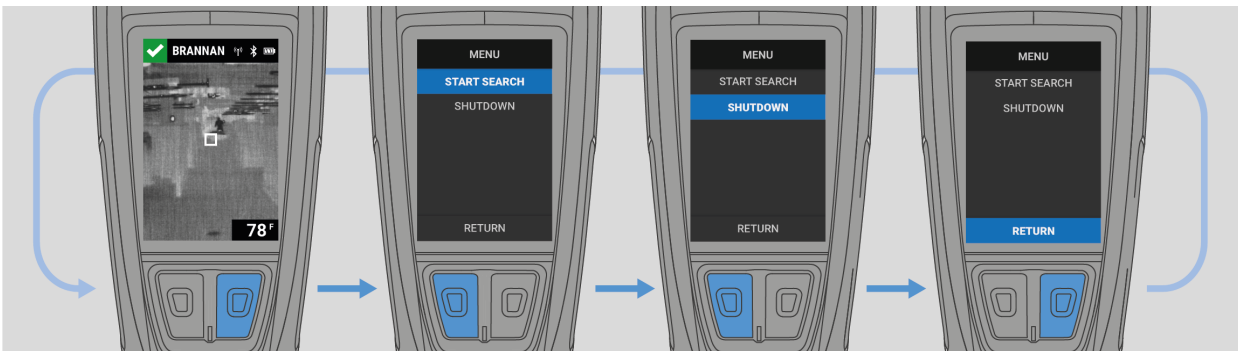

4.4.2 Maintenance Menu

To open the Maintenance menu:

- (1) With the power off, press the **Down** or **Enter** button to [activate a Quick Check](#).
- (2) Long press both buttons together.

From the Maintenance menu, the User can:

- [connect LUNAR with FireGrid Configure](#)
- [update firmware software](#)
- [view device information](#)

4.5 Activating an Alarm

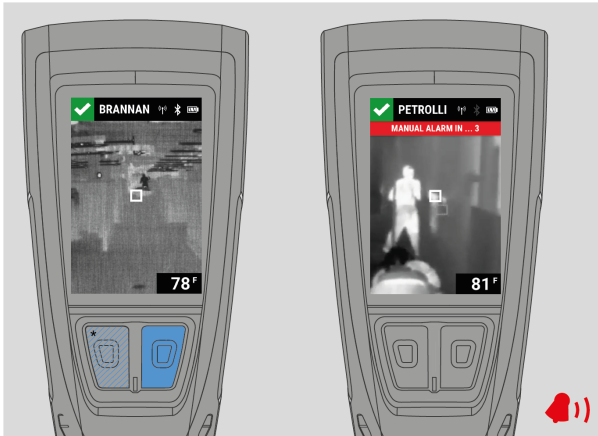

Long press the **Down** or **Enter** button.

NOTE: If the button is released before the countdown ends, the alarm is not activated.

4.6 Cancelling an Alarm

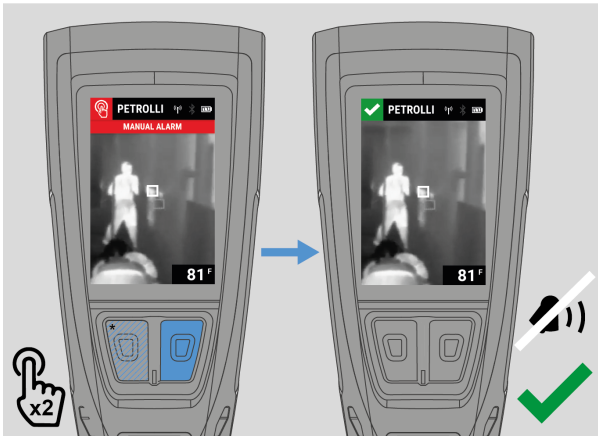

Double press the **Down** or **Enter** button.

If LUNAR is connected to an SCBA or external device and receives an alarm about the connected device, the alarm must be canceled, or reset, on the connected device. For more information on canceling an alarm on an SCBA or external device, see the device's user instruction manual.

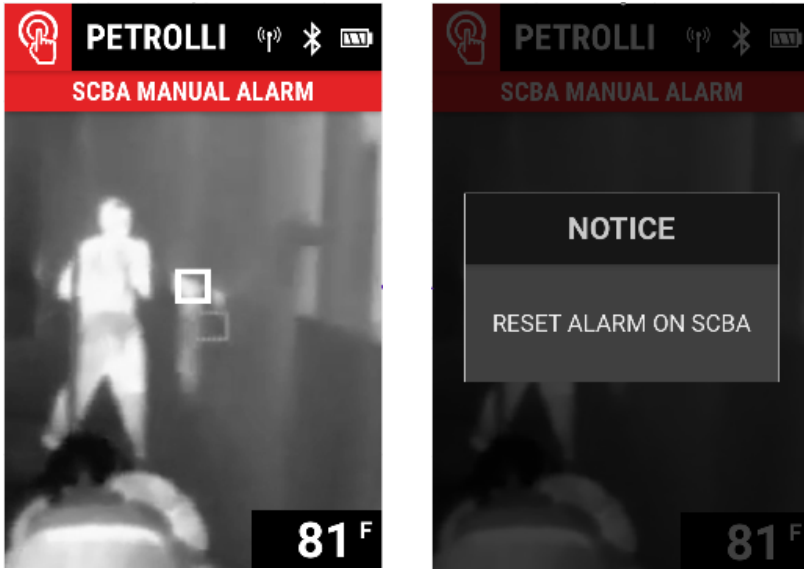

4.7 Pairing with an External Device

WARNING!

When pairing LUNAR with an external device, LUNAR must only be paired to the external device being worn by the User of the LUNAR. Failure to pair the two devices or pairing the LUNAR with an external device being worn by another User can result in unintended alarm communications including, but not limited to:

- Unintended deactivation of the motion sensing alarm on LUNAR
- Command center alarms not being received or being received by an unintended User
- External device or LUNAR alarms not being received by the command center or appearing to come from a different User than the one experiencing the alarm
- Incorrect alarm information being sent to searchers resulting in the searchers targeting the wrong LUNAR device to locate a User in distress

Failure to follow these warnings can result in serious personal injury or death.

Pairing can be established with external devices using the RFID tag in LUNAR.

- (1) Ensure the external device is powered on and ready to read an RFID tag. Refer to the external device's user instruction manual for more information.
- (2) Ensure LUNAR is powered on.

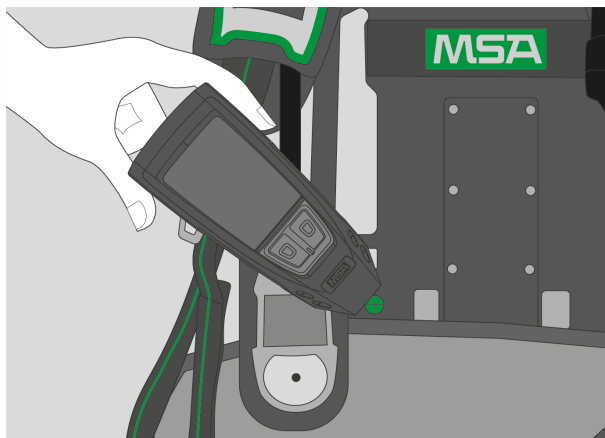

- (3) Touch the RFID tag location on LUNAR to the tag reading location on the external device.

- (4) [Scroll through the LUNAR TIC palettes](#) until the Status screen is displayed.

Successful Connection

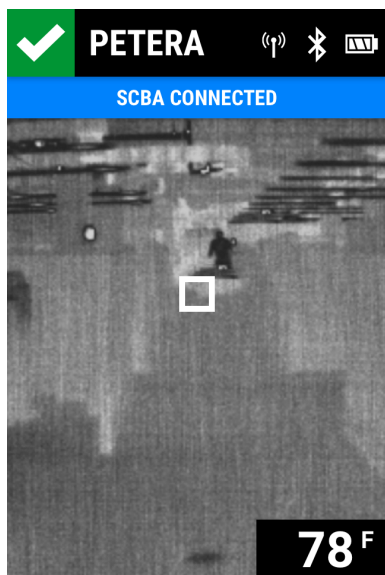

Connection Established and then Lost

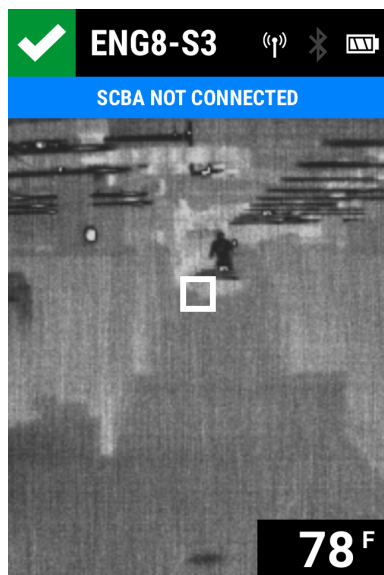

4.8 Configuring and Maintaining

4.8.1 Connecting to FireGrid Configure

LUNAR can be configured to connect with FireGrid Configure, making it discoverable for communication with FireGrid.

- (1) With LUNAR powered off, [start a Quick Check](#).

- (2) Open the [Maintenance menu](#).
- (3) Select **DATA LINK**. LUNAR is available for communications. FireGrid initiates the communications with the device.

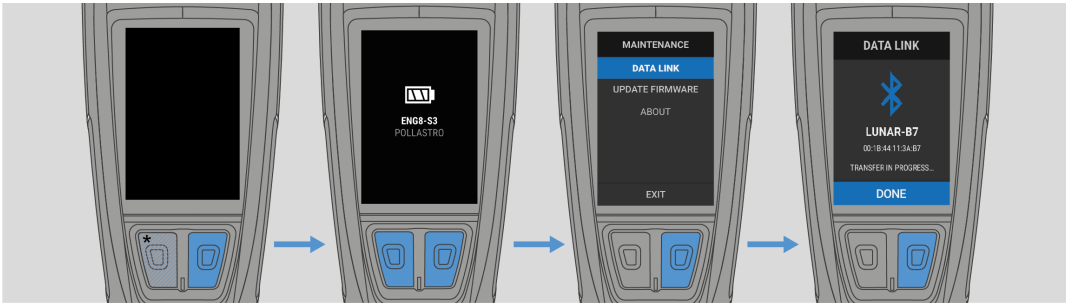

Connection in Progress

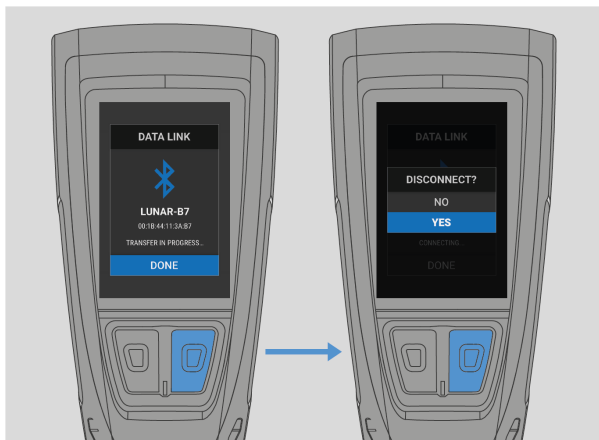

- (1) Select **DONE**.
- (2) In the **DISCONNECT?** dialog box, select **YES** to disconnect or **NO** to remain paired.

Not Actively Transferring Data

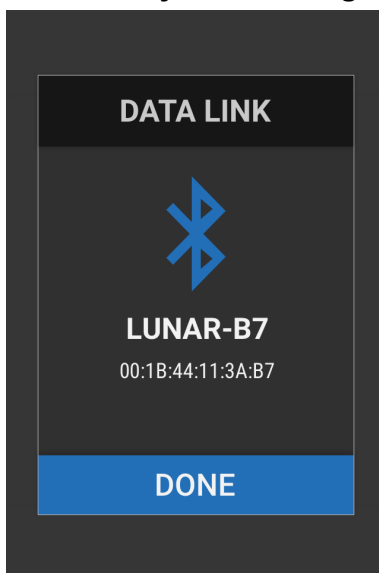

4.8.2 Updating Firmware

Using an LTE Connection

Firmware updates, if available, can be installed from the Maintenance menu.

- (1) Open the [Maintenance menu](#).
- (2) Select **UPDATE FIRMWARE**. This option is shown only if an update is available.
- (3) Select **YES** to confirm the update.

To cancel the update, select **CANCEL**.

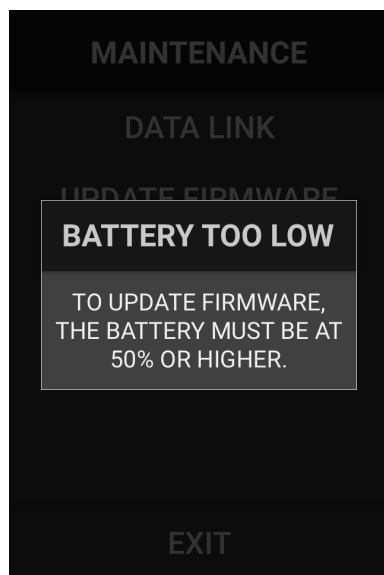
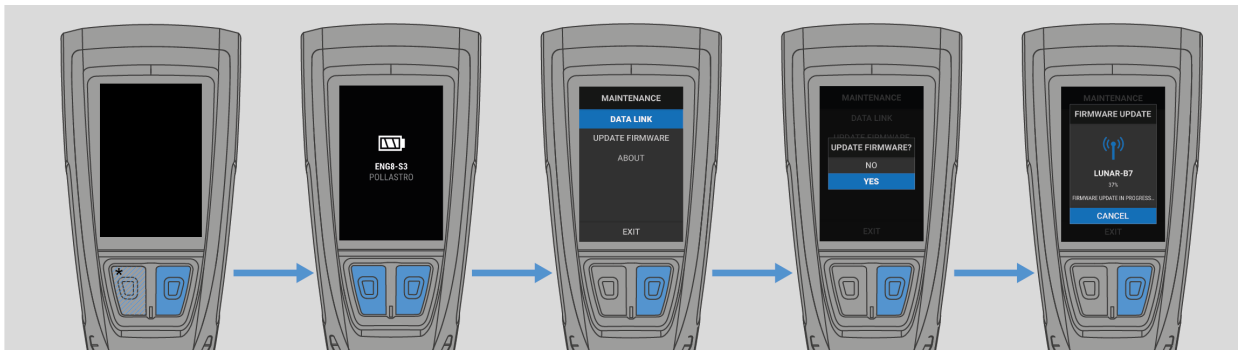

NOTE: To update the firmware, the battery level must be at 50% or higher.

Using FireGrid Configure

Firmware can be updated on LUNAR devices specified in the FireGrid Configure mobile app.

Connect LUNAR with FireGrid. See "[Connecting to FireGrid Configure](#)".

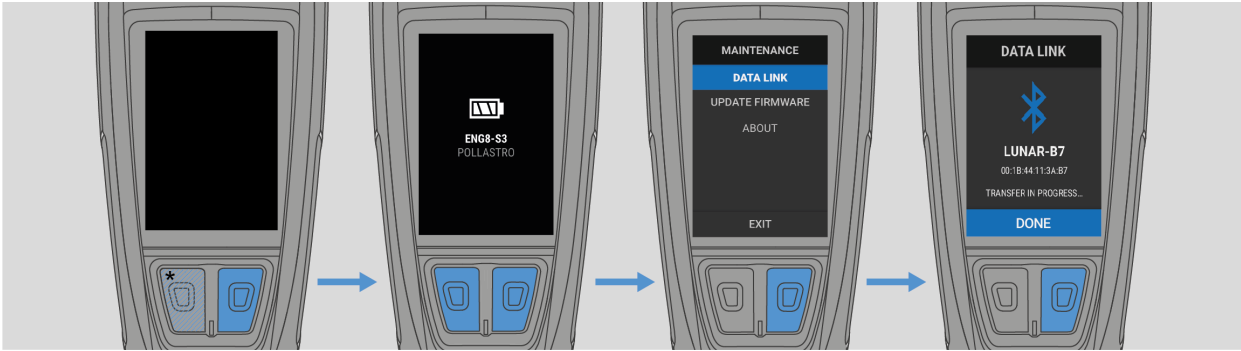

For more information, see the [FireGrid User Instructions](#) (REF 10219194).

4.8.3 Charging the Battery

There are two ways to charge the LUNAR battery:

(1) Using the Single-Point Charger

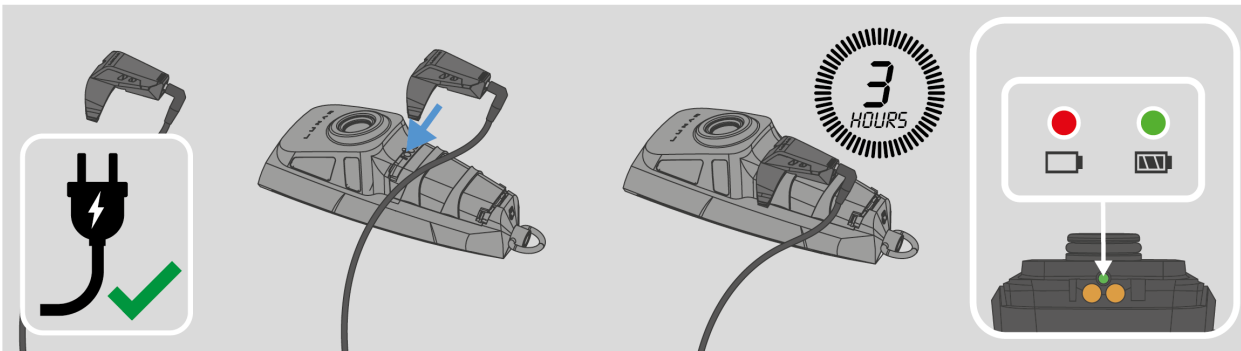

NOTE: If LUNAR is powered on and the Single-Point Charger is plugged into an outlet, the device automatically powers off after a period of time.

The battery can also be removed from LUNAR and inserted into the Single-Point Charger to charge.

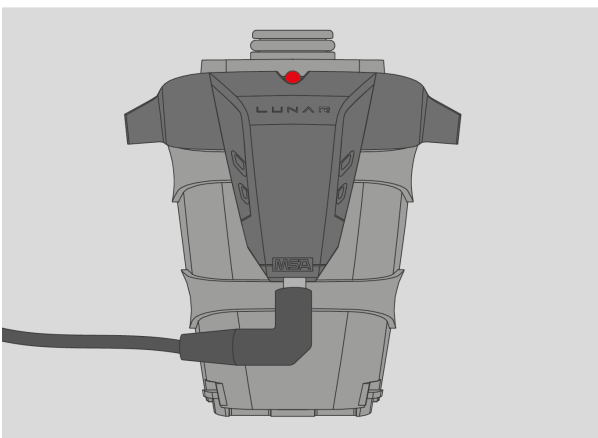

(2) Using the Universal Multi-Bay Charger

See the Universal Multi-Bay Charger quick start guide (REF 10214682).

4.8.4 Installing and Removing the Battery

WARNING!

Do not remove or install battery in explosive atmospheres.

Failure to follow this warning can result in serious personal injury or death.

Battery Overview

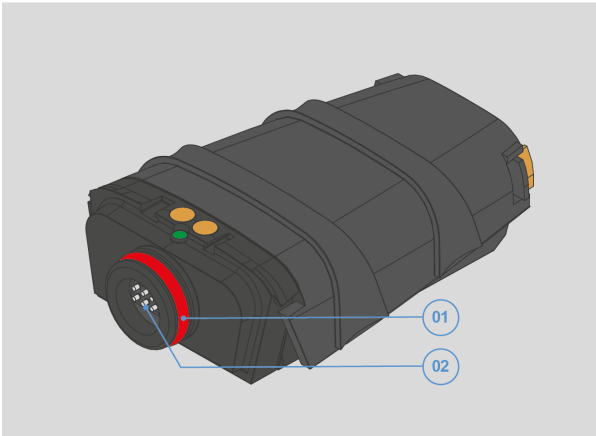

If the battery has been removed, ensure the LUNAR battery connecting port (02) is clean and dry prior to installing the battery to prevent corrosion or damage.

Installing the Battery

WARNING!

Prior to installation of the battery:

- Inspect the O-ring and seal surface on the battery (01) for damage or degradation.
- Ensure LUNAR device and battery are clean and dry, or corrosion or connector damage may occur resulting in intermittent or unexpected loss of power to the device.

Failure to follow this warning can result in serious personal injury or death.

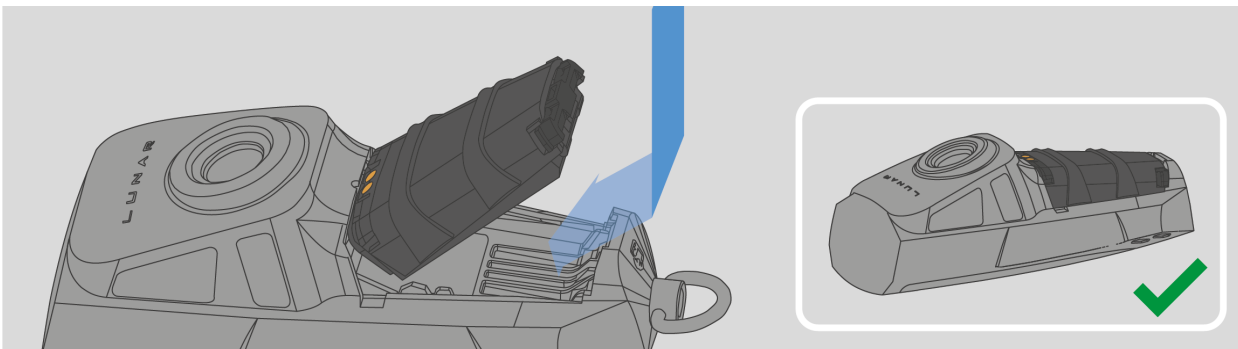

Removing the Battery

WARNING!

LUNAR device must be clean and dry prior to removal of the battery to prevent moisture or contaminants from entering the electrical connector area resulting in intermittent or unexpected loss of power to the device.

Failure to follow this warning can result in serious personal injury or death.

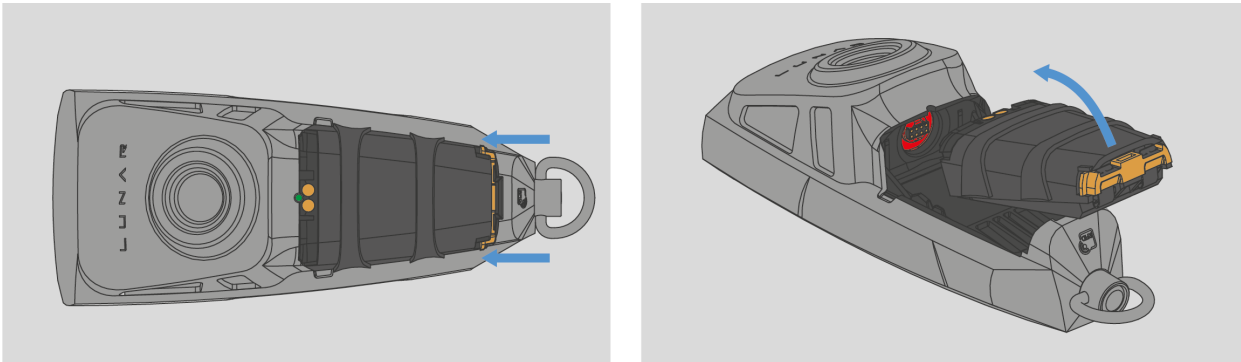

4.8.5 Viewing Device Information

Device information can be viewed from the Maintenance menu.

- (1) Open the [Maintenance menu](#).
- (2) Select **ABOUT**.
- (3) Scroll to view the information and select **DONE** to return to the Maintenance menu.

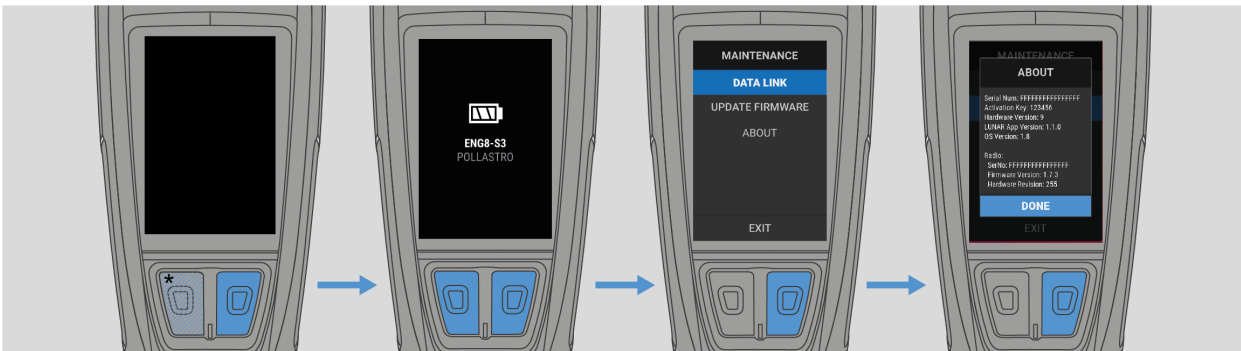

4.8.6 Viewing Battery Level and Device Assignment (Quick Check)

When LUNAR is powered off, a Quick Check can be activated to view the battery level and device assignment.

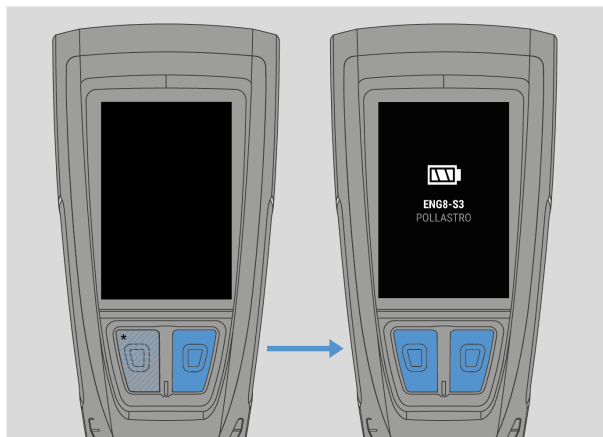

Press either the **Down** or **Enter** button.

4.8.7 Maintaining LUNAR

Make sure this product is inspected and serviced regularly.

Keep detailed inspection and service records.

MSA is liable only for maintenance and repairs performed by MSA.

MSA recommends maintenance intervals that follow the overhaul and flow test requirements for the SCBA to which it is attached.

Use only genuine MSA replacement parts.

Changes to devices or components are not permitted and will result in unapproved configurations.

4.8.8 Before Each Use

Each time LUNAR is used, a visual and operational inspection must be performed on the device following the criteria below:

- Check for housing damage due to mechanical, chemical or thermal loads.
- Check for cracks and other damage to the Display and TIC lens.
- Ensure LUNAR battery is charged.
- Ensure LUNAR powers on.
- Ensure Motion Alarm activates when LUNAR does not move for an extended period.
- Ensure a Manual Alarm can be activated.
- Ensure a search can be started.
- Ensure the Thermal Image is clear and responsive.

The LED blinks green slowly to indicate normal operation. If any of these criteria above are not met and the LED is not blinking green, remove the device from service until the condition is addressed.

In addition to the LUNAR inspection, ensure the LUNAR device is properly connected to the desired SCBA or external device:

- (1) Activate an alarm on the connected SCBA or external device.
- (2) Ensure the alarm appears on the LUNAR device.
- (3) Cancel the alarm on the connected SCBA or external device.

For more information on activating and canceling an alarm on an SCBA or external device, see the device's user instruction manual.

WARNING!

When pairing LUNAR with an external device, LUNAR must only be paired to the external device being worn by the User of the LUNAR. Failure to pair the two devices or pairing the LUNAR with an external device being worn by another User can result in unintended alarm communications including, but not limited to:

- Unintended deactivation of the motion sensing alarm on LUNAR
- Command center alarms not being received or being received by an unintended User
- External device or LUNAR alarms not being received by the command center or appearing to come from a different User than the one experiencing the alarm
- Incorrect alarm information being sent to searchers resulting in the searchers targeting the wrong LUNAR device to locate a User in distress

Failure to follow these warnings can result in serious personal injury or death.

4.8.9 After Each Use

Keep the battery installed for cleaning and disinfection to ensure the connector port remains clean and dry.

Depending on the cleaning policy adopted, either a designated person or the User should clean the LUNAR after each use to limit exposure to possible contamination that may be present on the unit after firefighting activities. ANSI standards suggest that Users should be trained in the cleaning procedure.

Confidence Plus® Cleaning Solution (REF 10009971) from MSA is recommended. It cleans and disinfects in one operation. It retains its germicidal efficiency in hard water to inhibit the growth of bacteria. It will not deteriorate rubber, plastic, glass, or metal parts. Refer to the label to prepare the Confidence Plus Cleaning Solution.

If the Confidence Plus Cleaning Solution is not used, wash in a mild cleaning solution, rinse thoroughly.

After cleaning and disinfection:

- Carefully clean the Display and TIC lens with a lint-free, isopropyl alcohol wipe.
- Carefully dry using a soft, lint-free cloth. Avoid scratching the Display and TIC lens.
- Ensure the germanium window Display and TIC lens do not have debris, cracks or other visible damage.
- Charge the LUNAR battery.

NOTICE

Do not use any solvents or thinners to clean the TIC lens as they may attack the camera housing materials. Do not use abrasive cleaners or cloths for cleaning the TIC lens as these may also damage the camera.

4.8.10 Storing LUNAR

- Do not store LUNAR within or near an area where the device might be exposed to any substances and/or ambient conditions that might attack any part of the device, causing LUNAR to not perform as designed and approved.
- Do not store LUNAR for extended periods with the battery installed if the device is not intended for service. If LUNAR is in service, ensure that the battery is charged.
- Ensure the entire LUNAR device is clean and dry.
- Place LUNAR in a suitable storage location so it can be easily reached for emergency use.

- Store the device in a cool, dry place.

5 Features

5.1 Starting a Search

Start a new search or join a current search from the main menu. Up to four Users can participate in a search for a given Target at one time.

- (1) Open the [main menu](#).
- (2) Select **START SEARCH**.
- (3) Scroll the list of names. All Targets with alarms activated are listed.
- (4) Select the name of the Target and start or join the search.

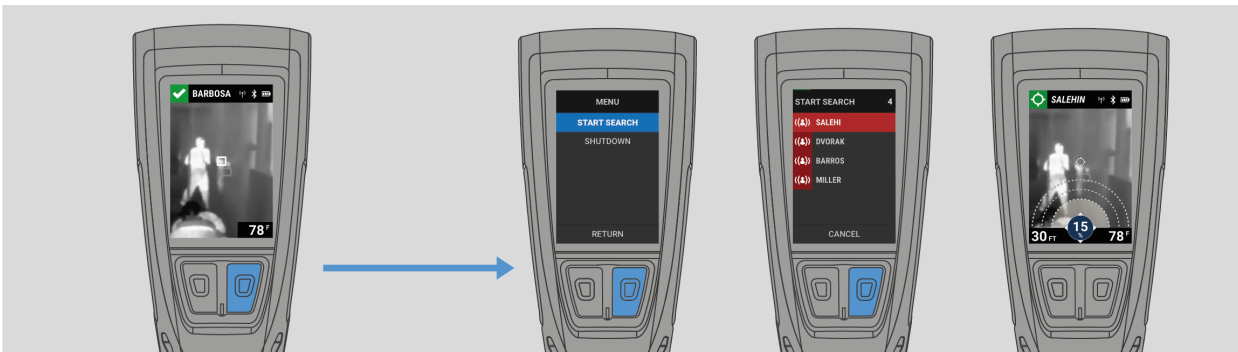

If a Target is out of range or has a low battery level, or if four searchers are already participating in the search, the Target cannot be searched:

Out of Range

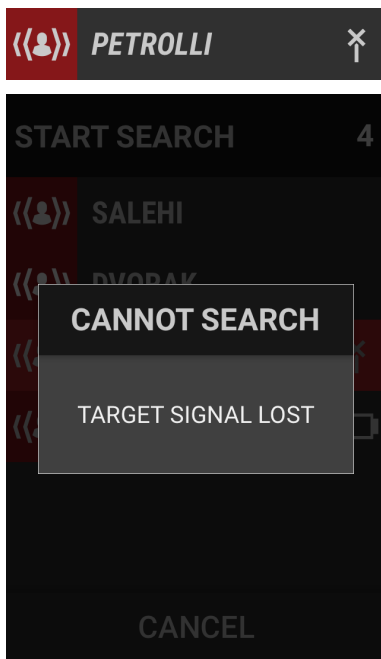

Target device loses power

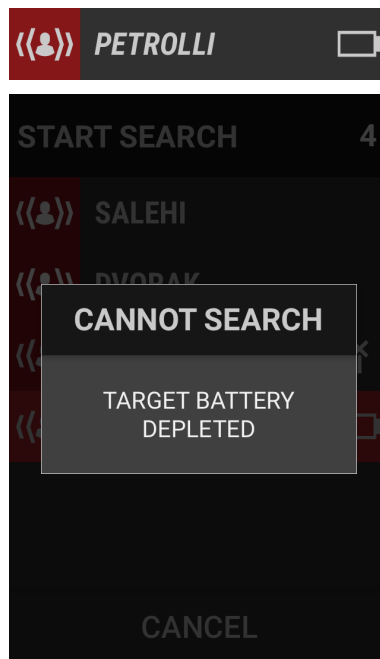

Maximum searchers

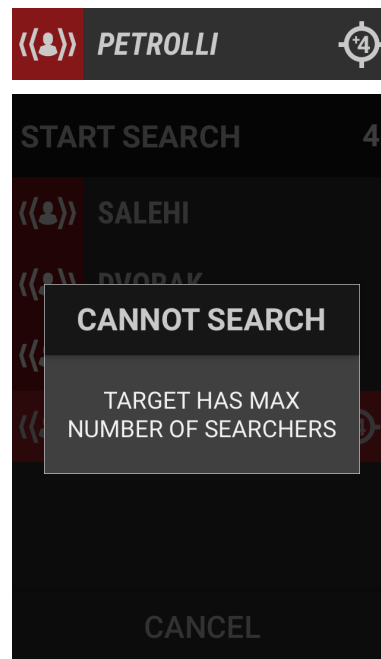

5.2 Searching Overview

Once a search is started, LUNAR enters *Search* mode. Use the direction and distance indicators on the Display to help locate the Target.

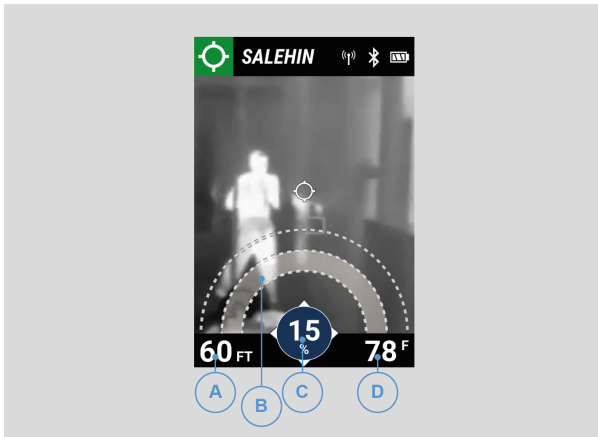

A	Distance (measurement)	Indicates distance, in feet or meters, from the Target.
B	Distance ¹ (visual indicator)	Arcs are directly correlated to distance from the Target. As the Searcher gets closer to the Target, the inside arcs are indicated.
C	Directional strength	Indicates the direction of the Target using: <ul style="list-style-type: none"> • Numbers - A scale from 0 to 100 with 100 representing the strongest source of signal. • Colors - Directly correlated to the signal strength. The lighter the color, the stronger the signal. <p>NOTE: At further distances or with more obstructions between the searcher and Target, the directional strength indicator will provide lower values. As the Searcher gets closer and orients the device toward the Target, these numbers will increase.</p>
D	Thermography	Temperature of the surface or item at the center indicator of the thermal image. (optional setting) <p>NOTE: Thermography cannot indicate the temperatures of gases and is dependent on properties of the surfaces measured. Shiny surfaces such as glass, tile, polished metal, etc., will not provide accurate thermography readings due to the reflection of IR energy from these surfaces.</p>

¹Distances are approximations and may vary based on environmental conditions.

NOTE: Indicators showing dashes instead of a number and no arcs indicate the signal is lost.

5.3 Canceling a Search

- (1) While in *Search* mode, press the **Enter** button.
- (2) Select **YES** to cancel the search. To exit the dialog box and continue the search, select **NO**.

Figure 1

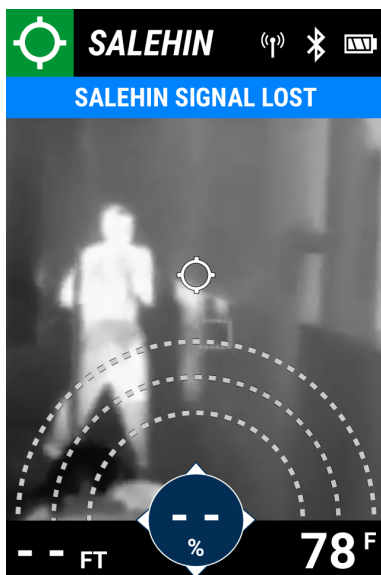

If the Target signal is lost before a search is ended because the Target is out of range or if the device has shut down due to power/a low battery level, LUNAR will try to re-acquire the signal.

If it is unable, the Distance and Direction strength indicators appear as dashes, and the Search proximity arcs are grayed out. After a brief time, the dialog box in [Figure 1](#) opens.

Cancel or continue the search. If continued, LUNAR will continue trying to re-acquire the signal.

5.4 Exiting a Search Canceled by the Target

In *Search* mode, if the Target of a search cancels the alarm on his LUNAR device, Users receive a notification. Searchers can then exit the search or start a new search for another Target.

Exit Search

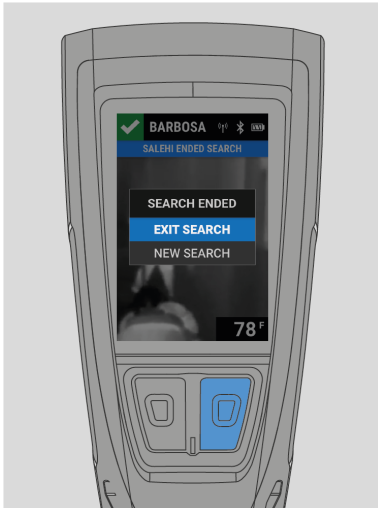

Select **EXIT SEARCH**. LUNAR returns to the [Display](#).

Start New Search

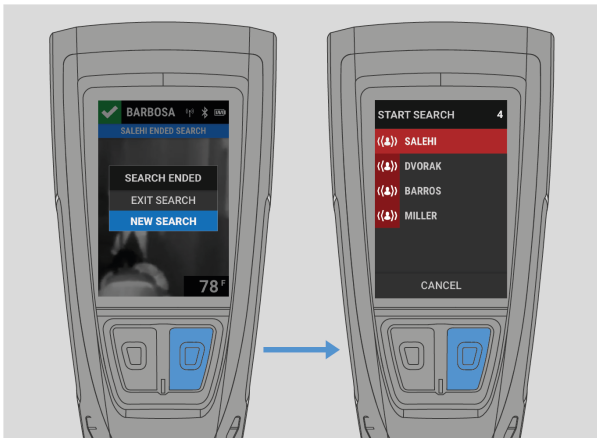

- (1) Select **NEW SEARCH**.
- (2) Scroll the list of names.
- (3) Select the name of the Target to locate and start or join the search. See "[Starting a Search](#)".

5.5 Acknowledging a PAR Check Notification

Use a Personnel Accountability Report (PAR) to ensure all current Users of a LUNAR device are accounted for and responsive. When a PAR Check is initiated in FireGrid, a notification appears on the LUNAR device and the PAR icon is displayed in the status bar.

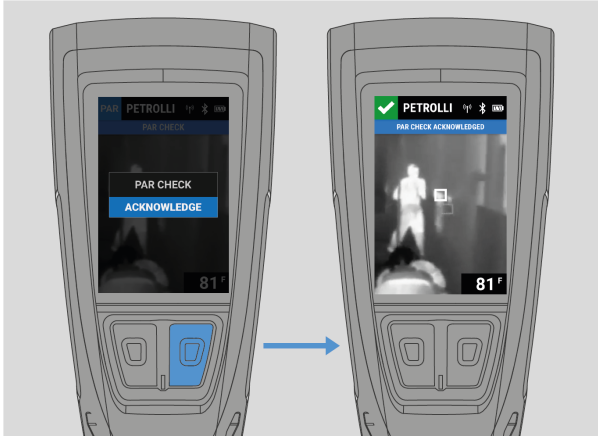

To acknowledge the PAR Check, press the **Enter** button.

NOTE: A PAR Check notification is not displayed if there is an active Manual or Motion alarm on the device. First, [cancel the alarm](#) if it is safe to do so.

5.6 Acknowledging an Evacuate Notification

When an Evacuate notification is initiated, all LUNAR devices on scene receiving the Evacuate notification will be in alarm. The alarm will continue until the evacuation is acknowledged on the LUNAR device or is cancelled by the initiator.

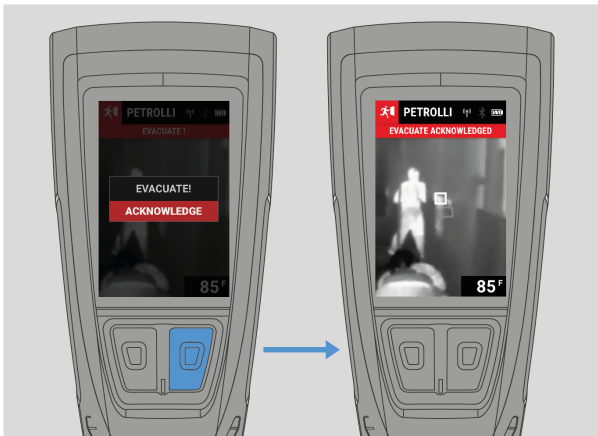

To acknowledge the notification, press the **Enter** button.

NOTE: An Evacuate notification is not displayed if there is an active Manual or Motion alarm on the device. First, [cancel the alarm](#) if it is safe to do so.

6 Learn More

6.1 Support

For technical support, please contact MSA:

Phone: 1-877-MSA-FIRE (1-877-672-3473)

Fax: 1-877-672-3930

Email: fire.cs@msasafety.com

6.2 Specifications

6.2.1 Radio

Radio	Part Number	Power	Frequency Range
Bluetooth	All Part Numbers	≤ 4 dBm	2.400 GHz - 2.4835 GHz
2.4 GHz Radio	FCC Regions	≤ 20 dBm	2.400 GHz - 2.4835 GHz
	ETSI/EN Regions	≤ 10 dBm	2.400 GHz - 2.4835 GHz
Cellular	All Part Numbers	≤ 23 dBm	699 GHz - 787 GHz
		≤ 23 dBm	814 MHz - 862 MHz
		≤ 23 dBm	880 GHz - 915 GHz
		≤ 23 dBm	1.710 MHz - 1.785 MHz
		≤ 23 dBm	1.850 GHz - 1.980 GHz

6.2.2 Ingress Protection Rating

This device has an ingress protection rating of IP 67.

6.2.3 Single-Point Charger International Input AC Power Plugs

The below table is a guideline for suitable AC power plugs for the Single-Point Charger power supply.

- (1) Class II model NEMA 1-15P AC power plug with 2 prongs, Q-NA(R)
- (2) Australian AS 3112 configuration: SAA 2 pins Class II, Q-SAA(R)
- (3) UK BS 1363 configuration: UK 2 pins Class II, Q-UKY(R)
- (4) European CEE 7/16 configuration: Europlug 2 PINS, Class II, Q-EU(R)
- (5) Korean KS C8305 configuration: Q-KR(R)
- (6) Argentina IRAM 2073 configuration: 2 pins, Class II Q-AR(R)
- (7) China GR 2099 configuration: 2 pins, Class II Q-CN(R)
- (8) India configuration: 2 pins, Class II, Q-IN(R)

6.3 Warranty

MSA The Safety Company warrants MSA LUNAR to be free from defects in materials and/or faulty workmanship for a period of two (2) years.

An optional extended warranty is available. For any additional information relative to use or repair, call 1-877-MSA-FIRE (1-877-672-3473) or write an e-mail to fire.cs@msasafety.com.

For additional contact information refer to the MSA website at <http://www.MSAafety.com>.

6.4 Certifications

See device label for the certification that applies to the LUNAR device.

Table 1

UL 121201 Certified to (Gas) Class I, Groups C & D, Division 2, T3
CSA C22.2 No. 213 Certified to (Gas) Class I, Groups C & D, Division 2, T3

WARNING!

Only approved for use in hazardous locations/areas requiring equipment certified to standards as specified in Certifications Table 1.

Do NOT use LUNAR in hazardous locations/areas requiring equipment certification to standards not specified in Certifications Table 1.

Failure to follow these warnings can result in serious personal injury or death.

6.4.1 Certified Temperature Ranges

Certified ambient charging temperature range: 0°C (32°F) $\leq T_{\text{amb}} \leq +40^{\circ}\text{C}$ (104°F).

Certified ambient operating temperature range: -25°C (-13°F) $\leq T_{\text{amb}} \leq +40^{\circ}\text{C}$ (104°F).

6.4.2 Declaration of Conformity

The Declaration of Conformity can be found under the following link: <https://MSAafety.com/DoC>.

6.5 Legal Notices

MSA accepts no liability in cases where the device has been misused, used inappropriately or not used as intended.

MSA accepts no liability in cases where damage or injury is caused by wear and tear, neglect or failure to carry out inspection and maintenance procedures.

The selection and use of the device are the exclusive responsibility of the employer and/or individual operator.

Warranties and guarantees made by MSA with respect to the device are voided, if it is not used, serviced or maintained in accordance with the instructions in this manual.

