



# Masterstream 4000 ER Automatic and Selectable Nozzles

## INSTRUCTION FOR SAFE OPERATION AND MAINTENANCE

### **WARNING**

Understand manual before use. Operation of this device without understanding the manual and receiving proper training is a misuse of this equipment. Obtain safety information at [tft.com/serial-number](http://tft.com/serial-number).

This equipment is intended for use by trained and qualified emergency services personnel for firefighting. All personnel using this equipment shall have completed a course of education approved by the Authority Having Jurisdiction (AHJ).

This instruction manual is intended to familiarize firefighters and maintenance personnel with the operation, servicing, and safety procedures associated with this product. This manual should be kept available to all operating and maintenance personnel.



### **AUTOMATIC**

600 - 4000 GPM @ 80-120 PSI  
(2350 - 15,000 LPM @ 5.5-8.3 BAR)



### **SELECTABLE**

2000, 3000, 4000 GPM @ 100 PSI  
(7500, 11,000, 15,000 LPM @ 7 BAR)

**TASK FORCE TIPS LLC**  
MADE IN USA · [tft.com](http://tft.com)

3701 Innovation Way, Valparaiso, IN 46383-9327 USA  
800-348-2686 · 219-462-6161 · Fax 219-464-7155

# TABLE OF CONTENTS

- 1.0 MEANING OF SAFETY SIGNAL WORDS
- 2.0 SAFETY
- 3.0 GENERAL INFORMATION
  - 3.1 USE WITH SALT WATER
  - 3.2 VARIOUS MODELS AND TERMS
  - 3.3 SPECIFICATIONS
    - 3.3.1 MECHANICAL
  - 3.4 ELECTRIC INSTALLATION
- 4.0 USE WITH FOAM
- 5.0 NOZZLE OPERATION
  - 5.1 PATTERN CONTROL
  - 5.2 AUTOMATIC NOZZLE OPERATION
  - 5.3 SELECTABLE NOZZLE OPERATION
  - 5.4 FLOW SELECTION
- 6.0 FLOW CHARACTERISTICS
  - 6.1 MASTERSTREAM 4000 ER AUTOMATIC
  - 6.2 MASTERSTREAM 4000 ER SELECTABLE
  - 6.3 STREAM TRAJECTORY DATA
- 7.0 FLUSHING DEBRIS
- 8.0 WARRANTY
- 9.0 MAINTENANCE
  - 9.1 FIELD LUBRICATION
  - 9.2 SERVICE TESTING
  - 9.3 REPAIR
- 10.0 EXPLODED VIEW AND PARTS LIST
- 11.0 OPERATION AND INSPECTION CHECKLIST



**PERSONAL RESPONSIBILITY CODE**

The member companies of FEMSA that provide emergency response equipment and services want responders to know and understand the following:

1. Firefighting and Emergency Response are inherently dangerous activities requiring proper training in their hazards and the use of extreme caution at all times.
2. It is your responsibility to read and understand any user's instructions, including purpose and limitations, provided with any piece of equipment you may be called upon to use.
3. It is your responsibility to know that you have been properly trained in Firefighting and/or Emergency Response and in the use, precautions, and care of any equipment you may be called upon to use.
4. It is your responsibility to be in proper physical condition and to maintain the personal skill level required to operate any equipment you may be called upon to use.
5. It is your responsibility to know that your equipment is in operable condition and has been maintained in accordance with the manufacturer's instructions.
6. Failure to follow these guidelines may result in death, burns or other severe injury.



Fire and Emergency Manufacturers and Service Association  
P.O. Box 147, Lynnfield, MA 01940 • www.FEMSA.org

## SUPPORTING MATERIALS

The following documents contain supporting safety and operating information pertaining to the equipment described in this manual.

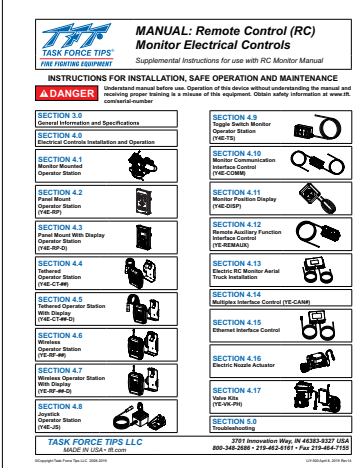

**MANUAL: Remote Control (RC) Monitor Electrical Controls**  
Supplemental Instructions for use with RC Monitor Manual

**INSTRUCTIONS FOR INSTALLATION, SAFE OPERATION AND MAINTENANCE**

**! DANGER**  
Unauthorized removal or use. Operator of this device without understanding the manual and receiving proper training is a misuse of this equipment. Obtain safety information at [www.taskforce-tips.com](http://www.taskforce-tips.com)

<b>SECTION 4.0</b> General Information and Specifications	<b>SECTION 4.8</b> Toggle Switch Monitor Operator Station (YVE-TS)
<b>SECTION 4.1</b> Monitor Monitor Operator Station (YVE-MO)	<b>SECTION 4.10</b> Monitor Communication Monitor Control (YVE-COMM)
<b>SECTION 4.2</b> Panel Mount Operator Station (YVE-PM)	<b>SECTION 4.11</b> Monitor Position Display (YVE-OSDP)
<b>SECTION 4.3</b> Panel Mount With Display Operator Station (YVE-PM-D)	<b>SECTION 4.12</b> Remote Auxiliary Monitor Position Interface Control (YVE-RAIM)
<b>SECTION 4.4</b> Subpanel Operator Station (YVE-CT-SP)	<b>SECTION 4.13</b> Electric RC Monitor Aerial Truck Installation (YVE-AT)
<b>SECTION 4.5</b> Vehicle Operator Station With Display (YVE-CT-SP-D)	<b>SECTION 4.14</b> Multiplex Interface Control (YVE-CAM)
<b>SECTION 4.6</b> Remote Operator Station (YVE-RO)	<b>SECTION 4.15</b> External Interface Control (YVE-EIC)
<b>SECTION 4.7</b> Vehicle Operator Station With Display (YVE-RO-D)	<b>SECTION 4.16</b> Electric Nozzle Actuator (YVE-NA)
<b>SECTION 4.8</b> Operator Station (YVE-OS)	<b>SECTION 4.17</b> Video Kit (YVE-VK)
	<b>SECTION 5.0</b> Troubleshooting

TASK FORCE TIPS, LLC  
3700 International Hwy, St. Albans, VT 05478 USA  
800-348-2688 • 219-463-6161 • Fax 219-464-7155

LIY-500 Remote Control (RC) Monitor Electrical Controls

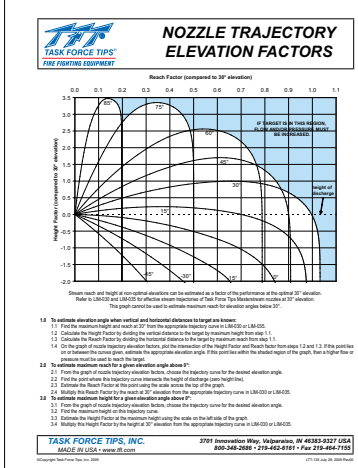

**NOZZLE TRAJECTORY ELEVATION FACTORS**

Reach Factor (assumes 30° elevation)

Height Factor (assumes 30° elevation)

Range (feet) and height at 30° elevation can be estimated as a factor of the performance of the listed 30° elevation nozzle. Use the 30° elevation nozzle to estimate nozzle reach for elevation angles below 30°.





1.0 To estimate elevation angle when vertical and horizontal distances to target are known:  
 1.1 Find the maximum height and reach of 30° from the appropriate trajectory curve in table 1.  
 1.2 Calculate the Height Factor by dividing the vertical distance to the target by maximum height from step 1.1.  
 1.3 Calculate the Reach Factor by dividing the horizontal distance to the target by maximum reach from step 1.1.  
 1.4 On the graph of nozzle trajectory elevation factors, plot the intersection of the Height Factor and Reach Factor from steps 1.2 and 1.3. The point where the curves intersect is the elevation angle.  
 2.0 To estimate maximum reach for a given elevation angle above 30°:  
 2.1 On the graph of nozzle trajectory elevation factors, choose the trajectory curve for the desired elevation angle.  
 2.2 Find the point where the trajectory curve intersects the height of discharge (see height factor).  
 2.3 Estimate the Reach Factor at this point along the scale across the top of the graph.  
 2.4 Multiply the Reach Factor by the 30° elevation nozzle performance (reach) to estimate the maximum reach.  
 3.0 To estimate maximum height for a given elevation angle above 30°:  
 3.1 On the graph of nozzle trajectory elevation factors, choose the trajectory curve for the desired elevation angle.  
 3.2 Find the maximum height on the trajectory curve.  
 3.3 Estimate the Height Factor at the maximum height using the scale on the left side of the graph.  
 3.4 Multiply the Height Factor by the height of 30° elevation from the appropriate trajectory curve in table 1 to estimate the maximum height.

TASK FORCE TIPS, INC.  
3700 International Hwy, Waterbury, VT 05671 USA  
800-348-2688 • 219-463-6161 • Fax 219-464-7155









LTT-135 Nozzle Trajectory Elevation Factors

## 1.0 MEANING OF SAFETY SIGNAL WORDS

A safety related message is identified by a safety alert symbol and a signal word to indicate the level of risk involved with a particular hazard. Per ANSI Z535.6, the definitions of the four signal words are as follows:

	<b>DANGER</b> indicates a hazardous situation which, if not avoided, will result in death or serious injury.
	<b>WARNING</b> indicates a hazardous situation which, if not avoided, could result in death or serious injury.
	<b>CAUTION</b> indicates a potentially hazardous situation which, if not avoided, could result in minor or moderate injury.
	<b>NOTICE</b> is used to address practices not related to physical injury.

## 2.0 SAFETY

	An inadequate supply of pressure and/or flow will cause an ineffective stream and can result in injury or death. Choose operating conditions to deliver adequate fire suppression. See flow graphs.
	This equipment is intended for use by trained personnel for firefighting. Use of this equipment for other purposes may involve hazards not addressed by this manual. Seek appropriate guidance and training to reduce risk of injury.
	The stream exiting a nozzle is very powerful and capable of causing injury and property damage. Make sure the nozzle is securely attached and pointing in a safe direction before water is turned on. Do not direct water stream to cause injury or damage to persons or property.
	Inadequately supported nozzle reaction force can result in injury or death. The mounting must be capable of supporting the maximum nozzle reaction force as stated in the nozzle's manual.
	Equipment may be damaged if frozen while containing significant amounts of water. Such damage may be difficult to detect visually. Subsequent pressurization can lead to injury or death. Any time the equipment is subject to possible damage due to freezing, it must be tested and approved for use by qualified personnel before being considered safe for use.
	Application of water or foam solutions on energized electrical equipment could cause electrocution. Serious injury or death could result. Assume circuits are energized until confirmed to be de-energized. Do not apply water or foam to energized electrical equipment.
	Mismatched or damaged waterway connections may cause equipment to leak or uncouple under pressure. Failure could result in injury. Equipment must be mated to matched connections.
	Dissimilar metals coupled together can cause galvanic corrosion that can result in the inability to uncouple the connection, or complete loss of engagement over time. Failure could cause injury. Per NFPA 1962, if dissimilar metals are left coupled together, an anti-corrosive lubricant should be applied to the connection and the coupling should be disconnected and inspected at least quarterly.

### 3.0 GENERAL INFORMATION

The Task Force Tips Masterstream 4000 ER Series deluge nozzles have a clean, far reaching straight stream capability and are available with automatic pressure control or selectable gallonage. While flowing, the stream pattern can be varied from wide fog to straight stream. Trapped debris can be removed without the use of tools.

These nozzles are constructed of hardcoat anodized aluminum. Their rugged construction is compatible with the use of fresh water and firefighting foam solutions. A summary of each nozzle's characteristics is shown in the table below.

	FLOW RANGE		NOMINAL PRESSURE		COUPLING OPTIONS	
	GPM	L/min	PSI	BAR, kPa/100		
<b>AUTOMATIC</b>	600 - 4000	2350 - 15,000	80-120	5.5 - 8.3	6" ANSI FLANGE	7" TSUNAMI QUICK CONNECT
<b>SELECTABLE</b>	2000, 3000, 4000	7500, 11,000, 15,000	100	7		

Table 3.0

- Master 4000 nozzles are field adjustable within the ranges shown.
- For long term installations, it is recommended that the threads be greased with a waterproof lubricant such as Molykote #112 Silicone Grease before installing the nozzle.

### 3.1 USE WITH SALT WATER

Use with salt water is permissible provided the equipment is thoroughly cleaned with fresh water after each use. The service life of the equipment may be shortened due to the effects of corrosion, and is not covered under warranty.

### 3.2 VARIOUS MODELS AND TERMS

The Masterstream 4000 ER nozzle is available in several different models and inlet connections. Basic body styles are shown below.

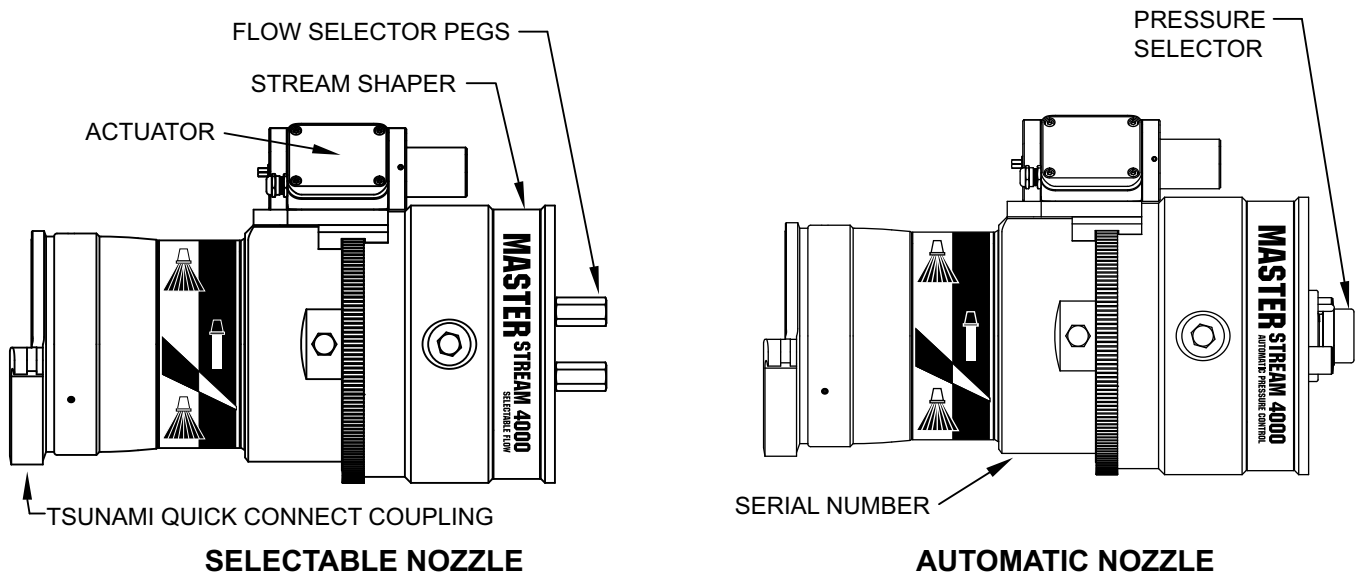

Figure 3.2

### 3.3 SPECIFICATIONS

#### 3.3.1 MECHANICAL

	US	METRIC
Weight	59 lb	27 kg
Maximum operating pressure	175 psi	12 bar
Maximum fog angle	110°	110°
Operating temperature range of fluid	33 to 120°F	1 to 50°C
Storage temperature range	-40 to 150°F	-40 to 65°C
Materials used	Aluminum 6000 series hard anodized MIL8625 class 3 type 2, stainless steel 300 series, nylon 6-6, nitrile rubber	

Table 3.3.1

### 3.4 ELECTRIC INSTALLATION

For nozzle installation, refer to LIY-500 Remote Control (RC) Monitor Electrical Controls (shipped with TFT monitors or available at tft.com).



**This device is not rated as ignition proof, explosion proof, or intrinsically safe. Use only in locations with adequate ventilation and no hazard of flammable vapor buildup.**

### 4.0 USE WITH FOAM

The nozzle may be used with foam solutions. Refer to fire service training by the Authority Having Jurisdiction (AHJ) for the proper use of foam.



**For Class B fires, lack of foam or interruption in the foam stream can cause a break in the foam blanket and greatly increase the risk of injury or death. Follow procedures established by the AHJ for the specific fuel and conditions.**



**Improper use of foam or using the wrong type of foam can result in illness, injury, or damage to the environment. Follow foam manufacturer's instructions and fire service training as directed by the AHJ.**

### 5.0 NOZZLE OPERATION

#### 5.1 PATTERN CONTROL

TFT nozzles have full pattern control from straight stream to wide fog. Turning the stream shaper clockwise (as seen from the operating position behind the nozzle) moves the shaper to the straight stream position.

Press and hold the FOG or STRAIGHT STREAM buttons on the nozzle controls to move the stream shaper. Release the button when the desired pattern is reached.

Since the stream trim point varies with flow, the stream should be "trimmed" after changing the flow to obtain the straightest and farthest reaching stream. To properly trim the stream, first open the pattern to narrow fog. Then close the stream to parallel to give maximum reach. Turning the shaper further forward will cause stream crossover and reduce the effective reach of the nozzle.



**Dents or nicks in the nozzle tip can seriously affect the stream reach or pattern, which may increase the risk of injury due to exposure. Care must be taken to avoid dents or nicks in the nozzle tip.**

## 5.2 AUTOMATIC NOZZLE OPERATION

Automatic nozzles operate by sensing the pressure at the nozzle's inlet and adjusting the discharge opening to maintain a constant pressure throughout the flow range of the nozzle. For example, when the pressure at the inlet increases, the exit area is automatically increased until the inlet pressure returns to the nominal pressure of the nozzle.

### NOTICE

**Inlet pressure of a Masterstream ER automatic nozzle will stabilize at the nominal pressure within 5%. This stabilization may take as long as half a minute after a change in inlet pressure.**

## 5.3 SELECTABLE NOZZLE OPERATION

A selectable nozzle has several discharge orifices that can be set to a user selected position. In each position the nozzle acts as a fixed orifice nozzle.

## 5.4 FLOW SELECTION

The Master 4000 ER selectable nozzle utilizes two stainless steel pegs to set the flow rate.

To change flow rate:

1. Remove the flow selector pegs from the baffle cap by unthreading them counter-clockwise.
2. Rotate the gallonage selector until the indicator windows align with the desired flow.
3. Thread the flow selector pegs into the counter-bored holes in the baffle cap aligned with holes in the gallonage selector until hand tight.

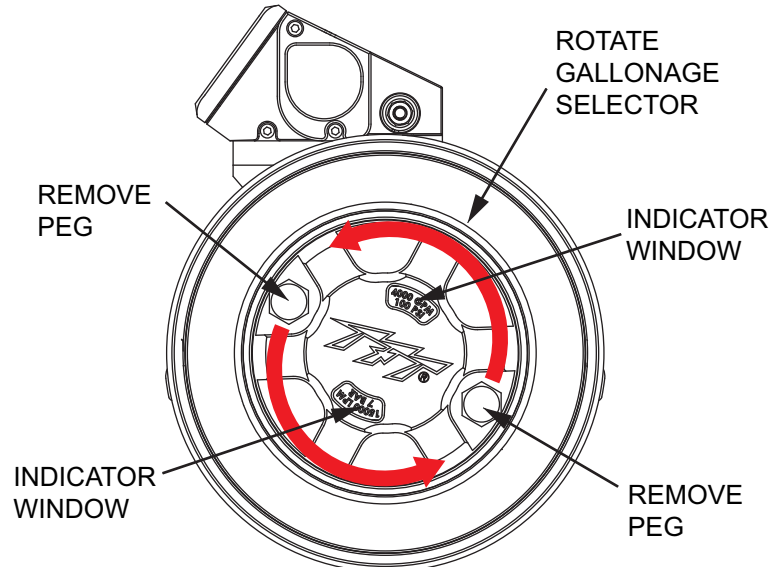

Figure 5.4

## 6.0 FLOW CHARACTERISTICS

### 6.1 MASTERSTREAM 4000 ER AUTOMATIC

Within its flow range, the Masterstream 4000 ER automatic nozzle operates at the nominal pressure of 80-120 PSI (5.5-8.3 BAR, 550-830 kPa). The following chart shows the typical performance of this nozzle.

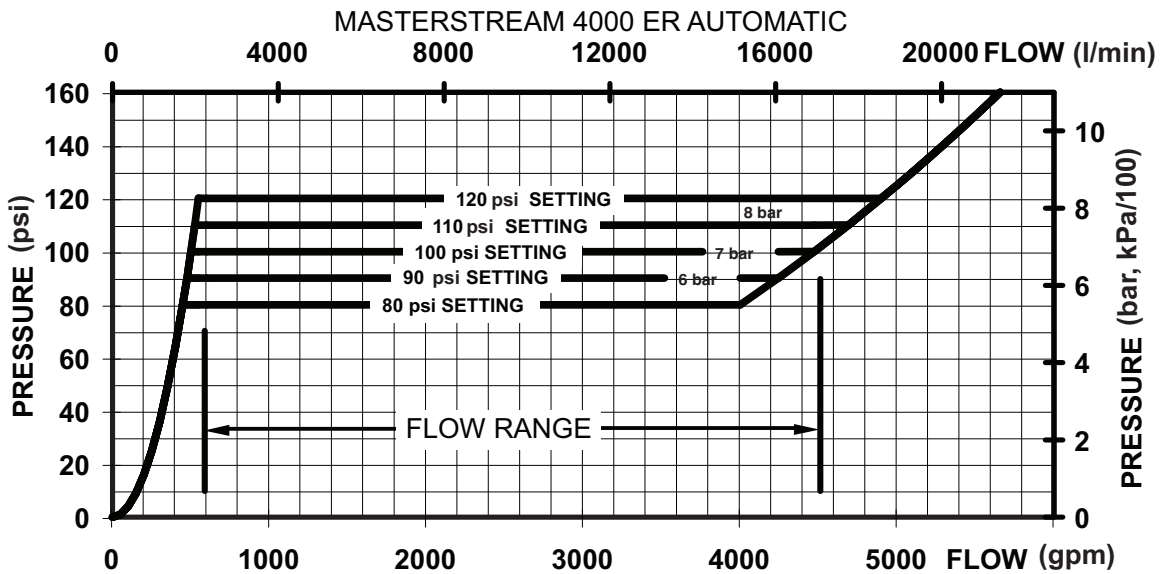

Figure 6.1

### 6.2 MASTERSTREAM 4000 ER SELECTABLE

The Masterstream 4000 ER Selectable nozzle allows the user to select one of several orifice sizes to achieve desired flows at the rated pressure of the nozzle. The following chart gives relationship of flow and pressure for the various orifice sizes.

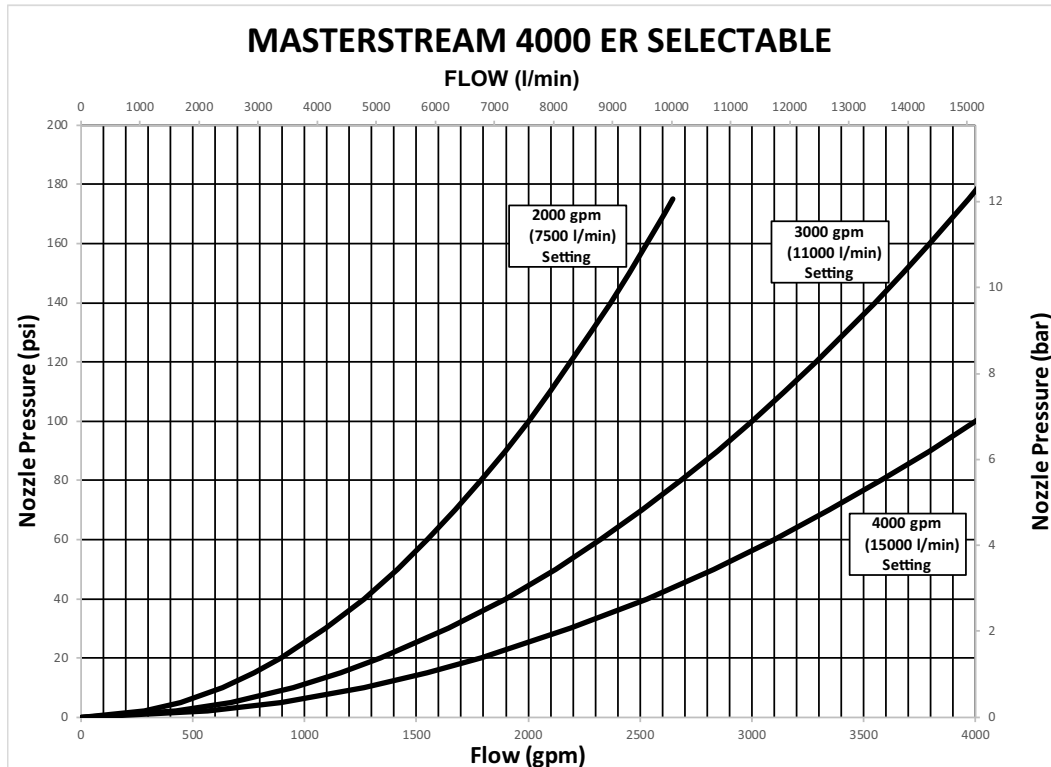

Figure 6.2

### 6.3 STREAM TRAJECTORY DATA

The tables and graphs in this section give the stream trajectory for the Masterstream 4000 ER Series nozzles at various flows.

Notes on trajectory graphs:

- Graphs show approximate effective stream trajectory at 30 degrees elevation in no wind conditions. Distance to last water drops approximately 10% farther.
- To estimate trajectories at elevations other than 30 degrees, refer to document LTT-135, available at tft.com.
- Trajectories shown are for water. The addition of foam is expected to decrease the reach by 10%.
- Tail or head winds of 20 MPH (30 KPH) may increase or decrease the range approximately 30%.
- Stream trajectory of Masterstream 4000 based on "The Trajectories of Large Fire Fighting Jets" by A.P. Hatton and M.J. Osborne, Reference: "The International Journal of Heat and Fluid Flow", Vol 1 No 1.
- Curves C, D, and E represent trajectory data for the 2000, 3000, and 4000 settings of the 100 psi selectable nozzle.

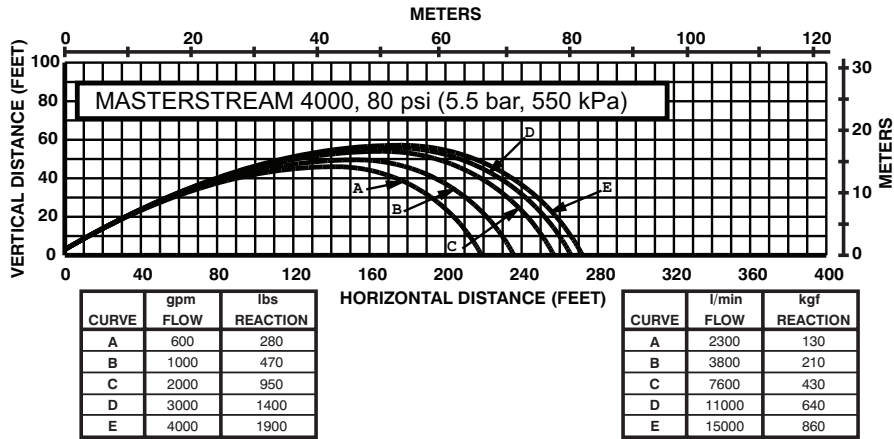

Figure 6.3A

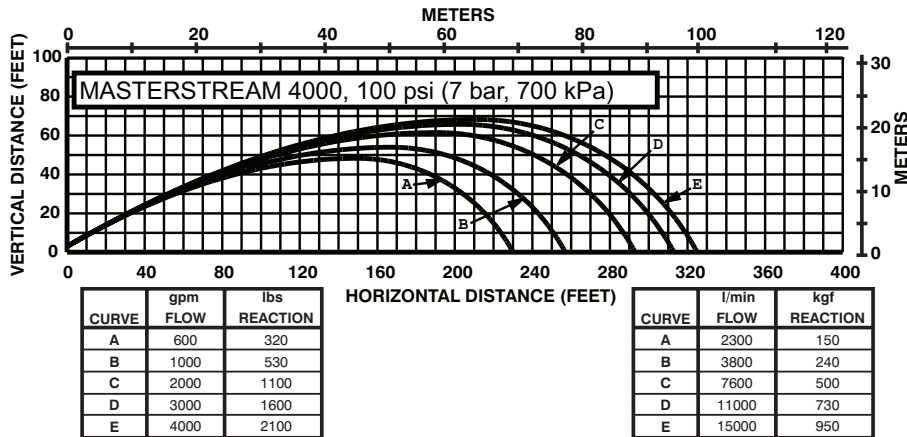

Figure 6.3B

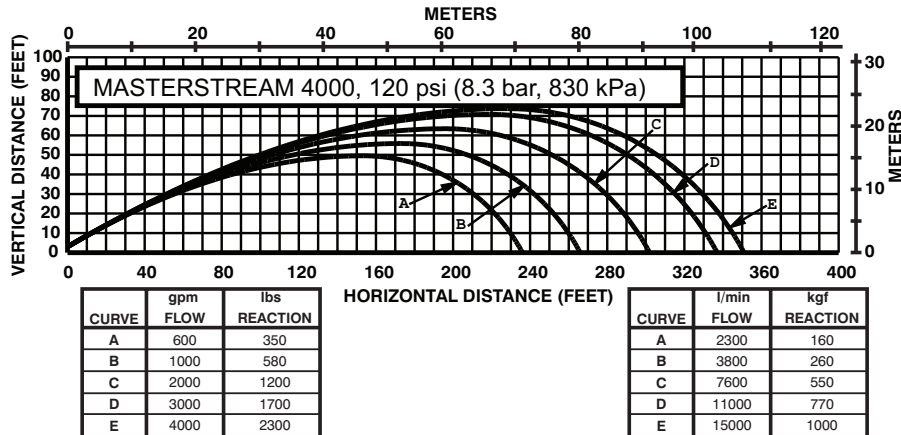

Figure 6.3C



## 7.0 FLUSHING DEBRIS

Debris in the water may get caught inside the nozzle. This trapped material will cause poor stream quality, shortened reach and reduced flow. To remove debris trapped in the nozzle:

1. Shut off flow to the nozzle
2. Move the stream shaper to the wide fog position
3. Carefully unscrew and remove the baffle and orifice control components
4. Remove/flush debris
5. Reassemble the nozzle

Figure 7.0 shows the pieces that are removed during the flush procedure for automatic and selectable nozzles.



**Large amounts or pieces of debris may be unflushable and can reduce the flow of the nozzle resulting in an ineffective flow. In the event of a blockage, it may be necessary to retreat to a safe area, uncouple the nozzle and remove debris.**

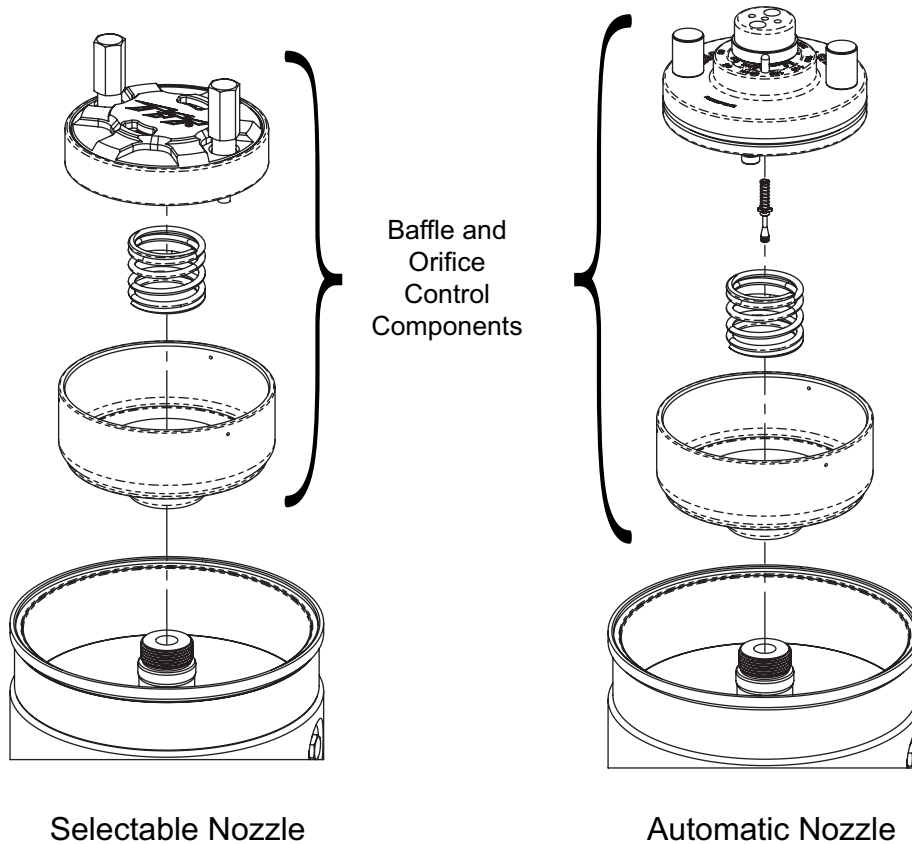

Figure 7.0

## 8.0 WARRANTY

Task Force Tips LLC, 3701 Innovation Way, Valparaiso, Indiana 46383-9327 USA ("TFT") warrants to the original purchaser of its products ("equipment"), and to anyone to whom it is transferred, that the equipment shall be free from defects in material and workmanship during the five (5) year period from the date of purchase. TFT's obligation under this warranty is specifically limited to replacing or repairing the equipment (or its parts) which are shown by TFT's examination to be in a defective condition attributable to TFT. To qualify for this limited warranty, the claimant must return the equipment to TFT, at 3701 Innovation Way, Valparaiso, Indiana 46383-9327 USA, within a reasonable time after discovery of the defect. TFT will examine the equipment. If TFT determines that there is a defect attributable to it, TFT will correct the problem within a reasonable time. If the equipment is covered by this limited warranty, TFT will assume the expenses of repair.

If any defect attributable to TFT under this limited warranty cannot be reasonably cured by repair or replacement, TFT may elect to refund the purchase price of the equipment, less reasonable depreciation, in complete discharge of its obligations under this limited warranty. If TFT makes this election, claimant shall return the equipment to TFT free and clear of any liens and encumbrances.

This is a limited warranty. The original purchaser of the equipment, any person to whom it is transferred, and any person who is an intended or unintended beneficiary of the equipment, shall not be entitled to recover from TFT any consequential or incidental damages for injury to person and/or property resulting from any defective equipment manufactured or assembled by TFT.

It is agreed and understood that the price stated for the equipment is in part consideration for limiting TFT's liability. Some states do not allow the exclusion or limitation of incidental or consequential damages, so the above may not apply to you.

TFT shall have no obligation under this limited warranty if the equipment is, or has been, misused or neglected (including failure to provide reasonable maintenance) or if there have been accidents to the equipment or if it has been repaired or altered by someone else.

**THIS IS A LIMITED EXPRESS WARRANTY ONLY. TFT EXPRESSLY DISCLAIMS WITH RESPECT TO THE EQUIPMENT ALL IMPLIED WARRANTIES OF MERCHANTABILITY AND ALL IMPLIED WARRANTIES OF FITNESS FOR A PARTICULAR PURPOSE. THERE IS NO WARRANTY OF ANY NATURE MADE BY TFT BEYOND THAT STATED IN THIS DOCUMENT.**

This limited warranty gives you specific legal rights, and you may also have other rights which vary from state to state.

## 9.0 MAINTENANCE

TFT nozzles are designed and manufactured to be damage resistant and require minimal maintenance. However, as the primary firefighting tool upon which your life depends, it should be treated accordingly. Do not drop or throw equipment.

When reassembling the automatic nozzles after repairs or for preventive maintenance, coat the seal on the piston, the inner bore of the cylinder and the shaft slide surface with a waterproof lubricant such as Molykote #112 Silicone Grease. Lubrication is required to assure continued smooth operation. The frequency of lubrication will depend on frequency of usage and storage conditions. Nozzles must be checked regularly to assure proper operation.

Contact factory for parts lists and exploded views for particular models. Each nozzle is identified by a serial number located on the nozzle's stream shaper.

### 9.1 FIELD LUBRICATION

All Task Force Tips nozzles are factory lubricated with high quality silicone grease. This lubricant has excellent wash out resistance, providing long term performance in firefighting nozzles. If your agency has unusually hard or sandy water, the moving parts of the nozzle may be affected. Foam agents and water additives contain soaps and chemicals that may break down the factory lubrication.

The moving parts of the nozzle should be checked on a regular basis for smooth and free operation, and for signs of damage. IF THE NOZZLE IS OPERATING CORRECTLY, THEN NO ADDITIONAL LUBRICANT IS NEEDED. Any nozzle that is not operating correctly should be immediately removed from service. The nozzle can be returned to the factory at any time for a complete checkup and re-lubrication with silicone grease.

The field use of Break Free CLP (spray or liquid) lubricant will help to temporarily restore the smooth and free operation of the nozzle. These lubricants do not have the washout resistance and long-term performance of the silicone grease. Once Break Free CLP is applied, re-application will be needed on a regular basis until the nozzle can be returned to the factory for a complete checkup and re-lubrication with silicone grease.



**Aerosol lubricants contain solvents that can swell O-Rings if applied in excess. The swelling can inhibit smooth operation of the moving parts. When used in moderation, as directed, the solvents quickly evaporate without adversely swelling the O-Rings.**

### 9.2 SERVICE TESTING

In accordance with NFPA 1962, equipment must be tested a minimum of annually. Units failing any part of this test must be removed from service, repaired and retested upon completion of the repair.

### 9.3 REPAIR

Factory service is available with repair time seldom exceeding one day in our facility. Factory serviced equipment is repaired by experienced technicians, wet tested to original specifications, and promptly returned. Any returns should include a note as to the nature of the problem and whom to reach in case of questions.

Repair parts and service procedures are available for those wishing to perform their own repairs. Task Force Tips assumes no liability for damage to equipment or injury to personnel that is a result of user service. Contact the factory or visit the web site at [tft.com](http://tft.com) for parts lists, exploded views, test procedures and troubleshooting guides.

Performance tests shall be conducted on the equipment after a repair, or anytime a problem is reported to verify operation in accordance with TFT test procedures. Consult factory for the procedure that corresponds to the model and serial number of the equipment. Any equipment which fails the related test criteria should be removed from service immediately. Troubleshooting guides are available with each test procedure or equipment can be returned to the factory for service and testing.



**Any alterations to the product or its markings could diminish safety and constitutes a misuse of this product.**



**All replacement parts must be obtained from the manufacturer to assure proper operation of the device.**

## 10.0 EXPLODED VIEW AND PARTS LIST

Exploded views and parts lists are available at [tft.com/serial-number](http://tft.com/serial-number).

## 11.0 OPERATION AND INSPECTION CHECKLIST

**BEFORE EACH USE**, the nozzle must be inspected to this checklist:

1. There is no obvious damage such as missing, broken or loose parts, damaged labels etc.
2. Debris screen is free of debris
3. Coupling is tight and leak free
4. Nozzle operates freely through full range and regulates flow
5. Nozzle flow is adequate as indicated by pump pressure and nozzle reaction
6. Shaper turns freely and adjusts pattern through full range
7. Shaper detent (if so equipped) operates smoothly and positively.

**BEFORE BEING PLACED BACK IN SERVICE**, nozzles must be inspected to this checklist:

1. All controls and adjustments are operational
2. Shut off valve (if so equipped) closes off the flow completely
3. There are no broken or missing parts
4. There is no damage to the nozzle that could impair safe operation (e.g. dents, cracks, corrosion or other defects)
5. The thread gasket is in good condition
6. The waterway is clear of obstructions
7. Nozzle is clean and markings are legible
8. Coupling is retightened properly
9. Shaper is set to desired pattern

*NFPA 1962: Standard for the care, use, inspection, service testing, and replacement of fire hose, couplings, nozzles and fire hose appliances. Quincy, MA: National Fire Protection Agency*



**Equipment failing any part of the checklist is unsafe for use and must have the problem corrected before use or being placed back into service. Operating equipment that has failed the checklist is a misuse of this equipment.**