

Thank you for your purchase of this Coin-operated Massage Chair

(massage chair). Please read this USER MANUAL carefully and pay special attention to the safety precaution to ensure proper use.

Please refer to the Nomenclature for further reference.

## CONTENTS

- SAFETY PRECAUTIONS-----
- DESCRIPTION AND FEATURES-----
- OPERATION AND FUNCTION OF EACH PART-----
- OPERATION METHOD-----
- INSTALLATION METHOD-----
- OPERATION BEFORE USE-----
- PRODUCT STORAGE AND MAINTENANCE-----
- TRUBLE SHOOTING-----
- TECHNICAL SPECIFICATIONS-----

## TRUBLE SHOOTING

Phenomenas	Reasons	Solutions
No display after starting	If plug is inserted to the socket?	Plug into the socket.
	If power switch behind the armis cut?	Switch on the power.
	If the fuse is burnt?	Replace the fuse.
Stop working suddenly	If the back cushion touches on the wall or other obstacles?	To avoid collision, please shut off the power switch ,move the machine, turn on the power switch again.
	Is the user heavy? (For safety, the massage mechanism will stop working when the user exceeds the weight limit.)	Let the body to leave the back cushion temporarily, shut off the power switch , after turn on the switch again to press the function button. All start again.
Red light flashes at the inserting place	If the cash box is full?	Take out the money, and restart the machine
screen show Err1	Massage mechanism can not return to original state.	Check the massage chair, try it again after powered on . If it can not be recovered, the massage chair should be sent for repair.
screen show Err2	If the current is unstable?	Try it again after shutting off the power for 5 seconds.

If you make the above disposal, massage chairs still has questions, please contact the dealer.

## TECHNICAL SPECIFICATIONS

Product name: Bill-operated Massage Chair  
 Model: RT-M12A  
 Rated voltage: 110-120V~  
 Rated frequency: 60 Hz  
 Rated power: 100W

## ▶ PRODUCT STORAGE AND MAINTENANCE

### Maintenance method

#### Main unit

To clean the plastic, pipe and armrest with cotton fabric dipped with neutral detergent, then use dry cloth to clean them carefully.

#### Caution



Do not use the corrosive fluid like alcohol or cleaning powder to clean the massage chair, otherwise, the color of upholstery will fade or the massage chair will crack or be eroded.

#### Controller

Use the dry cloth to wipe off the dirty on the controller.

#### Caution



Do not clean the controller with wet towel to avoid malfunction.

#### Back cushion and pillow

Clean the back cushion and pillow firstly with a piece of cloth that has been dipped with neutral detergent, then use wet cloth to clean them, and finally put them in a well ventilated area.

#### Caution



Do not place the massage chair under direct sunlight for long time, or near the high temperature sources, such as a stove, to avoid color change or deterioration.

### Storage method

Please put the massage chair in a dry place after cleaning the dust, and cover it if it is not to be used for a long period of time.

### Check

 During daily use, please be sure to check	whether the massage chair has following symptoms: a smell of burning; when wire is touched, power is on, but sometimes not; power cord is overheating; other abnormal conditions.	To prevent malfunction and accidents, please pull out the power plug from the socket and contact the dealer from whom you purchased the product or our company. Please do not disassemble it by yourself.
--	---	---

## ▶ SAFETY PRECAUTIONS

### Safety precautions

- ▶ Before use, please read this “SAFETY PRECAUTIONS” carefully to ensure proper operation.
- ▶ The following “SAFETY PRECAUTIONS” is of great help to your correct use of this massage chair.
- ▶ To clearly indicate the degrees of danger and damage, the classes of accidents caused by incorrect use are classified into “WARNING” and “CAUTION”, so everyone must abide by it.







<b>WARNING</b>	Indicating the user may be seriously injured once the massage chair is improperly used.
<b>CAUTION</b>	Indicating the user may be injured or the massage chair may be damaged once the product is improperly used.
	The symbol  indicates the behaviors are prohibited. The detailed contents are described in following charts. (For example: left symbol indicates NO DISASSEMBLY.)
	The symbol  indicates the behaviors are mandatory and must be abided by. The detailed contents are described in following charts. (For example: left symbol indicates REMOVE PLUG.)

### WARNING

 <b>MANDATORY</b>	We recommend that those with any of the following conditions consult a doctor before use. <table border="0" style="width: 100%;"> <tr> <td style="vertical-align: top;">                     1. Those who are using electronic medical instrument imbedded in the body, such as cardiac pacemaker etc.                      2. Those who are being treated by doctors, especially those who feel uncomfortable.                      3. Those who are malignant tumor patients, heart disease patients, acute patients.                      4. Women who are pregnant or menstruating.                 </td> <td style="vertical-align: top;">                     5. Those with osteoporosis or fracture spine.                      6. Those with high blood pressure caused by diabetes or some other diseases.                      7. Those with skin disease on feet or those whose skins are injured.                      8. Those whose body temperature is over 38 degrees (Febrile Phase).                 </td> </tr> </table>	1. Those who are using electronic medical instrument imbedded in the body, such as cardiac pacemaker etc. 2. Those who are being treated by doctors, especially those who feel uncomfortable. 3. Those who are malignant tumor patients, heart disease patients, acute patients. 4. Women who are pregnant or menstruating.	5. Those with osteoporosis or fracture spine. 6. Those with high blood pressure caused by diabetes or some other diseases. 7. Those with skin disease on feet or those whose skins are injured. 8. Those whose body temperature is over 38 degrees (Febrile Phase).
1. Those who are using electronic medical instrument imbedded in the body, such as cardiac pacemaker etc. 2. Those who are being treated by doctors, especially those who feel uncomfortable. 3. Those who are malignant tumor patients, heart disease patients, acute patients. 4. Women who are pregnant or menstruating.	5. Those with osteoporosis or fracture spine. 6. Those with high blood pressure caused by diabetes or some other diseases. 7. Those with skin disease on feet or those whose skins are injured. 8. Those whose body temperature is over 38 degrees (Febrile Phase).		
 <b>PROHIBITED</b>	Always supervise the use of this massage chair by young children or the infirm and make sure that the massage chair cannot be used unsupervised by young children. Do not allow children play on massage chair. Do not allow more than one person to use this massage chair at a time. If the power cord or power plug becomes damaged in any way you must disconnect from the mains supply immediately and consult an authorized service engineer for repair or replacement. Do not damage, process, excessively bend, pull hard, twist or knot power cord.		
 <b>NO DISASSEMBLY</b>	Anyone else, except mainten		

## ▶ SAFETY PRECAUTIONS

### ⚠ CAUTION

 <b>MANDATORY</b>	Please do not continuously use the massage chair over 20 minutes, and it is limited to massage a particular part of body in 5 minutes.
	Please put the massage chair on flat ground for use.
	When adjusting the legrest or backrest, please do not exert excessive force on it, in addition, keep children and pets well clear.
	When removing power plug, please hold the insulation plug, do not pull power cord.
	Please do not use the power supply that is beyond the specified electric voltage, as this may cause fire disaster or damage massage chair.
 <b>PROHIBITED</b>	Before use, please uncover the back cushion to check whether backrest or fabric is damaged; if damaged, please stop using this massage chair immediately, and contact franchiser for repair immediately.
	Please do not operate the controller with damp hands, and do not put heavy objects on controller.
	Please do not pull hard fabric, or stab it with knife or sharp objects.
 <b>REMOVE PLUG</b>	Please do not use other therapeutic equipments together with this massage chair.
	During use, if you feel uncomfortable, please stop use immediately and consult your doctor.
	Do not use the massage chair in damp environment to avoid electric leakage or electric shock.
	Do not place the massage chair near stove or where it will be exposed to strong sunlight for long periods as this may damage the leather and bleach the color.
	The massage chair is equipped with heating function, so people who are insensitive to heat must use it carefully.
 <b>REMOVE PLUG</b>	To avoid causing discomfort, do not use the massage chair immediately after meals.
	Do not fall into sleep on massage chair, when the massage chair is working.
	Do not use the massage chair when you are drunk or feel bad.
	Before use, please be sure to take off watch, bracelet and some other accessories, and be sure to have taken out mobile phone, keys, knife, and some other valuables from your pocket.
	Do not sit on backrest, legrest, or armrest to avoid accidental injury or machine fault.
 <b>REMOVE PLUG</b>	Please do not smoke whilst using the massage chair.
	Before maintenance, please pull out power plug. In addition, please do not insert or unplug the power plug with damp hands, to avoid electric shock.
 <b>REMOVE PLUG</b>	When the massage chair is not in use, please switch off power and remove the plug from the mains socket. When power is off, please cut off power supply immediately and pull out the power plug from socket.

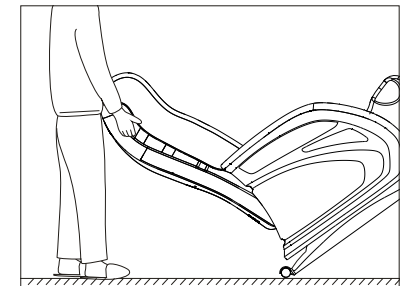
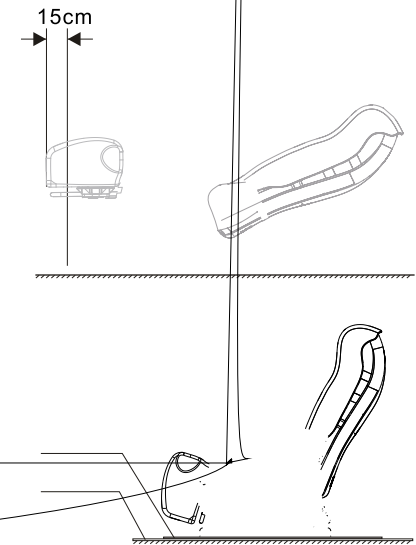

## ▶ INSTALLATION METHOD

### Backrest Installing/Folding Method

Hold up the backrest by 115° in the direction of arrow mark; the backrest is locked when a reminding sound “Ka” is heard.

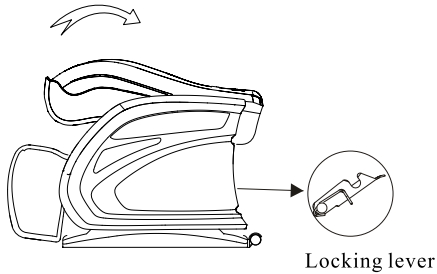

Unfasten the locking levers situated under backrest and on the seat, then fold backrest forward in the direction of arrow mark until it touches the seat cushion.

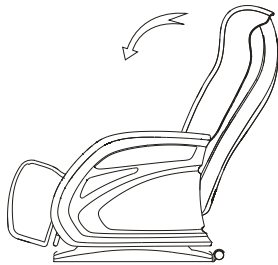

### Back cushion disassembling method

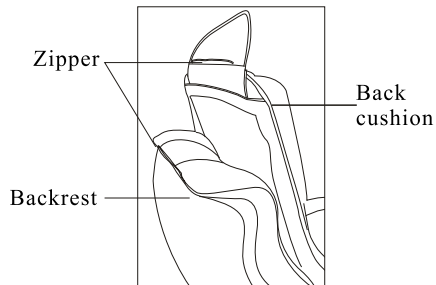

### Seat cushion disassembling method

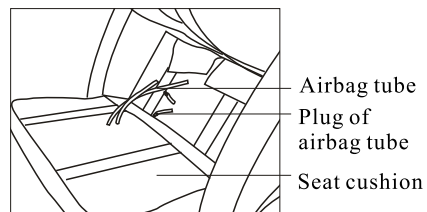

## ▶ FUNCTION AND FEATURES

1. The back moving up and down unit can fit the body curve automatically; the ergonomically design offers the best massage effect; a coin acceptor is installed in the armrest.



2. Delicate massage features provide for humanistic and overall enjoyable massage effect. The back massage unit can move up and down between neck, shoulder, back and waist performing “knead”, “pummel”, “shiatsu” and “wavelet” massages; meanwhile, the massage speed and width are adjustable.

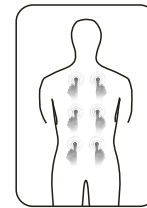

KNEAD

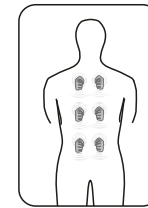

PUMMEL

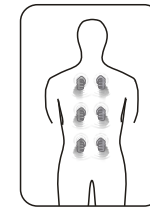

WAVELET

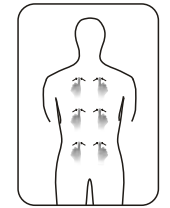

SHIATSU

3. Airbags at lower body perform “wavy” massage; while airbags at the thigh, buttocks and legs areas will be inflated and deflated alternatively offering repeated air pressure massage.

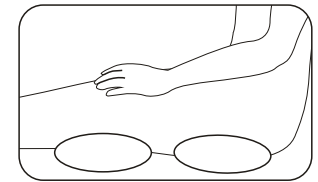

Airbags for massaging thigh and buttocks

4. Airbags installed at up and down sides of left and right legrests provide for alternate and circulatory massage with the airbags installed at the middle of legrest.

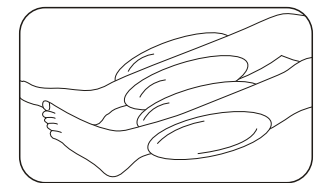

Airbags for massaging leg

## NAME AND FUNCTION OF EACH PART

### External structure

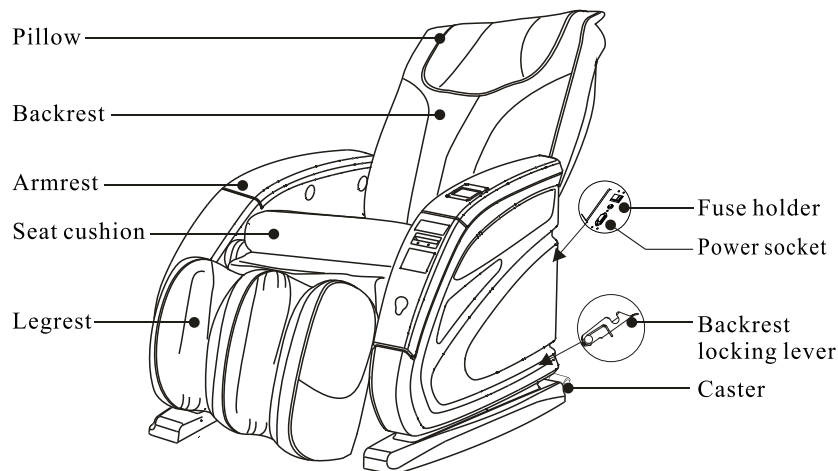

### Internal structure

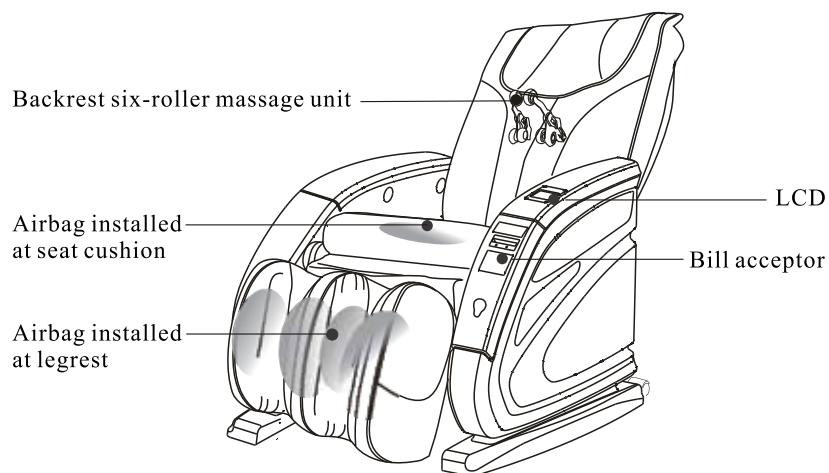

## USE METHOD

### OPERATION STEPS

#### Power on

- Insert the plug into fine grounding three core wire power socket.
- Switch the power on.(behind the backrest)

#### Self-inspection

The bill acceptor massage chair box enters into the self-inspection state after it is powered.  
If the self-inspection is normal, it will go into standby state. Now the parameters can be set.

If the self-inspection is abnormal, there are the following three display:

- Err0 internal communication is abnormal.
- Err1 massage mechanism reposition is abnormal.
- Err2 bill acceptor initialization is abnormal.

Abnormal phenomena : refer to the “troubleshooting” .

#### Bill-insertion

When the massage chair in the standby state, the bills can be inserted. When the quantity of the inserted bills are less than the set starting quantity, the display screen will show the current bill quantity, when the bill quantity is equal to the setting quantity, the machine starts to show the corresponding running time. If no more bills are inserted within 5 seconds; the machine will begin to work, the running time is the present time; the display screen will show the remaining time. When the inserted bill quantity is more than the setting quantity, every inserted bills will make the time increase accordingly (the added value: starting time / starting bill quantity). For example: the starting bill quantity is 3, the starting time is 2 (2 minutes i.e. 120 sec.), then it means 3 bills can start it, every bill added will make the time increase:  $120 \text{ sec.} / 3 = 40 \text{ seconds}$ .

#### Shutting off the machine

When the remaining time on the display screen is 0, all the massage function will be shut off, and shows “rEst”, This shows the massage chairs is in the state of reposition. When the massage mechanism finished its reposition, the massage chair will return to standby state. The display screen shows “0” .

#### Take out the cash

- 1.Unlock
- 2.Unfold cover to take out bill box

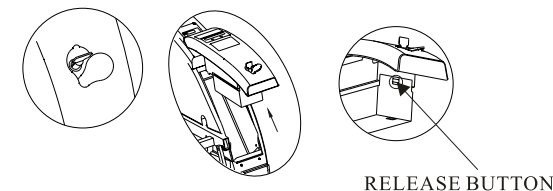

#### Total amount quick inspection

Put the magnetic pen on top of the total amount quick inspection point, the screen then displays the accumulative amount, remove the magnetic pen away, the screen will return to normal state after 3 seconds.

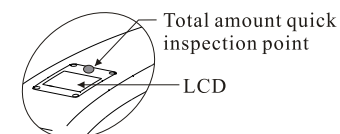

## ▶ NAME AND FUNCTION OF EACH PART

### LCD

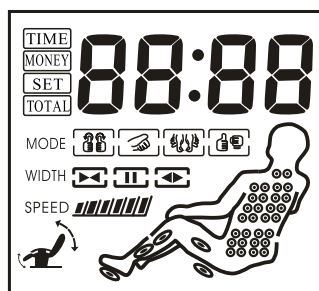

88:88 88:88

Display area for the setting data, running time, remaining time

After the machine is initialized it shows “rEst”. After it recovered to the standby state it shows “0”. When the inserted bill's value didn't reach the setting it shows “---X” (X:0-9). When the inserted bill's value reach the set it shows time “XX : Xx” (X:0-9). When error occurs, it shows the malfunction code (ErrX) (X:0-3)

Under standby state, you can check or change the settings. (Refer to “remote controller” chapter for details) When change the settings, “\_\_XX” will flash, you can press “▲” “▼” to change the data.

TIME  
MONEY  
SET  
TOTAL

Display area for check/change settings

When running, “TIME” appear.  
When check or change total time, “TOTAL” and “TIME” appear.  
When check or change total bill quantity, “TOTAL” and “MONEY” appear.  
When setting starting bill quantity, “SET” and “MONEY” appear.  
When setting starting time, “SET” and “TIME” appear.  
When setting massage chair descending time, “SET” and “TIME” appear.

MODE Message mode display area

Kneading Knocking Finger-pressing Kneading & Knocking

WIDTH Width indicate for knocking and finger-pressing massage modes.

Narrow Middle Wide

SPEED Speed indicate for kneading, knocking and kneading & knocking massage modes.

Slow Middle Fast

Indicator for the parts of air bags.

Calf ascending & descending indicator



Backrest ascending & descending indicator

## ▶ NAME AND FUNCTION OF EACH PART

### Bill acceptor

After the bill acceptor initialized, the green light on the bill acceptor will flash, then it can accept bills.

### Remote controller

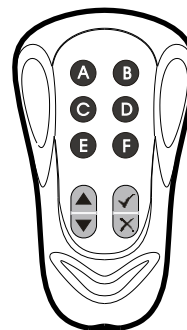

A B C D E F For password setting

▲ Previous menu / increase

▼ Next menu / decrease

✓ Confirm / enter sub-menu

✗ Cancel / back to previous menu

### Password Validated

Under standby mode, connecting remote controller to the machine to start setting, screen shows “\_\_\_\_\_”, please input user's password which consisted by four digital, then press “✓” to confirm password (includes supervisor's password and user's password, original supervisor's password is ABCD, original user's password is AAAA), After successfully proofread password, the machine will select users automatically; while if the system will fail to proofread the password for three times, the machine will be locked and all buttons will be invalid for selection. But you may shut off power and restart the machine. Once the plug of the remote controller pulled out, the massage chair will be the condition out of setting.

## ▶ NAME AND FUNCTION OF EACH PART

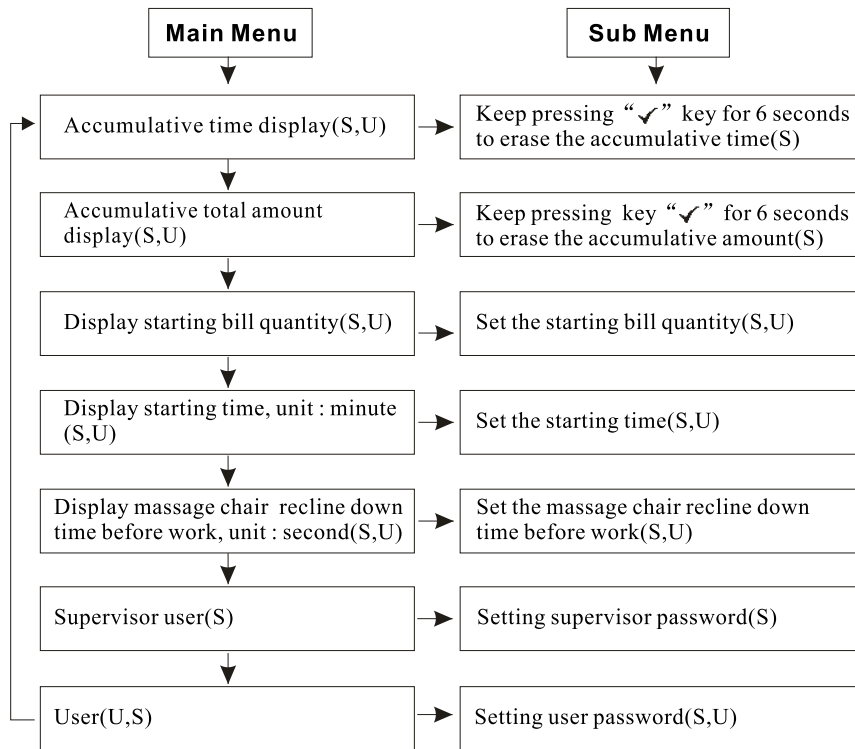

S:supervisor U:user

### Accumulative time:

If the accumulative time is less than 100 hours, the display format is :  
 HH : MM(HH is hour, MM is minute). If the accumulative time is more than or equal to 100 hours and less than 10000 hours, the display is 3 to 4 digits integer of hours (minutes are omitted).

### Accumulative amount:

If the amount is less than 10000pcs of bill's value, the display is 1 to 4 digits integer.

## ▶ NAME AND FUNCTION OF EACH PART

### Starting bill' s quantity:

setting range is 1-99; which corresponds to 1-99 bills.

### Starting time:

setting range is 1-99; corresponding time is 1-99minutes.

### Message chair:

recline down time before work : setting range is 0-15; corresponding recline down time is 0-15 seconds.

### Password setting :

when screen shows "SUP\_" (supervisor) or "USE\_" (user), press " ✓ " button to enter password setting, screen shows " \_ \_ \_ \_ " to remind consumer inputting password which consists of 4 numbers, press " ✓ " to save it, screen shows " \_ \_ \_ \_ " again to remind consumer inputting password again, press " ✓ " to confirm. System will be back to standby mode only when passwords are the same for two times inputting.

### Accumulative time erasure:

Under the display of accumulative time state, keep pressing " ✓ " for 3 seconds, the display screen will show "CLEA" , the time will be erased after 3 seconds. When the action is successful, the screen will show "0" .

### Accumulative amount erasure:

Under the display of showing the accumulative amount state, keep pressing " ✓ " for 3 seconds, the display screen will show "CLEA" , the amount will be erased after 3 seconds. When the action is successful, the screen will show "0" .

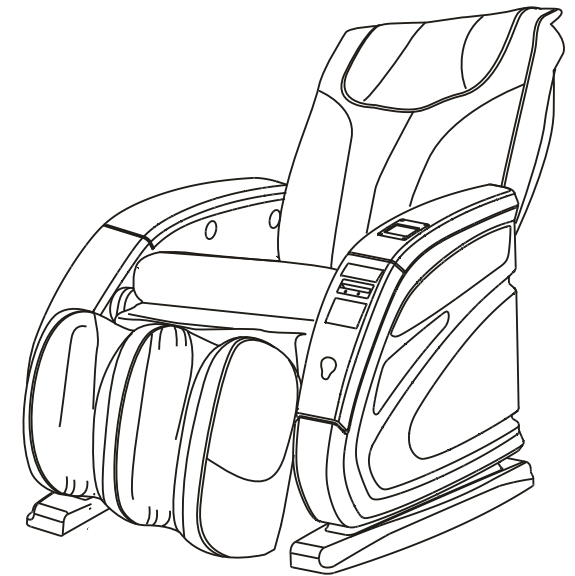

Bill-operated Massage Chair

RT-M12A  
USER MANUAL