

Osaki

Instruction Manual

Model No. OS-Pro Omni



Before operating this unit, please read these instructions completely.

Contents

Before Use

Safety Precautions	1-3
• FCC Radiation Exposure Statement	3
Chair Components	4-6
• Bluetooth Speaker	5
Setting up the massage chair	7-8
Assembly	9-12
Preparation before Use	13-14

How to Use

Controller	15
How to Use	16-19

Q&A / Important

Cleaning and maintenance	20
Troubleshooting	21
Grounding Instructions	22
Chair Specifications	23

Thank you for purchasing this Massage Chair.
Before using your massage chair, please read the contents of this instruction manual and refer to it when needed.

Safety Precautions

When using the massage chair, basic precautions should always be followed to reduce the risk of electric shock, burns, fire or injury to persons. Please read the following precautions before using the massage chair.

- Make sure the power plug is securely inserted into a proper electrical outlet to reduce the risk of short-circuit and fire.
- It is highly recommended that a surge protector is used to prevent from damage.
- DO NOT use the massage chair in areas where the humidity is high such as sauna steam rooms, pools, bathrooms, AC or heating vents, etc.
- DO NOT use the massage chair outdoors and avoid areas with direct sunlight.
- If the chair is not being used, turn the power switch to the OFF position and unplug the massage chair from the electrical outlet to prevent any damages to the chair when there are power outages/surges that may cause serious damage.
- Never plug/unplug the power cord plug socket with wet hands.
- Close and continuous supervision is necessary when the massage chair is used by, on or near children or disabled persons.
- No more than one person should use the massage chair at the same time.
- The massage chair is intended for use as described in the Instruction Manual. Do not use any attachments other than those recommended by the manufacturer.
- DO NOT attempt to stand or sit on the backrest, armrest or footrest in order to prevent accident, injury or damage to the chair.
- Avoid falling asleep while using the massage chair.
- Always keep the massage chair clean, and never insert any objects into or around the gaps of the massage chair.
- DO NOT move the massage chair by pulling on the power supply cord.
- Make sure there are no children, pets or other obstacles behind or underneath the massage chair.
- If you find any rips or tears in the fabric of the massage chair, contact the service department and stop using the chair immediately.
- This massage chair is designed for household use and should not be used in non-residential settings.

Safety Precautions

- Please consult your doctor if you are in doubt as to whether or not you should use this massage chair.
- Please consult a doctor before using the massage chair if you are pregnant, undergoing any medical treatment, using a medical electronic device such as a pacemaker, or are experiencing any of the following: malignant tumor, heart disease, back pain, abnormal or curved back bone, osteoporosis or acute illness.
- If you experience pain while using the massage chair, stop using the chair immediately and consult your doctor.
- Never use a massage function on swollen or inflamed parts of the body.
- DO NOT use the massage chair for more than 30 minutes at a time.
- DO NOT use the massage chair where aerosol(spray) products are being used or where oxygen is being administered.
- This massage chair is a non-professional product designed to provide a comfortable massage and should not be substituted for appropriate medical treatment.
- Never operate the appliance with the air hoses that inflate while they are blocked. Keep the air openings free of lint, hair, and any other obstructions.
- Check the skin which is in contact with the heated area of the appliance frequently to reduce the risk of injury. If the heating pad malfunctions and extreme heat is produced it may cause serious burns.
- Burns may result from improper use. If this is the case immediately shut off the chair and unplug from the outlet.
- Remove all sharp objects from the body and pockets such as keys and pens.
- Keep children away from extended foot support (or other similar parts.)
- DO NOT WET-DO NOT USE PINS.
- NEVER REMOVE COVER.



Caution

The user's weight is usually limited to 220 lbs.

For those who are weighing 220 lbs or more, the product operations may make more noise and the fabric cover may wear out faster.

FCC Radiation Exposure Statement

FCC Radiation Exposure Statement: (mobile device)

This equipment complies with FCC radiation exposure limits set forth for an uncontrolled environment. In order to avoid the possibility of exceeding the FCC radio frequency exposure limits, Human proximity to the antenna shall not be less than 20cm (8 inches) during normal operation.

FCC STATEMENT

1. This device complies with Part 15 of the FCC Rules. Operation is subject to the following two conditions:

- (1) This device may not cause harmful interference, and
- (2) This device must accept any interference received, including interference that may cause undesired operation.

2. Changes or modifications not expressly approved by the party responsible for compliance could void the user's authority to operate the equipment.

This equipment has been tested and found to comply with the limits for a Class B digital device, pursuant to part 15 of the FCC Rules. These limits are designed to provide reasonable protection against harmful interference in a residential installation. This equipment generates, uses and can radiate radio frequency energy and, if not installed and used in accordance with the instructions, may cause harmful interference to radio communications. However, there is no guarantee that interference will not occur in a particular installation. If this equipment does cause harmful interference to radio or television reception, which can be determined by turning the equipment off and on, the user is encouraged to try to correct the interference by one or more of the following measures:

- Reorient or relocate the receiving antenna.
- Increase the separation between the equipment and receiver.
- Connect the equipment into an outlet on a circuit different from that to which the receiver is connected.

Chair Components

Front

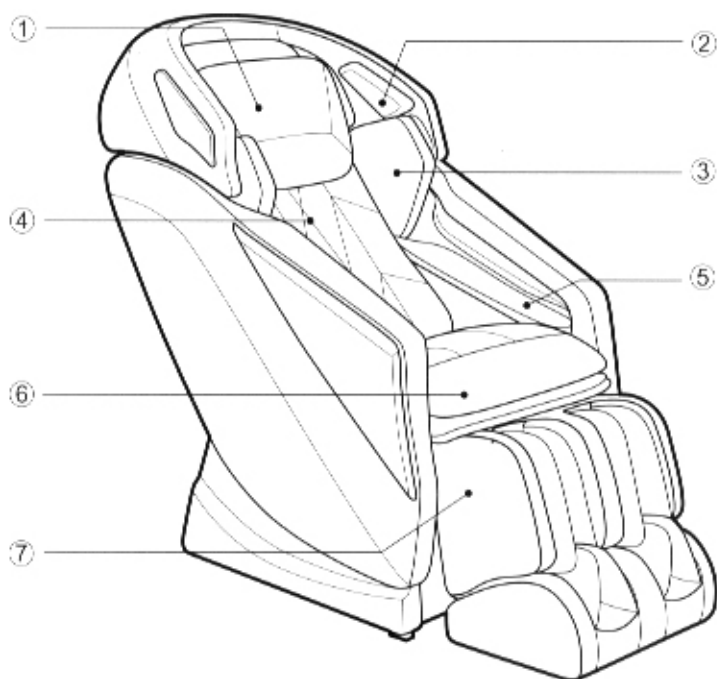

① Pillow Pad

③ Shoulder side massage section

⑤ Hand and arm massage section

⑦ Legrest

② Bluetooth Speaker (See Page 5)

④ Backrest Pad

⑥ Seat

Chair Components

Bluetooth Speaker

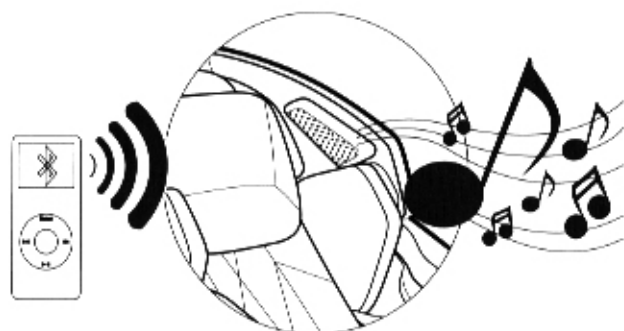



NOTE:

The bluetooth speaker can only connects with one bluetooth device at a time. Please turn off your bluetooth device after using so that other users can enjoy it as well.

Chair Components

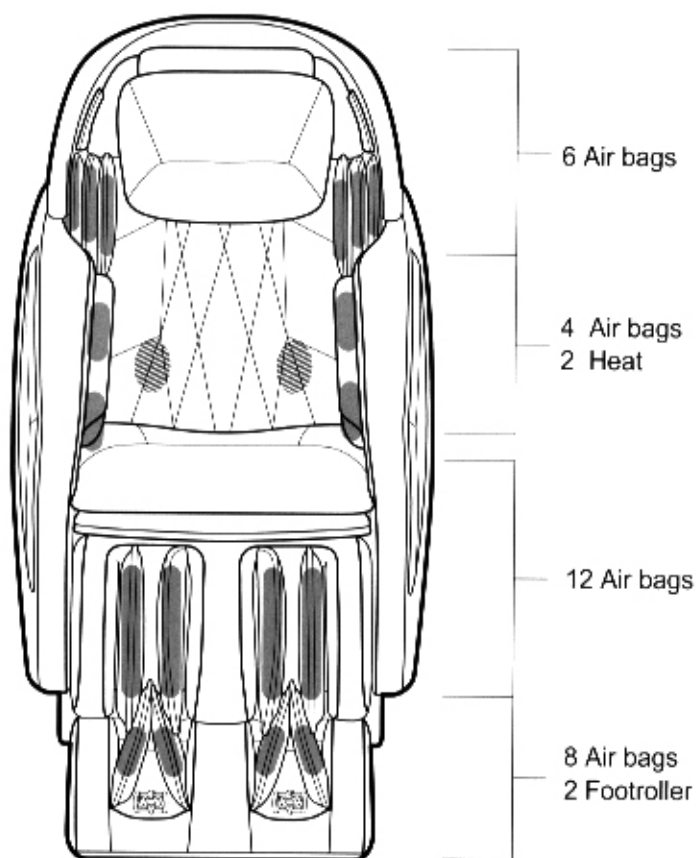
Air Massage Area



 Air bag

 Heat

 Foot Roller

Setting up the massage chair

1. Installation Position.

- Ensure there is adequate space to recline.

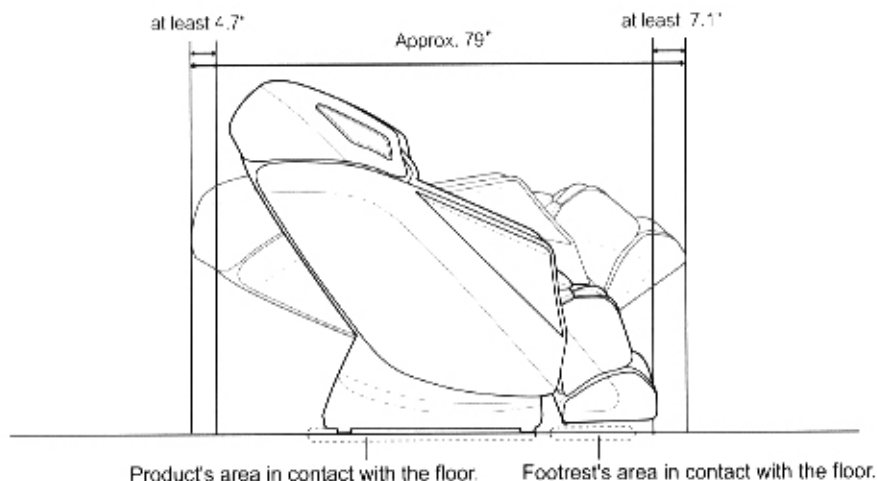

- Do not expose the massage lounger to direct sunlight or high temperatures, such as in front of heating sources, because this can cause discoloration or hardening of the synthetic leather.
- Place the unit on a mat to prevent floor damage.
- When placing a mat under the unit, the size of the mat should be sufficient (at least 52" x 32") to cover the areas where the unit touches and where the legrest could touch the floor, as shown in the diagram on the above.
- Install the unit near a power outlet.

Setting up the massage chair

2. Remove all the contents from the 3 boxes. Collect all the units and the accessories.

Main unit

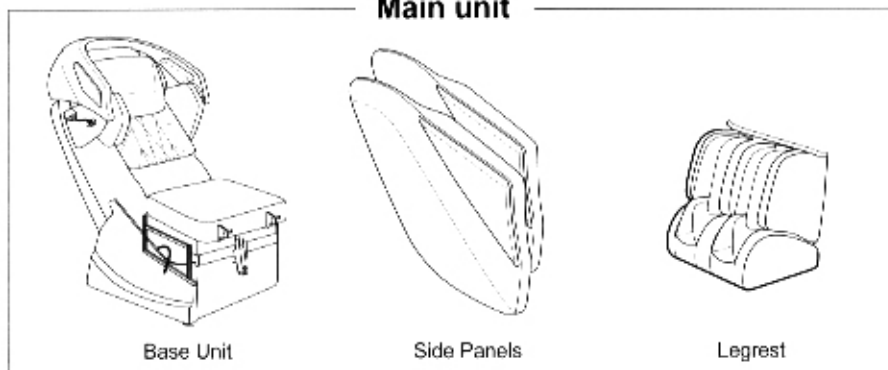

Accessories

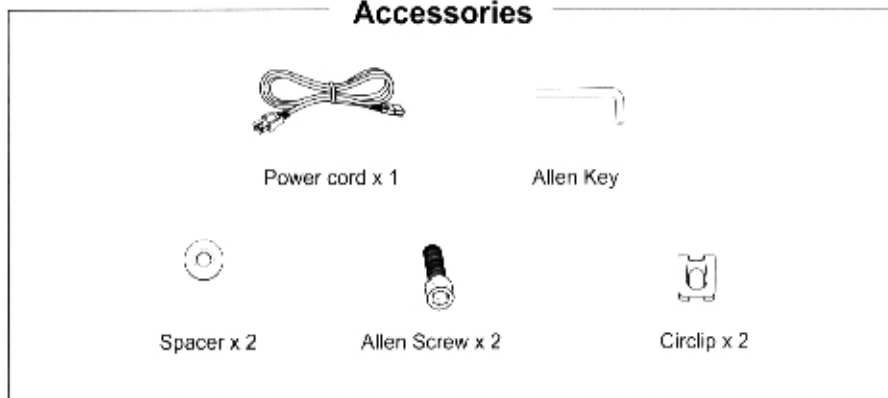

Assembly

1. Attach the side panels.

- ① Take out the right side panel and move it close to the chair.
- ② Align and connect the air hoses C1 and C2
- ③ Align the groove A1 and the protrusion A2. Insert A2 into A1. Insert B1 to B2.
- ④ Align the D1 and D2. Fasten them with the Allen screw and Allen key provided.

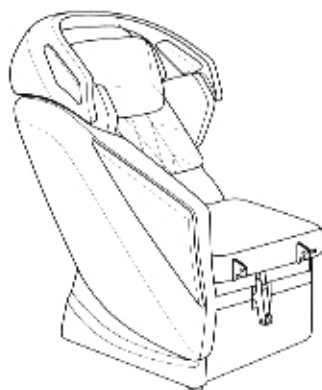
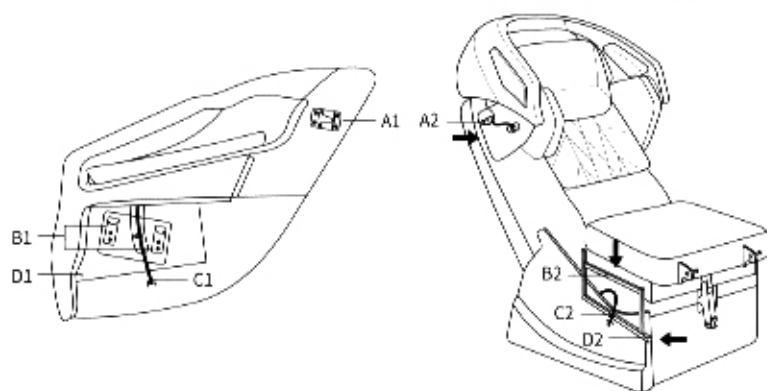
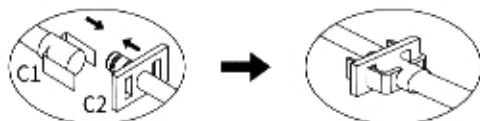

Assembly

- ⑤ Repeat the steps above to install the left side panel.



3. Attach the legrest.

- ① Connect all the air hoses and wires (E1 to E2, F1 to F2, G1 to G2)
- ② Align the holes H1 and shaft H2, let H2 pass through H1
- ③ Lock the shafts with the circlips provided.

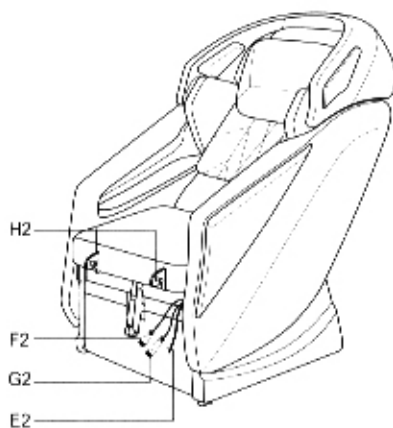
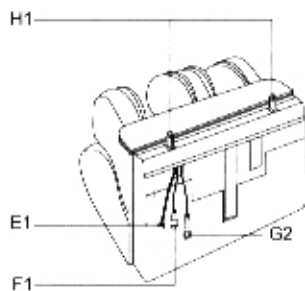

Assembly

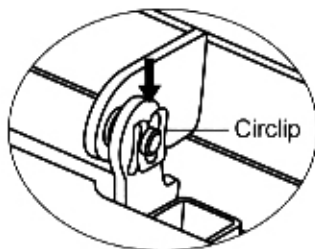
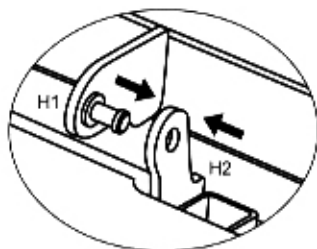
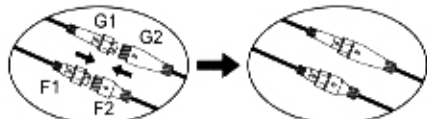
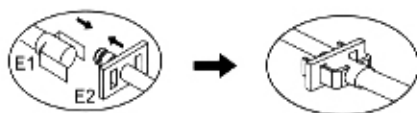

4. Attach the backrest pad.

- ① Attach the velcros on the seat side.
- ② Connect the wire J1 to J2.
- ③ Zip the zipper on the top of backrest.
- ④ Attach the velcros under the backrest and seat cushion.
- ⑤ Zip the zipper connecting legrest and seat cushion.

Assembly

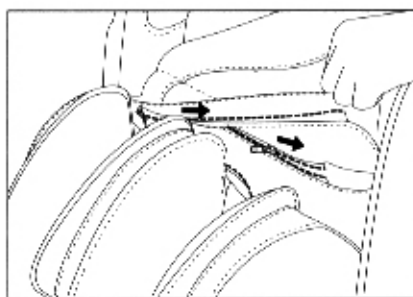
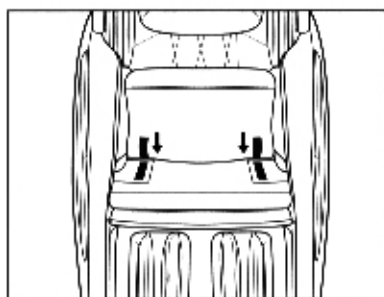
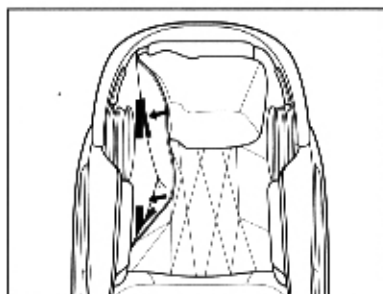
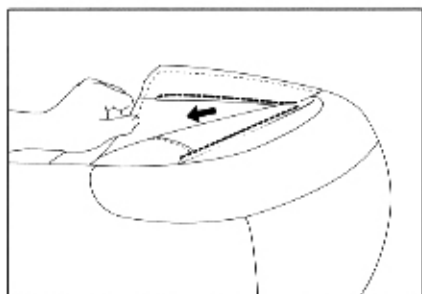
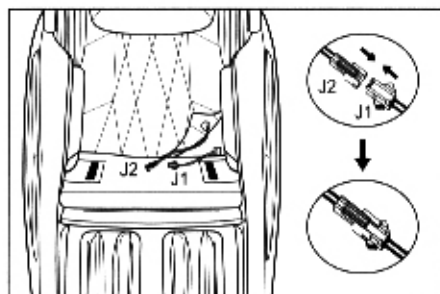
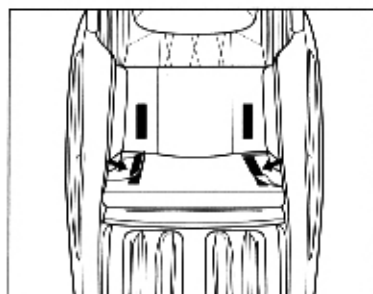

Installation completed.

Preparation before Use

1. Check the space around the product.

Make sure there is no person, pet, or other object close to the product.

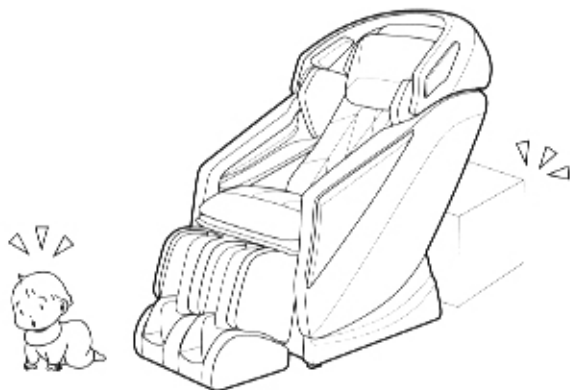

2. Make sure there is no foreign matter in the seams of the product.

- Before sitting on the product, make sure there is no foreign matter between any two parts of it.
- Do not put hands, arms or head between the backrest and the back cover.
- Do not put pets on the product (such as its back cover, backrest and armrests).

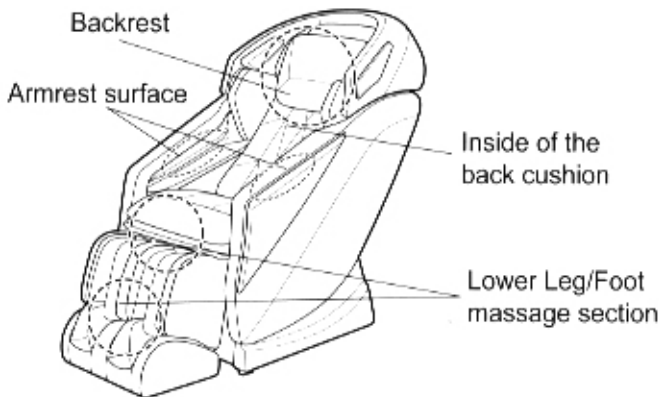

Preparation before Use

3. Power on the product

- ① Push the power connector into the appliance inlet till the end.
- ② Insert the power plug into the power outlet till the end.
- ③ Turn the switch to "I" position

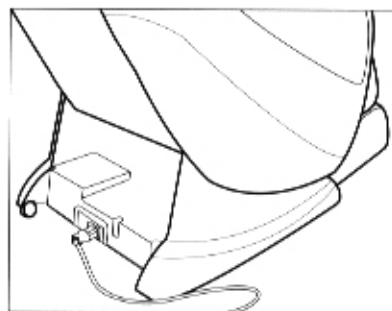
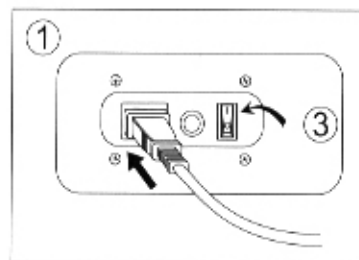

4. Make sure the massage rollers are retracted.

If they are not, press ON button to return them to the retracting position.

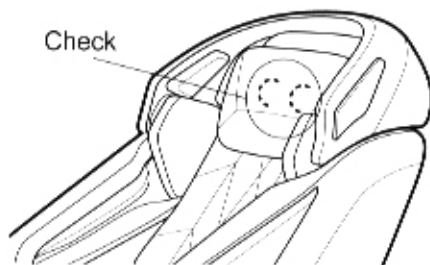

How to Use

Controller

- 1. Power (P16)
- 2. Timer (P16)
- 3. Pause (P16)
- 4. Deep Tissue (P16)
- 5. Stretch (P16)
- 6. Calm (P16)
- 7. Relax (P17)
- 8. Wake Up (P17)
- 9. Sleeping (P17)
- 10-11. Width (P17)
- 12-13. Position (P17)
- 14. Spot/Partial (P17)
- 15. Zero Gravity (P18)
- 16. Manual (P18)
- 17. Direction (P18)
- 18. Intensity (P18)
- 19. Speed (P18)
- 20. Strength (P18)
- 21. Full Air (P18)
- 22. Partial Air (P19)
- 23. Heat (P19)
- 24. Foot Roller (P19)
- 25. Recline/Footrest lift (P19)
- 26. Incline/Footrest drop (P19)

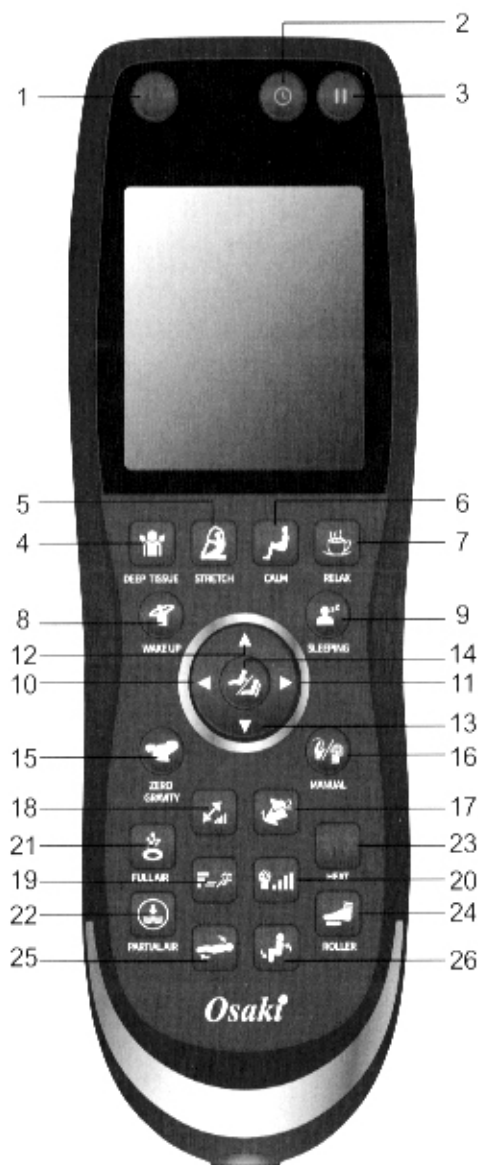

How to Use

Programs Description

1.Power

- Starts and stops all functions of the massage chair.
- Press once. Remote control will light up and chair will be in idle mode.
- You can press any massage function buttons to begin your massage session, at a default time of 15 minutes.
- Press again, all functions will stop and massage rollers will return to original position.

2.Timer

- Controls the duration of the massage session.
- The default time for all massage functions is 15 minutes.
- Press each time to change the duration for 20, 25, 30, 05, 10 or 15 minutes.

3.Pause

- All massage functions will stop temporarily.
- Press once and the Pause icon will light up.
- Massage functions and timer will be stopped temporarily.
- Press again to resume the massage session.

Auto Programs

- This function is a full body massage with 6 different massage styles.
- Position of the chair can be manually adjusted.
- Massage session is 15 minutes by default.

4.Deep Tissue

- Engages the full body deep tissue massage. This program focuses on neck, shoulder, waist and hip.

5.Stretch

- Engages the full body stretching auto program. This program stretches the back muscles, hands, hamstrings and the full body.

6.Calm

- Engages the full body gentle massage.

How to Use

7. Relax

- Engages the full body relax auto program.
- This program will start with a slow kneading and heavy tapping massage, progressing to in-depth massage targeting the neck and lower back.

8. Wake Up

- Engages the full body wake up auto program.
- This program will deliver a light, stimulating tapping massage throughout the whole body.

9. Sleeping

- Gentle relaxation course based on tapping actions helps you to fall asleep with cradle alike function.

10/11. ◀/▶ Width

- Controls the width of the rollers.
- Select a massage function and press to adjust between Narrow, Normal and Wide.
- It can be used to activate the Tapping, Shiatsu and Rolling massage.

12/13. ▲/▼ Position

- Adjust back massage position.
- Press ▲ or ▼ to choose position of massage rollers when a "beep" sound alerts in 10 seconds.
- Release the button once the desired position is achieved.

Note: This can also be used during sector massages.

14. Spot/Partial

- Press once to localize the massage to a particular point.
- Press again to shift massage to a particular area of body.
- This will keep the original massage mode working on a range of 8cm.
- To resume full back massage, press button again.

How to Use

15. Zero Gravity

- Adjust the angle of the massage chair to zero gravity position.
- Press to achieve position required.
- Press again to resume to original position.

16. Manual

- Press this button to activate manual massage function including Kneading, Swedish, Tapping, Shiatsu, Clapping and Rolling.

17. Direction

- Press this button to switch the mode of manual massage function.

18. Intensity

- Press this button to adjust the air pressure intensity level.
- After activating the auto or manual air massage programs, press to select between 5 levels of intensity.

19. Speed

- Press this button to adjust speed for Swedish, Tapping, Shiatsu and Clapping.
- 5 stage speed available for adjustment.

20. Strength

- Press this button to adjust strength for Kneading.
- 5 stage strength available for adjustment.

21. Full Air

- Engages the the full body air pressure auto program.
- This program applies full body air pressure massage to shoulder, arm, palm, lower back, buttocks, thighs, calves and feet.
- Full Air intensity can be adjusted by pressing "Intensity" button respectively after activating full air function.

How to Use

22. Partial Air

- Press this button to activate and select air massage zone between armrest, shoulder & waist, calves and feet.
- Air intensity can be adjusted by pressing "Intensity" button respectively after activating manual air function.
- Full Air intensity can be adjusted by pressing "Intensity" button respectively after activating full air function.

23. Heat

- Heat function is set to OFF by default.
- Press this button once to activate the waist heating function. Press the button again to stop the waist heating function.
- It is applicable during any Automatic Program, Localised Area Program or Manual Program.

24. Foot Roller

- Press once, to activate the foot roller massage.
- Press again, to stop the foot roller massage.

25. Recline/Footrest lift

- Press this button to recline the chair.
- Press again to stop at the angle you desire.
- Long press this button to lift the footrest. Loose to stop at the position you desire.

26. Incline/Footrest drop

- Press this button to incline the chair.
- Press again to stop at the angle you desire.
- Long press this button to drop the footrest. Loose to stop at the position you desire.

Cleaning and maintenance

1. Cleaning of the synthetic leather

Wipe the synthetic leather with a soft dry cloth.

- Do not clean the product with chemicals such as thinners, gasoline and alcohol.
- When using a leather maintenance product (cleaning cloth) sold on the market, follow its directions for use.
- If the synthetic leather is very dirty, wipe it with the method below.

- 1) Put a piece of soft cloth into water or 3% to 5% neutral detergent contained hot water and wring it out.
- 2) Wipe surface of the synthetic leather with the soft cloth.
- 3) Wipe the detergent with a piece of cloth once soaked in clean water and wrung out.
- 4) Wipe with a piece of wrung soft cloth.
- 5) Have the synthetic leather take natural air drying.

- If it is difficult to remove the stains on the synthetic leather, soak a piece of melamine foam bought from the market into a neutral detergent and use it wipe the product.
- Do not dry the surface by a hair drier.
- Surface of the synthetic leather may be dyed by fabric colors; therefore, be careful when wiping the product with denim or colored cloth.
- Synthetic leather may discolor, so the position in contact with the hair dye used should be covered by a towel.



2. Cleaning of the plastic parts

- 1) Put a piece of soft cloth into water or neutral detergent contained hot water, wring it out and wipe the plastic parts.
- 2) Wipe with a piece of cloth once soaked in clean water and wrung out.
- 3) Have the plastic parts take natural air drying.

- Do not clean the product with chemicals such as thinners, gasoline and alcohol.



Troubleshooting

This page summarizes the most common problems you could encounter with the product. If you are unable to solve the problem with the information below, contact service center immediately.

If the problem encountered is not listed, please try the following suggestions:

1. Turn off the product and unplug it.
2. Wait for 60 minutes.
3. Plug the product back to the recommended outlet and restart.
4. If the problem persists, contact the authorized service center.

Problem	Possible Cause	Suggestion
The product does not work	The product is not plugged in properly.	Ensure the voltage on the product corresponds to the local mains voltage and then plug in again. Make sure the outlet is properly working.
The product stopped working	The product has just finished its auto timer session and has automatically switched to standby mode.	If you want another session, press the Power button again.
The product stopped working	You may have used the product continuously for 45 minutes where the over heat protection has been activated.	Unplug the product and let it cool down for 60 minutes before you use it again.
The product does not work	An excessive load has been applied on the product.	Reduce the excessive load and start again.
The product is abnormally warm	The product is likely to be overused.	Unplug the product and let it cool down before using it again.
Noise can be heard from the product	Noise is made by the mechanical parts of the product.	This is normal and does not mean that the product is faulty.

Grounding Instructions

This product must be grounded. If it should malfunction or break down, grounding provides a path of least resistance for the electric current to reduce the risk of electric shock. This product is equipped with a cord with an equipment-grounding conductor and a grounding plug. The plug must be plugged into an appropriate outlet that is properly installed and grounded in accordance with all local codes and ordinances.

Danger-Improper connection of the equipment-grounding conductor can result in a risk of electric shock. Check with a qualified electrician or service technician if the product will not fit the outlet, have a proper outlet installed by a qualified electrician.

This product is for use on a nominal 120V circuit and has grounding plug that looks like that plug illustrated below. Make sure that the product is connected to an outlet having the same configuration as the plug. No adapter should be used with this product.

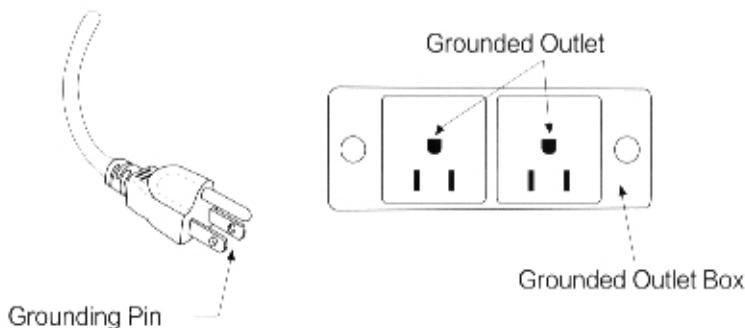

Chair Specifications

Description	Specifications
Model No.	OS-Pro Omni
Rated Voltage	110V~120V
Rated Frequency	50/60Hz
Rated Power Consumption	220W
Timer	5/10/15/20/25/30 minutes
Max Time Rate	30 minutes
Dimensions(L x W x H)	Upright: 62.6"x33.1"x49.2"
	Reclined: 74.8"x33.1"x36.2"
Weight	Gross Weight: Approx. 264.6 lbs
	Net Weight: Approx. 216.1 lbs
Length of Wire	Controller wire: 59.0"
	Power supply wire: 70.9"
Usage Condition	Environment temperature: 32°F~95°F
	Contrasting humidity: 20-80RH
Storage Condition	Storage temperature: 23°F~95°F
	Storage humidity: 20-80RH
Safety Feature	Equipped with overheated and power
Maximum body weight of user	220 lbs