

Osaki

OS-HIGHPOINTE 4D

User 's Manual

Osaki

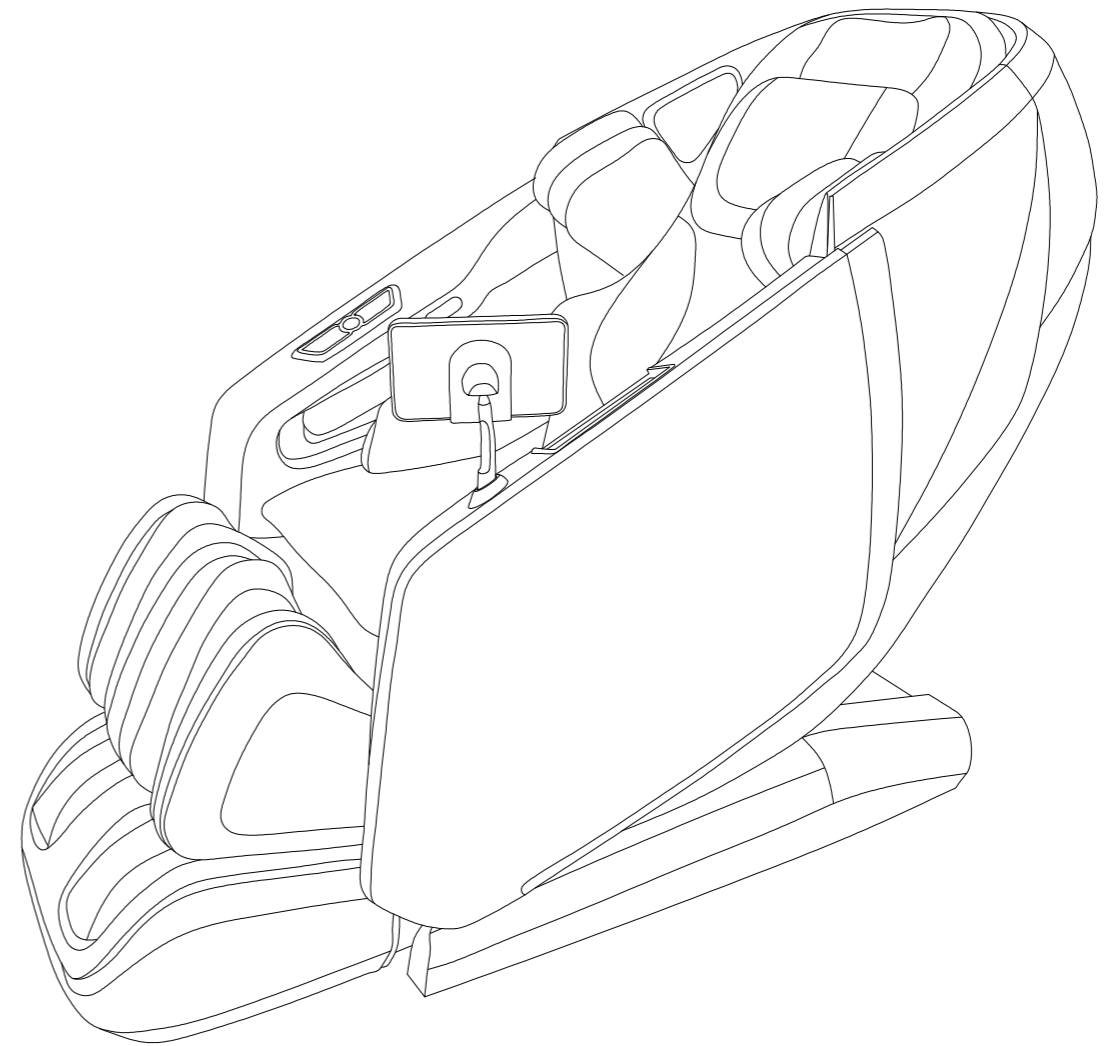

Please read SAFETY INSTRUCTIONS carefully before using the chair.

- ★ 1. Thank you for purchasing the OS-Highpointe 4D massage chair
 - 2. Please read the user manual carefully to understand the operation way before operating the chair.
 - 3. Keep the user manual in good condition for review if needed.
 - 4. Please pay special attention to the “safety precautions” section.
- ★ Note: We reserve the right to change the design and explanation of the products, subject to change without prior notice. The pictures in the manual are for reference only.



Contents

Preparation	Safety precautions -----	1
	External structure name -----	5
	Internal structure name -----	6
	Mechanical components diagram -----	7
	Mechanical components list -----	8
Installation	Installation -----	9
Massage Operation	The adjustment before massage -----	15
	Built-in remote instructions -----	17
	Tablet remote control operation -----	19
	Voice control use method -----	27
	Operational Instruction and Function Illustration -----	29
After Massage -----	32	
Maintenance	Clean and maintenance -----	33
Others	Malfunction guide -----	34
	Technical data -----	35





Please store the user manual in a good place for reading at any time

- ★ Please read this manual carefully before use, and install and use it correctly according to the requirements of the manual.
- ★ The safety precautions are to explain the size and severity of the hazard and damage. And divide some situations that may occur due to incorrect use and assumptions into two aspects: [Warning] and [Caution].



Both are important safety warnings, please pay attention to them.

 Warning	This symbol is a warning that death or injury may occur.
 Caution	This symbol is a warning of possible injury or damage.







The Meaning of Symbols

	This symbol indicates prohibited behavior.		This symbol means that it is forbidden to disassemble by yourself.
	This symbol means that you must follow the instructions.		This symbol indicates the correct operation of the power cord.





- ★ After reading the following content, please be sure to keep it at any time.

 Warning	
 <ul style="list-style-type: none"> ● Patients with osteoporosis, spine fractures, and those suffering from acute painful diseases such as sprains or muscle strains. ● Heart disease patients (including those who are equipped with a pacemaker or are using other medical electronic equipment) Malignant tumor patients. ● People who suffer from perceptual impairment due to diabetes and other high-level peripheral circulatory disorders. ● People with abnormal spine or curved spine. ● People with herniated disc. ● Pregnant women and those who have just finished childbirth, and those who are in poor health. ● People suffering from trauma such as thrombosis, acute venous tumor, various skin inflammations, etc. ● People who have been found to have lost the ability to discern temperature. ● People with high fever symptoms (acute inflammation: such as fatigue, chills, changes in blood pressure, physical weakness) ● Seniors over 80 ● People who are mentally handicapped, or incapable of operating this machine are prohibited from using this machine. ● People who cannot take care of themselves, infants and drunk persons are prohibited from using this machine. ● It is forbidden to use this machine if it gets wet or people with wet body. ● People who are not sensitive to heat or those who are allergic to heat must be careful when using it, or do not use it. ● Do not fall asleep in this chair. <p>People with the above symptoms should not use a massage chair. The user's discretion is advised. Please consult your doctor or physician prior to use if you have additional questions.</p>	<p>For users not suitable, it may cause accidents or physical discomfort.</p>



Preparation

 Warning	
 <ul style="list-style-type: none"> ● Before sitting, please make sure that there are no foreign objects between the various parts of the machine. ● When using the backrest lift, lower leg lift, and lower leg extension, make sure that there are no people or objects around (behind, under, or in front of the chair). ● If you experience abnormalities or feel abnormalities during use, stop using it immediately and ask your doctor. ● When massaging around the head, pay attention to the movement of the massage head, and don't massage the head too much. ● When massaging the surrounding areas of the neck, be especially careful and avoid massaging the neck too heavily. ● Do not use this machine to massage your abdomen or knees. ● If you want to leave the seat during the massage, you must stop the operation of the massage chair before leaving the seat. ● Do not use it with other equipment at the same time. ● Do not let children or pets play on or around the machine (especially when in use); also do not sit or stand on the backrest, armrests, or legs. ● When used by people with limited mobility or lack of communication skills, strict and continuous care must be provided. ● Before moving the machine, the angle of the backrest and legs must be adjusted back to the original state. 	<p>Accident or injury</p>
 <ul style="list-style-type: none"> ● When installing this machine, please turn off the power switch and unplug the power plug after the chair is reset. ● Only connect the plug of this machine to a suitable power outlet. And be sure to fully insert the plug into the power socket to reduce the risk of short circuit or fire. ● When not in use, be sure to unplug the power plug of the machine. Before unplugging the power plug, turn off all massage actions and switches. 	<p>Fire and electric shock</p>
 <ul style="list-style-type: none"> ● It is forbidden to curl and store the cushions and other accessories of the massage chair. ● It is forbidden to run the machine without load for a long time. ● It is forbidden to leave the appliance unattended after plugging in the power source. 	<p>Accident</p>
 <ul style="list-style-type: none"> ● Do not use it when the power plug or socket is loosely inserted. To prevent electric shock and short circuit. ● Do not use a power supply other than the rated voltage to avoid fire, electric shock or malfunction. ● The power cord must not be broken, reworked, twisted, stretched, knotted, or pressed with heavy objects (pay special attention not to be pressed under the machine), etc. ● If the power cord or plug is damaged, cannot work normally, please do not use this product. ● Keep the power cord away from heat sources. 	<p>Fire and electric shock</p>
 <ul style="list-style-type: none"> ● If the machine is not working properly, has been dropped or damaged, has been splashed or dropped into the water, it must be repaired by professionals or sent to the designated repair center. Do not modify, disassemble and repair by yourself. ● If the power cord is damaged, you must use a special power cord or buy special components from its manufacturer or maintenance department to replace it. ● To avoid electric shock or personal injury, please do not open or disassemble any parts of this machine without authorization. There are no user-serviceable parts in this machine. ● Before use, please lift the back cushion to check whether the fabric of the backrest and other parts is damaged. If there is any damage (no matter how small the damage), please stop using it in time and unplug the power socket. Request for a repair. 	<p>Disassembly and repair</p>

Preparation

 Caution		
	<ul style="list-style-type: none"> Please use it on a flat ground. 	To prevent it from accidental dumping.
	<ul style="list-style-type: none"> Please start with a light massage. The recommended use time is 20 minutes, and the same position massage within 5 minutes. 	Long time continuous use will have an adverse effect.
	<ul style="list-style-type: none"> Please confirm the correct position of the massage head before sitting down slowly. 	To avoid accidental damage.
	<ul style="list-style-type: none"> The tablet hand controller should be placed on the tablet support in time, and do not randomly place it to avoid damage to the tablet hand controller from being squeezed or dropped. 	
	<ul style="list-style-type: none"> Before connecting the power plug to the socket, be sure to check that the power switch is in the off position. 	Otherwise, it may cause an accident when the power is restored.
	<ul style="list-style-type: none"> When not in use, before unplugging the power plug, turn off all massage actions and switches. 	To reduce the risk of short circuit and fire.
	<ul style="list-style-type: none"> Be sure to insert the power plug completely into the power socket. 	
<ul style="list-style-type: none"> Check whether the power cord is damaged, there should be no adherents such as moisture or trash on the power plug. 	If you don't pay attention, you may get an electric shock in case of leakage or malfunction.	
<ul style="list-style-type: none"> For safety, please install the ground wire accurately. The power plug must be plugged into a socket with a grounding wire. The ground plug cannot be bent or removed. 		
	<ul style="list-style-type: none"> Do not press or step on the massage head with hands and feet. Do not reach between the active massage heads. Do not put your hands and feet into the gaps of the movable mechanism. Please do not let objects fall or jam into any slots of the machine. Do not stand, sit or put anything on the backrest, armrests, or calves. Do not stand, sit or put anything on the backrest, armrests, or calves. Do not stand on the machine during use. Do not unplug the power plug and turn off the power switch during use. Do not put your hands and head into or under the calf massage area. Do not use hard hair accessories on the head. When massaging the buttocks and thighs, there should be no hard objects in the trouser pockets. Do not hit the armrest with hard objects or sharp cones, so as not to affect the appearance of the armrest. When the backrest of the massage chair is in an inclined position, do not sit on it or press it heavily. Do not use it when the skin is bare or wearing only thin clothes. Although thin clothes can enhance the massage effect, it may cause skin irritation and pain or low-temperature burns. Do not use this product immediately after meals, as it may cause physical discomfort. Do not use this machine while wearing loose clothes or jewelry. Keep long hair away from the massager. 	Keep long hair away from the massager.
	<ul style="list-style-type: none"> Keep this machine away from heat, humidity, sharp objects, and corrosive, flammable and explosive environments. It is forbidden to put heating items such as electric blankets on the machine. 	Otherwise, the fabric will fade, change color, or harden and deteriorate the synthetic leather.
	<ul style="list-style-type: none"> Do not approach the stove or place it around heating appliances such as heaters. 	
	<ul style="list-style-type: none"> Do not place it under direct sunlight or in an environment where the room temperature is higher than 40°C. 	
	<ul style="list-style-type: none"> Do not place it in an environment with severe dust or corrosive gas. 	
	<ul style="list-style-type: none"> Do not place it in a small space or use in a place with poor air circulation. 	
	<ul style="list-style-type: none"> Do not use this unit outdoors. 	

Preparation

 Caution		
	<ul style="list-style-type: none"> Please keep it dry and do not use or store this product in swimming pools, bathrooms and other particularly humid environments. The chair and the controller can not be sprinkled with water. Do not use this product when the body is wet. 	To prevent leakage or electric shock.
	<ul style="list-style-type: none"> Be sure to install the ground wire correctly. (Improper grounding connection may cause electric shock hazard. If you have any doubts about the correctness of the grounding of the machine, please entrust a qualified electrician for inspection.) Please do not use plug adapters. (If the plug attached to the machine does not match your socket, please do not modify the plug, but ask an electrician to install a suitable socket.) 	To reduce the risk of electric shock.
	<ul style="list-style-type: none"> Before cleaning the machine, be sure to unplug the power plug. After using this machine, be sure to unplug the power plug. 	To prevent fire or electric shock.
	<ul style="list-style-type: none"> In the event of a power failure, please unplug it immediately. 	
	<ul style="list-style-type: none"> Please pull out the power plug by holding the plug. Avoid pulling the power cord to unplug the power plug. 	To prevent accidents.
	<ul style="list-style-type: none"> After each massage, please turn off the power switch and unplug the power plug. 	Otherwise, it may cause an accident or injury when the power is restored.
<ul style="list-style-type: none"> Unplug the plug immediately when there is a power failure. 		

Preparation

Grounding Instructions

- ✦ ✘ This machine is equipped with a cable with a grounding plug. The plug must be plugged into a well-installed and grounded socket that meets the requirements of this plug.

Replace the Fuse

- ✦ ✘ When the fuse is blown, please unplug the power plug first, turn off the power switch, then use a screwdriver to open the fuse box cover on the switch box, replace with a new fuse of the same specification, and then reinstall the fuse box cover or entrust an electrician to assist in the replacement.

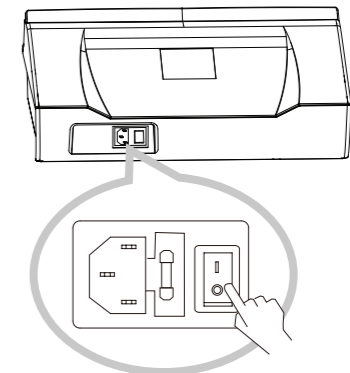

 The place where the ground wire cannot be set.

Gas pipe: may cause explosion and fire.

Telephone lines and lightning rods: lightning may cause electric shock and fire.

Water pipe: The ground wire does not work where there is plastic in the water pipe.

External Structure

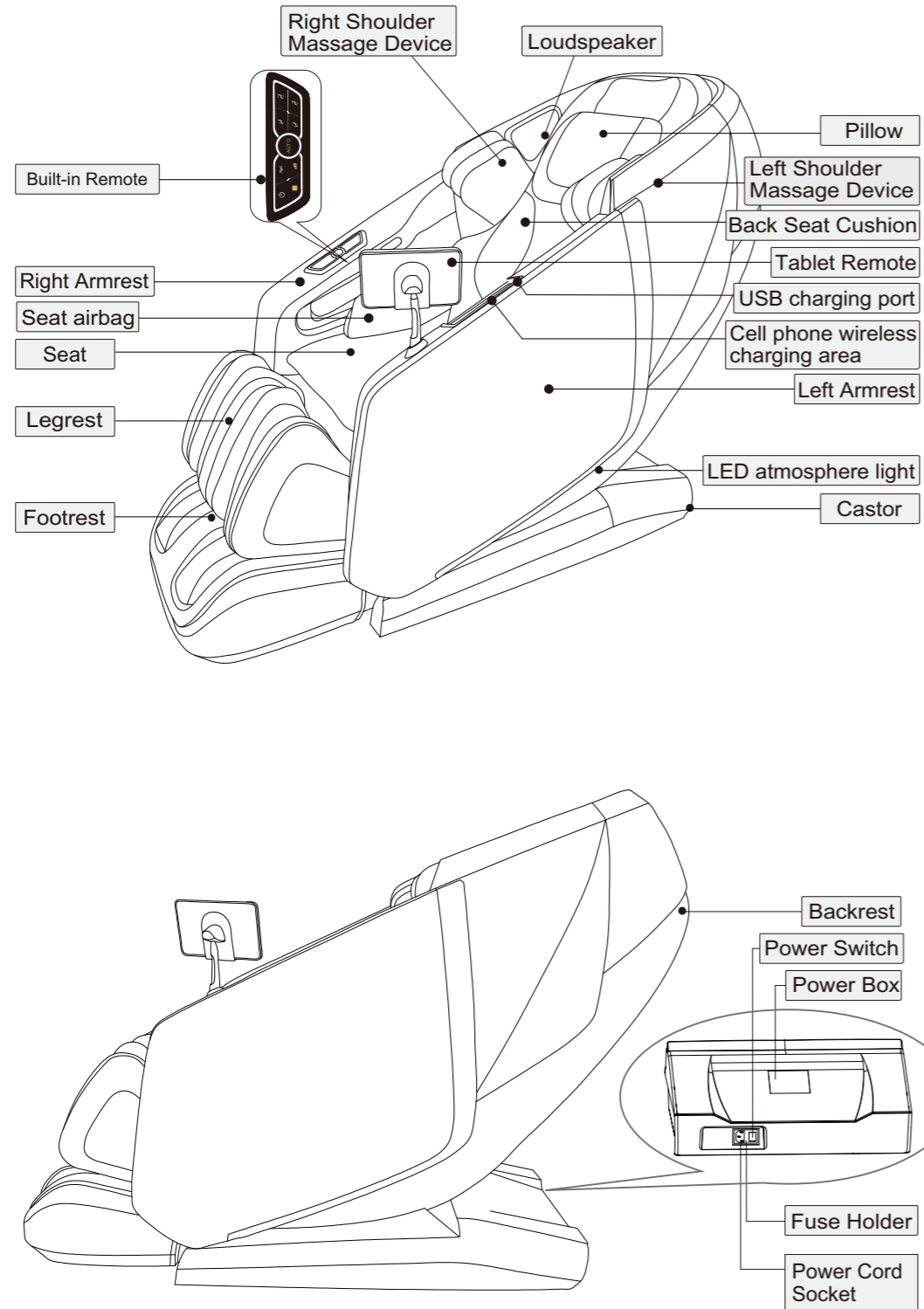

Preparation

Internal Structure

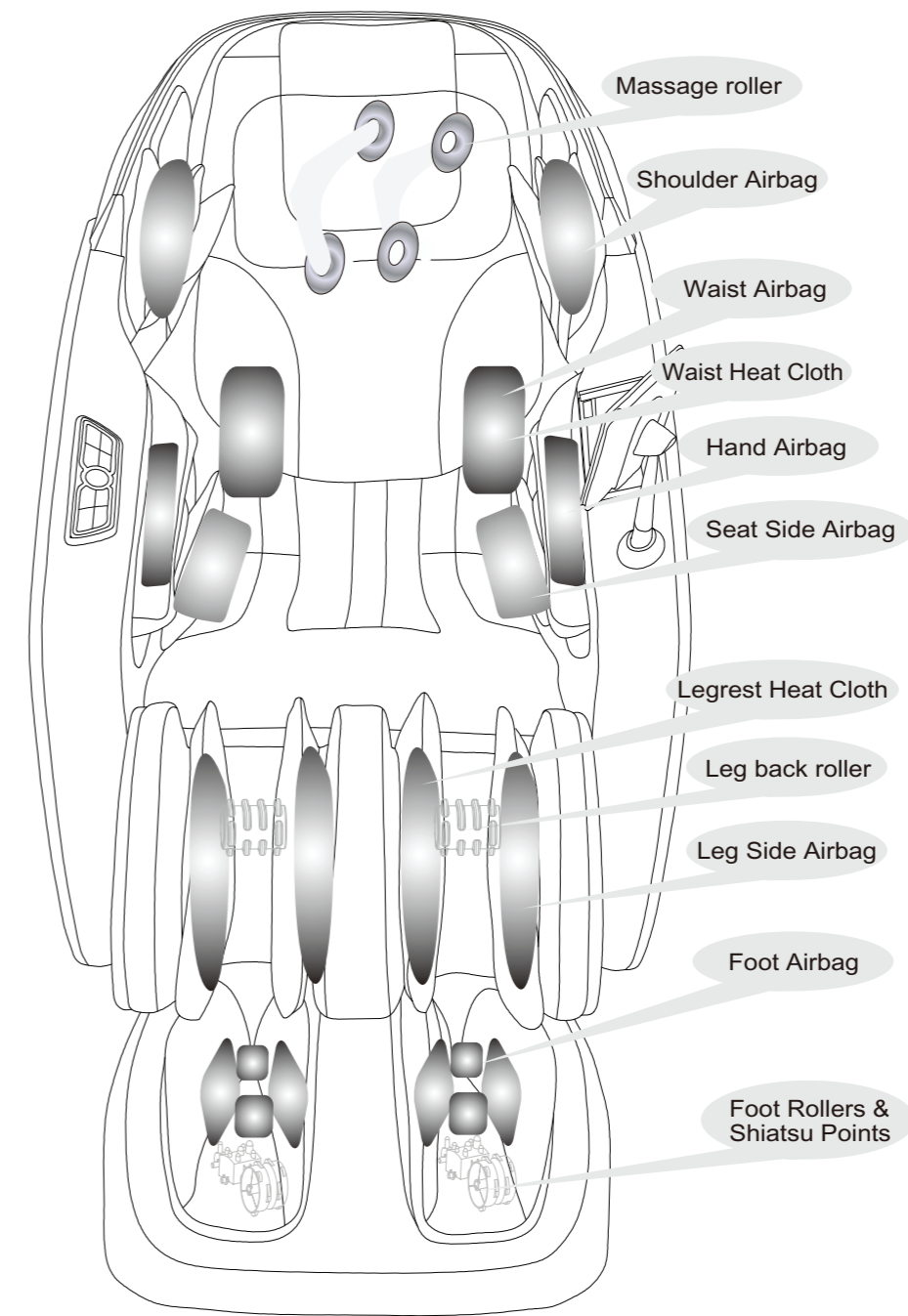

Preparation

Mechanical Explosive View

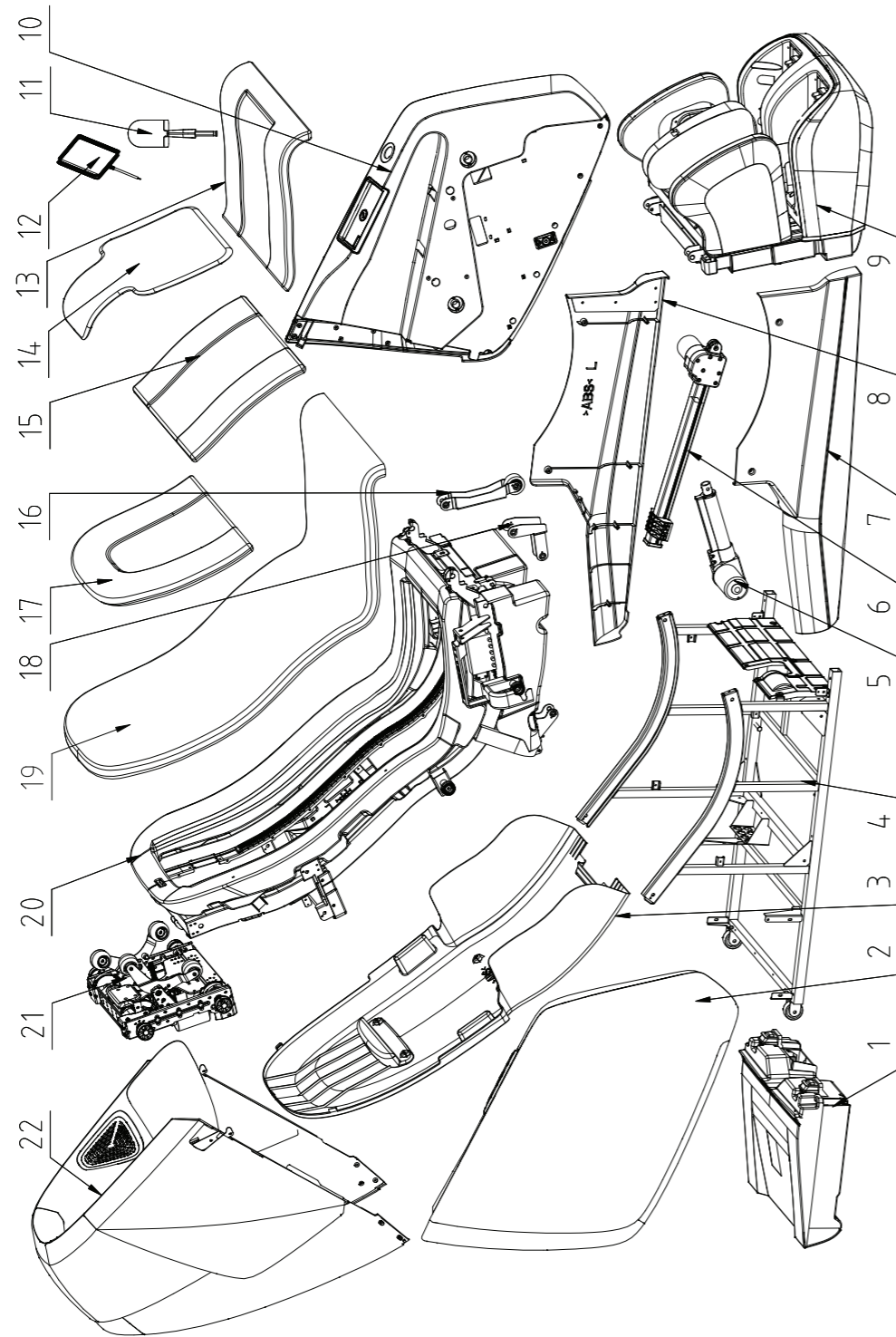

Preparation

Mechanical Components List

NO	NAME	PIECE	NO	NAME	PIECE
1	Power Box Assy	1	22	Shoulder Assy	1
2	Right Armrest Assy	1			
3	Backrest Cover	1			
4	Seat Frame Assy	1			
5	Legrest Actuator	1			
6	Seat Actuator	1			
7	Right Fender	1			
8	Left Fender	1			
9	Leg-rest Assy	1			
10	Left armrest assembly	1			
11	Tablet Bracket Assy	1			
12	Tablet Remote	1			
13	Seat Pad	1			
14	Pillow	1			
15	Back Cushion	1			
16	Legrest Actuator	1			
17	Shoulder Pad	1			
18	Actuator Split Ear Seat Component	1			
19	Back Seat Cushion	1			
20	Back-rest Assy	1			
21	Massage Mechanism	1			

Preparation

Installation 1

Step 1 Remove footrest , main body and accessories from the packing box

- ① Hold the left and right sides of the legs and footrest with both hands and lift the legs and footrest out of the seat of the main body

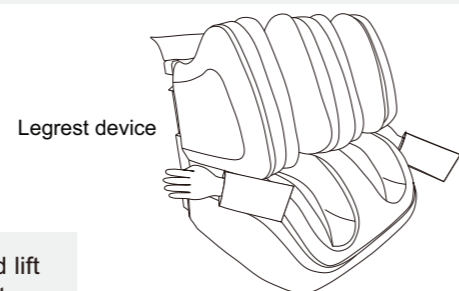

- ② Take out the accessories box and other parts, and lift out the body of the massage chair by more than two people.
③ Check and confirm whether the attachments are complete (please check one by one against the packing list)

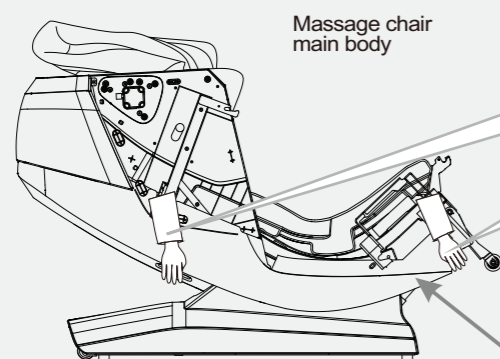

One person holds the handle of the backrest with both hands, and the other person holds both sides of the lower backrest with both hands and slowly lift it out.

Note: It is forbidden to move this location

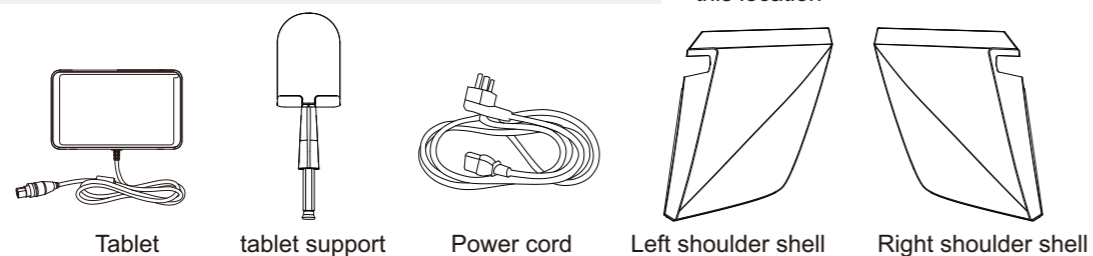

- ③ lift out the left and right armrest put the armrest flat on the table or the ground. (Be careful not to scratch).

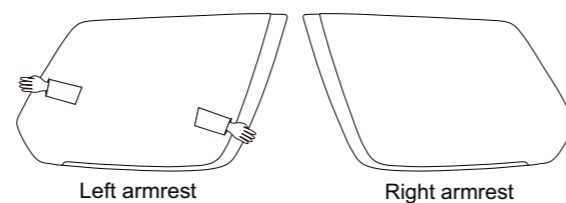

Installation 2

- **Decide the setting place.**
 - Please make sure you can tilt the space.

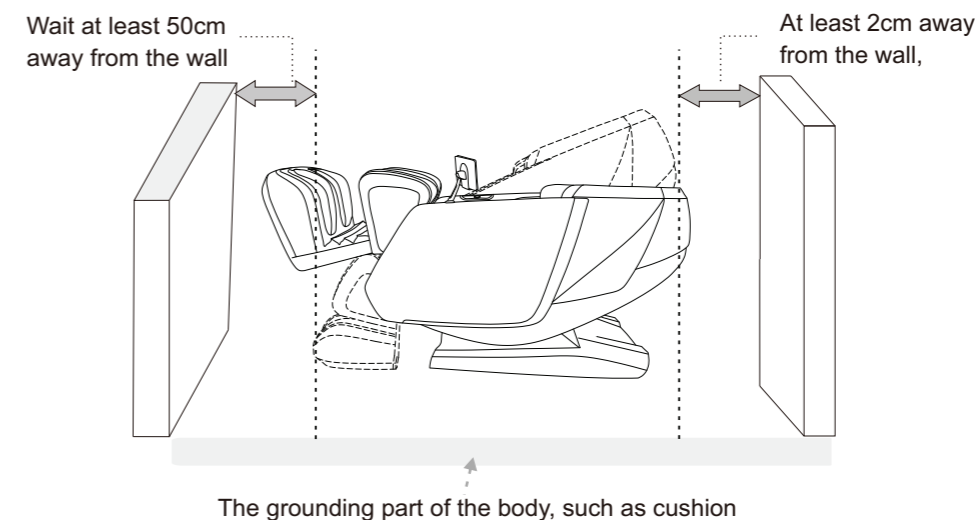
**Hint:**

because sometimes can damage the floor, so it is recommended to lay cushion under the body, etc. When laying, prepare a mat that can cover the ground part of the body.

Attention:

- Do not use or store the product in swimming pool, bathroom or other particularly humid environment.
 - To prevent leakage, electric shock or failure.
- Please use on a level field.
 - Prevent accidental dumping of the machine.
- Do not close to the stove or placed around the heater and other greenhouse appliances.
 - Can cause fabric fading, discoloration or synthetic leather hardening deterioration, etc.

Installation 3

Step 2 Reset the massage chair

① Insert one end of the cable into the power box jack, the other end into the power socket, turn on the switch on the power box, the massage chair is in powered status. ② Insert the concave position of the remote plug to the remote cable socket convex position of the left of the seat, insert tightly then twist the nut tightly. ③ Turn on the on/off button of the tablet remote, then turn off, now the backrest is upping and the seat is downing. Put the remote on the seat temporarily after the backrest is reset. ④ After the backrest is reset, please turn off the switch and unplug the power.

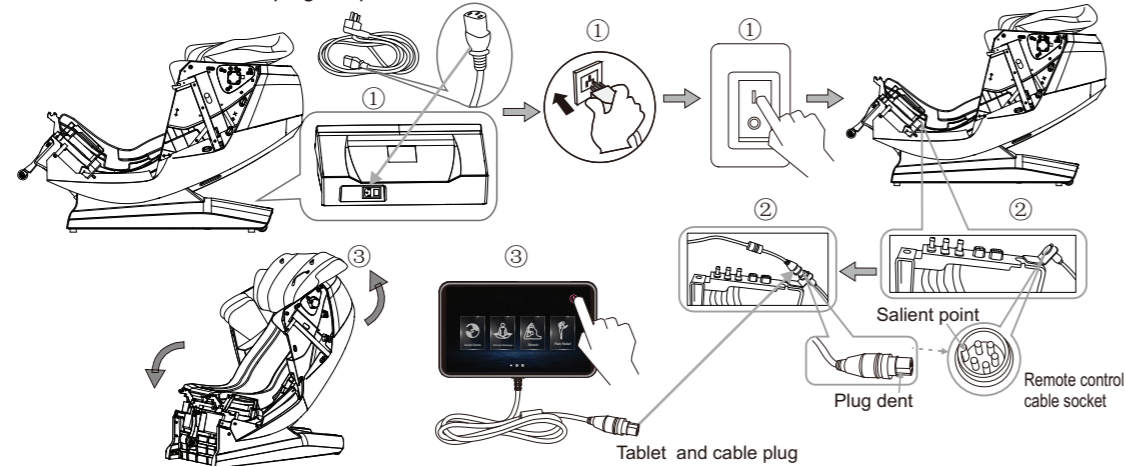

Step 3 install the left, right shoulder shell

Put the right shoulder shell close to the chair shoulder outside;
 ② Insert the 6 buckle cavities and the 3 buckles of the shoulder shell inside to the 6 buckle joints and 3 buckles of the chair shoulder outside, move the wire harness out from the shoulder shell along the notch on the outside of the shoulder shell at the same time, push the shoulder shell inward hard to make sure the buckle insert firmly.
 ③ Install the left shoulder shell in same way (there is no wire harness)

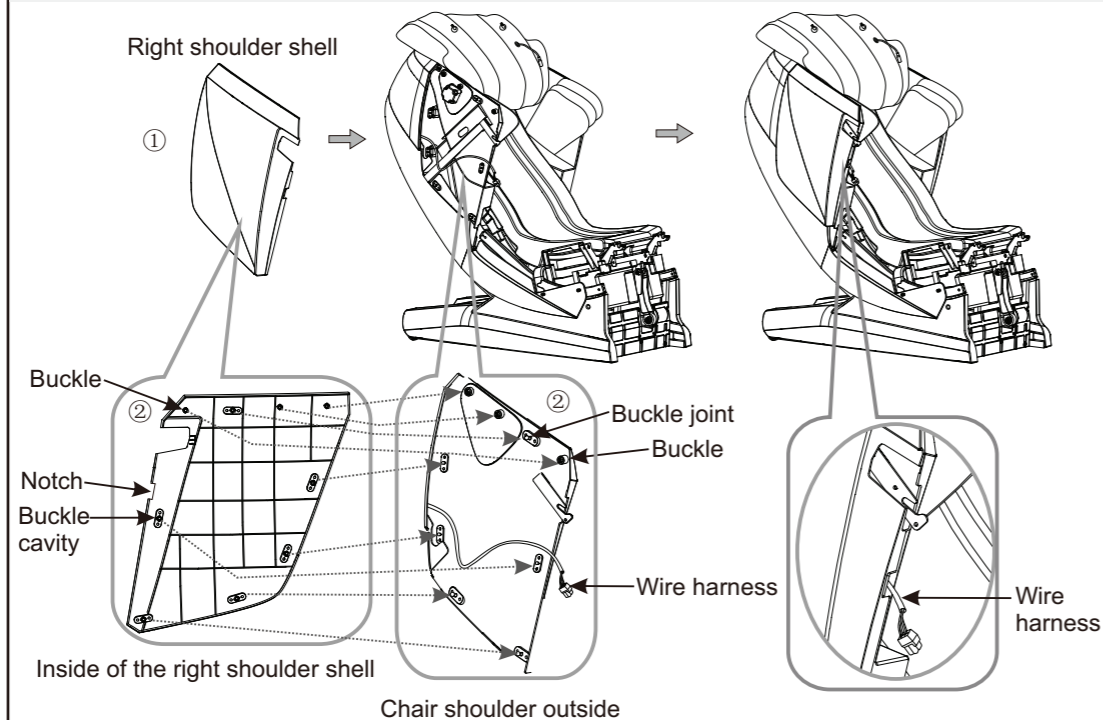

Installation 4

Step 4 Install left and right armrest

① Twist down the two M6*20 screws on the front end of the iron frame on both sides of the seat. ② Put the right armrest close to the side of the main machine, insert the side wire harness of the chair shoulder to the wire harness socket of the chair shoulder side. ③ Insert the fixed-axis on the end of the armrest to the card slot pallet on the up of the shoulder side. Insert the stop block into the fixed hole on the up of the shoulder. ④ Insert the fastenings on the bottom of the armrest to the card slot pallet on the side of the seat frame; ⑤ Insert firmly the air tube of the armrest to the seat air tap, and insert firmly the wire harness. ⑥ Aim the fixed panel on the side of the armrest to the fixed shelf hole on the side of the seat frame, then twist one M6*20 screw+big gasket with Phillips screwdriver and twist firmly. ⑦ Install the left armrest follow the above steps, there is no wire harness on the left armrest.

Note: Do not squeeze the air tube during installation, otherwise it will lead to air leakage or the air bag will not inflate. Make sure the connection of the fixing plate and wiring harness is firm, otherwise the armrest will fall off or the convenient hand controller, speaker and Bluetooth will not work.

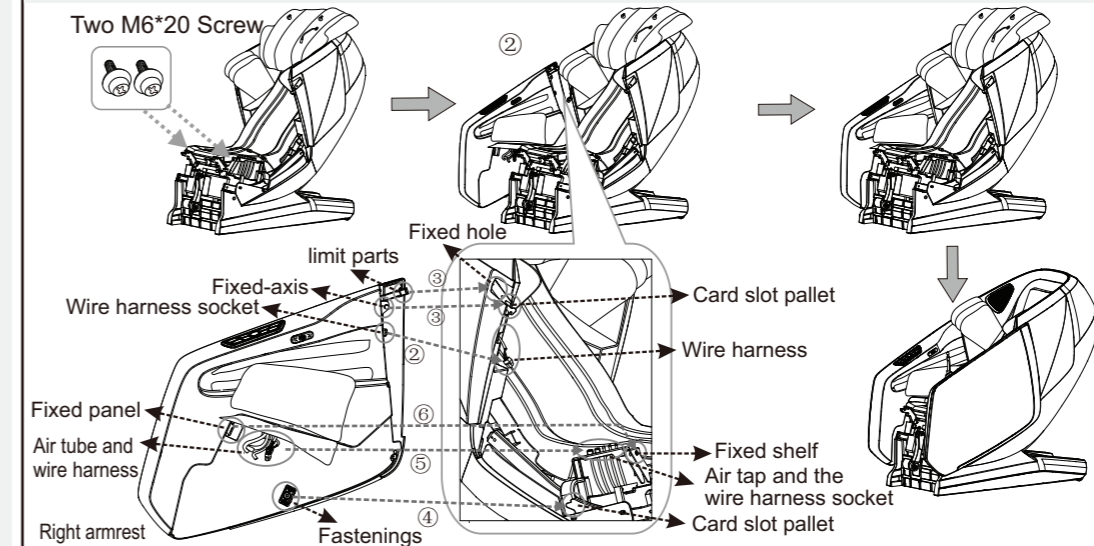

Step 5 Install the legs and footrest.

① Screw down the legs and footrest hanging ears; ② Plug the wire harness into the socket; ③ Connect the air tube of leg-rest with the air nozzle of the main machine firmly; ④ Lift the upper rotating shaft press plate of the hanging lug, lift the legs and footrest, put the rotating shaft into the main engine hanging lug, and put the rotating shaft press plate down; ⑤ Tighten the screw;

Note: When connecting the air pipe and the wire harness, the air pipe and the wire harness should not be wound together.

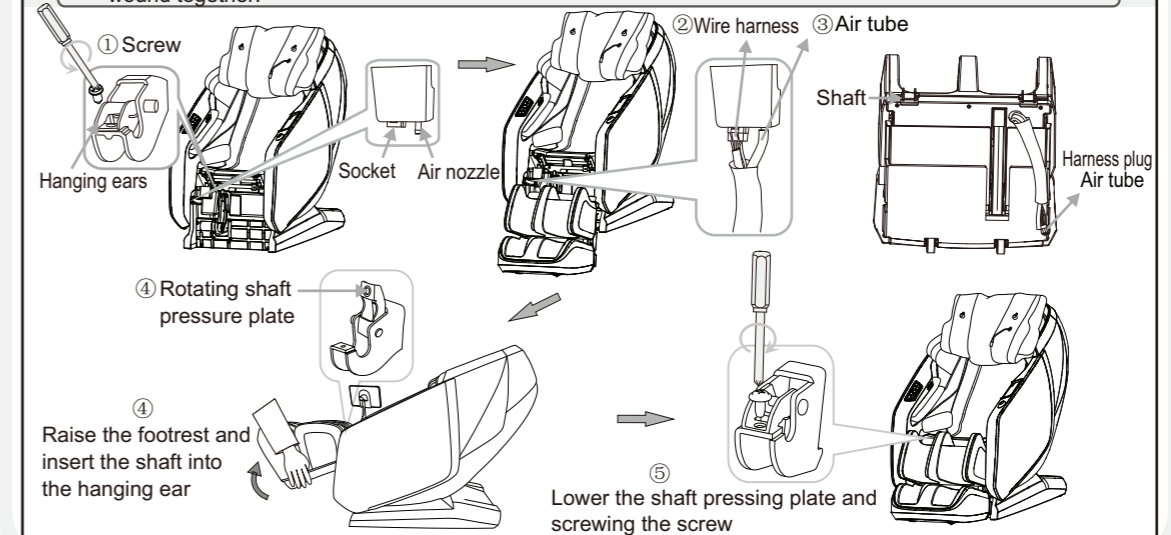

Installation 5

Step 6 Install the bracket of the tablet hand controller

- ① Insert the plate bracket rod into the bracket seat of the left armrest. Insert it according to the shape of the bracket and the shape of the seat hole until the bottom screw of the bracket is stuck in place;
- ② Put the tablet controller into the bracket;

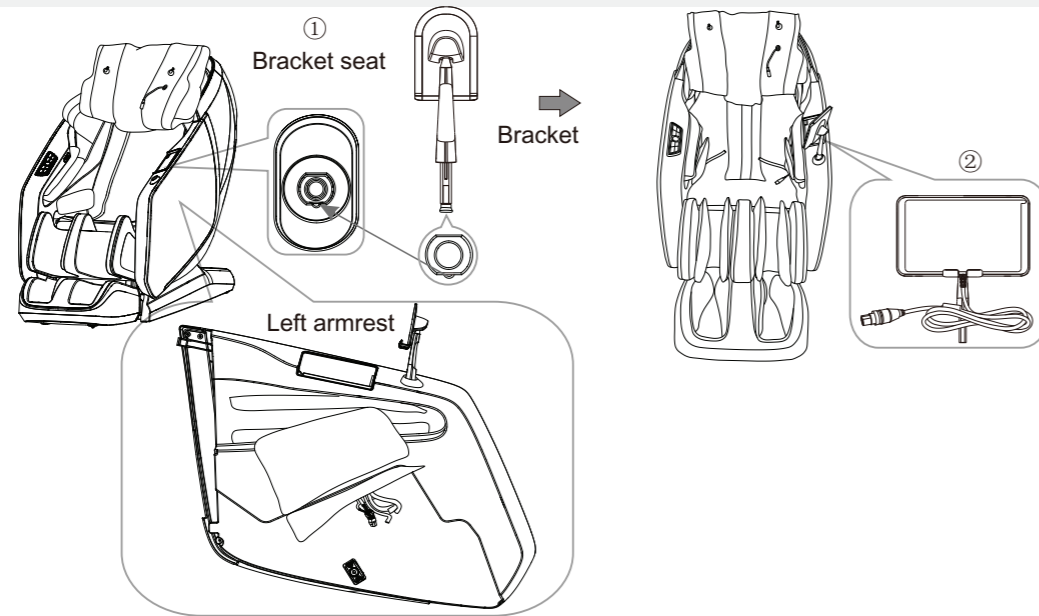
**Step 7 Connect the air pipe with the heating wire and install the back seat cushion**

Connect the seat part and the air tube of the waist airbag; connect the waist heating wire; finally connect the back cushion zipper together.

★ Warm Suggestion

When the people sits on the chair, the bottom of the pillow is level with the ear, and then the pillow is connected with the back of the back. This shape detection will be more accurate, to achieve a comfortable massage effect.

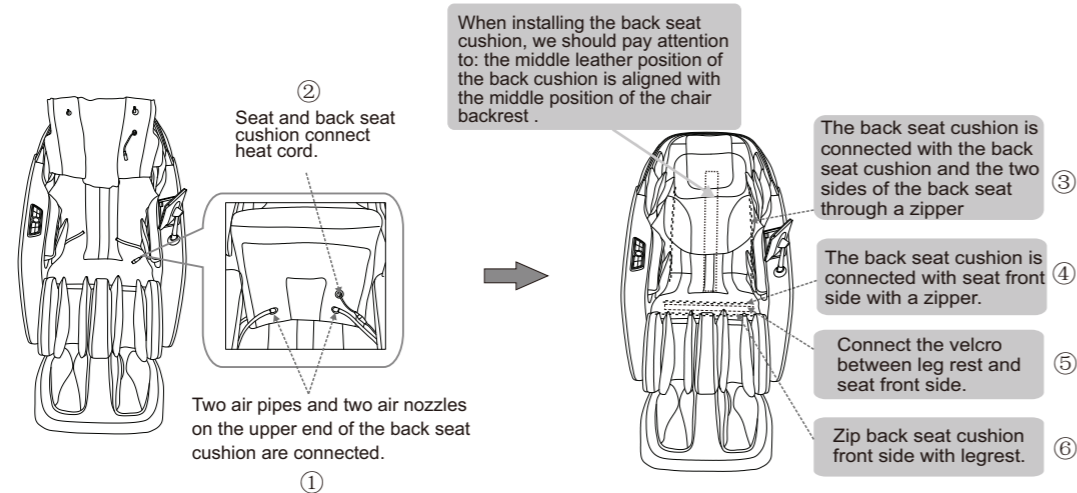

Installation 6

Step 8 Operation after installation

- ① Plug the power plug into the power box socket under the backrest(Picture) :
- ② Insert another power plug from the power cord into the power socket.
- ③ Turn on the power switch at the back of the power box.
- ④ (Power switch "O/I", press I to connect.) Use the handy hand controller on the armrest or the tablet hand controller to choose the massage function, enjoy this product to bring you relaxed and comfortable massage.



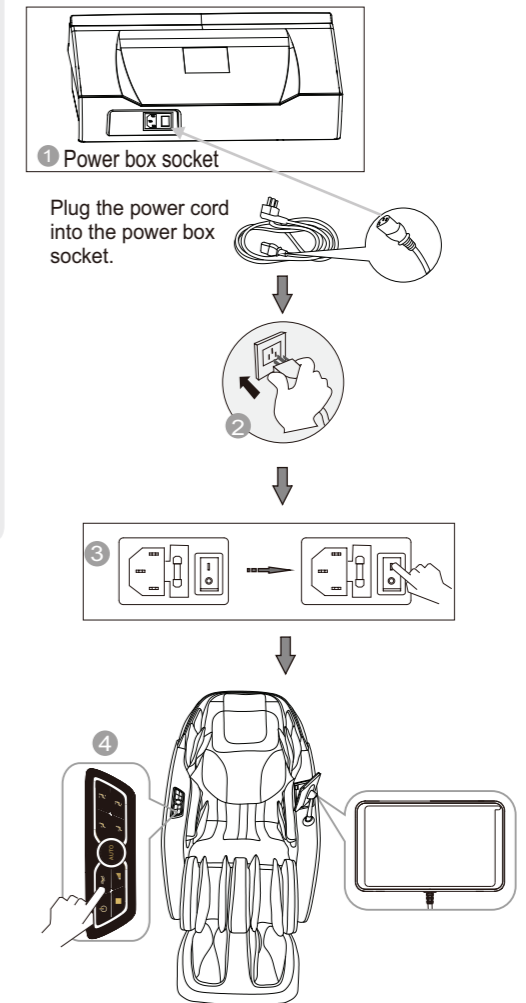

Before connecting the power plug to the socket, be sure to check that the power switch is in the off position.



Environment

 Caution

 Don't use the chair in wet places like near swimming pool, bath room to avoid leakage or electric shock.

 Don't use under sunlight or near stove or other heating place to avoid upholstery deteriorated.

 Please use chair in flat place to avoid chair falling or noise or other unexpected trouble.

● Check places in front

Check the areas when back and leg extending, make sure no people, pets or other things around.

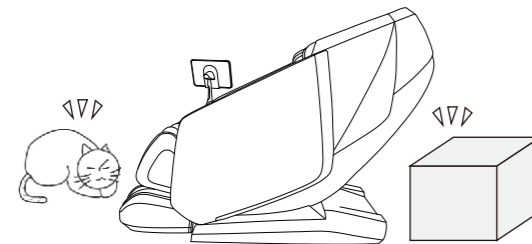

● Check power cable, plug

- (1) Clean the dust on plug on time. (using dry cloth).
- (2) No damage, re-do, bend, stretch, tie or press with heavy thing (especially can't be pressed by the chair) on power cable.

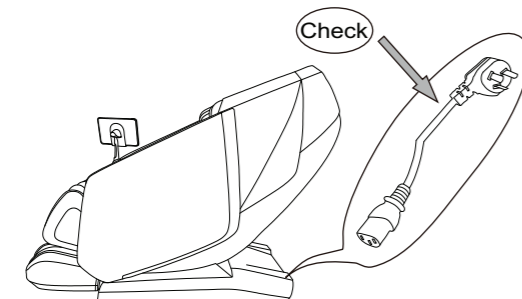

Check environment

● Space size for using the chair

- Zero space from wall.
Tips: at least 2cm from wall.

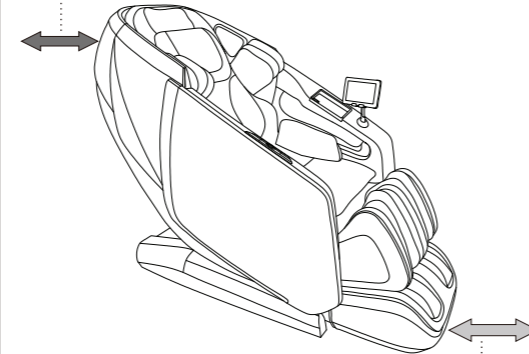

- At least 50cm in front of the leg.

● Check surroundings

When the backrest or legrest reclines or extends, please pay attention to:

- (1) Check any person or things in every direction.
- (2) Check the space size.

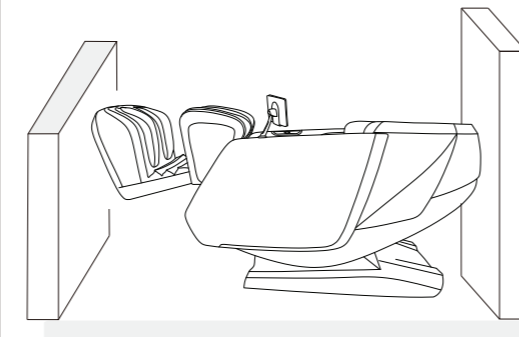
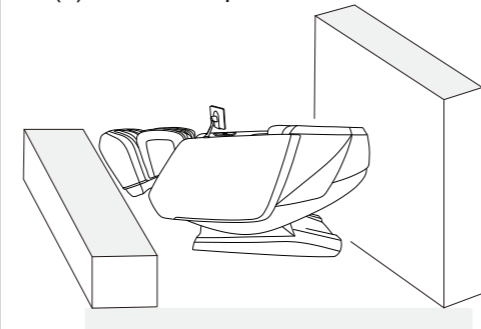

How to move massage chair

 Caution

- ✦ Don't move chair when it's working in case of accidents or damage

How to move

- ✦ Bind the cables and put them in the seat to avoid damage when moving.
- ✦ If you plump the chair, it may damage the inner parts of the chair.
- ✦ Don't use the castor if the floor is wooden or other easy damaged material. It will need 2 or more persons to lift the chair.
- ✦ Make sure the power is off and the plug doesn't touch the floor (It's better to let the chair in standing status to avoid the back crashing the floor)

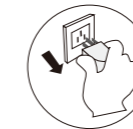

Normally

- 1 Press down the head part to make the gravity fall on the back castors. Then push the chair to desired destination steadily and set it down slowly.

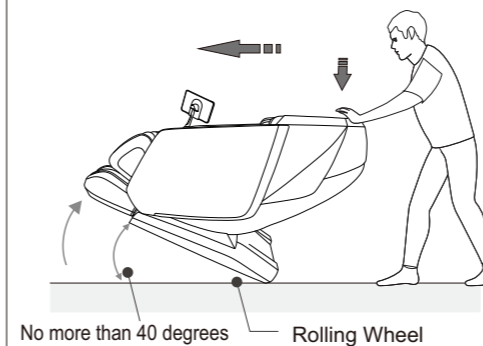

 Please hold the footrest to move the chair as shown in the picture in case any scratches on the leatherette

During massage chair backrest lie down process, can't move the armrest.

Adjustment before massage

● Before adjustment

- ✦ Please confirm the position of the massage head before sitting down slowly.
 - ✦ Avoid injury caused by improper position of massage head.
 - ✦ Acupoint pulse tracking detection and confirmation
When detecting the position of acupoint pulse, if the massage head cannot detect it, the shoulder should be in the middle position by default.
- Proper posture: please put your back against the back of the chair and lean your head back on the pillow cushion.
- When the position of acupoint pulse is automatically measured, the hand controller will prompt.
- When the prompt of "adjustment of shoulder height position" appears on the hand controller, if the shoulder height needs to be adjusted, the shoulder height can be adjusted according to the up and down arrows on the interface.
- ✦ Avoid massage head on your acupoint pulse position detection is not accurate, affect the comfort of massage.

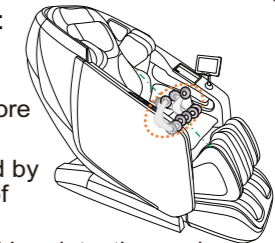

● Kind suggestion

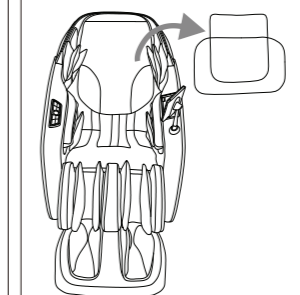

- When you feel the massage strength When not enough, please remove the pillow and shoulder pads, and then massage.

- Because the chair is heavy, it may ruin your floor in long time setting. Please put a blanket or other soft things to protect your floor.

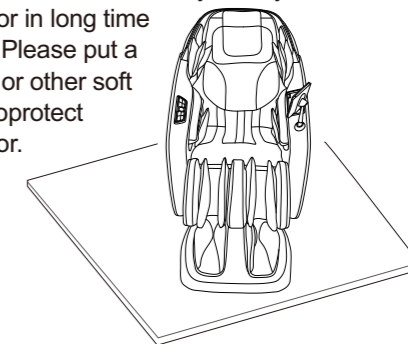

Built-in Remote Instructions

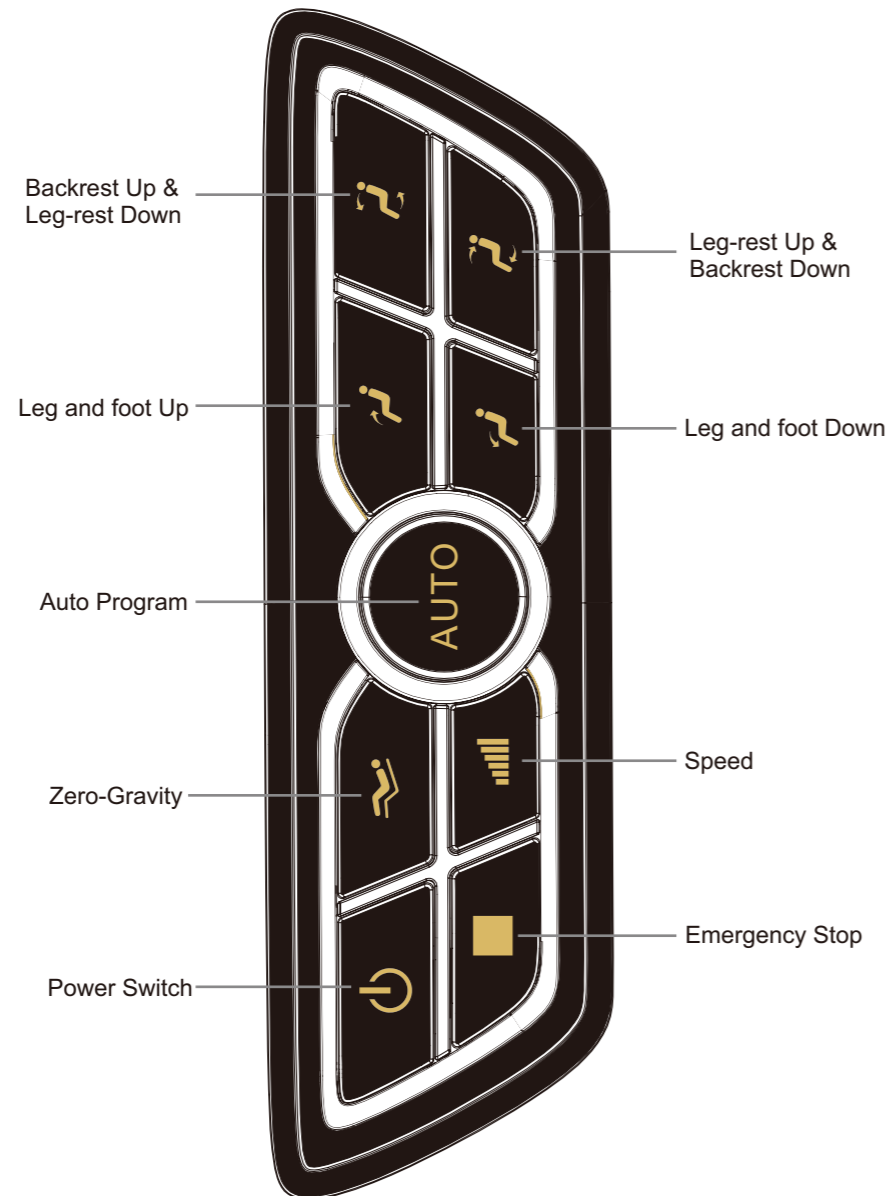

Tips: When the following functions are enabled, the tablet hand controller will display the status synchronously.



1. In the standby state, press the power on key for about 3 seconds, and the massage chair will enter the boot state; In the boot state, when the massage chair needs to be turned off, press the power switch for about 3 seconds to reset the massage chair. If you're in an emergency stop state, click the power switch to turn off the massage chair when confirming that there is no danger.



2. In the power-on state, press this key continuously to loop in 4 angles of zero gravity 1, zero gravity 2, Sleep Mode, and Reset Mode. Except for the Reset Mode, when the other three angles are running, the button is blue. The tablet will go to the pose adjustment interface.



3. Press this button to stop the current operation and the power indicator and emergency stop indicator blink in the boot state; Press the power button to shut down, other keys are invalid.



4. Under manual operation, press this button to adjust the speed of kneading, tapping, beating and kneading; A total of five grade Speed adjustable. Tablet handheld interface will have the corresponding speed level icon display.



5. In the boot state, every time press the automatic key to transform an automatic program, the corresponding indicator light, and in There is corresponding display on the screen of tablet manual controller; There are five automatic massage procedures: TCM health preservation, pain relief Harmony, muscles and bones stretch, longevity health care, fast relaxation. When the automatic massage program is started for the first time after startup, the shoulder height will be automatically detected and displayed during the detection process Refer to the instructions for tablet controllers.



6. In the boot state, press and hold this button, little legs up. Release the button, leg stops running, Angle It's locked in this position.



7. In the boot state, press and hold this button, small leg down. Release the button, leg stops running, Angle It's locked in this position.



8. Hold this key, backrest goes up and leg-rest goes down; release this key, backrest and leg-rest stops moving.



9. Hold this key, back-rest goes down and leg-rest goes up; release this key, backrest and leg-rest stops moving.

Tablet remote control operation

Top surface of tablet remote control ON/OFF button



Tablet Remote Control

LCD Touch Screen

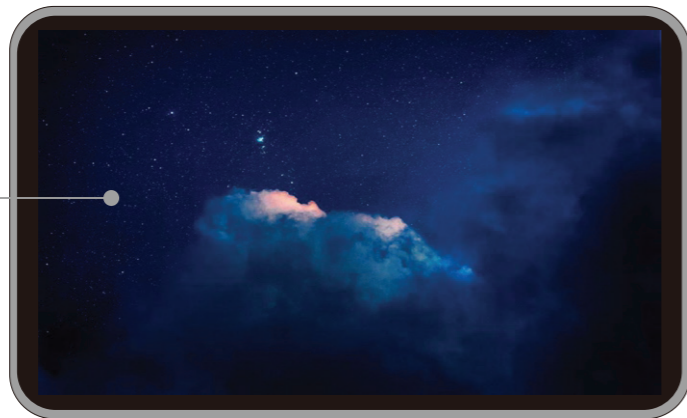

1. After the chair is powered on, the tablet is turned on by default and the boot interface is displayed. Wait a while to enter the main interface, and press the power switch on the top right of the tablet hand controller to turn on/off the tablet hand controller display.

Main Interface 1

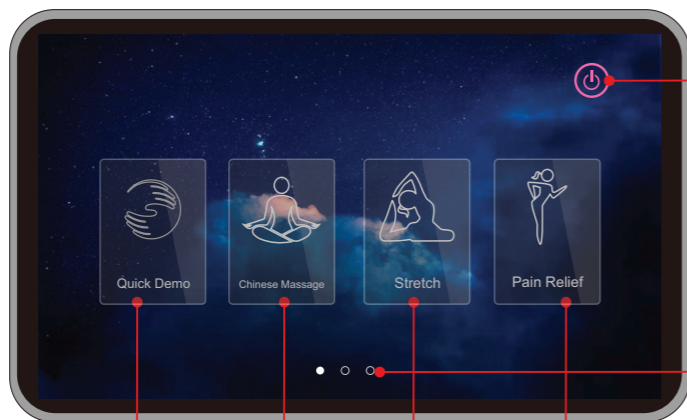

Quick Demo Chinese Massage Stretch Pain Relief

Navigation Icons , Slide left and right to switch the main interface .

Massage operation

Tablet remote control operation

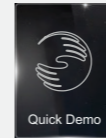

In the ON status, press this icon to enter Quick Demo mode, default working time for this auto program is 8 minutes.

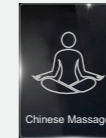

In the ON status, press this icon to enter Chinese Massage mode, default working time for this auto program is 20 minutes.

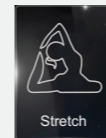

In the ON status, press this icon to enter stretch mode, default working time for this auto program is 20 minutes.

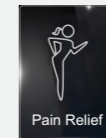

In the ON status, press this icon to enter the Pain Relief mode, default working time for this auto program is 20 minutes.

Main Interface 1

Quick Demo、ChineseMassage、Stretch and PainRelief interface

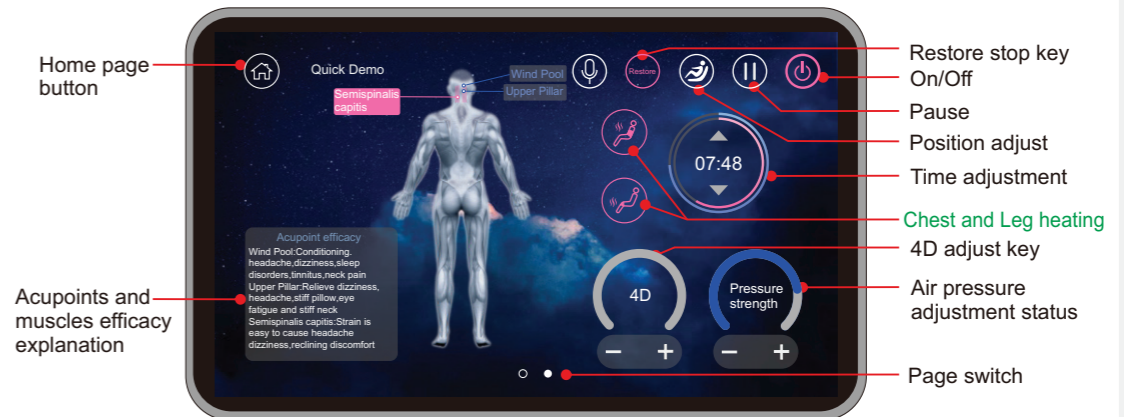

“ On and Off ” button, press it then the icon light up , and turn ON the massage chair can be used.

Position adjustment button, click and enter the position adjustment interface.

Voice Command button, clicking this button, get into the “Voice Command” interface

Chest and Legs heating Butto is turned on in red color, click to turn off the heating and it will show gray color.

4D adjustment button, totally have 5 levels, click the plus and minus signs to adjust.

Showing of Acupuncture points, muscles, movement, Massage position such as air pressure and massage roller and heating state.

“Pause” button, press it and it will light up, then all the massage functions will stop, the interface only have Start and On button can be used, press start button to make the massage functions begin to work normally.

“Restore” After Completion button, clicking to choose it on or off, choose “ON” then after the massage is finish the massage chair will restore itself, choose “OFF” then the chair will not restore itself; except the “Midday” “Night” mode this function is ON by default , all the other auto programs the button light is read and “OFF” by default for this function

“Home page” press this button, return to the home page.

Message time left and adjust button, shows the time left for the current massage function, Up and down arrow key can add or reduce the time.

Air pressure adjustment button, totally 5 levels, press plus or minus to adjust the air pressure, the lowest level is 1 level.

Page Switch button, default is the acupuncture point page, clicking this icon or swipe the human body to switch the display content.

Massage operation

Tablet remote control operation

Position Adjustment Interface

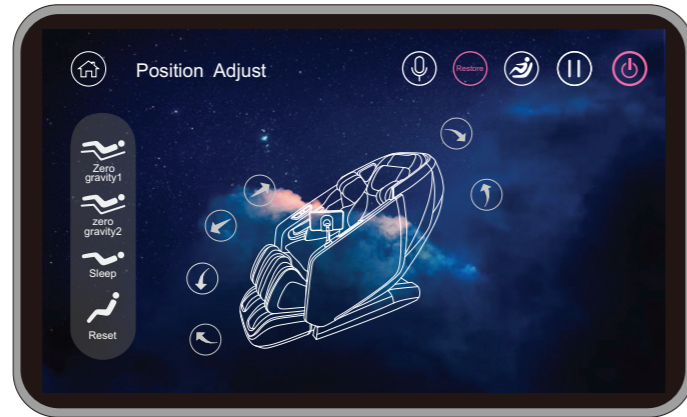

Zero gravity1
 "Zero gravity 1" button, click to light it up and turn on the first level of zero gravity function, the backrest will lie down and the footrest will rise up.

zero gravity2
 "Zero gravity 2"click to light it up and turn on the first level of zero gravity function, the backrest will continue to lie down and the footrest will continue to rise up.

Sleep
 "Sleeping" click to light it up and turn on the sleeping position, the backrest will lie down and the footrest will rise up.

Reset
 "Reset" button , click to light it up and the chair's backrest will rise up and the footrest will fall down.

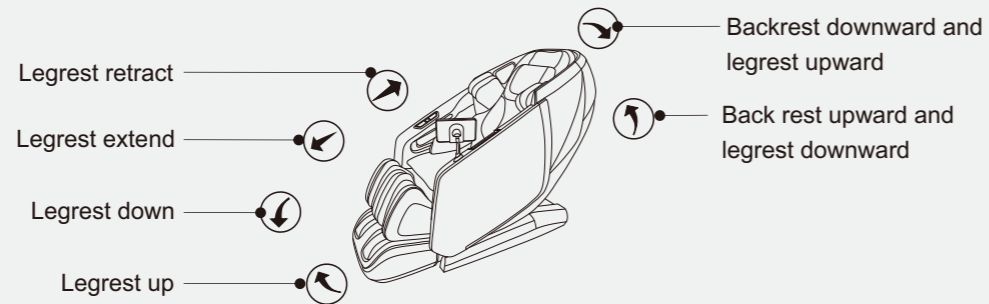

Voice command interface

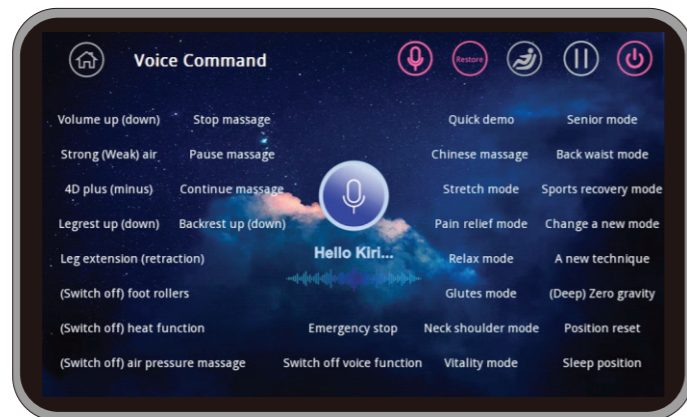

Message operation

Tablet remote control operation

Main Interface2

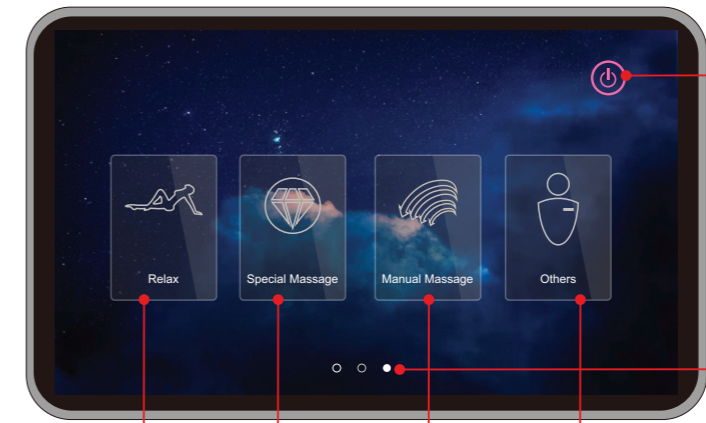

Relax Special Message Manual Massage Others

On/Off

Navigation icon, slide left and right to switch interface.

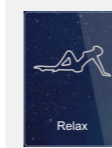

In the ON status, click it the icon lights up, enter into the relax massage mode, the default working time is 20 minutes.

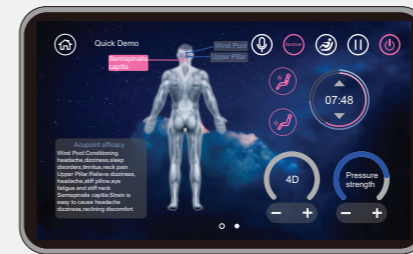

Relax Interface

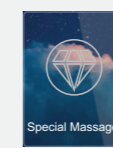

In the ON status, press this icon to enter Special message mode,(For details, refer to special message interface introduction)

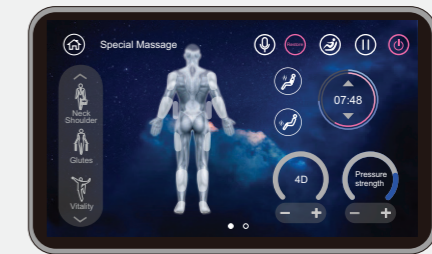

Special Message Interface

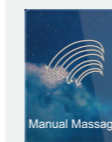

In the ON status, press this key to enter Manual program interface. (See Manual interface introduction for details).

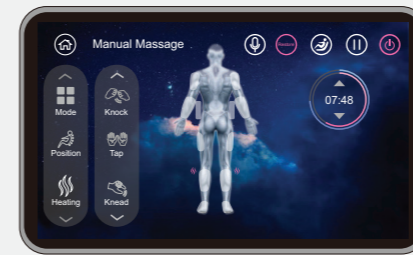

Manual Massage Interface

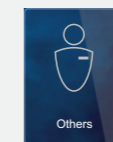

In the ON status, press this key to enter Personal Center interface. (See Personal Center interface introduction for details).

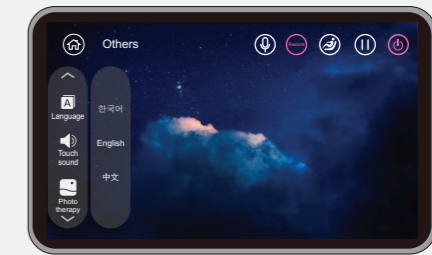

Personal Center Interface

Message operation

Tablet remote control operation

Main interface 2
Special Massage

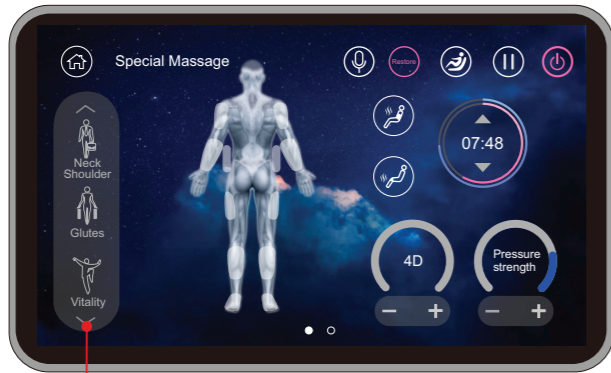

Special Massage Display Area

- Neck Shoulder**
In the ON status, after clicking this button, the icon lights up, the "Neck Shoulder" is turned on.
- Glutes**
In the ON status, after clicking this button, the icon lights up, the "Glutes" is turned on.
- Vitality**
In the ON status, click it the icon lights up, the "Vitality" is turned on.

Massage operation

- Senior**
In the ON status, after clicking this button, the icon lights up, the "Senior" is turned on.
- Sports Recovery**
In the ON status, after clicking this button, the icon lights up, the "Sports Recovery" is turned on.
- Spine Care**
In the ON status, after clicking this button, the icon lights up, the "Spine Care" is turned on.
- Midday**
In the ON status, after clicking this button, the icon lights up, the "Midday" is turned on.
- Back Waist**
In the ON status, after clicking this button, the icon lights up, the "Back Waist" is turned on.
- Yoga**
In the ON status, after clicking this button, the icon lights up, the "Yoga" is turned on.
- Morning**
In the ON status, after clicking this button, the icon lights up, the "Morning" is turned on.
- Night**
In the ON status, after clicking this button, the icon lights up, the "Night" is turned on.

Main interface 2
Manual Massage Interface

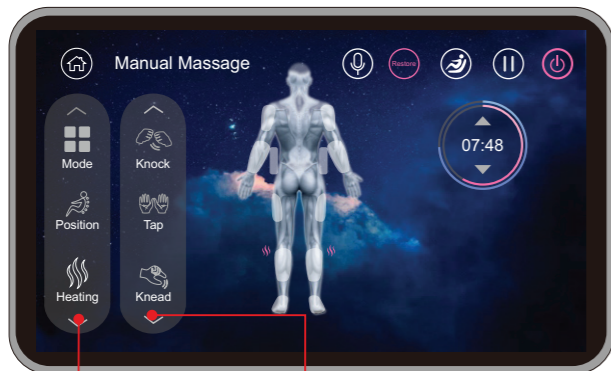

Manual Massage Display Area Mode Display Area

- Mode**
In the ON status, after clicking this button, the icon lights up, one menu will pop up and display Knock, Tap, Knead, Shiatsu, Knead&tap five kinds of massage technique.

Tablet remote control operation

Main interface 2
Manual Massage Interface

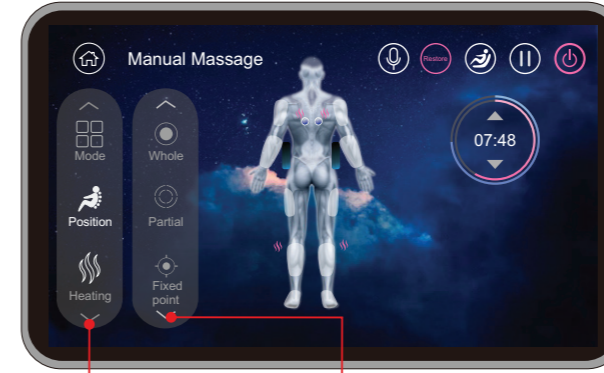

Manual Massage Display Area Mode Display Area

- Position**
In the ON status, press this icon, the icon lights up, the position manual pops up and display whole, partial and fixed point. click the partial button upward and downward key will pop up while the whole and partial key will disappear. Click the fixed point key again, upward and downward key will disappear while the whole and partial key appears.

Massage operation

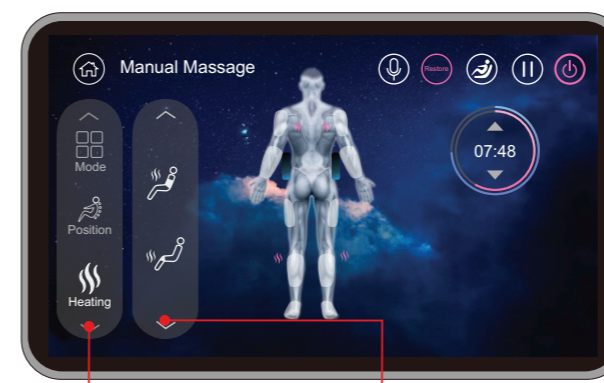

Manual Massage Display Area Heating display area

- Heating**
In the power-on state, after clicking this button, the icon lights up, the heating menu pops up, and displays: Chest heating, leg heating, click each icon to turn on/off the heating function.

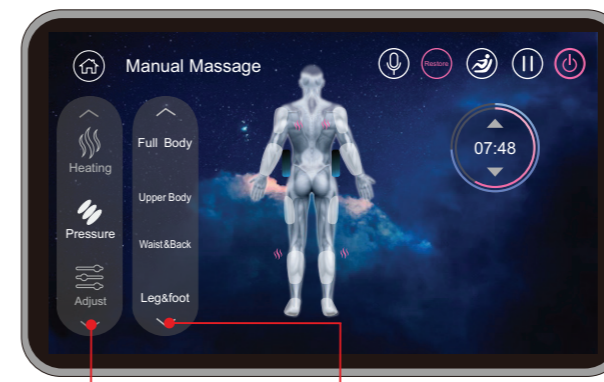

Manual Massage Display Area Air pressure position display area

- Pressure**
In the ON status, press this key, the icon is bright, air pressure massage position manual pops up and displays full body, upper body, waist&back and leg&foot. Click the corresponding button, after the icon becomes bright, you can enjoy the air pressure massage.

Tablet remote control operation

Main interface 2
Manual Massage Interface



Adjust

When the power is on and the massage is running, click this button and the icon will light up, and various adjustment buttons will pop up. You can adjust the massage speed, massage width, time, 4D, air pressure intensity, and roller speed. Back massage speed and air pressure and 4D are 5 levels, 4D width is 3 levels, and foot roller speed is 2 levels. Adjust the level by clicking the plus and minus signs.

Main Interface 2
Personal Center Interface

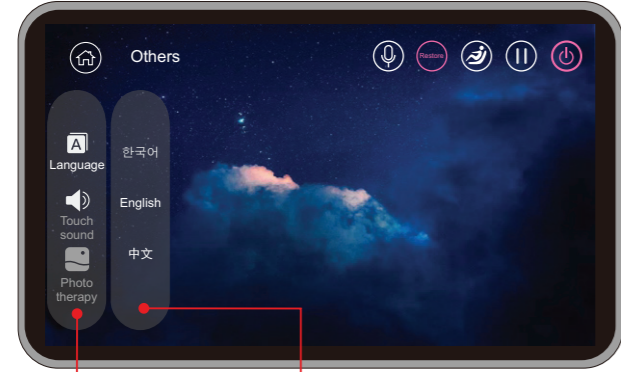

A Language

In the power-on state, click this button and the icon will light up, and the language menu will pop up, displaying Korean, English and Chinese three languages to choose.

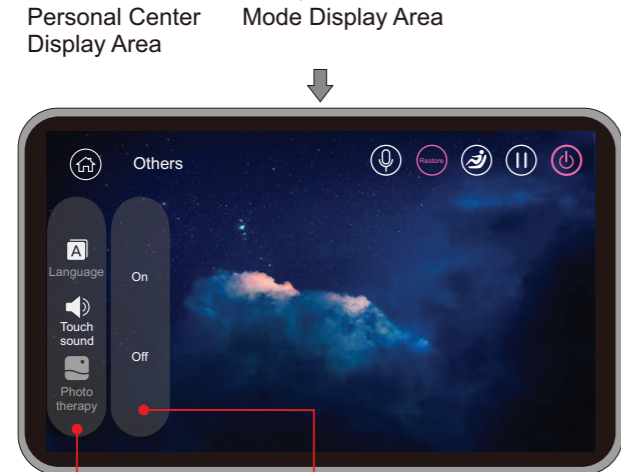

Touch sound

In the ON status, click this icon to light up, to open or close the touch sound.

Massage operation

Tablet remote control operation

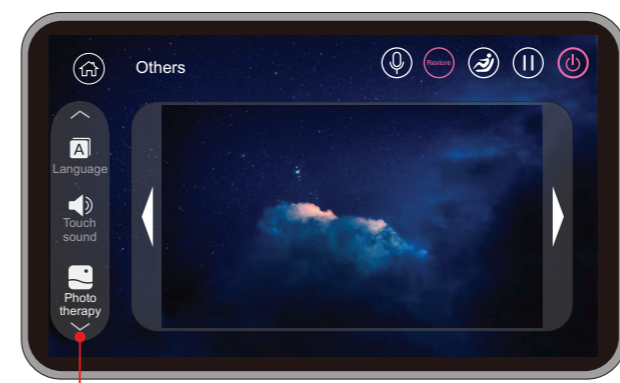
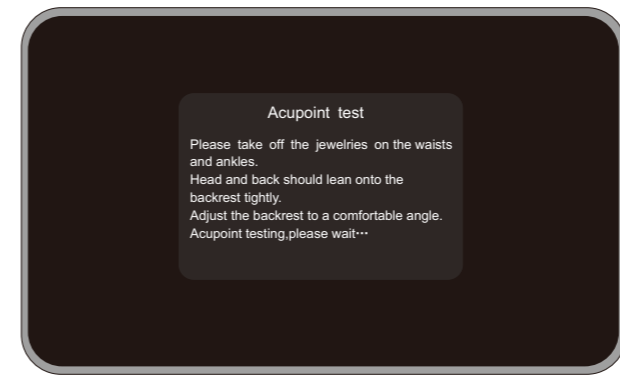

Photo therapy

In the power-on state, click this button and the icon will light up, pop up the background selection menu, switch the background by clicking the left and right triangle keys.

Body scanning interface



Body scanning finished, enter into manual shoulder height position adjustment interface.

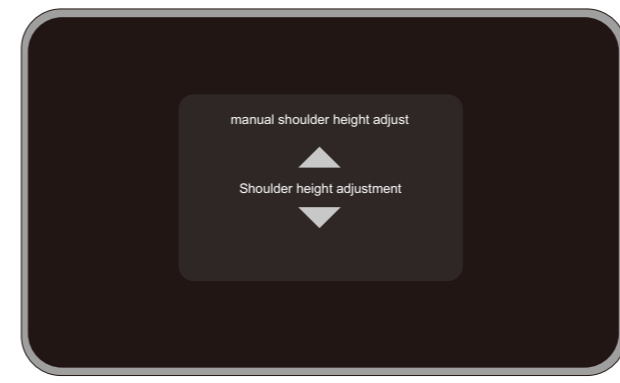

Massage operation

Voice control use method

The use of smart voice control (has voice control function)

In standby state,press the power button of the tablet hand controller or portable hand controller to enter the power-on state, at this time the voice recognition system enters the waiting state.

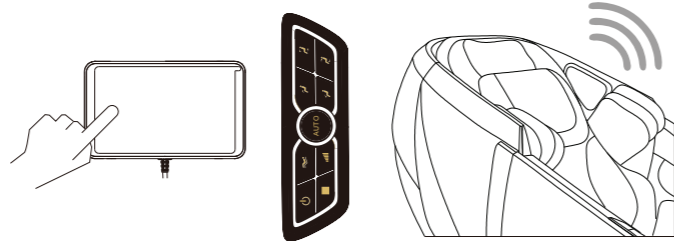

- When use voice recognition function,need to speak "KIRI KIRI",system can recognize the voice command.After the voice mode is turned on, if the massage chair stops massage within 3 minutes, the system will automatically cut off the power,need to re-press the power button to open the voice function.After the massage chair recognizes the command, there will be corresponding speaker voice feedback, indicating that the command is successfully recognized.
Please use standard Mandarin to speak the following voice commands. If they are not recognized, please pause for 2 seconds and raise the volume to speak again.

● Voice command entry:

Voice control
Hello,KIRI
Stop massage
Volume up
Volume down
Quick demo
Change a new mode
Chinese massage
Pain Relief mode
Stretch mode
Neck Shoulder mode
Glutes mode
Back waist mode
Sports recovery mode
Senior Mode
Relax mode
Vitality mode

Massage operation

Voice control use method

● Voice command entry:

Voice control
A new technique
Air pressure massage
Switch off air pressure massage
Backrest up
Backrest down
Legrest up
Legrest down
Leg extension
Leg retraction
Speed up
Slow down
4D Plus
4D Minus
Strong air
Weak air
Zero gravity
Position reset
Deep zero gravity
Sleep position
Foot rollers
Switch off foot rollers
Emergency stop
Switch off voice function
Full body massage
Partial massage
Point massage
Rollers up
Rollers down
Make it wider
Make it narrower
Heat function
Switch off heat function
Pause massage
Continue massage

Caution: 1.This function is an intelligence recognizing, support expansible command with key words.
2. This function will be updated automatically, may be revised without reminding.

Massage operation

On/Off

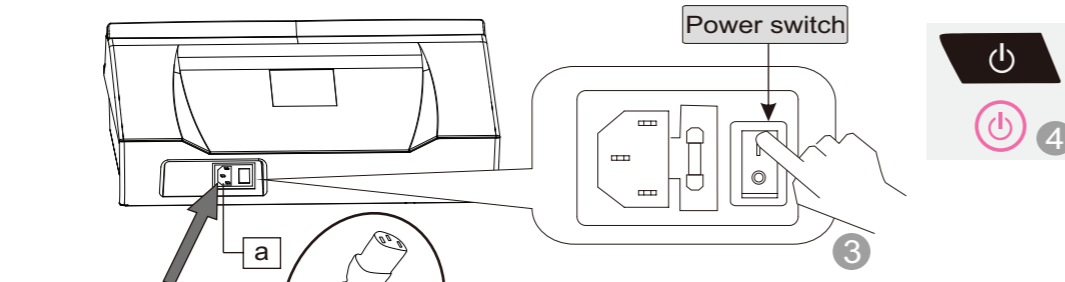

Step 1. Turn on the power

- ① Make sure the A hole is inserted into the power plug at one end of the power cord.
- ② Insert the power plug into the socket.
- ③ Turn on the power switch of power box, massage chair powers on.
- ④ Press "ON/OFF" button of the panel remote or quick keys, massage chair is ready to work, could be operated after reminding interface disappear.

Step 2. Massage

- ① According to the operating instructions of the tablet remote, select the corresponding function massage. For massage techniques detail, please refer to the instructions for using the tablet remote.
- ② After the massage is over, the massager is reset, and the tablet remote show it is shutting down.

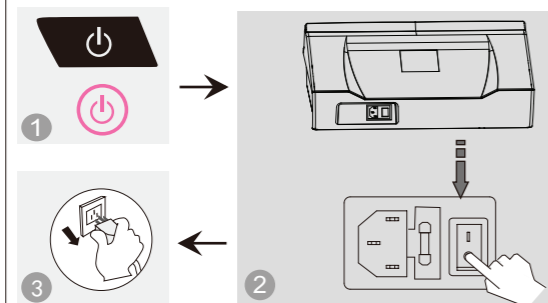
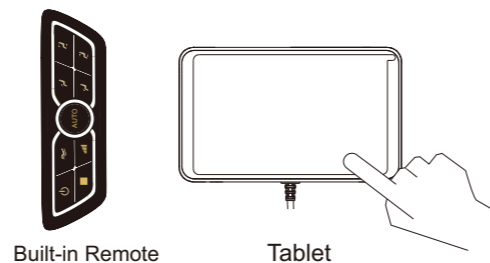

Step 3. Turn off the power

- ① In the shutdown state, press the tablet remote panel button again to turn off the machine, and the machine will automatically store it.
- ② After the storage is finished, turn off the power switch on the power box under the backrest.
- ③ Finally, unplug the power plug from the socket.



Warning

- ① Please lift up the pillow cushion and back cushion before use them, to confirm whether the fabric of the backrest part and other parts are damaged. If there is any damage (no matter how small the damage), please stop using it in time, unplug the power socket, and perform entrusted maintenance.
- ② Only connect the machine plug to a suitable power outlet.



Watching

- ① Before sitting down, make sure that there are no foreign objects caught in the machine (including the armrest, legs and feet, backrest and seat, etc.).
- ② The feet are equipped with safety protection devices, when there is a foreign body between the legs and feet, the feet automatically stop retracting.
- ③ Make sure that the massager is in the storage place then sit down.
- ④ Please do not stand on the machine during use it.
- ⑤ The power box upper cover is equipped with a safety anti-pinch device. When there is a squeeze between the power box and the back cover or there is a heavy object on the power box upper shell, the backrest will stop lifting.

Function Illustration

● Legrest Up

Press this button on controller, legrest goes up. Release the button, legrest stops moving, the angle is locked in this Position.

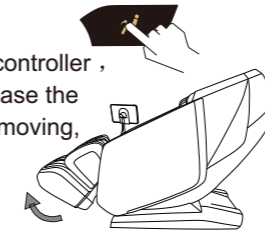

● Legrest Down

Press this button on controller, legrest goes down. Release the button, legrest stops moving, the angle is locked in this position.

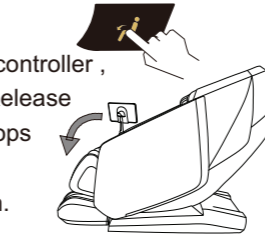

● Legrest up and backrest down

Press this button on controller, backrest goes down and legrest goes up. Release this button, backrest and legrest stops moving, the angle is locked in this position.



● Backrest up and Legrest down

Press this button on controller, backrest goes up and legrest goes down. Release this button backrest and legrest stops moving, the angle is locked in this position.

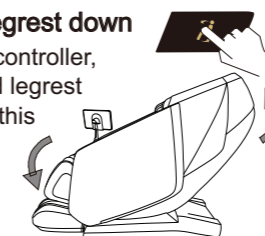

● Legrest extend and retract

When legrest get up to an certain angle above the ground, its length can be adjusted into a suitable one by extending and retracting within 19cm automatically.

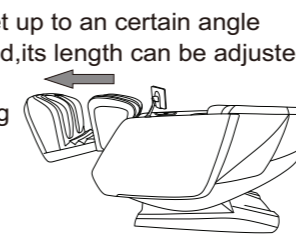

● Zero-gravity

Press the hand control "Zero-gravity" button to adjust the massage chair pose for comfort the zero gravity state, even Continuing to press this key will loop and reset the Zeo Gravity 1, Zero Gravity 2, Sleep mode, Reset mode, total 4 angles. The interface of tablet controller will display the corresponding zero gravity icon. It can effectively relieve the pressure on the spine and joints.



★ Tips:

Zero gravity is based on the NASA space capsule relaxation principle, through the three-part multi-angle change combination of the back, seat, and legs, and make the legs raised and the seat sunk, so that the elevation angle between the body and the legs is 128 degrees/ (+/-7 degrees), keeps the heart and knees in the same horizontal level, the blood circulation pressure is reduced, and the body pressure is moved into the buttocks. At the same time, due to the zero gravity angle design, the touching area of the human body and the massage chair is increased, so that the pressure on each part of the body is evenly distributed to the massage chair, reducing the pressure on the heart and spine, and realizing a comfortable relaxing, natural and comfortable massage posture.

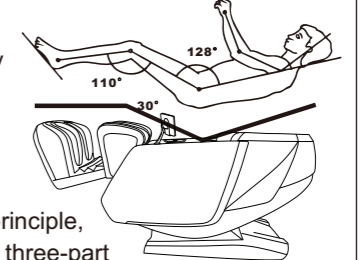

1. Please make sure there is no people, no pets or any stuff around the backrest to avoid unexpected hurt or property loss.
2. When adjusting the backrest, be careful of the gap between the backrest and armrest.
3. When the legrest is moving, please do not stand on or leave from the seat, do not stop the legrest from moving in case of causing damage to the chair.
4. Please refer to control instruction for more details

Function Illustration

● Arm Massage

The armrest has built-in pulse pressure massage function to realize the pinching of the arm and the finger pressure of the palm acupoints, improve the blood circulation and relieve the numbness of the hand.

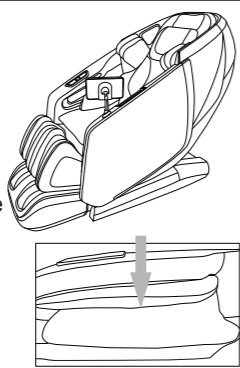

● Shoulder Massage

Multi-layer extrusion airbags is deployed on both sides of the shoulder, Achieve pressure shoulder stretch massage, relieve shoulder fatigue.



● Waist Heating Function

Traditional Chinese medicine hyperthermia is used in the waist to promote human blood circulation, relieve waist pain, and care the spleen and stomach.

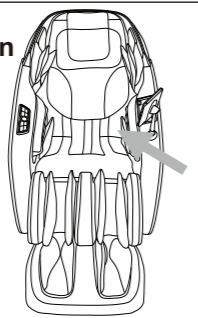

● Foot Roller Massage

Footrest parts with roller massage and air pressure massage function, Through stimulating the foot reflex zones, and clear the body meridians, human organs function, improve the body resistance and immunity effectively.

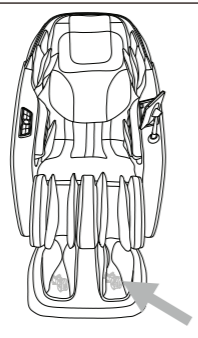

● Calf rubbing Function

The innovative calf rubbing technology provides kneading and rubbing in leg position, combined with calf rolling, heating and pulse air squeezing, the leg muscles will be massaged sufficiently to prompt the blood circulation, and effectively relieve the leg aches and restore the energy on the muscles.

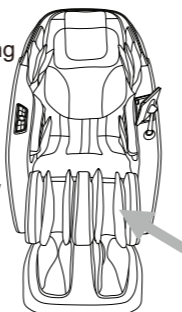

● Foot Safety Anti-Clip Function

When the footrest angle is being adjusted, the massage chair can automatically detect the length of human legs, do not put your feet on the out cover if footrest now, otherwise it will affect the detection of the leg length, resulting in retraction failure of the footrest. Also, there is anti-pinch reminding on auto program interface of tablet controller.

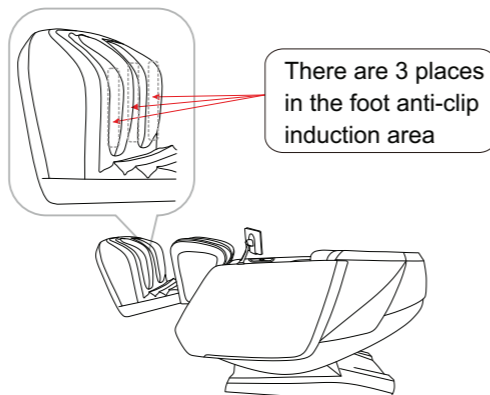

When the massage chair is turned off, do not put your feet or any parts on your feet face, or the foot retracts to stop; In this state the chair continues reset, the legs and feet can not be collected to the original position.

Note: When the power is turned on, the massage chair should be fully reset. Turn on the machine again, otherwise it will cause the anti-clamping function to fail.

The power box have the flowing anti-pinch function, if there is heavy obstacle pressed the cover of power box, the backrest will stop declining, and continue to decline after heavy obstacle removed.

Restoration of the massage chair

- 1 Confirm whether there are people, pets or other items in the movement range of this chair's backrest or leg-rest.

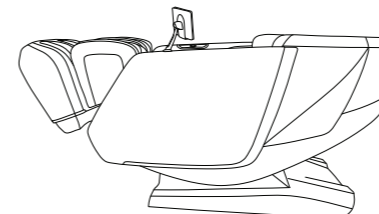

- 2 Use a manual controller to slowly restore the backrest and legs to their original position. (Or to directly press the "switch" button off can also make the backrest and leg-rest slowly return to their original position.)

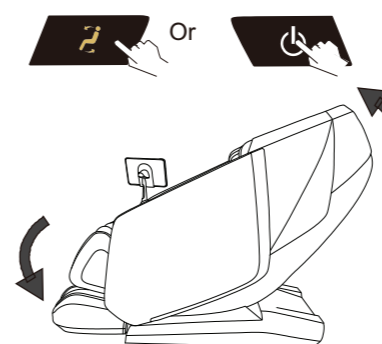

- 3 After being stored, put the hand controller back on the plate of the left armrest stents.

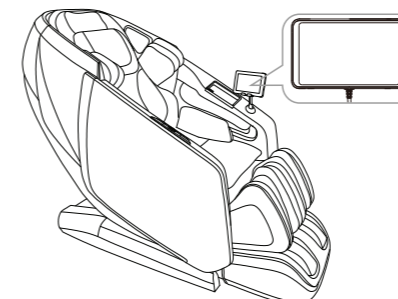

- 5 Turn off the power switch.

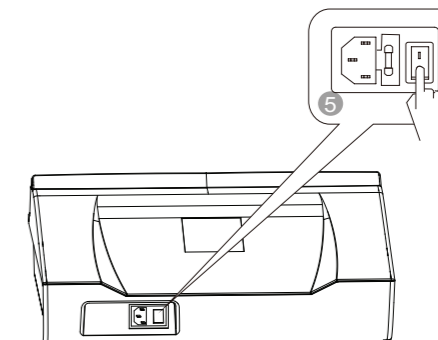

- 6 Unplug the power plug from the power socket. (Attention: hold the right plug position)

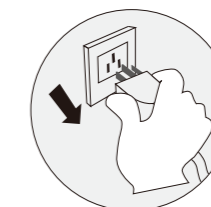

- 7 Do proper tidies and cleaning.

! Attention

- After the massage, press the "on/off" button to turn off all the massage movements and wait for the massage rollers to be collected and put in place. After use, make sure the power supply is disconnected to avoid mischievous. Accidental injury to children or other pets.
- After use, turn off the power switch, pull out the power cord plug, Environmental protection and energy saving. Avoid pulling the power plug by pulling the power cord alone. Avoid damage caused by moisture, dust and degradation of insulation.

Synthetic leather

● **General cleaning**

Clean with tidy, soft and dry cloth slightly.



(Chemical or medical cleaning products are forbidden)

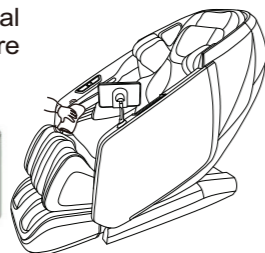

● **If leather is dirty**

- 1 Dip soft cloth into 3-5% neutral detergent solution, squeeze it then clean the stain on the surface gently.
- 2 Wash cloth, squeeze it and wipe with detergent.



- 3 Clean it softly with dry cloth.
- 4 Allow to dry (air blower is prohibited)

Cloth material

- 1 Dip cloth into weak neutral detergent, squeeze it and clean the material surface.

- (Diluent, gas, alcohol are prohibited)
- Brush the dirty parts with weak neutral detergent. (avoid excessive brushing)



- 2 Excessive cleaning may cause damage to cloth material.
- 3 Wipe with water-dipped but squeezed cloth.
- 4 Allow to dry.

Plastic parts

- 1 Dip cloth into neutral detergent, squeeze it and clean.
- 2 Wipe with water-dipped but squeezed cloth.
- 3 Allow to dry.



Clean the controller

- 1 Wipe with soft cloth after squeezing.
- 2 Allow to dry. Propellant, diluent or alcohol are prohibited.

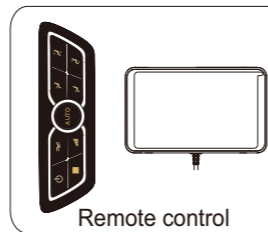

About cleaning

- Before cleaning, unplug the electricity, don't touch plug with wet hands.
- Make sure hands are dry when plugging to the socket.
- If failed to follow the mentioned instruction, user may get electric shock or burned.

FAQ and Troubleshooting

Trouble	Possible reason	Troubleshooting
The massage chair can't work after power is on.	Check if the control is on or not.	Open control switch
	Not choose massage function	Choose massage function
	Check whether the plug and socket in poor contact.	Make sure plug and socket are connected.
	Wire or plug has damaged.	Please ask manufacturer or appointed or authorized maintenance man for checking and replacement.
	The fuse burned out.	Replace fuse of same specification.
There is beep sound inside the massager while working.	Something wrong with inner circuit	Please ask appointed or authorized maintenance man for checking and repairing.
	It is sound of air pump, motor and mechanical parts.	Normal sound, no need to pay attention to it.
Different height of the left roller and right roller.	Massage rollers work on shifts.	Normal, no need to pay attention to it.
Sound suddenly becomes much louder while working.	Check if it is due to long time working.	Turn off the power to have the massager rest for over half an hour before next turn working.
	Inner parts fretted away due to long time work. It's normal	Please ask appointed or authorized maintenance man for checking and repairing.
Massage function suddenly stops while working.	Suddenly power-down	Connect the electricity power again
	Setting time is up.	Turn off the power to have the massager rest for over half an hour before next turn working.
Neither the backrest nor the legrest can be lay down.	Check if there are any obstacles; the chair overloads; for the sake of safety, sometimes the massage machine may automatically stop working.	Remove the obstacles; turn off the power to have the massager rest for over half an hour before next turn working.
	There is heavy things on power box.	
The chair can't return to its original position.	Excessive operation; setting time is up.	Please ask manufacturer or appointed or authorized maintenance man for checking and replacement.
Electric wire or plug give out heat	It may work overload	Turn off the power to have the massager rest for over half an hour before next round working.
	Other abnormal case	Stop using, and ask appointed maintenance man for help.



Note: If the troubles are not caused by above reasons, please turn off the power switch and cut off the power, then contact the manufacturer or service agent to repair your chair.

Technical data

Name	Massage Chair	Power	260W
Model	OS-Highpointe 4D	NW/GW	Main body :227/267lbs Armrest :28.6/38.6lbs
Input voltage	120V~ 60Hz	Packing size	Main body: 58.5 x 31.7 x 38 inch Armrest : 40 × 16.7 × 24.4 inch (L×W×H)
Safety design	Class I		