

Osaki



Instruction Manual OS-4000

Thank you for purchasing the OS-4000 Massage Chair.
Before using your massage chair, please read the contents of this instruction manual and refer to it when needed.

Table of Contents

Luxury Features	2
Safety Precautions	3-4
Chair Components	5-6
Chair Installation & Moving	7-11
Grounding Instructions	12
Chair Specifications	13
Controller Diagram	14
Operation Guide	15-21
Troubleshooting	22
Warnings	23

01 Luxury Features

The operation of massage chair is controlled by a microcomputer that performs various intelligent massage methods and combinations, like Kneading, Tapping, Clapping, Shiatsu, Rolling, Vibration and Air Massage. All these methods massage acupressure points accurately to effectively alleviate fatigue, promote metabolism and improve blood circulation.

The chair is equipped with five sets of full body automatic programs and three sets of localized automatic programs to thoroughly fulfill your various needs. Various types of massage functions can be combined for customized massaging programs, in addition to the precise point massage.

The combination of air pressure for the seat pad, shoulder, neck, arm and leg as well as the calf and vibration functions can be set automatically for more effective massage.

- Spring-styled massage that is specially structured for the back is designed according to curve of the human body to provide a more effective massage.
- The massage rollers use an interlocking gear to provide in-depth massage to the acupressure points on the back.
- Designed with double automatic adjustment, the chair's backrest can be adjusted from 115° to 160°, while the footrest, from 0° to 90° to suit you.
- Heating therapy in the lumbar.
- The timer function can be adjusted according to your desired duration of the massage program.
- Liquid crystal display and glow-in-the-dark display for a user friendly operation even in the dark.
- Designed with power surge and pressure detector as well as automatic temperature sensor and auto shutdown mechanism for safety.
- The operation is controlled by intelligent microprocessor for excellent performance and consistent quality.

Safety Precautions

When using the massage chair, basic precautions should always be followed to reduce the risk of electric shock, burns, fire or injury to persons. Please read the following precautions before using the massage chair.

- * Make sure the power plug is securely inserted into a proper electrical outlet to reduce the risk of short-circuit and fire.
- * Always unplug the massage chair from the electrical outlet immediately after using and before cleaning.
- * **DO NOT** use the massage chair in areas where the humidity is high such as a sauna or steam room.
- * **DO NOT** use the massage chair outdoors and avoid areas with direct sunlight.
- * If the electricity is off, turn the power switch to the OFF position and unplug the massage chair from the electrical outlet to prevent any damages to the chair when the electricity comes back on.
- * Never plug/unplug the power cord plug socket with wet hands.
- * Close and continuous supervision is necessary when the massage chair is used by, on or near children or disabled persons.
- * No more than one person should use the massage chair at a time.
- * The massage chair is intended for use as described in the Instruction Manual. Do not use any attachments other than those recommended by the manufacturer.
- * **DO NOT** attempt to stand or sit on the backrest, armrest or footrest in order to prevent accident, injury or damage to the chair.
- * Avoid falling asleep while using the massage chair.
- * Always keep the massage chair clean, and never insert any objects into or around the gaps of the massage chair.
- * **DO NOT** move the massage chair by pulling on the power supply cord.
- * Make sure there are no children, pets or other obstacles behind or underneath the massage chair.
- * If you find any rips or tears in the fabric of the massage chair contact the service department.

-
- * This massage chair is designed for household use and should not be used in non-residential settings.
 - * Please consult your doctor if you are in doubt as to whether or not you should use this massage chair.
 - * Please consult a doctor before using the massage chair if you are pregnant, undergoing any medical treatment, using a medical electronic device such as a pacemaker, or are experiencing any of the following: Malignant tumor, heart disease, back pain, abnormal or curved back bone, osteoporosis or acute illness.
 - * If you experience pain while using the massage chair, stop using the chair immediately and consult your doctor.
 - * Never use a massage function on swollen or inflamed parts of the body.
 - * **DO NOT** use the massage chair for more than 30 minutes at a time.
 - * **DO NOT** use the massage chair where aerosol (spray) products are being used or where oxygen is being administered.
 - * This massage chair is a non-professional product designed to provide a comfortable massage and should not be substituted for appropriate medical treatment.
 - * Never operate the appliance with the air openings blocked. Keep the air openings free of lint, hair, and the like.

03 Chair components

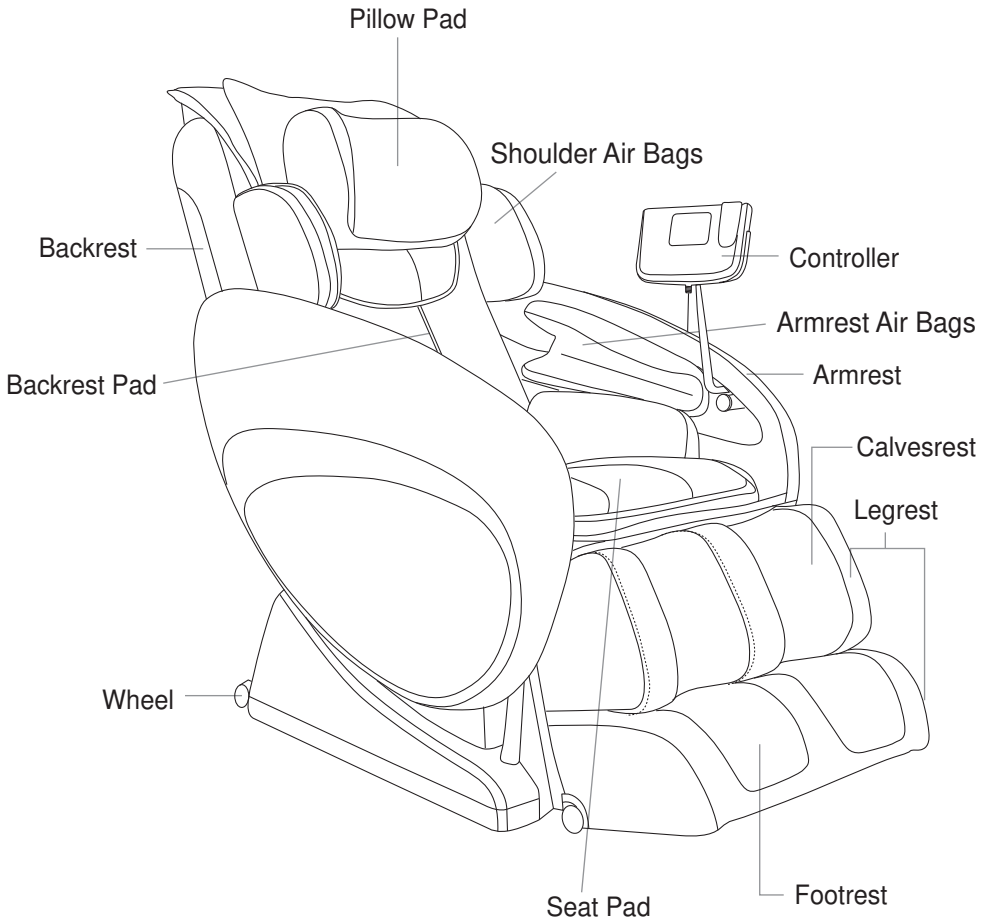

Massaging Position



04 Chair Installations



1. When positioning the chair, please leave 80cm of space behind the backrest to allow free reclining of the backrest.
2. Unplug from outlet when installing the Chair parts.

Step 1: Remove the following contents from two cartons:

- 1) The chair
- 2) The side boards

Step 2: Install the side boards.

- 1) Insert the side boards to the chair at 90 degrees.
- 2) Tighten the screws (4pcs, size: M6*55) securing the side boards.

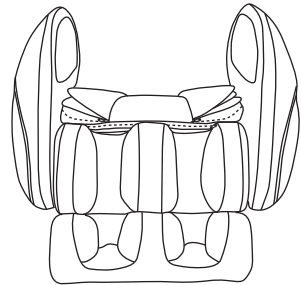
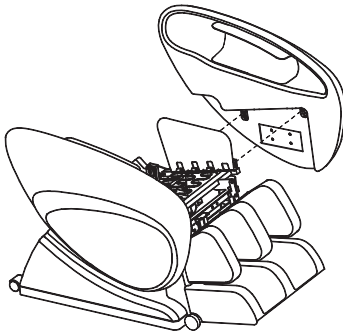

Step 3: Lift the backrest, then lower the backrest into the seat brackets, securely lock the flat head bolts into sides of the seat.

Note: Carefully unwrap the armrest to avoid scratching during installation.

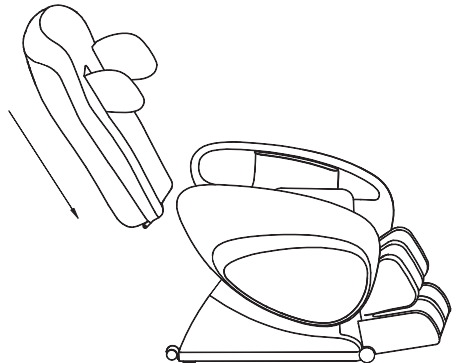

Step 4: Attach the connecting rod and the u stay fork of the reclining actuator with the flat head rivet, and secure with a split pin as demonstrated in PIC 1 and PIC 2.

- A. Connecting rod (on the backrest)
- B. U stay fork of reclining actuator (on the seat)
- C. Flat head rivet
- D. Split pin

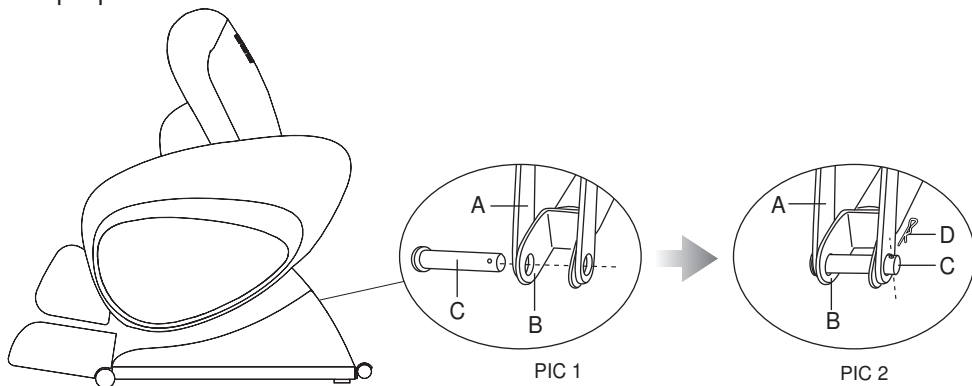

Step 5: Connect the plugs to the corresponding place in the seat according to the marks given.

Note: Insert black to black and gray to gray, otherwise damage to the chair may result.

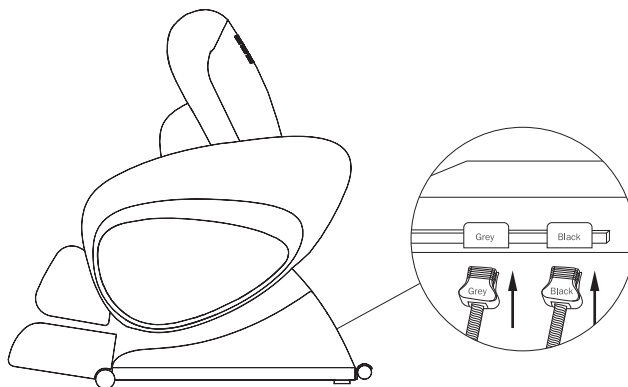

Step 6: Unfold the backrest until you hear it click into place.

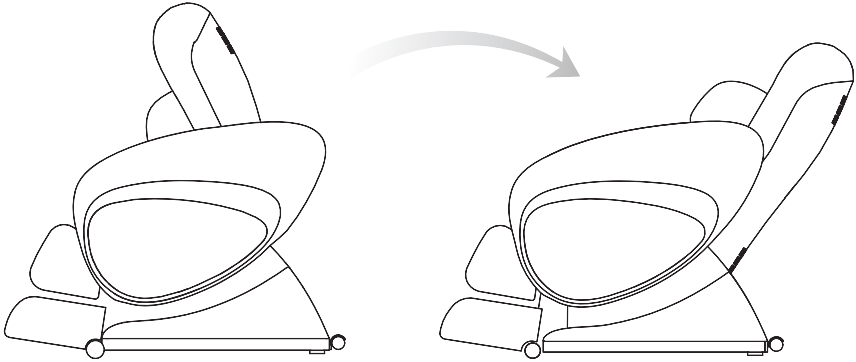

Step 7: Attach the backrest pad and the pillow pad.

A) Attach the backrest pad with the zipper.

B) Attach the pillow pad using the hook and loop fasteners.

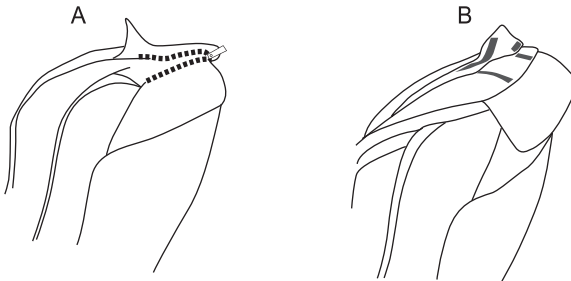

Step 8: Connect the wire plugs.

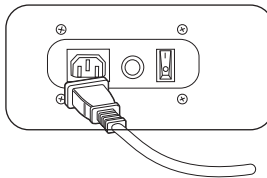

Step 9: Fix the remote controller to the holder by securing the screws.

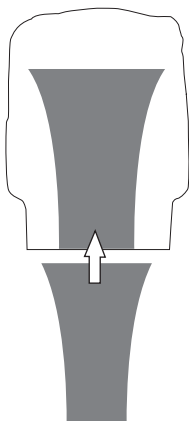
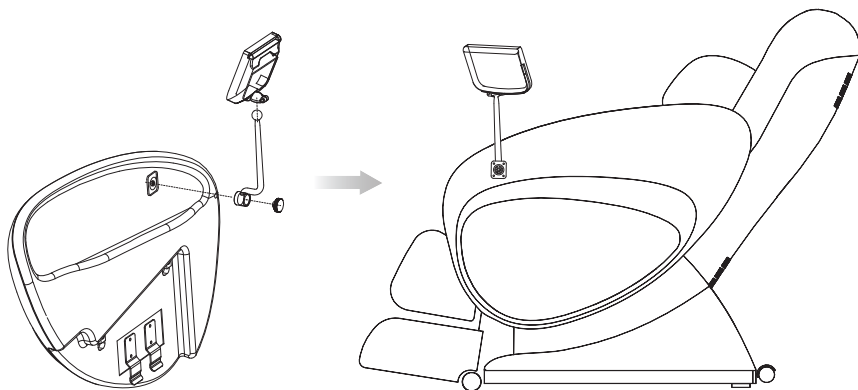

The back massage strength-control pad has been inserted into the backseat cover.

If strong massage is desired, remove the back massage strength-control pad from the cover; this strengthens the massage. If milder massage are desired, insert the back massage strength-control pad into the cover; this lessens the strength of the massage.

Moving the Chair

1. Lift up the Calves Rest.
2. Then recline the chair to approximately 45 degrees, so that you can easily move the chair around the house with a slight pull push.

Caution:

- 1) Before you move the chair, please put the footrest back into the original position first. Otherwise, injuries might occur in the process of moving.
- 2) Avoid moving the massage chair when there is someone seated on it.
- 3) Placing a mat underneath the massage chair is advisable, as the moving process might leave scratches on the floor surface.

Step 1



Step 2

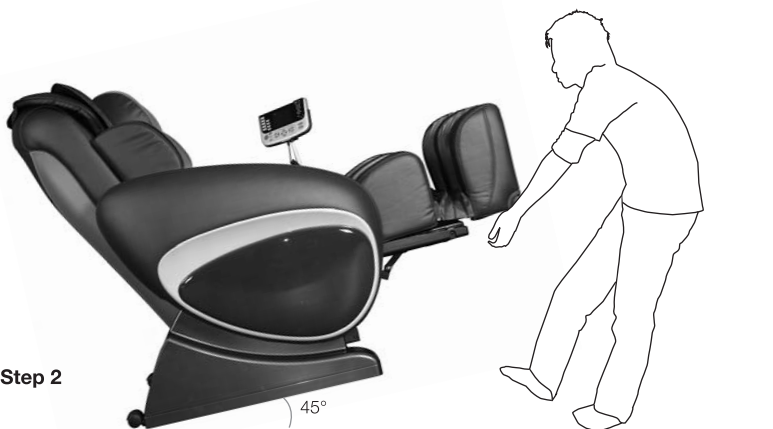

05 Grounding Instructions

Fully insert the plug into an appropriate outlet.

An improper equipment-grounding conductor may result in electric shock. Contact a qualified electrician if you are not sure that the product is properly grounded. Do not modify the plug that is included with the massage chair. If the plug does not fit the outlet, contact a qualified electrician to install an outlet to fit the massage chair plug.

06 Chair Specifications

Description	Specifications
Model No.	OS-4000
Rated Voltage	120V AC
Rated Frequency	60HZ
Rated Power Consumption	250W
Timer	5/10/15/25/30 minutes
Max Time Rate	60 minutes
Dimensions(LxWxH)	Product carton: 52.4" X 30.3" X 37.2"
	Side panel carton: 37.8" X 25.6" X 15"
Weight	Product gross weight: 284.4 lbs
	Product net weight: 244.8 lbs
Length of Wire	Controller wire: 1.3m
	Power supply wire: 2.2m
Usage Condition	Environment temperature: 10°-40°
	Contrasting humidity level: 30-85RH
Storage Condition	Storage temperature: 20°-60°
	Storage humidity level: 30-85RH
Safety feature	Equipped with overheated and power surge safety protection
Using benefits	Increasing blood circulation Relieving muscular fatigue

07 Controller Diagram

A. Full Body Auto Programme
 B. Localised Auto Programme

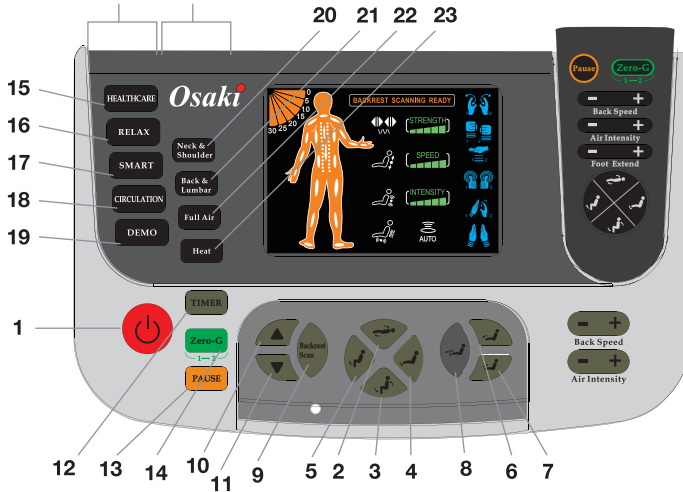

15
16
17
18
19
1
12
13
14
10
11
9
5
2
3
4
8
6
7



38
35
32
31
26
33
43
42
41
39
40
37
34
29
30
24
25
27
28

08 Operation Guide

Connect to the power supply, and turn the switch to “I” position. The chair is now in idle mode. During idle mode, there are only seven functions: ON/OFF, Foot Extend, Pause, Recline, Sit Up, Lift Leg or Recline Leg that can be operated.

CONTROL BUTTONS FOR THE MESSAGE CHAIR

1. ON/OFF

The Start/Stop Control Button

Press once on this button and the backlight of the Remote Control will start blinking: the chair is in idle mode. Press any massage function button to begin massage functions on the chair. This will also start the Timer.

Press this button again to stop all massage functions, the massage rollers will return to its original position.

2/3. Recline/Sit Up

Angle Adjustment Control Button for Massage Chair

These two control buttons can adjust the Reclining and Sit Up angle respectively.

Press once on the Reclining or Sit Up control button to adjust the Backrest and Footrest to a comfortable position. Press any of the control button again to adjust for Reclining, Sit Up, Lift Leg or Recline Leg, to confirm the position.

4/5. Lift Leg/Recline Leg

Angle Adjustment Control Button for Calves

These two control buttons can adjust massage angle on the Legrest.

Press once on the Lift Leg or Recline Leg control button, and the Legrest will adjust itself to a comfortable position. Press any of the control buttons again for Reclining, Sit Up, Lift Leg or Recline Leg to confirm the position.

Note: The adjustment angle functions will be activated by sustained pressing of the button for 2 seconds.

6/7. Length Adjustment Control Button for Legrest

These two control buttons can adjust the length on the legrest.

Press the button once to adjust the legrest to a comfortable length. Press the button again to confirm the length.

8. Length Auto Adjustment Control Button

It's equipped with an Auto Function that length of footrest can be adjusted according to the user's leg length for a more effective massage. Every time the button is pressed, the auto function will detect the best massage length.

9. Backrest Scan

Auto Scan Control Button

Press this button to activate the automatic scan that will position the massage rollers according to the user's height. When the massage rollers are positioned, a beep alerts the user that the manual backrest Up/Down adjustment buttons may be pressed within five seconds to further adjust the massage rollers.

Note: User should sit with shoulders flat against the back of chair for an accurate scan.

10/11. ▲/▼

Manual Backrest Up/Down Control Buttons

Press these buttons to manually adjust the massage rollers.

12. Timer

The Timer's Time Interval

After the massage process is activated, the chair will be automatically set on a 15-minute Timer. Subsequently, every time the "TIMER" button is pressed, the Timer's interval will be changed in the sequence of "20>25>30>5>10>15" minutes.

When there is only 1 minute remaining in the set time, the Backlight of the Remote Control will light up automatically, followed by 5 beeps to alert the user.

13. The Pause Button

When the chair is in massage mode and the user wants to temporarily pause it, press the Pause button and all massage functions will stop. The "Pause" icon will be blinking on the Liquid Crystal Display and the set time countdown will be paused as well. The chair is now in idle mode. Only the "Pause, Sit Up, Lift Leg, Recline Leg" can be used. Press the Pause button again to immediately cease the "Pause" function and resume the original massage function. The countdown continues.

14. Zero-G

Press this button to active the Zero-G function. Press the button again to stop the Zero-G massage function.

A. Full Body Auto Programme

If one of the five Auto Programmes is activated before the Auto Scan of the entire body, the machine will automatically do a height scan for the back. At the same time the user can manually adjust the massage height to the preferred level.

The following are the Auto Programmes available:

15. Healthcare

16. Relax

17. Smart

18. Circulation

19. Demo

Press this button for a brief demonstration of the features of the Massage Chair.

B. Localised Auto Programme

This programme gives precise massage at the exact part of the body for better localized-massage effect.

20. Neck/Shoulder

Neck/Shoulder Auto Programme Start/Stop Control Button.

21. Back/Lumbar

Back/Lumbar Auto Programme Start/Stop Control Button.

22. Full Air

Auto Air Squeeze Control Button

Press this button once to activate the seat, lumbar, back, shoulder, neck, calves and feet auto air squeeze function.

Press this button again to stop the auto air squeeze function.

Note: Press the Intensity button to adjust the intensity while the auto air squeeze function is activated.

Setting Lumbar Heating

23. Heat

Heating Function Start/Stop Control Button

Press this button once to activate the heating function for the lumbar.

Press this button again to stop the heating function.

24. Tapping

Tapping function Start/Stop Control Button- 3 sizes of width, 5 levels of speed to be adjusted.

Press this button once to active the tapping function for a full back massage at medium speed. Press the button again to stop the tapping massage function.

25. Clapping

Clapping function Start/Stop Control Button- 3 sizes of width, 5 levels of speed to be adjusted.

Press this button once to active the clapping function for a full back massage at medium speed. Press the button again to stop the clapping massage function.

26. Shiatsu

Shiatsu function Start/Stop Control Button- 3 sizes of width, 5 levels of speed to be adjusted.

Press this button once to active the shiatsu function for a full back massage at medium intensity. Press the button again, to stop the shiatsu massage function.

27. Rolling

Rolling function Start/Stop Control Button- 3 sizes of width.

Press this button once and it will activate the Rolling function for full back massage. Press again to stop the function.

This function cannot be used to perform “Spot” massage.

28. Swedish

Swedish function Start/Stop Control Button- 5 levels of speed to be adjusted.

Press this button once and it will activate the Swedish function for full back massage. Press again to stop the function.

29. Speed

The Speed Adjustment button for Tapping, Clapping, Swedish and Shiatsu mode.

After activating the Tapping, Clapping, Swedish or Shiatsu function, every time the button is pressed, the strength can be adjusted in the cycle.

30. Width

The Width Adjustment button for Tapping, Clapping, Shiatsu, Rolling mode.

After activating the Tapping, Clapping, Shiatsu or Rolling function, every time the button is pressed, the width can be adjusted in the cycle.

31. Kneading

Kneading function Start/Stop Control Button- 5 strength levels to be adjusted

Press once on "Kneading" to activate full back-massage of Kneading mode, press again to stop the Kneading function.

This function can be combined with Tapping/Clapping/Shiatsu to enjoy Kneading + Tapping, Kneading + Clapping, Kneading + Shiatsu multi massage functions.

32. Strength

The Adjustment Button for Kneading Speed

After activating the Kneading function, every time the button is pressed, the speed can be adjusted in the cycle.

Setting Spot or Localised Back Massage

33. Spot

The Spot or Localised Back massage

This button allows user to select Spot massage for any part on the back. Press this button once to activate spot massage while the original massage mode continues to run at the original position. Press again to cease Spot massage function and resume full back massage function.

34. Partial

The Partial Back Massage

This button allows user to select Partial Massage for any part of the back. The position for Partial Massage can be adjusted for a user friendly method of Localised Massage.

Press this button once to continue the original massage mode, while activating Partial Massage, which takes the original position as the centre to perform Partial Massage with the width of approx. 8cm. Press again to stop Partial Massage function and resume full back massage function.

35/36. Upward/Downward

Position Adjustment Buttons for Spot or Partial Massage

When the spot or partial massage functions are activated, these buttons will move the massage rollers.

Press and hold the Upward or Downward button to move the massage rollers up or down.

Release the Upward or Downward button when the desired position is achieved.

Setting Seat/Leg Vibration

37. Seat V

Seat Vibration function Start/Stop Control Button

Press the Vibration button once to activate the Vibration. Press this button again and it will stop the Vibration function.

Setting Air Massage

38. Neck

Neck Air Squeeze Start/Stop Control Button-5 levels of intensity

Press this button once to activate the neck air squeeze function.

Press the button again to stop the neck air squeeze function.

39. Shoulder

Shoulder Air Squeeze Start/Stop Control Button-5 levels of intensity

Press this button once to activate the shoulder air squeeze function.

Press the button again to stop the shoulder air squeeze function.

40. Back&Seat

Back and Seat Air Squeeze Start/Stop Control Button-5 levels of intensity

Press this button once to activate the back and seat air squeeze function.

Press the button again to stop the back and seat air squeeze function.

41. Arms

Arms Air Squeeze Start/Stop Control Button-5 levels of intensity

Press this button once to activate the arms air squeeze function.

Press the button again to stop the arms air squeeze function.

42. Calves

Calves Air Squeeze Start/Stop Control Button-5 levels of intensity

Press this button once to activate the calves air squeeze function.

Press the button again to stop the calves air squeeze function.

43. Intensity

Air Squeeze Intensity Adjustment Control Button-5 levels of intensity

Press this button to adjust the intensity of the air squeeze function while the air squeeze functions are activated.

Finish Operating

Please press the “ON/OFF” button after use, the chair will stop operation. Massage Rollers will resume to its original position; then switch the power supply button under the chair to “O” and unplug the machine from the socket.

09 Troubleshooting & Product Maintenance

This massage chair is controlled by a microcomputer and is susceptible to power surges of +10 to -15%.

The following situations may display in the event of a power surge:

Situation	Solution
The massage chair is connected to the power supply but is not functioning.	<ol style="list-style-type: none">1. Check to see that the plug is well connected and working.2. Make sure that the massage chair switch is turned to the "I" position.
The remote control works, but the massage chair is not functioning.	The massage chair may have overheated due to prolonged use. Turn off the power and allow the chair to cool for 30-50 minutes.
Both the remote control and the massage chair are not functioning.	<ol style="list-style-type: none">1. Make sure the chair is plugged into a working outlet.2. Turn the power OFF and then ON again.

10 Warnings

- * Do not use water and other cleaning detergents on the massage chair.
- * Do not stack, stab, slit or harshly pull on the surface of the massage chair.
- * Gently press the buttons during operation and avoid hitting the buttons with hard objects.
- * Pull out the power supply plug after each use.
- * Do not use the massage chair for more than 30 minutes at a time.
- * **DO NOT** position any body part in between the gaps of the leg rest when the automatic leg extension feature is in operation as demonstrated PIC 1, in order to prevent pinch to you. If you are remiss to position any body part in between the gaps of leg rest, please press ON/OFF button to stop and then get your body part out rapidly as demonstrated PIC 2.
- * If you have to rise from the chair to stop accident, injury or damage to others by you or you want to get your feet and calves out when the automatic leg extension feature is in operation, please press ON/OFF button to stop as demonstrated PIC 2, the footrest will gradually deflate in some seconds and then quickly get your foot and calves out and rise.

Note: This way as above mentioned just using in emergencies. Please bear in mind that always return the footrest to its original length and restore it to its original position, then rise from the chair in order to prevent accident, injury or damage to yourself and chair.

