



Jupiter Premium LE User's Manual

*Make your life healthy
and beautiful every day!*



Please read SAFETY INSTRUCTIONS carefully before using the chair.

Jupiter Premium LE

Function Introduction

1. The intelligent 3D technology will deliver a consistent soothing massage from your neck down to your hamstrings. Adopting traditional Oriental massage methods, you will come to experience a soothing kneading, pressing, tapping, and shiatsu-style massage that will invigorate the senses and relax the body.
2. With acupuncture point tracking innovation. It will deliver a massage that will massage the key areas while adjusting to different body types.
3. To enhance the massage experience the backrest is fitted with a warm soothing heating pad.
4. The Jupiter massage chair is equipped with a highly advanced L track system that reaches the neck down to the hamstrings.
5. With one simple touch of the remote, you can recline back into a comfortable zero gravity position that promotes an even distribution of weight throughout the back.
6. The forward sliding space saving technology is one of the great features that greatly eliminates the extra space required to recline. The backrest and seat frame glides forward as you recline the chair.
7. The foot massager has rounded points that lightly massage the bottom of the feet in combination with airbags that knead by applying a gentle squeeze.
8. In the calf region the airbags will deliver a pulsating action that will gently squeeze and release, refreshing the legs.
9. For the arms the same type of airbag massage is delivered. Simply slide your arms into the slots soon as you select the massage of your preference.
10. Multiple airbags are thoughtfully placed throughout the chair to provide a fully body massage experience.
11. The legrest and foot parts can be adjusted to any angle that you needed, It can extend and retract within the range up to 12.6 inches, to accommodate various heights.
12. The 7-inch touch-screen tablet is easy to operate, quick to respond, and and simultaneously displays the massage progress.

- ★ 1.Thank you for selecting the highly advanced Jupiter Premium LE massage chair by Titan.
 - 2.Please read this manual carefully before using the massage chair.
 - 3.Please keep this manual in a safe place for further reference.
 - 4.Please pay attention to SAFETY INSTRUCTIONS.
- ★ Note: We reserve the right for design modification. It is subject to change without notice. The pictures in this manual are only for reference. Please refer to the actual product.



Content

| | | |
|--------------------------|--|----|
| Preparation | Safety instructions ----- | 1 |
| | External structure parts ----- | 5 |
| | Internal structure parts ----- | 6 |
| | Mechanical components diagram ----- | 7 |
| | Mechanical components list ----- | 8 |
| Installation | Installation ----- | 9 |
| Massage Operation | Adjustment before Massage ----- | 13 |
| | Tablet remote control operation ----- | 15 |
| | Voice control instructions ----- | 23 |
| | Icon voice content ----- | 25 |
| | Operation instruction &function illustration ----- | 26 |
| | After massage ----- | 28 |
| Maintenance | Clean and maintenance ----- | 29 |
| Others | Malfunction guide ----- | 30 |
| | Technical data ----- | 31 |





Please keep this manual in a safe place for future reference.

- ★ Please read this manual carefully to make sure the installation and operation of the massage chair is correct.
- ★ “Safety Instructions” is provided in both Warning and Caution for important safety information.

Both Warning and Caution Signs are important, please pay close attention to these signs.

| | |
|--|--|
|  Warning | This sign indicates warnings of causes of possible injuries or deaths. |
|  Caution | This sign indicates caution to possible injuries or damages to things. . |



Symbol meaning

| | | | |
|---|---|---|--|
|  | This sign indicates forbidden behavior. |  | This sign indicates self disassembly is forbidden. |
|  | This sign indicates must follow instruction to operate. |  | This sign indicates correct operation of cable. |

- ★ The following should be kept for any further references.



Warning

| | | |
|---|--|--|
| | <ul style="list-style-type: none"> ● Those with Osteoporosis. ● People with heart disease including embedded pacemaker or other medical electronic device inside the body. ● For pregnant women or people not healthy, please consult doctor before use. ● Patients with a high fever forbid to use this machine. ● Perceptual disabilities patients forbid to use this machine. ● People over 80 years old forbid to use this machine. ● Kids and the drunk people are not allowed to use the chair. ● Please don't sleep in the chair. ● Don't use the chair when your body is wet. | People who are not suitable to use the chair |
|  | <ul style="list-style-type: none"> ● Make sure there are no kids or pets or other objects around (under, behind or in front of) the chair at the moment of backrest, leg-rest up/down or leg-rest retraction/extension from reclining position. ● During operation, If your body feels abnormal, please stop the operation and consult your physician before use. ● Please do not take strong massage on the head. ● Do not massage belly or knees, be careful when massage neck. ● Children or pets are not allowed to play on the chair especially during massage. Standing or sitting on the back or armrest is not allowed either. ● Those who are not sensitive to the heat or allergic to the heat must be careful when using it, or do not use. | Accident/Injury |
| | <ul style="list-style-type: none"> ● Insert the plug of the chair into correct and suitable power socket. Make sure the plug is completely inserted into the socket to reduce short circuit or fire risk. ● Unplug the power when not in use, stop all massage functions and turn off on/off key before unplugging. | Fire and electric shock |
|  | <ul style="list-style-type: none"> ● It is prohibited to use the massage chair while any items covered the massage chair ventilation holes. ● Massage cushions of the chair are not allowed to fold for storage. ● The machine is forbidden for no-load running for a long time. ● Power cord, plug, socket can't be used in broken or loose contact condition. ● Don't use other electric power except rated voltage in case of fire, electric shock or any breakdown. ● Any broken, re-process, knotted, twisted power cord or pressed under heavy cargo is not allowed to use. | Accident Fire and electric shock |
|  | <ul style="list-style-type: none"> ● If the chair is dysfunctional, or is broken, splashed with water or falls into water, please have it repaired by professional repairman or send the chair to assigned service agent. Self-modification, disassembly or maintenance is forbidden. ● If power cord or plug is damaged, please don't replace it yourself, please contact us or appointed dealer for replacement. ● To avoid electric shock or body injuries, please do not open or disassemble any part of the chair. ● Check leather or cloth material on the back and other areas is broken or not. If broken, even though it is small, please stop using the chair, unplug the power and have it repaired | Disassembly and maintenance |

**Caution**

| | | |
|--|--|--|
| | <ul style="list-style-type: none"> Please operate the chair in a flat or level place | To avoid sudden falling. |
| | <ul style="list-style-type: none"> Position the chair 10cm from the wall to allow for sufficient space to recline up and down. | To make sure the back lying. |
| | <ul style="list-style-type: none"> The maximum suggested operating time is 20mins. 5mins for each position beginning with the slight- step massage. Along continuous massage in the same position may cause uncomfortable feeling. | Too long time massage is bad for your body. |
| | <ul style="list-style-type: none"> Before sitting on the chair to avoid injury please inspect everything to confirm that the massage heads are in the correct position. | To avoid accidental injury. |
| | <ul style="list-style-type: none"> The tablet controller should be put on the holder in time, don't leave things in random places avoiding the tablet was squeezed or damaged by falling | |
| | <ul style="list-style-type: none"> Please make sure that the power switch is at the "OFF" position before inserting the plug into the socket. | To avoid the accident when turn on the power. |
| | <ul style="list-style-type: none"> Turn off all controls before removing plug from outlet. | |
| | <ul style="list-style-type: none"> Make sure the plug completely insert into the socket. | To reduce short circuits and any fire hazard. |
| <ul style="list-style-type: none"> Checking whether any damage on wire, make sure no water or rubbish on wire. | To avoid electric shock in any leakage or breakdown. | |
| <ul style="list-style-type: none"> Install earth wire the correct way. The plug must be inserted in the socket with the earth connect. The earth connection should not be bent or cut off.  | | |
| | <ul style="list-style-type: none"> Don't press with hands or step on the massage heads with feet. Don't put hands between the working massage heads. Don't put hands or feet in the gap of mechanical parts. Don't drop or embed anything into the slot of massage chair. Don't stand or sit or put anything on the backrest, armrest or leg-rest. Don't stand on the chair during operation. Don't move the chair during operation. Don't pull out the plug or turn off the power during operation. Don't put your hands or head between leg-rest or beneath. Don't use the massage chair while wearing hair ornaments. Don't put hard things in pocket when take buttocks and huckle massage. Don't sit or press on the backrest when the chair is in reclining position. Don't use at bare skin or were thin clothes, thin clothes may can achieve better massage effect, But it also may cause irritation to the skin or cryogenic burns. | To avoid accidents or injury |
| | <ul style="list-style-type: none"> Keep the chair away from heat, wet, sharp things and corrosive, inflammable, explosive environment. To use electric blanket or other heating products on the chair is forbidden. Don't put in the space of dust serious or corrosive gas environment, Don't put the chair in a small space places or use in the bad air circulation places. Keep the chair away from stove or other heating products. Don't put the chair directly under the sun or other high temperature places. | To avoid fade, discolor on upholstery or hardened, deteriorated on PU. |
| | <ul style="list-style-type: none"> Don't use the chair outdoor. | |

**Caution**

| | | |
|--|--|---|
| | <ul style="list-style-type: none"> Do not use or store the chair in any wet environment such as by the swimming pool, bathroom, and kitchen. Keep the chair and remote control dry all the time. | To avoid leakage or electric shock. |
| | <ul style="list-style-type: none"> Make sure to install the earth wire in correct way (Incorrect install way may cause electric shock. If you don't know how to install, please find a professional electrician) Don't use plug adapter (If the enclosed plug doesn't match with socket, please don't change the plug by yourself and find a professional electrician to install a matched socket.) | To avoid electric shock. |
| | <ul style="list-style-type: none"> Unplug the power before cleaning the chair. Unplug the power after using the chair. | To avoid electric shock or fire hazard. |
| | <ul style="list-style-type: none"> Unplug the power when any damage on the power. Hold the plug to unplug the power but not try to pull the wire to unplug the power. | |
| | <ul style="list-style-type: none"> Please turn off the power switch and unplug the power after massage. | To avoid accidents |
| | <ul style="list-style-type: none"> Unplug the power immediately when electricity goes off. | To avoid damage or accidents when power on again. |

Grounding instruction

- ✧ ※The chair is equipped with a cord having an grounding conductor. The plug must be plugged into an appropriate socket that is properly installed and matched with the plug.

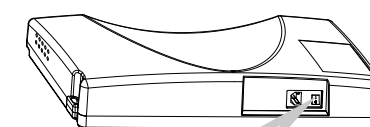
**Replace fuse**

- ✧ ※When the fuse is burned out, please turn off the switch and unplug the power. Open the lid covering the fuse which is located in the switch box. Use a fuse of the same size to replace the old one, then cover the lid properly. We recommend that you use an electrician to replace the fuse just in case.

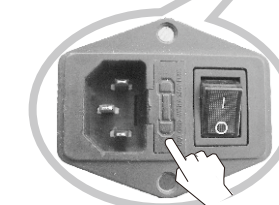

Earth wire is not allowed to be in these places

Gas pipe: May cause explosion or fire.
 Phone wire and lightning rod: May cause electric shock and fire when thundering.
 Water pipe: earth wire is useless where there are plastics

External structure



Preparation

Internal structure

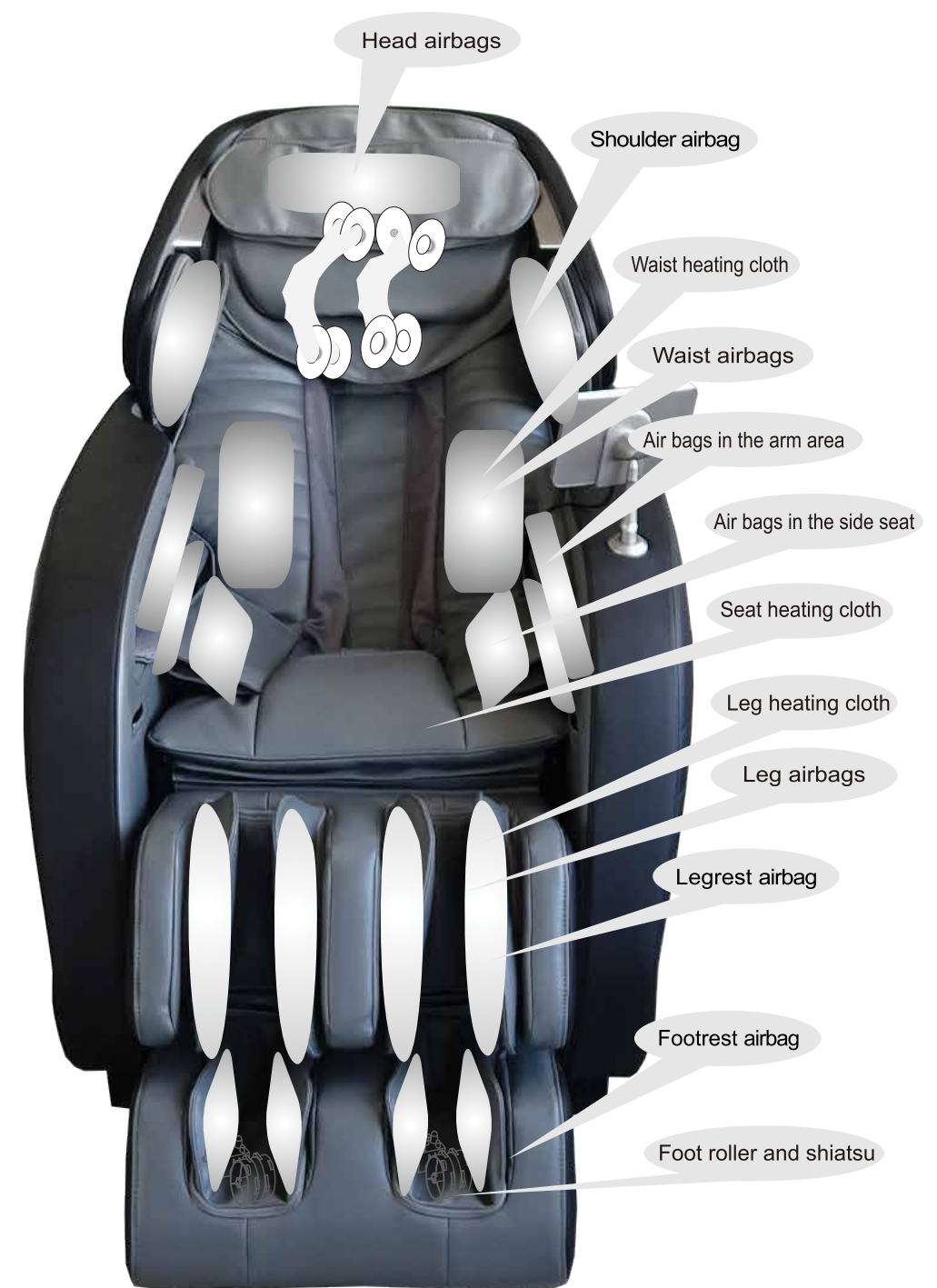

Preparation

Explosion Diagram

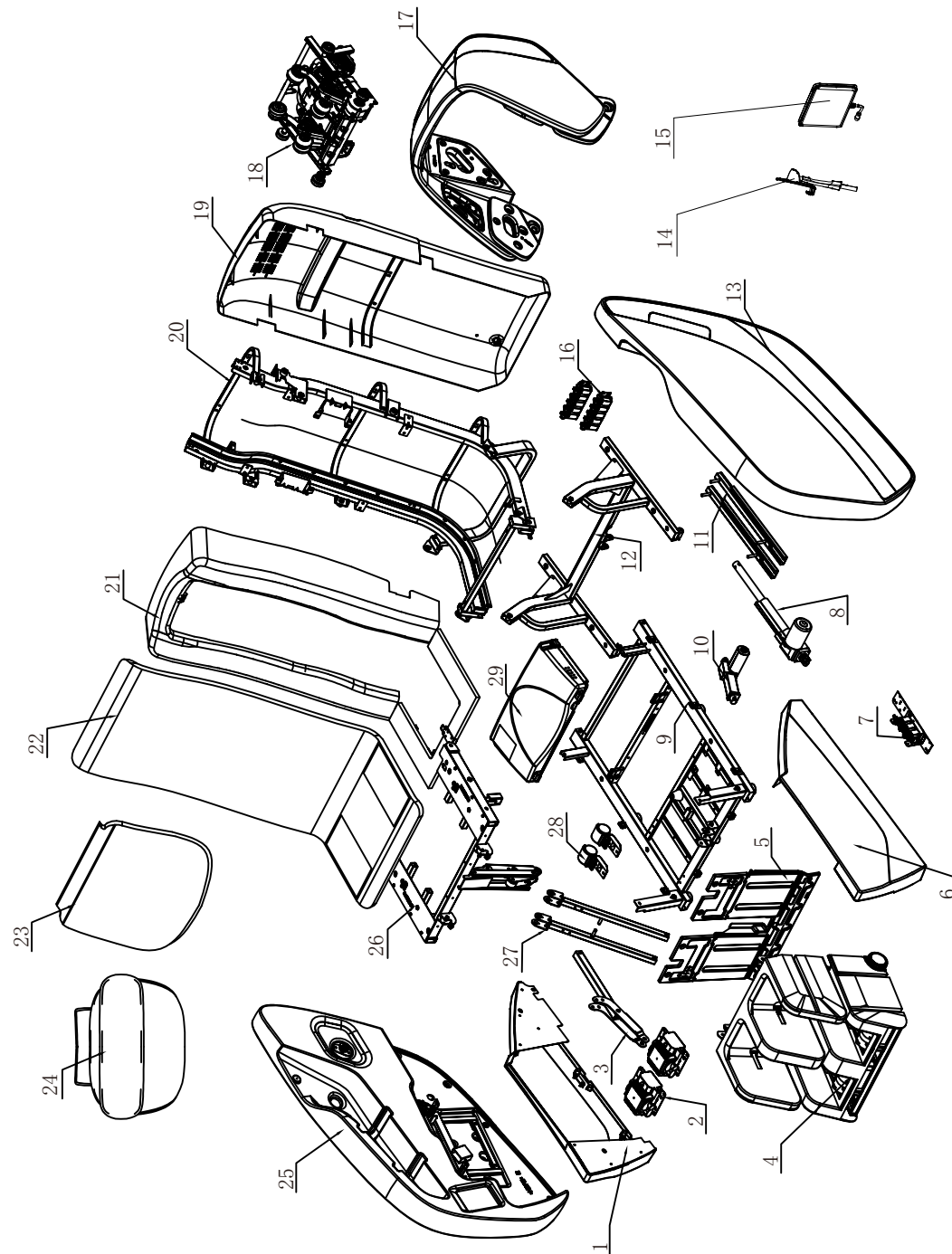

Preparation

Mechanical components list

| NO. | Name | Q' ty | NO. | Name | Q' ty |
|-----|--|-------|-----|-----------------------------|-------|
| 1 | Right side fender | 1 | 22 | Back and seat cushion | 1 |
| 2 | Air pump assembly | 2 | 23 | Shoulder pads | 1 |
| 3 | connecting rod | 1 | 24 | Pillow | 1 |
| 4 | Legrest & footrest | 1 | 25 | Right armrest assembly | 1 |
| 5 | Front fender | 1 | 26 | Seat frame surface assembly | 1 |
| 6 | Left side fender | 1 | 27 | Seat support bar | 1 |
| 7 | Electric magnetic valve | 1 | 28 | Castor | 2 |
| 8 | Backrest electric actuator | 1 | 29 | Power case assembly | 1 |
| 9 | Bottom seat frame assembly | 1 | | | |
| 10 | Footrest electric actuator | 1 | | | |
| 11 | Sliding rail | 2 | | | |
| 12 | Top seat frame assembly | 1 | | | |
| 13 | Left amrest assembly | 1 | | | |
| 14 | Tablet bracket | 1 | | | |
| 15 | Tablet remote control | 1 | | | |
| 16 | Electric magnetic valve | 2 | | | |
| 17 | Shoulder massage device | 1 | | | |
| 18 | Massage machine | 1 | | | |
| 19 | Back cover assembly | 1 | | | |
| 20 | Back frame assembly | 1 | | | |
| 21 | Backrest plastic front cover and seat plate assembly | 1 | | | |

Preparation

Installation (1)

Step 1. How to move the chair

- ① Take out the back seat cushion box from the main carton box at first , and then two more people grasp left and right metal frame ,take the chair body from the main carton box .
- ② Take pillow, back cushion, power line, controller, etc. from the back & seat cushion box. (as the picture shows)

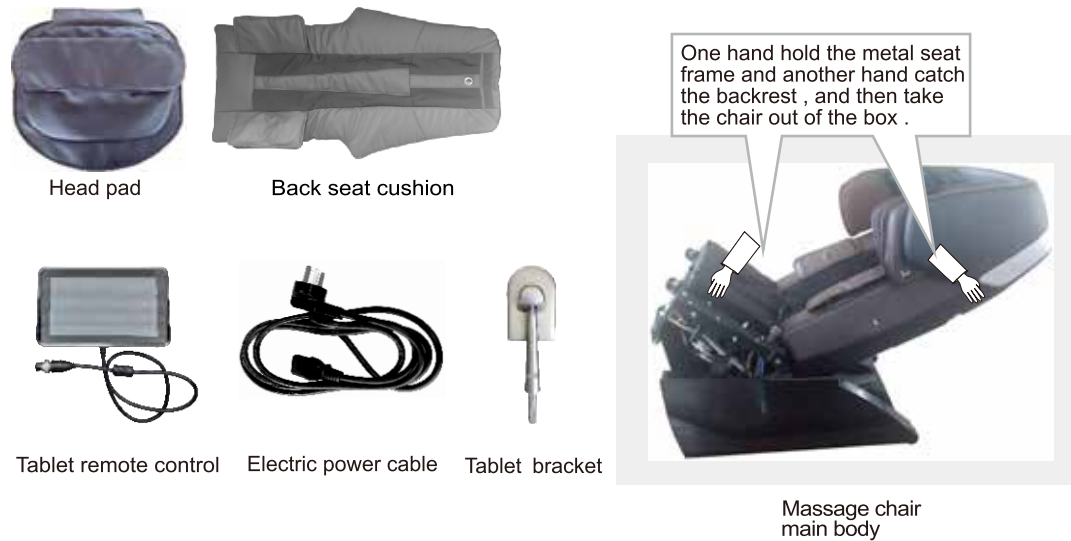

- ③ Slowly remove the left and right armrest from the armrest carton box. Lay the armrest on a completely flat surface (please be careful and pay close attention to prevent scratches). Gently position your hands in front and back of the armrest when installing the armrest.



- ④ Slowly remove the leg-rest from the leg-rest carton box. Gently position your hands in the front and backside of the leg-rest at all times (please be careful and pay close attention to prevent scratches).



Installation (2)

Step 2. Massage Chair Return Position

After removing the massage chair body from the box, 1) Take out the power cord, insert one end of the power cord to the socket on the power box, insert the other end to the power socket most likely located on the wall. 2) Turn on the power switch next to the power box of the massage chair, the massage chair will turn to a "Power on" status, the backrest will rise up, while the seat slightly goes down. 3) After the backrest returns, turn off the switch, unplug the power plug, (Refer to step 7 after assembly).

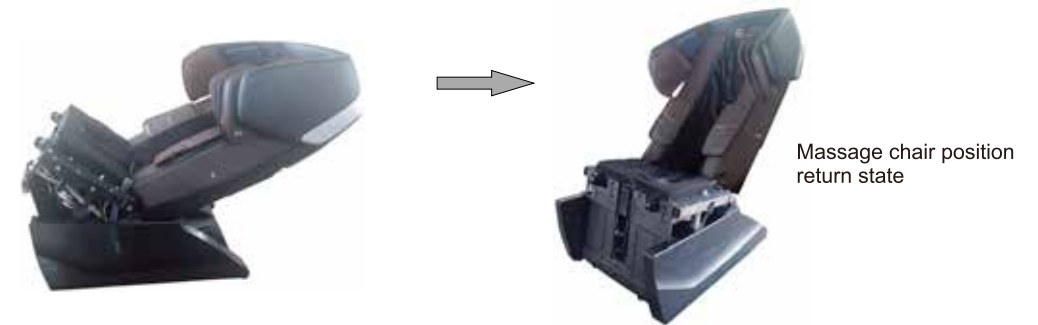

Step 3. How to Assembly (Leg Rest)

Install the leg-rest to the main body of the chair. 1) Unscrew the bolt from the hanger of the leg-rest. 2) Please insert three air tubes of the legs into the air taps of the main body, according to the color of the plug. From left to right, in turn, gray tube, brown tube, and black tube. 3) Connect the power line plug to the socket tightly. 4) Lift up the leg-rest, place the axis into the hanger of the main body, then place over/ put down the axis cover. 5) Screw the bolt tightly.



Installation (3)

- ① Use a Phillips screwdriver to remove the M6 screws on the iron frame of the seat surface and the upper end of the armrest;
 ② Insert the fixing hole on the inner rear end of the armrest, The fixed shaft on the side of the backrest; ③ Insert the square tube of the armrest into the side panel of the seat frame; ④ Properly move the armrests so that the front and back of the armrests are fixed. The fixed plate is aligned with the scr



Installation (4)



Back seat cushion

Head pad

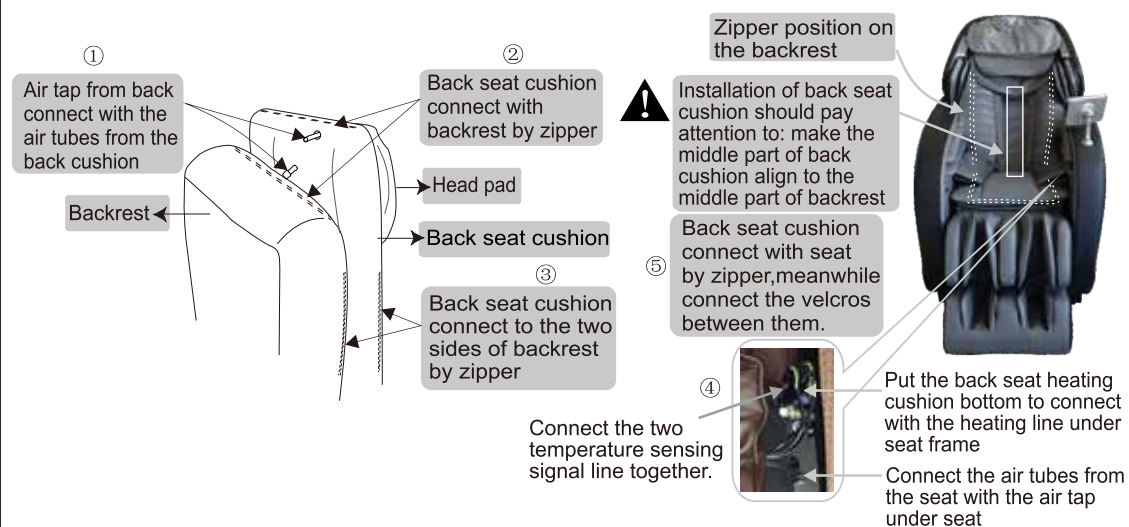

Step . After the Assembly

After the assembly, please operate the chair in this order:

- ① Plug the cable line in the hole a on the power box as shown in the right picture.
- ② Insert the plug of cable line into the socket.
- ③ Switch on. (Switch on/off "O/I", press I down to turn it on.)
- ④ Enjoy the massage by using the remote control.



Make sure the switch is off before you insert the plug of cable line into the socket.

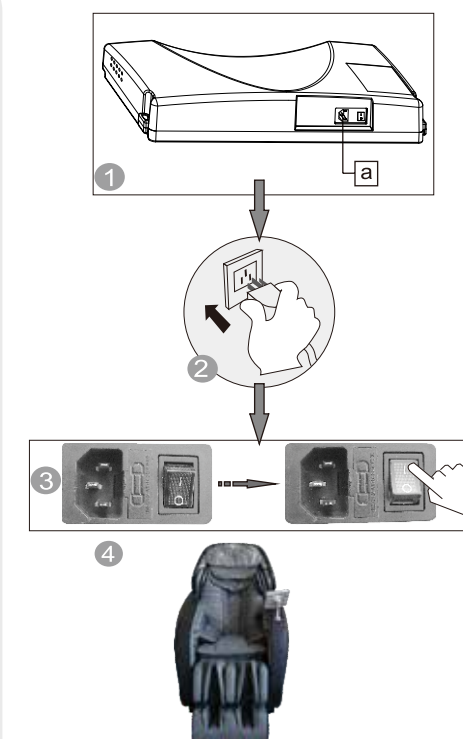

Environment

 **Caution**

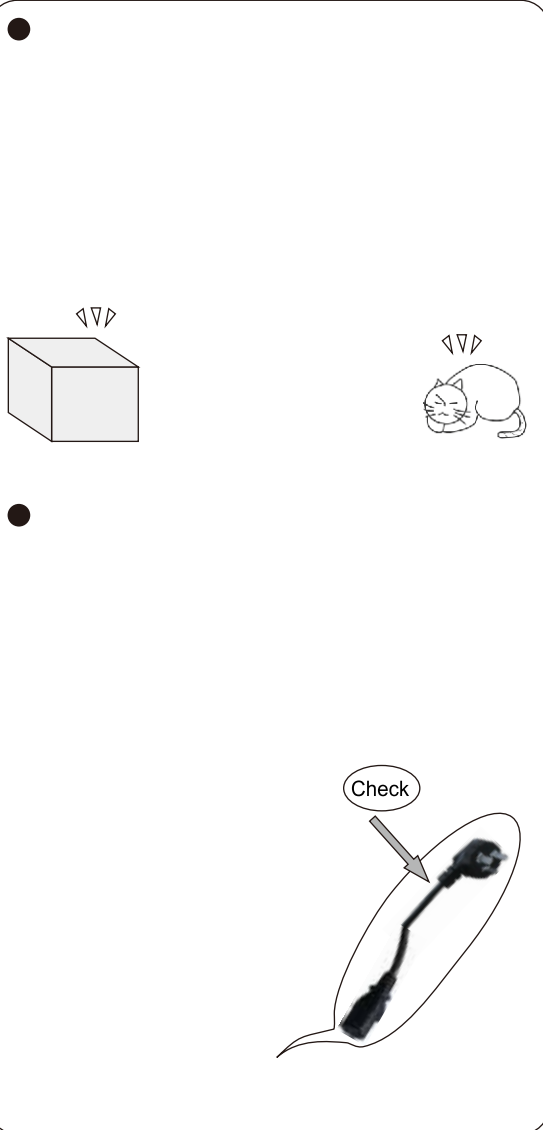

Check environment

● **Space size for using the chair**

- At least 10cm from wall.

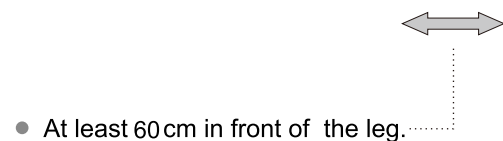
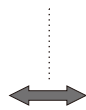

- At least 60cm in front of the leg.

● **Check surroundings**

When the backrest or legrest reclines or extends, please pay attention to:

- (1) Check any person or things in every direction.
- (2) Check the space size.

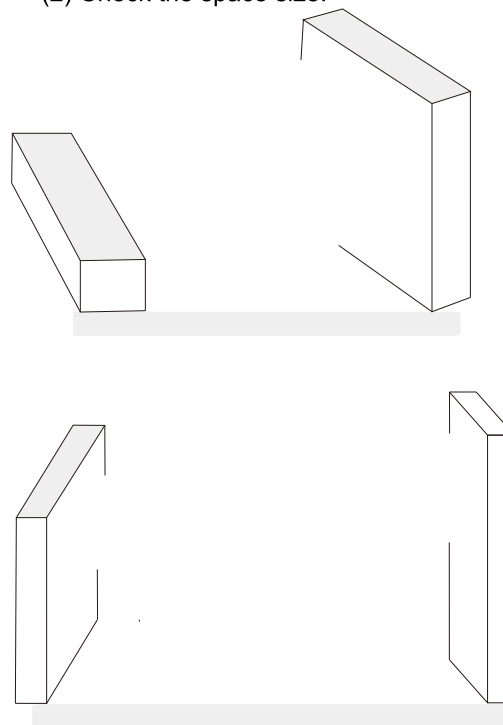

How to move massage chair

 **Caution**

- ✦ Don't move chair when it's working in case of accidents or damage

How to move

- ✦ Bind the cables and put them in the seat to avoid damage when moving.
- ✦ If you plump the chair, it may damage the inner parts of the chair .
- ✦ Don't use the castor if the floor is wooden or other easy damaged material. It will need 2 or more persons to lift the chair.

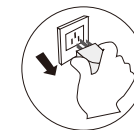

Normally

- 1 Lift up the legrest to make the gravity fall on the castor. Then push chair to destination and set it down.



Adjustment before massage



✦ **Acupuncture point tracking detecting**

When doing acupuncture point position detecting, if massage head can't detect the effective shoulder height position, the actual shoulder height position was default to the middle part of back.

Right position: Your back cling to the chair back, the head clings to the pillow.



● **Kind suggestion**

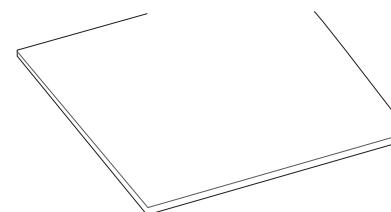

Tablet Remote Control Operation

Top Face of Tablet Remote Control

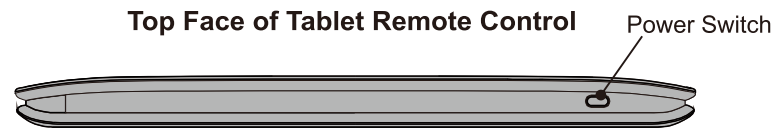

Tablet Remote Control

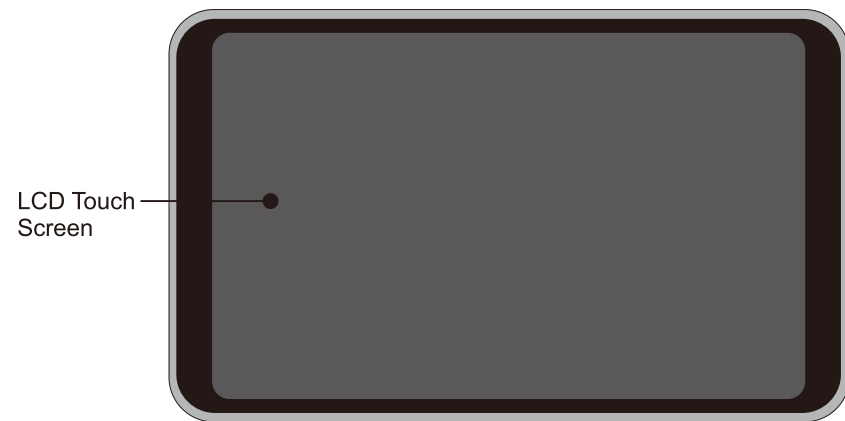

LCD Touch Screen

After the chair is powered on, the tablet is turned on by default and the boot interface is displayed. Wait for a while to enter the main interface. Press the power switch on the top right of the tablet controller to turn on/off the tablet controller.

Main Interface I

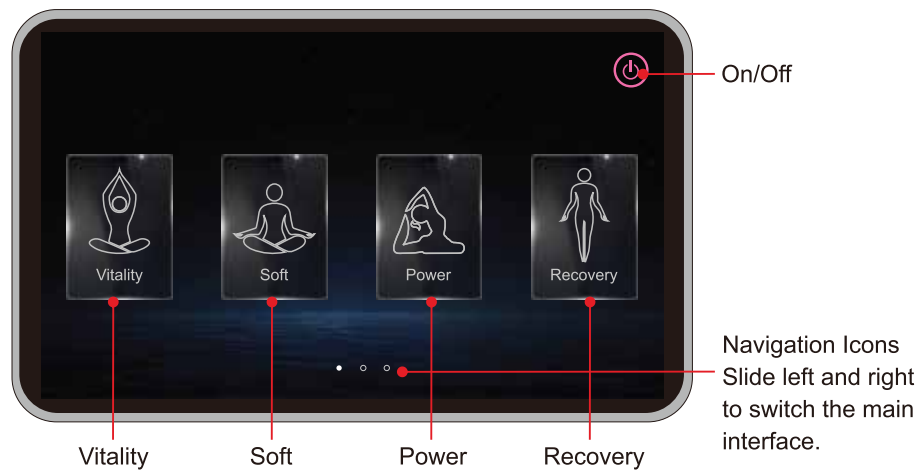

On/Off

Navigation Icons
Slide left and right to switch the main interface.

Vitality Soft Power Recovery

Massage operation

Tablet Remote Control Operation

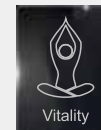

In the power-on state, click this button to brighten the icon and enter the "Vitality Massage" automatic program. The default working time is 8 minutes.

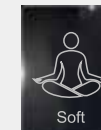

In the power-on state, click this button and the icon will light up and enter the "soft massage" automatic program. The default working time is 20 minutes.

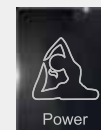

on the power-on state, click this button and the icon will light up and enter into the "power massage" automatic program. The default working time is 20 minutes.

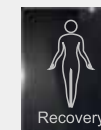

In the power-on state, click this button and the icon will light up and enter the "recovery" automatic program. The default working time is 20 minutes.

Main Interface I

Vitality, Soft, Power, Recovery interface



"Power on" button, click it to change to selected state, then you can use the function of massage chair.



"Pause" button, after clicking it, becomes "Continue button" and the massage chair pauses message, after clicking it becomes "Continue button", the massage chair resumes the message function. Note: After the pause, only the resume key and the shutdown key are valid.



"Return" Press this button, return to the home page.



"Knock" message method status display.



"Knead" message method display.



"Tap" message method status display.



"Shiatsu" message method display.



The heating default status is on, press to stop heating.



Message time left and adjust button, shows the time left for the current message function, Up and down arrow key can add or reduce the time.



Roller speed adjustment, has fast and slow two levels.



Air pressure adjustment button, a total of 5 gears, click "+" or "-" to adjust the intensity of the air pressure.



Position adjustment button, click and enter the position adjustment interface.



Body massage position, (screen can show the air massage, roller massage, heating status)

Massage operation

Tablet Remote Control Operation

Position Adjustment Interface



Zero gravity Zero gravity icon, click it to light to enter into the zero gravity function, the back will lie down, and the legrest will rise up.

Reset "Reset" button, click to light it up and the chair's backrest will rise up and the footrest will fall down.

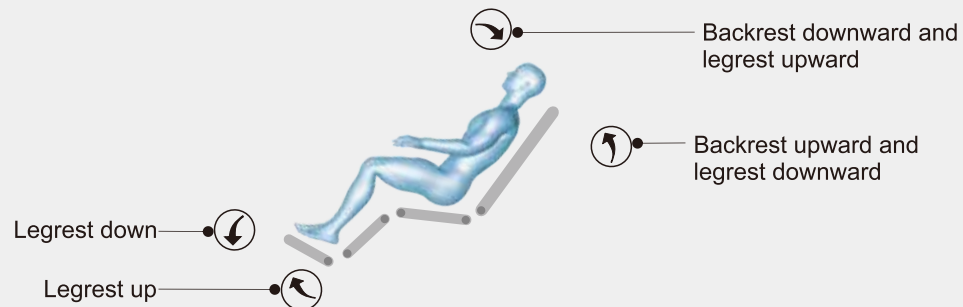

Massage operation

Tablet Remote Control Operation

Main interface II

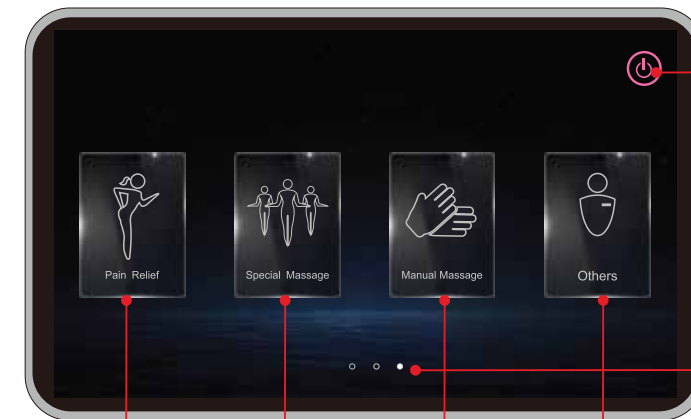

Pain Relief Special Massage Manual Massage Others

On/Off

Navigation icon, slide left and right to switch interface.

Pain Relief In the power-on state, press this icon enter pain relief mode, default working time for this auto program is 20 minutes.

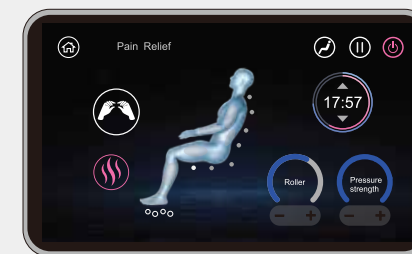

Pain Relief Interface

Special Massage In the ON status, press this key to enter Special Massage, 5 special auto programs for your option. (See Special interface introduction for details).

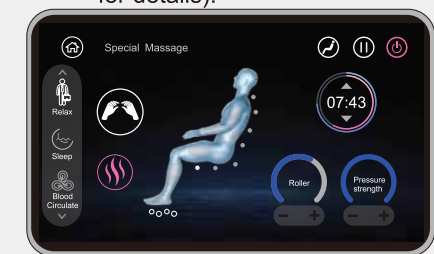

Special Massage Interface

Manual Massage In the ON status, press this key to enter Manual program interface. (See Manual interface introduction for details).

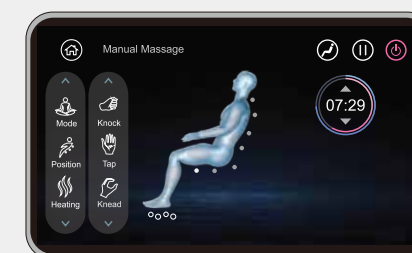

Manual Massage Interface

Others In the power-on state, click this button and the icon will light up and enter the "Settings" status interface.

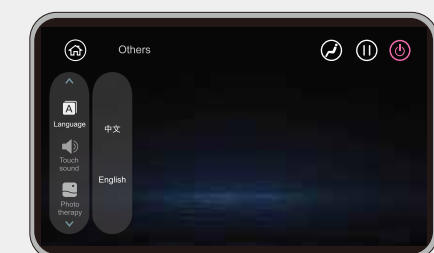

Others Interface

Massage operation

Tablet Remote Control Operation

Main interface II
Special Massage

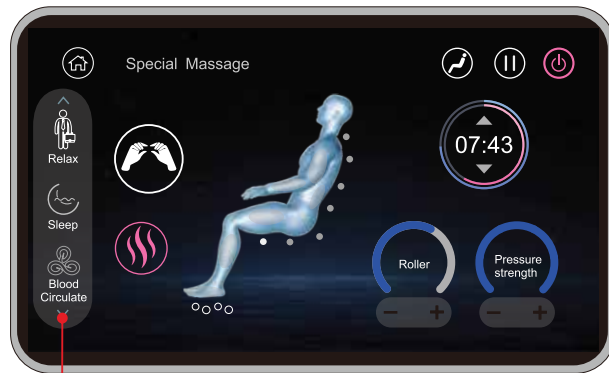

Special Massage Display Area

Waist massage
In the power-on state, press this icon and the icon will light up and enter Waist Massage mode, default working time for this auto program is 20 minutes.

Relax
In the power-on state, press this icon and the icon will light up and enter Relax mode, default working time for this auto program is 20 minutes.

Sleep
In the power-on state, press this icon and the icon will light up and enter Sleep mode, default working time for this auto program is 20 minutes.

Blood Circulate
In the power-on state, press this icon and the icon will light up and enter Blood Circulate mode, default working time for this auto program is 20 minutes.

Stretch
In the power-on state, press this icon and the icon will light up and enter Stretch mode, default working time for this auto program is 20 minutes.

Mode
In the Power-on state, after clicking this button, the icon lights up, one Mode menu will pop up and display Knocking, tapping, kneading, Shiatsu, knead&tap, Kneading&kneading six kinds of massage technique.

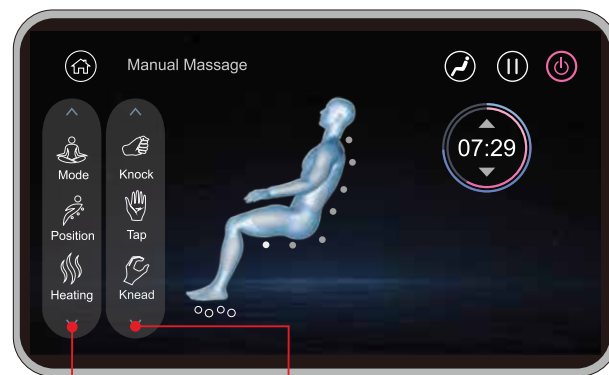

Manual Massage Mode Display Area
Display Area

Massage operation

Tablet Remote Control Operation

Main interface II
Manual Massage Interface

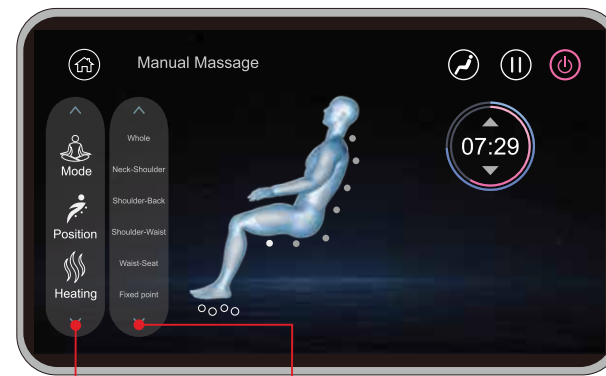

Manual Massage Mode Display Area
Display Area

Position
In the power-on state, click this button and the icon will light up and one menu will pop up, and display Whole, Neck-Shoulder, Shoulder-Back, Shoulder-Waist, Waist-Seat, Fixed point. Click Fixed Point and show Up-button and down-button, which can adjust the position.

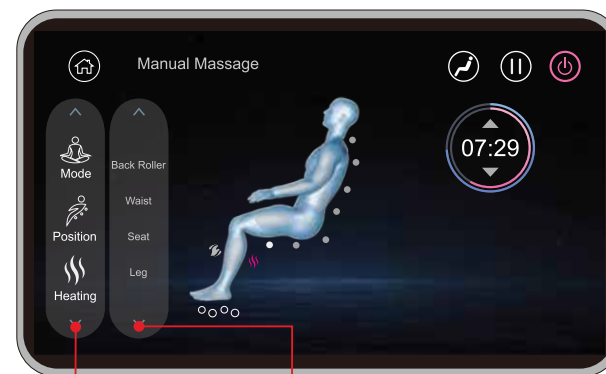

Manual Massage Mode Display Area
Display Area

Heating
In the power-on state, click this button and the icon will light up and enter heating menu and display Back Roller, Waist, Seat, Leg, click them to turn on or off heating.

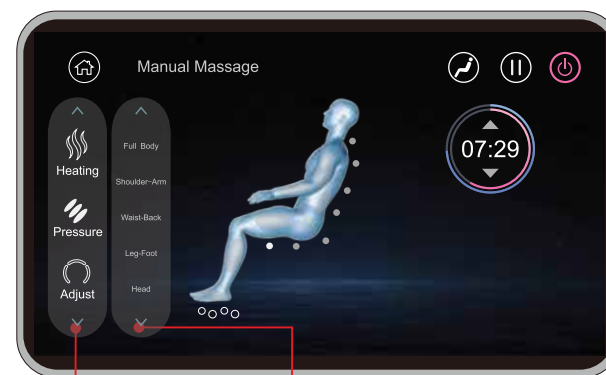

Manual Massage Mode Display Area
Display Area

Pressure
In the power-on state, click this button and the icon lights up and one menu will pop up, and display Full body, Shoulder-Arm, Waist-Back, Leg&Foot, Head, Shoulder-Foot, Arm-Seat, Waist-Foot, Upper Body, lower body. Click the button, the icon will light-up, and the pressure massage begins to work.

Massage operation

Tablet Remote Control Operation

Main interface II
Manual Massage Interface



Adjust
In the power on state , click this button and the icon lights up, and the adjustment button pops up, you can adjust the speed, 3D width, time , 3D strength, air pressure adjustment, roller speed. Click the "+" and "-" for adjusting the gear.

Manual Massage Display Area
Adjustment Display Area
Roller Speed Adjustment
3D Adjustment
Air Pressure Adjustment

Main Interface II
Set up interface

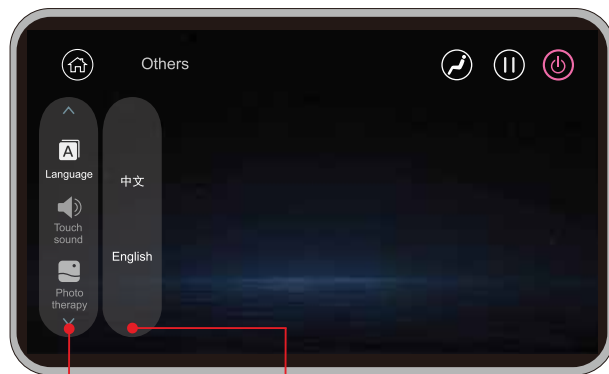

Language
In the power-on state, press this icon and the icon will light up and language button pops up , showing English and Chinese.

Set-up Display area
Mode Display Area

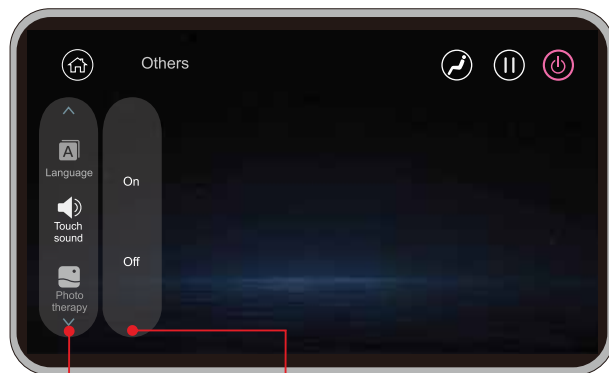

Touch sound
In the power on state , click this button and the icon lights up. Show "On" "off "menu, click the icon to turn on or off Touch sound.

Set-up Display area
Mode Display Area

Massage operation

Tablet Remote Control Operation

Main Interface II
Set up interface

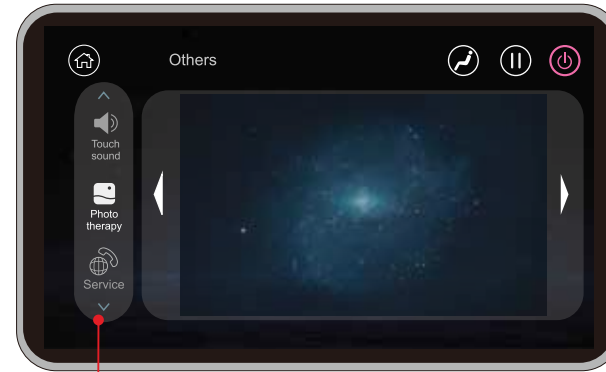
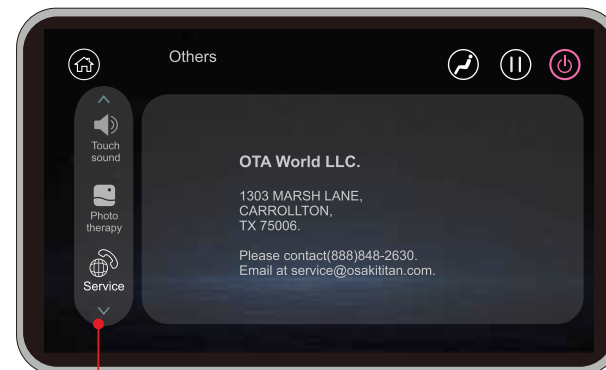

Photo therapy
In the power on state , click this button and the icon lights up. The background selection menu pops up. Swipe left and right to select the background. It will take effect after selection.

Set-up Display area



Service
In the ON status, click this icon to light up, show the company introduction, and service hotline, website etc.

Set-up Display area

Body scanning interface

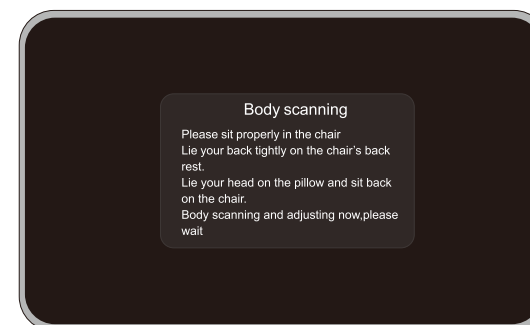

Body scanning finished, enter into manual shoulder height position adjustment interface.

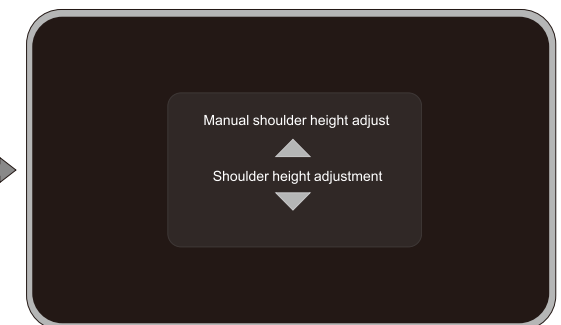

Massage operation

Voice control instructions

In the standby state, press the power switch of the tablet hand controller to enter the power-on state, and the voice recognition system enters the waiting state.



- When using the voice recognition function, you need to say the wake-up word "Hello, KIRI" before the system can recognize the subsequent voice commands. After the voice mode is turned on, if no voice command entry is spoken within 8 seconds, the system will automatically turn off the voice mode. After the massage chair recognizes the command, there will be corresponding speaker voice feedback, indicating that the command is successfully recognized. Please speak the following voice commands in English clearly and loudly. If it can not recognize your comment, please pause for 2 seconds and raise your volume to speak again.

- The entry of Voice command :

| The entry of Voice command | The feedback of Voice command |
|----------------------------|--|
| Hello,KIRI | Hi,I am here/Hi,what can I do for you? |
| Stop massage | Thank you,see you next time |
| Volume up | Volume up |
| | Already reached the limit |
| volume down | Volume down |
| | Already reached the limit |
| Power mode | Ok,Power mode on |
| Change a new mode | The technique is running for you |
| Recovery mode | Ok, Recovery mode on |
| Pain relief mode | Ok, Pain relief mode on |
| Stretch mode | Ok, Stretch mode on |
| Vitality mode | Ok, Vitality mode on |
| Burmese massage | Ok, Burmese massage on |
| Waist massage | Ok, Waist massage on |
| Blood circulate mode | Ok, Blood circulate mode on |
| Senior mode | Ok, Senior mode on |
| Sleepy mode | Ok, Sleepy mode on |
| A new technique | The Technique is running for you |
| Air pressure massage | Ok, Full body air massage on |
| Backrest Up | Ok, Backrest up |

Voice control instructions

| The entry of Voice command | The feedback of Voice command |
|----------------------------|-------------------------------|
| Backrest Down | Ok, Backrest down |
| Legrest Up | Ok, Legrest up |
| Legrest Down | Ok, Legrest down |
| Speed up | Ok, Speed up |
| | Already reached the limit |
| Slow down | Ok, Slow down |
| | Already reached the limit |
| 3D Plus | Ok, Already adjusted for you |
| | Already reached the limit |
| 3D Minus | Ok, Already adjusted for you |
| | Already reached the limit |
| Strong air | Ok, Strong air |
| | Already reached the limit |
| Weak air | Ok, Weak air |
| | Already reached the limit |
| Zero gravity | Ok, Zero gravity on |
| Position reset | Ok, Position reset |
| Foot rollers | Ok, Foot rollers on |
| Switch off foot rollers | Ok, Foot rollers off |
| Switch off voice function | Ok, Voice function off |
| Make it wider | Ok, Now is wider |
| | Already reached the limit |
| Make it narrower | Ok, Now is narrower |
| | Already reached the limit |
| Heat function | Ok, Heat function on |
| Switch off heat function | Ok, Heat function off |
| Pause massage | Ok, Massage pause |
| Continue massage | Ok, Massage continue |
| Function unavailable | |

Icon voice content

● Icon voice content

| |
|-----------------------------------|
| Hello, I am happy at your service |
| Dear,see you next time. |
| Emergency stop |
| Dear,see you next time. |
| Turn off |
| The mode is running for you |
| The technique is running for you |
| already adjusted |
| Width adjusted |
| Speed adjusted |
| Rollers up |
| Rollers down |
| Air intensity adjusted |
| legrest up |
| legrest down |
| backrest down |
| backrest Up |
| zero gravity on |
| position reset |
| already adjusted |
| massage pause |
| all heat on |
| all heat off |
| massage continue |

On/Off

Step1. Power on

- Put one end plug of the power line as shown in letter (A)
- Put power plug to socket.
- Turn on the power switch which is on the power box, massage chair is powered.

Step2. Massage

- Operate according to controller operation instruction.
- When the massage chair finishes massage, it will return to the default position, The tablet controller switches to the main interface.If no other operation ,the tablet controller will automatically turn off after 30 seconds.

Tablet remote control

Step3. Turn off the power

- When the chair is On, press On/Off button to turn off the massage chair and it will restore automatically.
- Turn off the power switch on the bottom of the back of chair after the rollers stay at storage position.
- Unplug the power plug from the socket.

Warning

- Before using, pull up the pillow, back cushion etc. to check if the PU material is broken, if there is damage, please stop using, unplug the chair, and ask for repairment.
- Only plug to proper socket.

Attention

- Before sitting down, make sure there is no things pinched between armrest, legrest , backrest and seat of the chair.
- Make sure the chair is in returned position before using.
- Do not stand on it when using the massage chair.

Function Illustration

● Legrest up and backrest down

Press this button on controller, backrest go down and legrest go up. Release this button, backrest and legrest stop moving, the angle is locked in this position.



● Legrest extend and retract

Legrest can extend or retract within a range of 32CM.



● Backrest up and Legrest down

Press this button on controller, backrest go up and legrest go down. Release this button, backrest and legrest stop moving, the angle is locked in this position.



● Arm massage

Put arms between arm airbags before the embedded airbags filled with air. It will perform pinch massage techniques to arms and hands after airbags inflating.



● Legrest Down

Press this button on controller, legrest goes down. Release the button, legrest stops moving, the angle is locked in this position.



● Shoulder massage

Multilayer extrusion airbags is deployed on both sides of the shoulder. Achieve pressure shoulder stretch massage, relieve shoulder fatigue.



● Legrest Up

Press this button on controller, legrest goes up. Release the button, legrest stops moving, the angle is locked in this position.



● Zero gravity

Press the button "Zero", backrest go down and legrest raise up, the chair go into Zero gravity status automatically. Press the Button again, the backrest and legrest stop moving, and it will lock at this position. However to change the angles, we can keep comfortable massage status all the time.

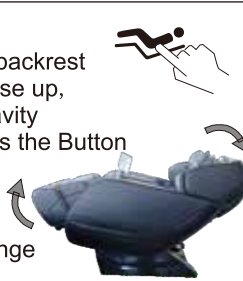

● Foot roller massage

Footrest parts with roller massage and air pressure massage function. Through stimulating the foot reflex zones, and clear the body meridians, regulate and restore human organs function, improve the body resistance and immunity effectively.



- ! 1. Please make sure there is no people, no pets or any stuff within range for backrest to avoid unexpected hurt or property loss.
2. When adjusting the backrest, be careful the gap between the backrest and armrest.
3. When the legrest is moving, please do not stand on or leave from the seat, do not stop the legrest from moving in case of causing damage to the chair.
4. Please refer to control instruction for more details.

Restoration of massage chair

- 1 Make sure there is no people or pet or anything within the range of backrest and legrest.



- 2 Make backrest and legrest restore to the normal position by controller. (or press ON/Off key to make backrest and legrest restore to the normal position)

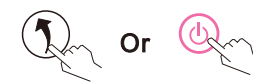

- 3 After the chair restores, put the tablet into the holder.



- 4 Put the pillow pad on to the right position.

- 5 Switch off the power.

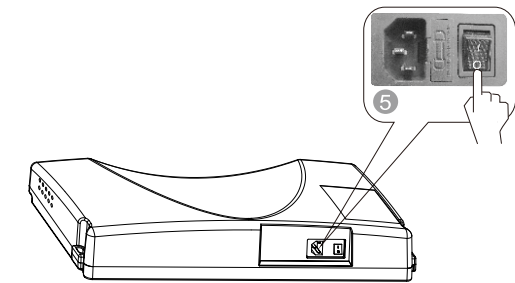

- 6 Unplug the electricity from the socket. (Attention: hold the right plug position)

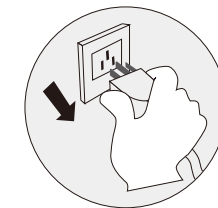

- 7 Clean the chair if necessary.



Attention!

- After using, press ON/OFF to end all the massage method and wait for restoration.
- Make sure to cut the electricity to avoid any unexpected hurt to children or pets.
- After using, turn off the power, unplug the electricity. Avoid moisture, dirt and aging of insulation in case of causing damage.

Synthetic leather

● **General cleaning**

Clean with tidy, soft and dry cloth slightly.



(Chemical or medical cleaning products are forbidden)



● **If leather is dirty**

- ① Dip soft cloth into 3-5% neutral detergent solution, squeeze it then clean the stain on the surface gently.
- ② Wash cloth, squeeze it and wipe with detergent.



- ③ Clean it softly with dry cloth.
- ④ Allow to dry (air blower is prohibited)

Plastic parts

- ① Dip cloth into neutral detergent, squeeze it and clean.
- ② Wipe with water-dipped but squeezed cloth.
- ③ Allow to dry.



Clean the controller

- ① Wipe with soft cloth after squeezing.
- ② Allow to dry.
Propellant, diluent or alcohol are prohibited.



Cloth material

- ① Dip cloth into weak neutral detergent, squeeze it and clean the material surface.

- (Diluent, gas, alcohol are prohibited)
Brush the dirty parts with weak neutral detergent. (avoid excessive brushing)

- ② Excessive cleaning may cause damage to cloth material.
- ③ Wipe with water-dipped but squeezed cloth.
- ④ Allow to dry.



About cleaning

- Before cleaning, unplug the electricity, don't touch plug with wet hands.
- Make sure hands are dry when plugging to the socket.
- If failed to follow the mentioned instruction, user may get electric shock or burned.

Maintenance

Others

FAQ and Troubleshooting

| Trouble | Possible reason | Troubleshooting |
|--|--|--|
| The massage chair can't work after power is on. | Check if the control is on or not. | Open control switch |
| | Not choose massage function | Choose massage function |
| | Check whether the plug and socket in poor contact. | Make sure plug and socket are connected. |
| | Wire or plug has damaged. | Please ask manufacturer or appointed or authorized maintenance man for checking and replacement. |
| | The fuse burned out. | Replace fuse of same specification. |
| There is beep sound inside the massager while working. | It is sound of air pump, motor and mechanical parts. | Normal sound, no need to pay attention to it. |
| | | Different height of the left roller and right roller. |
| Sound suddenly becomes much louder while working. | Check if it is due to long time working. | Turn off the power to have the massager rest for over half an hour before next turn working. |
| | Inner parts fretted away due to long time work. It's normal | Please ask appointed or authorized maintenance man for checking and repairing. |
| Massage function suddenly stops while working. | Suddenly power-down | Connect the electricity power again |
| | Setting time is up. | Restart |
| Neither the backrest nor the legrest can be lay down. | Check if there are any obstacles; the chair overloads; for the sake of safety, sometimes the massage machine may automatically stop working. | Remove the obstacles; turn off the power to have the massager rest for over half an hour before next turn working. |
| The chair can't return to its original position. | Excessive operation; setting time is up. | Please ask manufacturer or appointed or authorized maintenance man for checking and replacement. |
| Electric wire or plug give out heat | It may work overload | Turn off the power to have the massager rest for over half an hour before next round working. |
| | Other abnormal case | Stop using, and ask appointed maintenance man for help. |



Note: If the troubles are not caused by above reasons, please turn off the power switch and cut off the power, then contact the manufacturer or service agent to repair your chair.

Technical data

| | | | |
|---------------|---------------------|-------|---|
| Name | TITAN massage chair | Power | 200 W |
| Model | Jupiter Premium LE | NW/GW | Mainbody: 171.60/224.40 lbs Armrest: 34.1/48.40 lbs Legrest & footrest: 33/38.5 lbs |
| Input voltage | 120V~ 60Hz | | Packing size |
| Safety design | Class I | | |