

Osaki
P L A T I N U M

Osaki
P L A T I N U M

USER MANUAL

OP-4D SOLIS

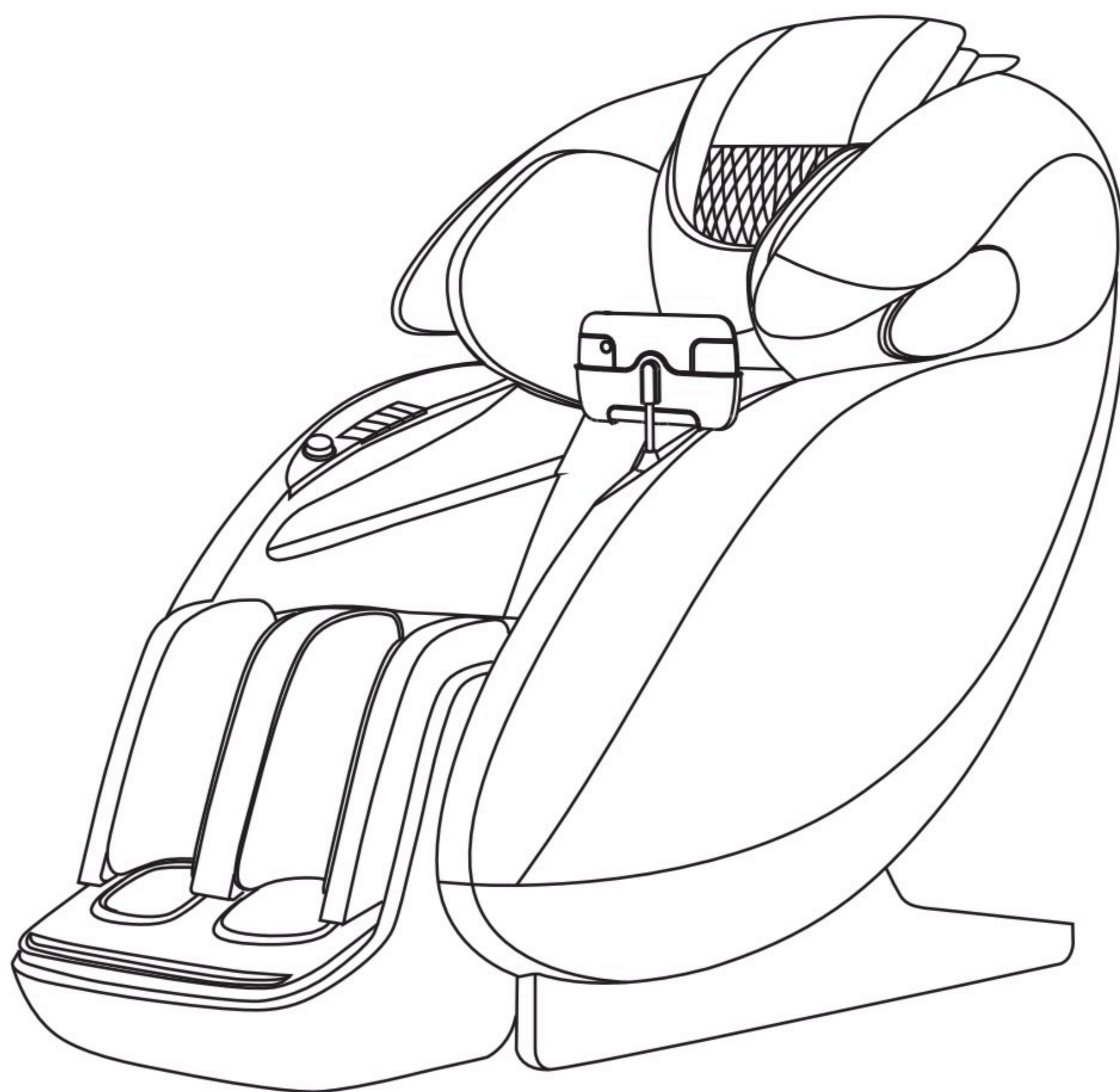

Contents

Important Safety Instructions.....	1–3
Product Specifications	4
Product Description	5–7
Preparation For Use.....	8
Installation Instructions.....	9–12
Control Panel	13–20
Troubleshooting	21
Care & Maintenance	22

IMPORTANT SAFETY INSTRUCTIONS

When using an electrical appliance, basic precautions should always be followed, including the following:

Read all instructions before using Massage chair.

DANGER – To reduce the risk of electric shock:

- 1) Always unplug this appliance from the electrical outlet immediately after using and before cleaning.
- 2) Never use pins or other metallic fasteners with this appliance.
- 3) Carefully examine the covering before each use. Discard the appliance if the covering shows any sign of deterioration, such as checking, blistering, or cracking.
- 4) Keep Dry – Do not operate in a wet or moist condition.

WARNING – To reduce the risk of burns, fire, electric shock, or injury to persons:

- 1) An appliance should never be left unattended when plugged in. Unplug from outlet when not in use, and before putting on or taking off parts.
- 2) Do not operate under blanket or pillow. Excessive heating can occur and cause fire, electric shock, or injury to persons.
- 3) Close supervision is necessary when this appliance is used by, on, or near children, invalids, or disabled persons.
- 4) Use this appliance only for its intended use as described in this manual. Do not use attachments not recommended by the manufacturer.
- 5) Never operate this appliance if it has a damaged cord or plug, if it is not working properly, if it has been dropped or damaged, or dropped into water. Return the appliance to a service center for examination and repair.
- 6) Do not carry this appliance by supply cord or use cord as a handle.
- 7) Keep the cord away from heated surfaces.
- 8) Never operate the appliance with the air openings blocked. Keep the air openings free of lint, hair, and the like.
- 9) Never drop or insert any object into any opening.
- 10) Do not use outdoors.
- 11) Do not operate where aerosol (spray) products are being used or where oxygen is being administered.
- 12) To disconnect, turn all controls to the off position, then remove plug from outlet.

IMPORTANT SAFETY INSTRUCTIONS

13) Temperatures sufficiently high to cause burns may occur regardless of the control setting. Do not use on an infant or invalid or on a sleeping or unconscious person.

Do not use on insensitive skin or on a person with poor blood circulation. Check the skin in contact with the heated area of the appliance frequently to reduce the risk of blistering.

14) Do Not Crush – Avoid sharp folds.

15) Keep children away from extended foot support (or other similar parts).

16) Connect this appliance to a properly grounded outlet only. See Grounding Instructions.

17) Do not use massager in close proximity to loose clothing or jewelry.

18) Keep long hair away from massager while in use.

SAVE THESE INSTRUCTIONS

GROUNDING INSTRUCTIONS

This product must be grounded. If it should malfunction or breakdown, grounding provides a path of least resistance for electric current to reduce the risk of electric shock. This product is equipped with a cord having an equipment-grounding conductor and a grounding plug.

The plug must be plugged into an appropriate outlet that is properly installed and grounded in accordance with all local codes and ordinances.

DANGER – Improper connection of the equipment-grounding conductor can result in a risk of electric shock. Check with a qualified electrician or serviceman if you are in doubt as to whether the product is properly grounded. Do not modify the plug provided with the product – if it will not fit the outlet, have a proper outlet installed by a qualified electrician.

This product is for use on a nominal 120-V circuit and has a grounding plug that looks like the plug illustrated in sketch A in Figure 1. Make sure that the product is connected to an outlet having the same configuration as the plug. No adapter should be used with this product.

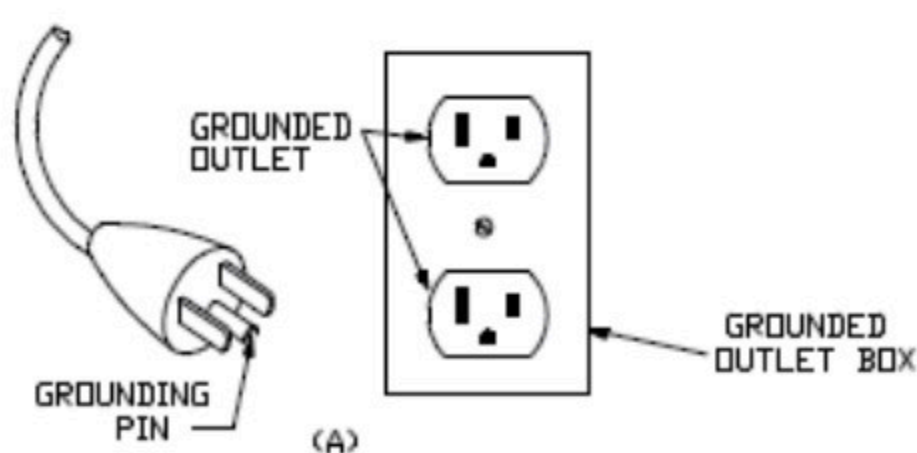

IMPORTANT SAFETY INSTRUCTIONS

RF exposure statement

This equipment complies with the FCC radiation exposure limits set forth for an uncontrolled environment. This transmitter must not be co-located or operating in conjunction with any other antenna or transmitter.

FCC Warning

This device complies with Part 15 of the FCC Rules. Operation is subject to the following two conditions:

(1) This device may not cause harmful interference, and (2) this device must accept any interference received, including interference that may cause undesired operation.

NOTE 1: This equipment has been tested and found to comply with the limits for a Class B digital device, pursuant to part 15 of the FCC Rules. These limits are designed to provide reasonable protection against harmful interference in a residential installation. This equipment generates uses and can radiate radio frequency energy and, if not installed and used in accordance with the instructions, may cause harmful interference to radio communications. However, there is no guarantee that interference will not occur in a particular installation. If this equipment does cause harmful interference to radio or television reception, which can be determined by turning the equipment off and on, the user is encouraged to try to correct the interference by one or more of the following measures:

- Reorient or relocate the receiving antenna.
- Increase the separation between the equipment and receiver.
- Connect the equipment into an outlet on a circuit different from that to which the receiver is connected.
- Consult the dealer or an experienced radio/TV technician for help.

NOTE 2: Any changes or modifications to this unit not expressly approved by the party responsible for compliance could void the user's authority to operate the equipment.

Bluetooth link

Turn on Bluetooth of mobile phone, click search, find Bluetooth name is Bluetooth name :MusicStation_xxx.

Product Specifications

Product Name	Massage Chair
Model	OP-4D SOLIS
Power Input	110-120V~, 60Hz
Auto Timer	15 mins
Power Consumption	200W
Product Weight	Approx.259.5lbs
Unit	1Box
Product Dimension	63(L) x 30.3(W) x 47.2(H)inches
Maximum Body Weight of User	352lbs

Side View

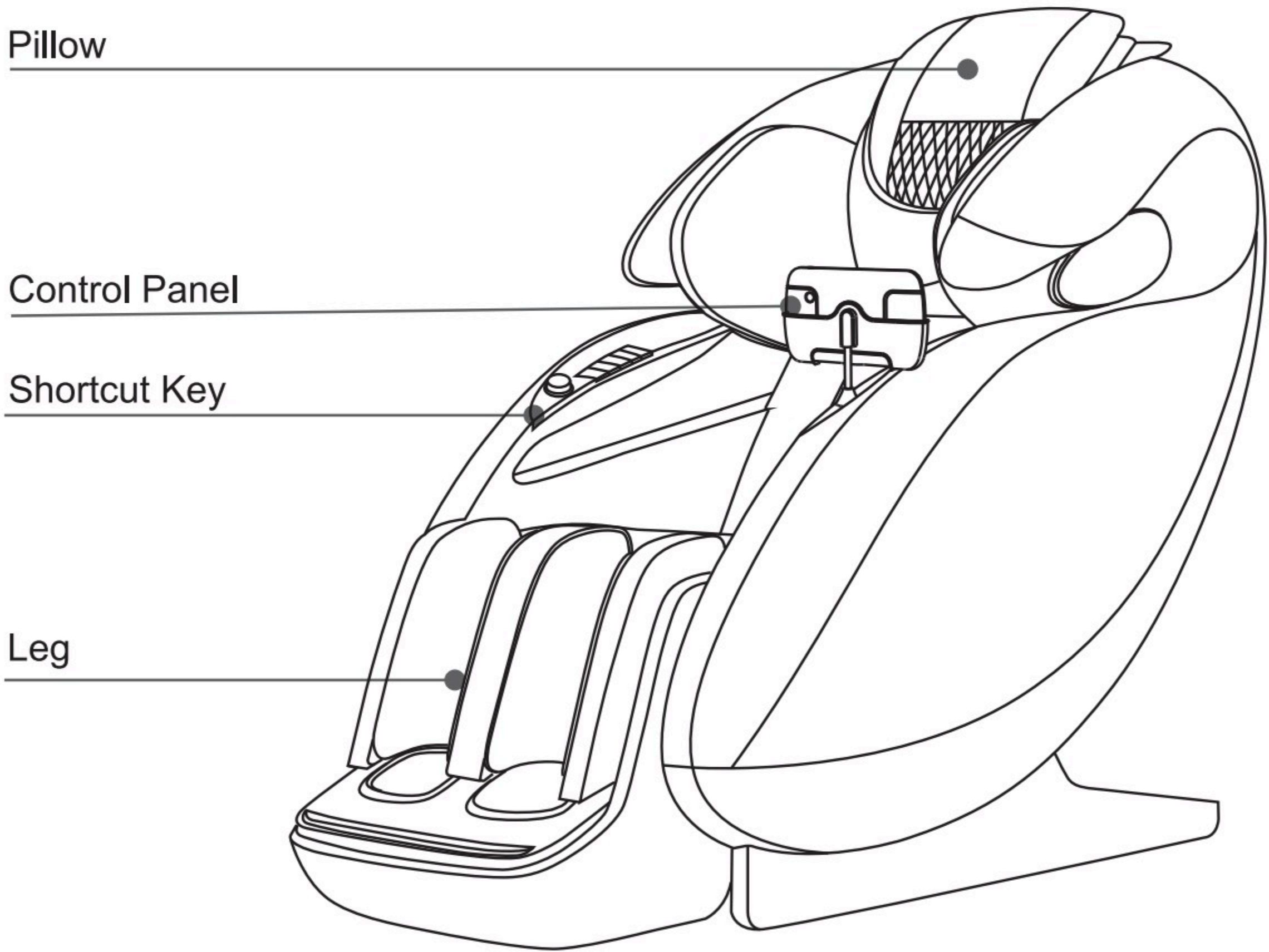

Side view

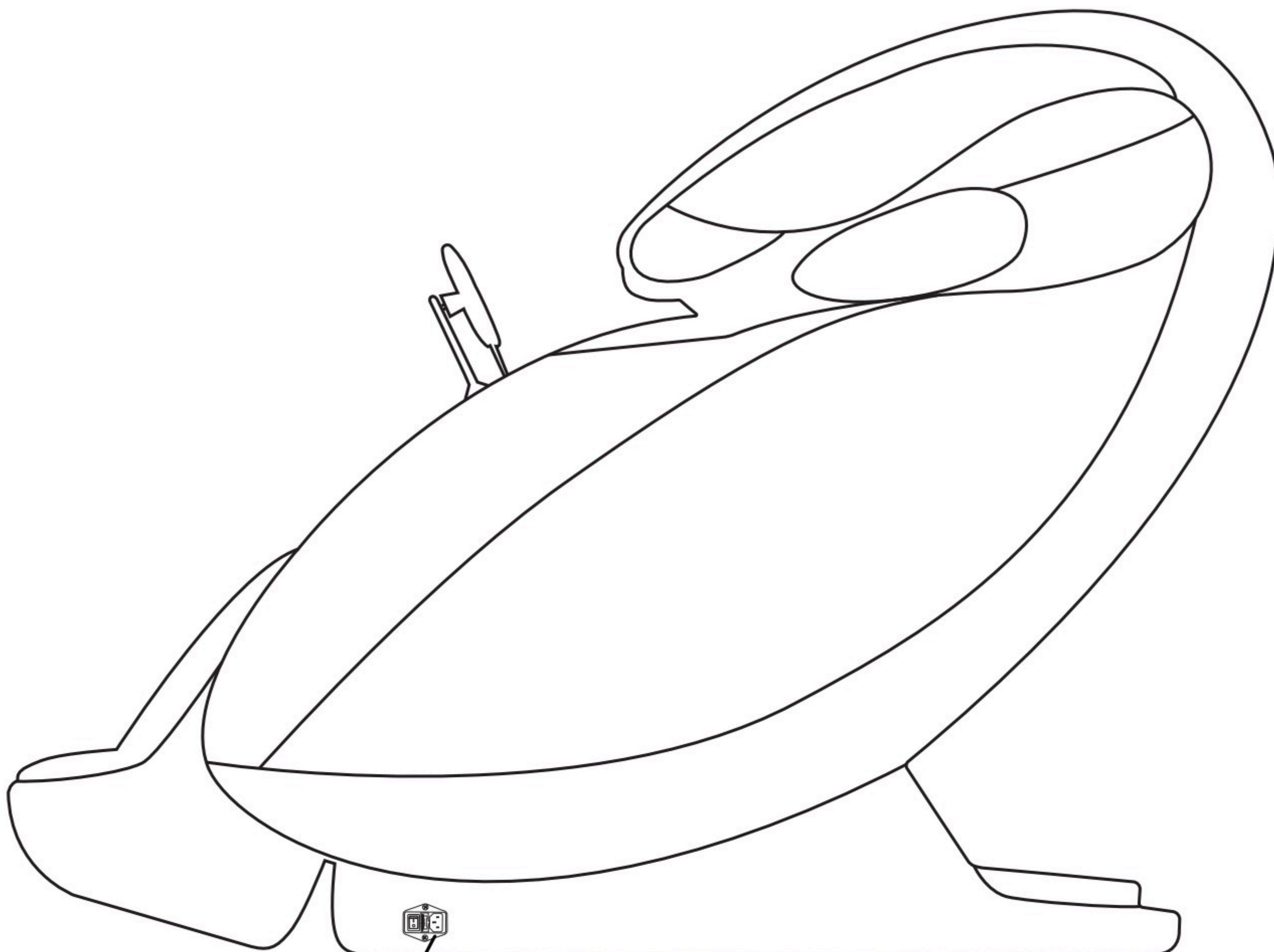

ON/OFF Switch

Safety Fuse

Power Plug

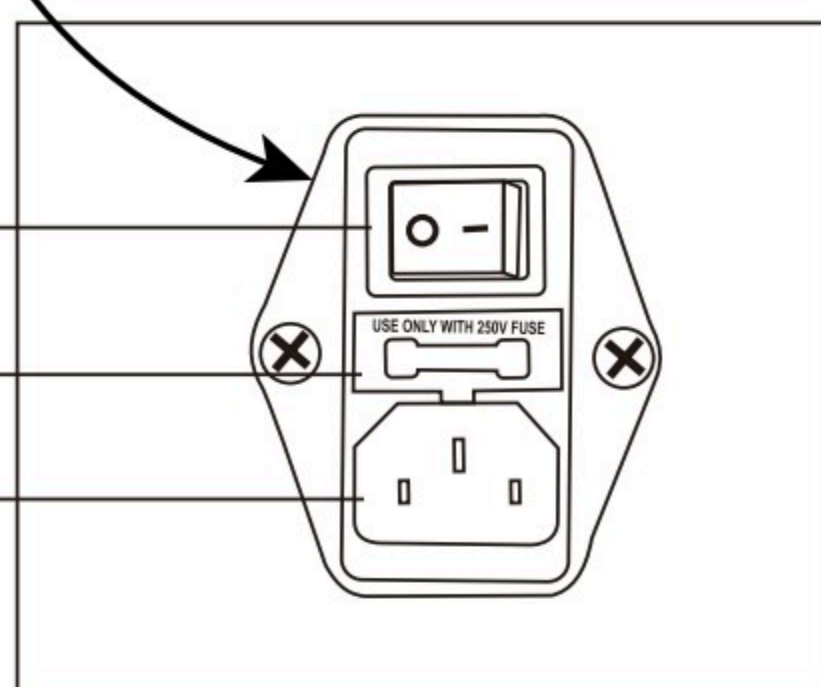

Internal Parts

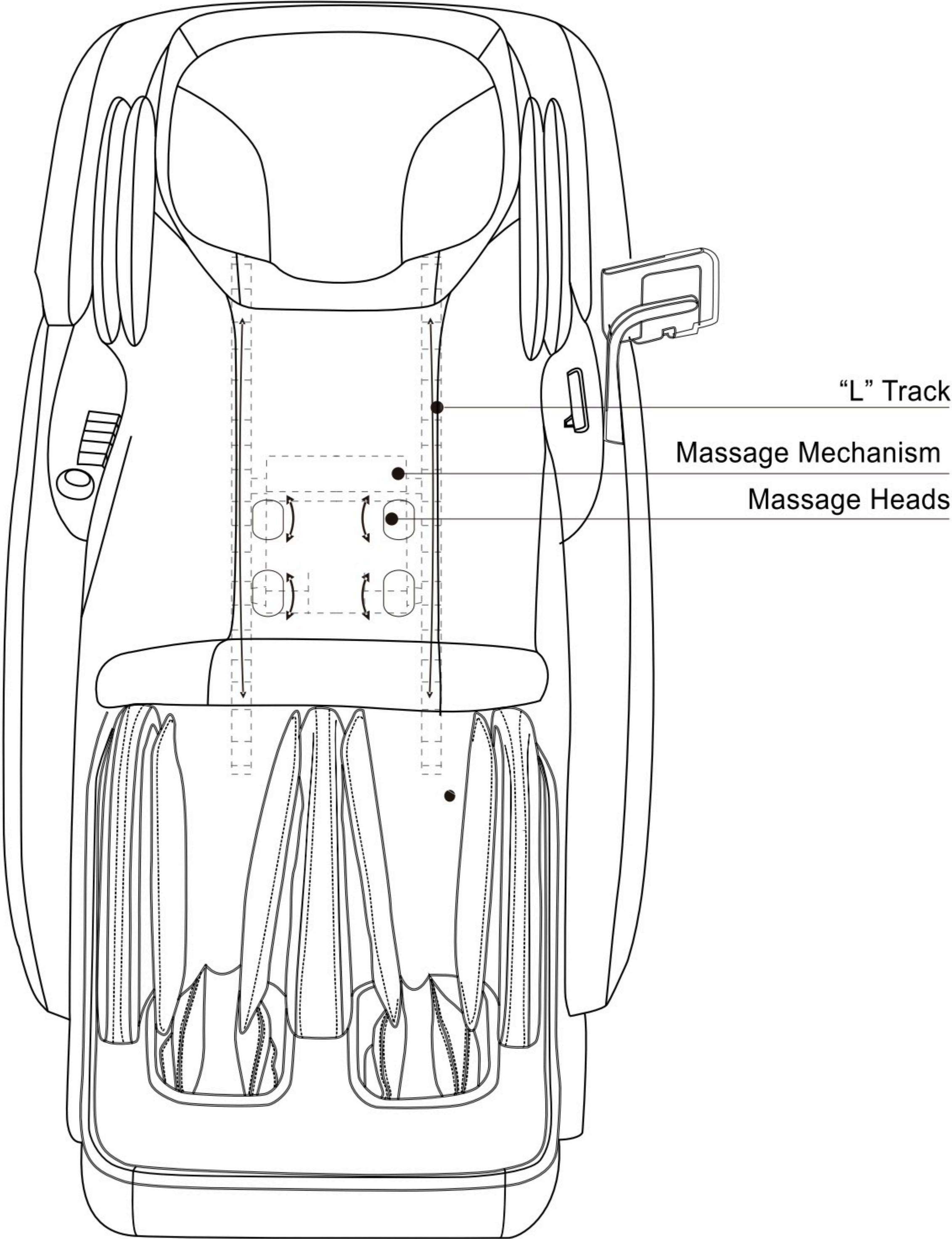

Preparation For Use

1. Remove the package and take out the chair and spare parts

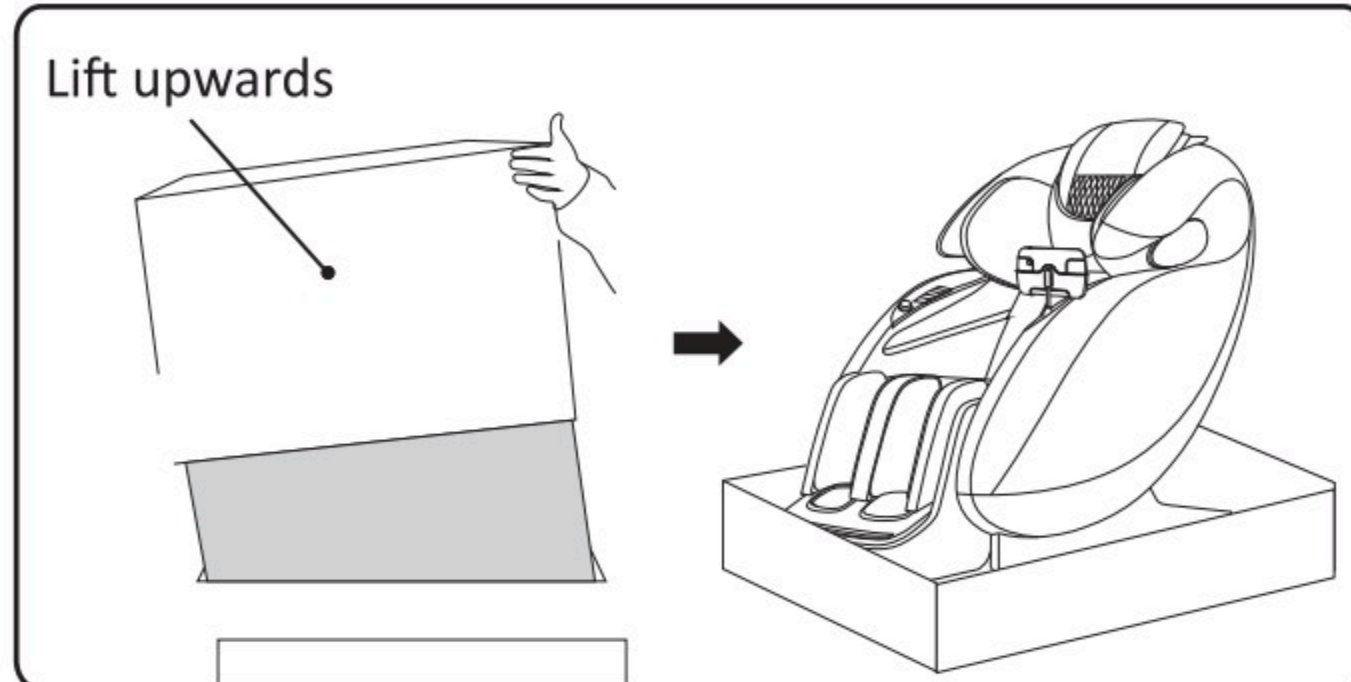

- 1) Remove the carton. Take out the chair.
- 2) Install the pillow and backrest cover.

2. Place the chair in an open area

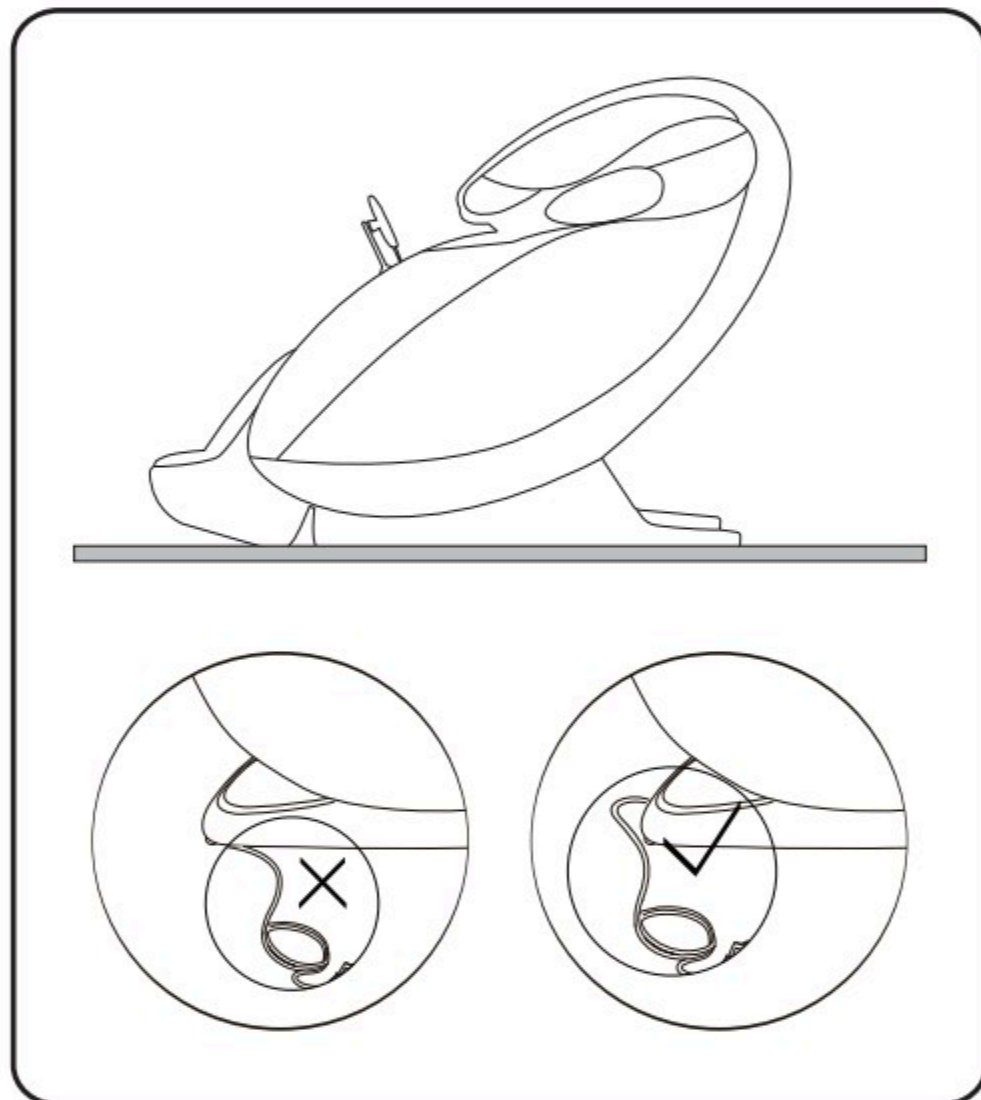

- Allow sufficient space around the chair for reclining purposes.
- To avoid damage to the floor and to reduce noise, please put a rug under the chair.
- Make sure that there is no barrier at the front and the back of the chair.
- Please do not put the chair on wet or uneven floor.
- To avoid signal interference, please place the chair 1 meter away from TV and radio.
- Do not expose the chair to direct sunlight or a high temperature place. Otherwise its leather may fade or harden.

Warning:

Do not put the power cord under the chair! Be ware of damaging the power cord while moving the chair!

3. Move the chair

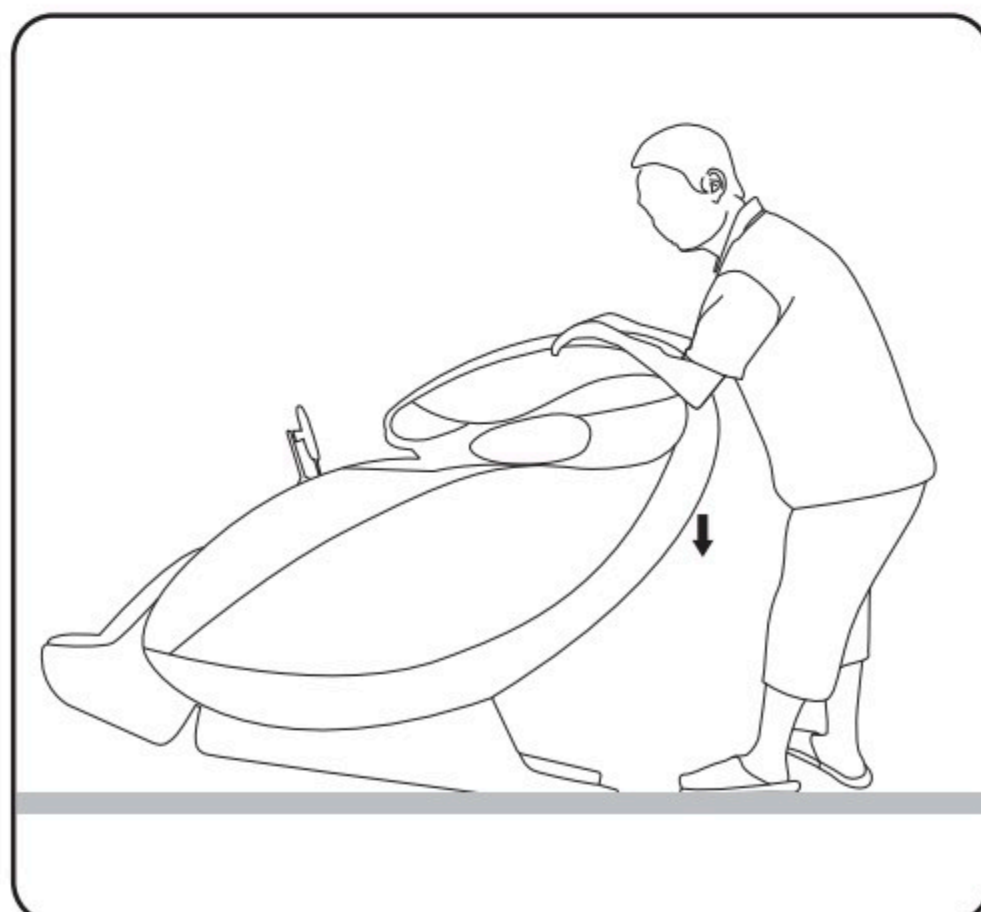

- 1) As illustrated, push the backrest downwards and tilt chair on to its wheels at a 45° angle.
- 2) Slowly push and move the chair to the desired location.
- 3) Lower the chair slowly and smoothly until it is fully flat on the ground.

Warning:

- Before moving the chair, adjust the footrest back to its original position.
- Do not move the chair when occupied or in use.
- Moving the chair may cause damage to the floor. Floor protection is recommended (e.g. rugs or carpet).
- Do not drop or suddenly let go of the chair while moving as it may damage the chair.
- Two persons are recommended when moving the chair and extra care is required.

1. Control Panel Installations

Take The Tablet Controller And Pass The Tablet Controller Line Through The Elastic Bag (2) Under The Air Bag Blade In Turn.

Insert Into The Usb Terminal At The Bottom Of The Chair, And Finally Insert The Tablet Controller Bracket Into The Base, And The Tablet Controller Is Installed.

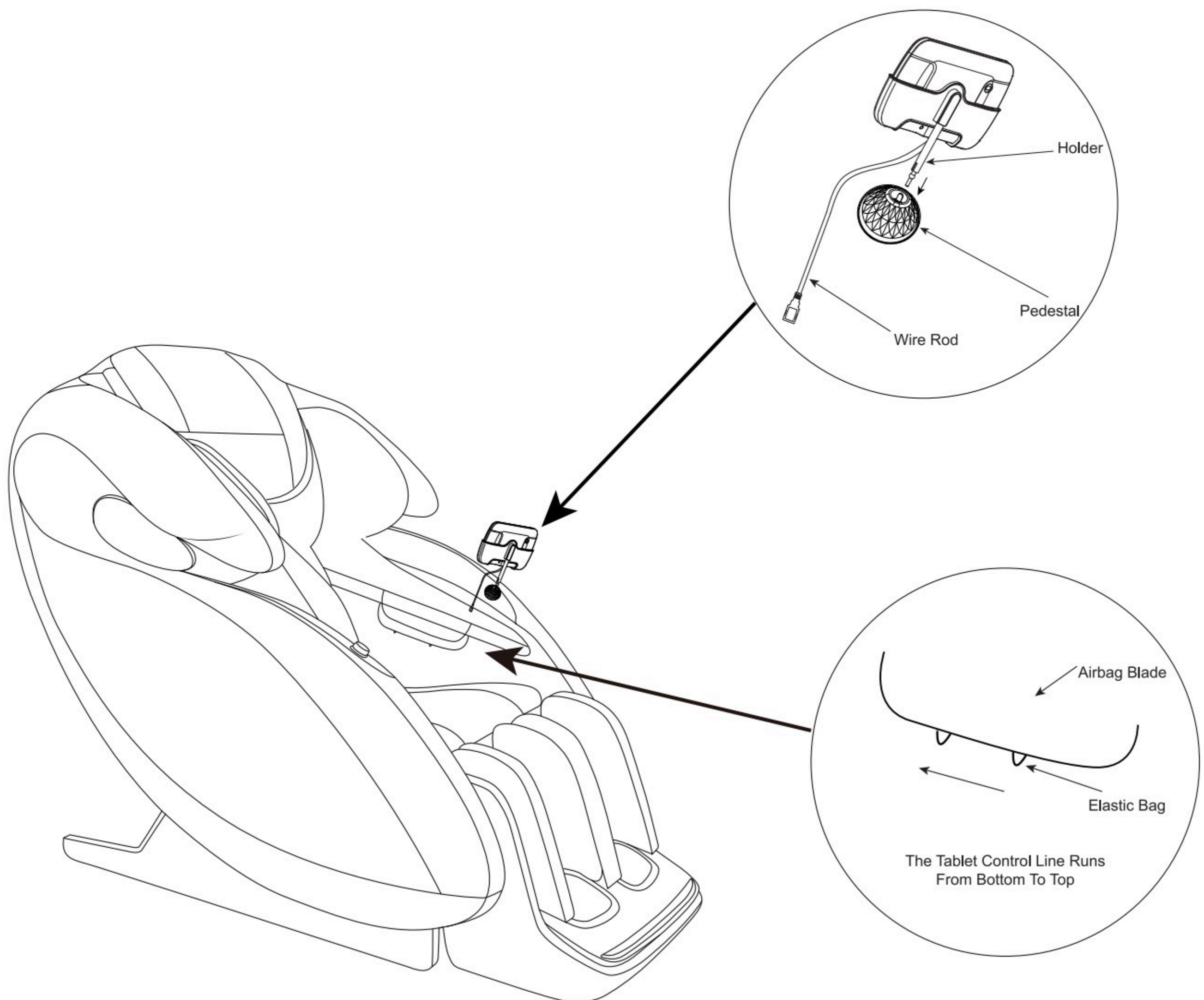

2. Cloak Installations

Take out the cloak, first disassemble the D button on the head of the chair, and then remove the central ribbon between the head of the cloak and the head of the chair. Assemble with a D-buckle and zip up at last. The assembly of the mantle seat is the same as above.

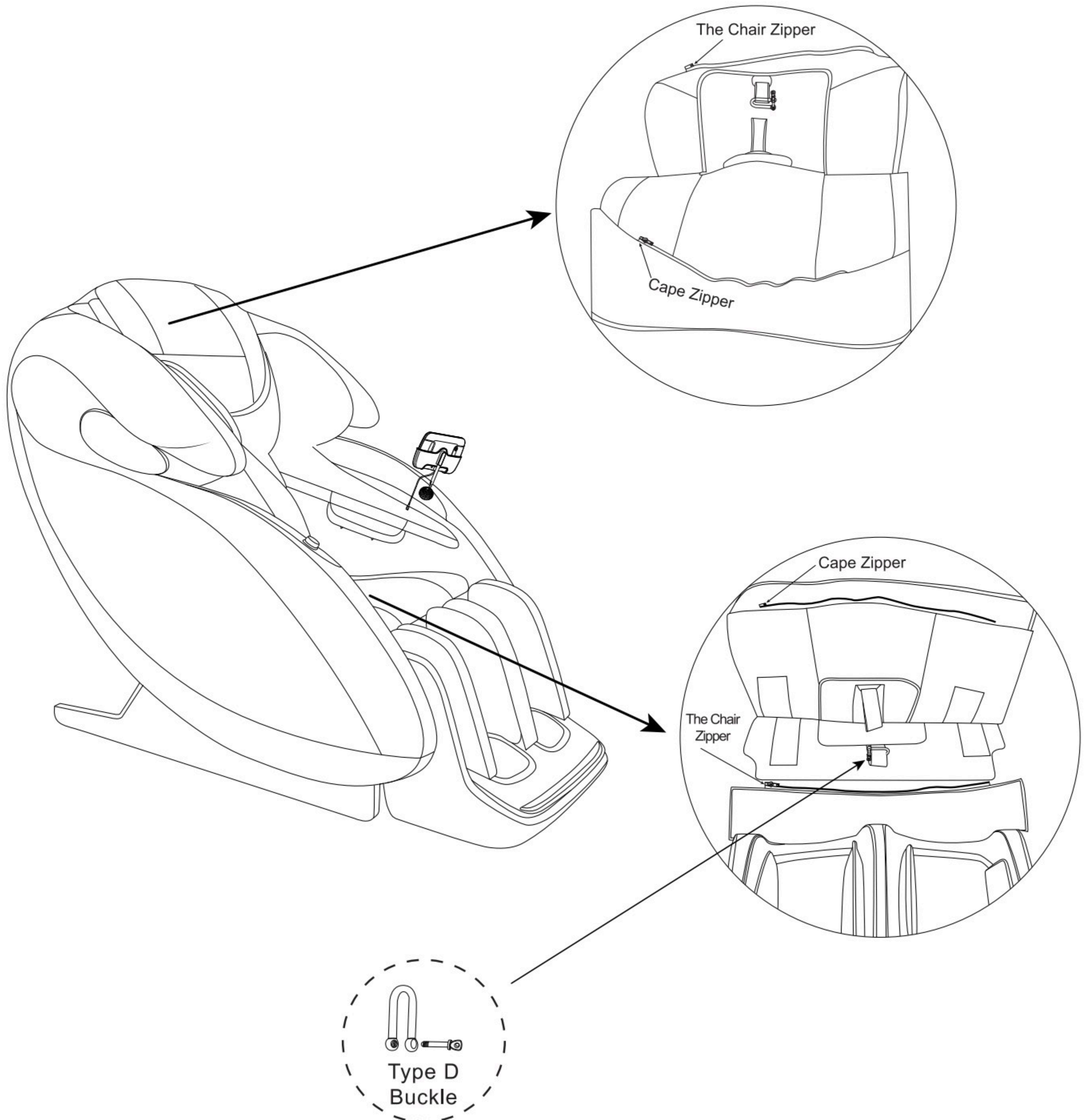

Installation Instructions

3. Leg Installations

1) Open the box, slowly take out the massage chair and lower legs, and check whether the installation accessories are complete

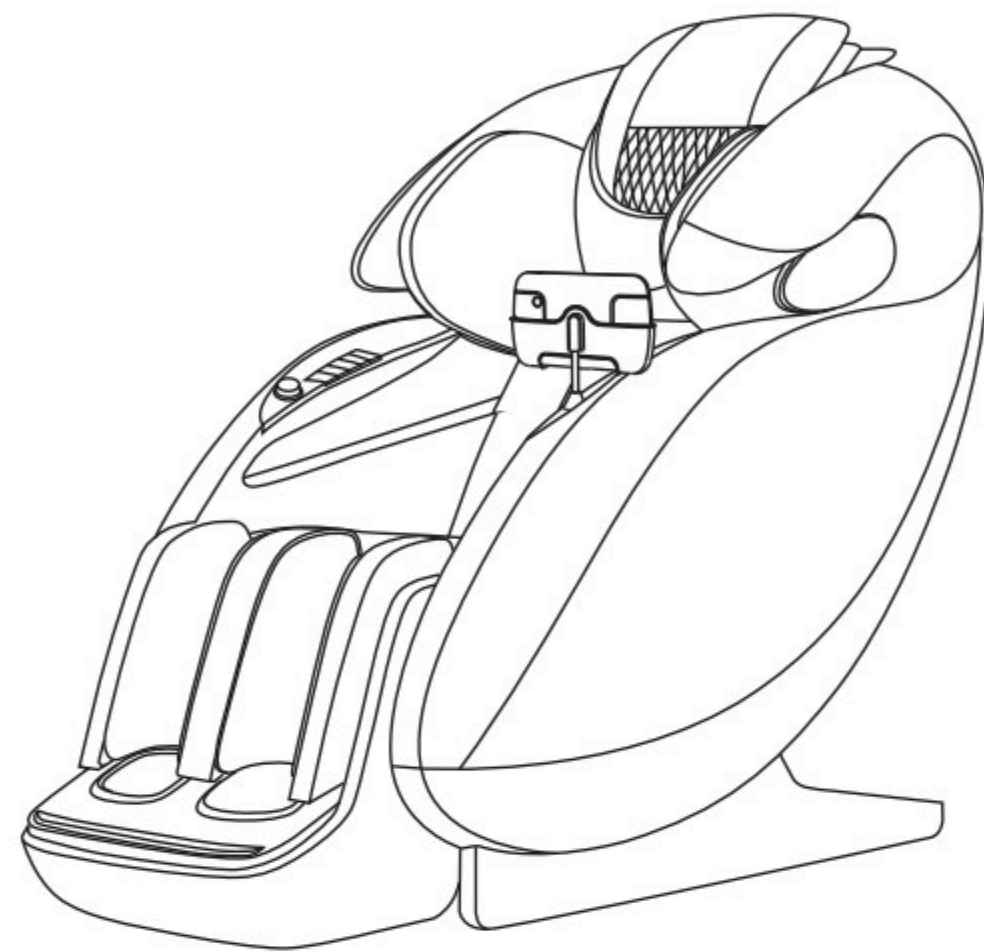
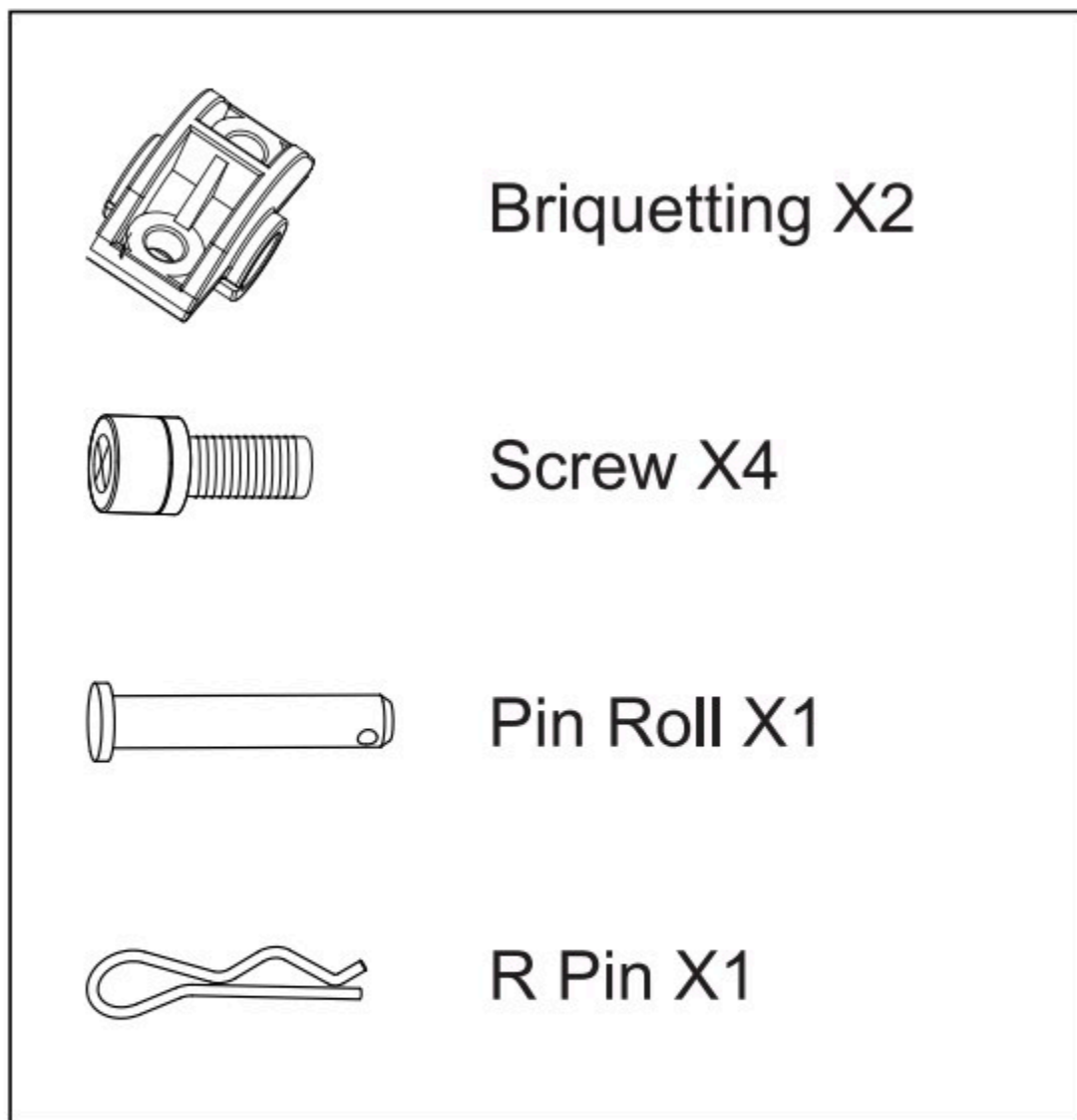

2) Place the shank movable shaft in the slot, then install the leg press and tighten the cross screws with the appropriate tool

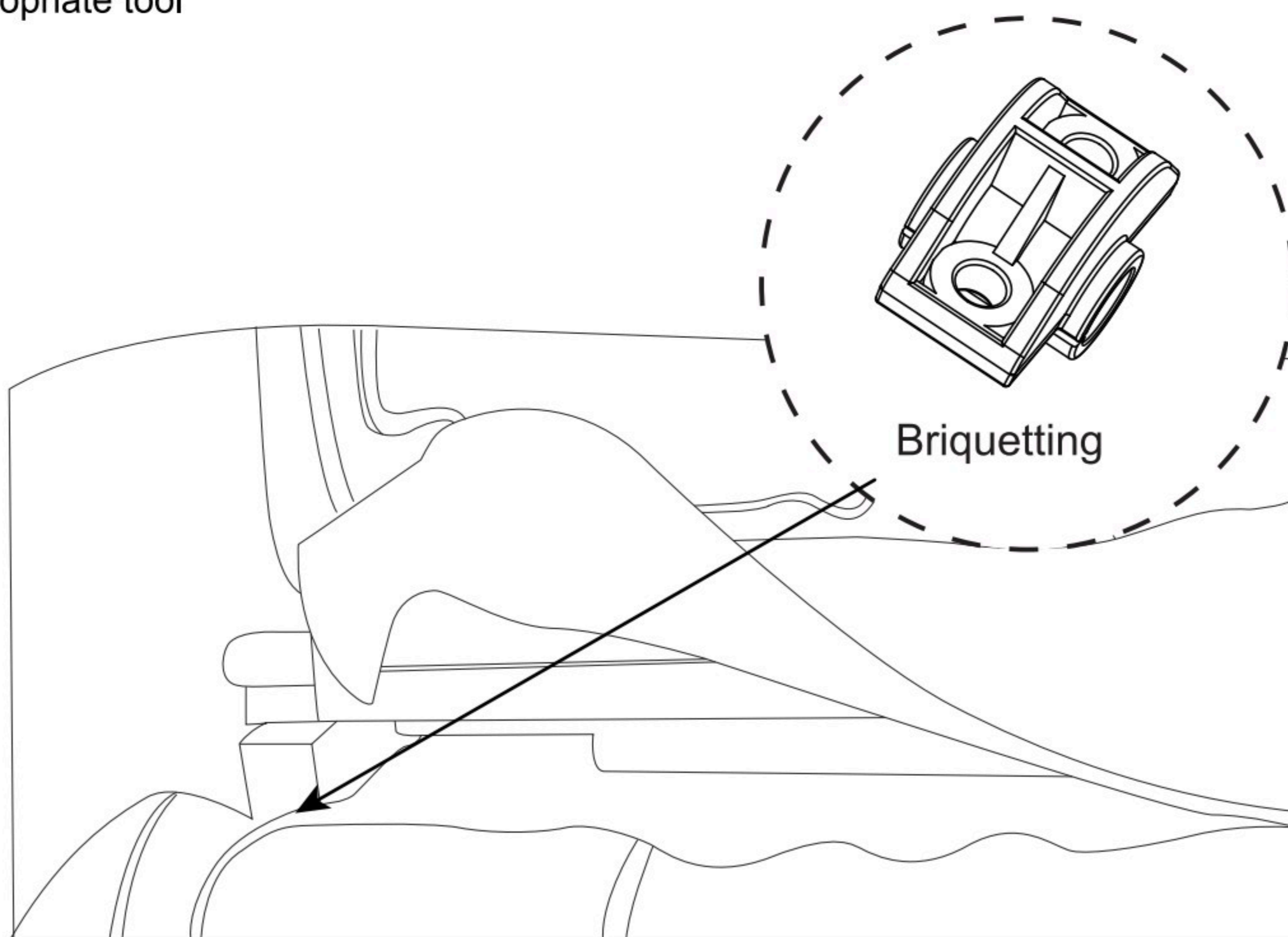

Installation Instructions

3) Install Leg Link Shaft

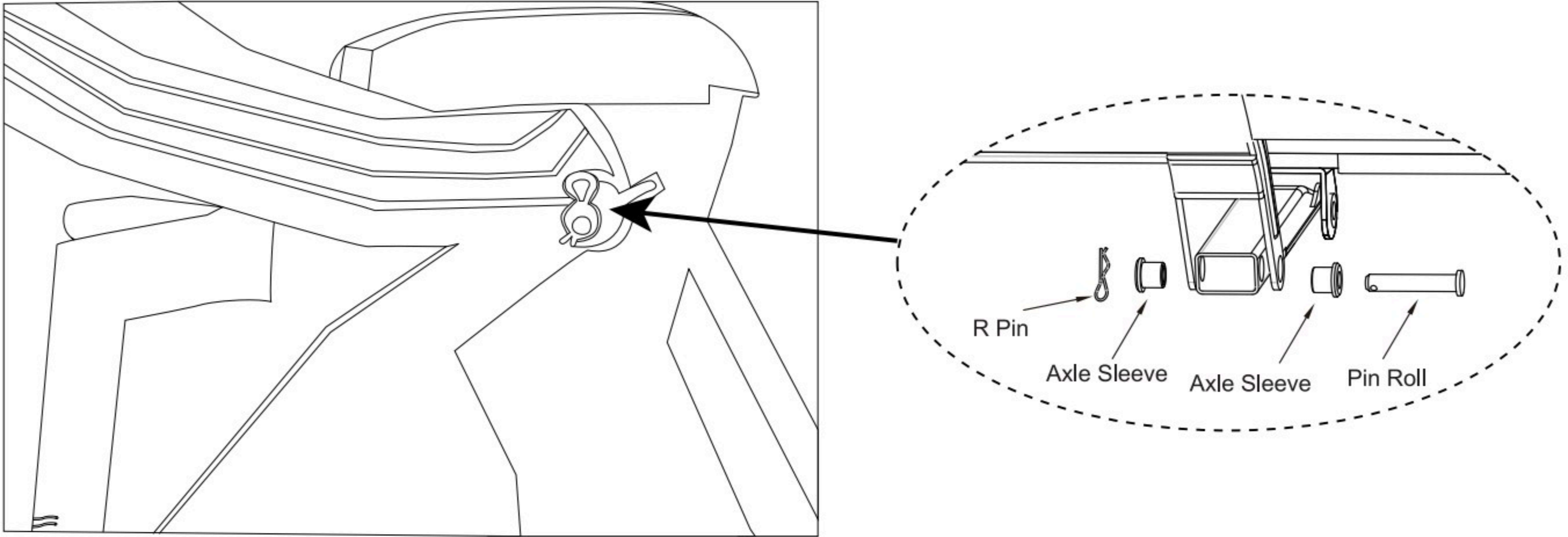

4) Connect The Female connector To The Air Pipe

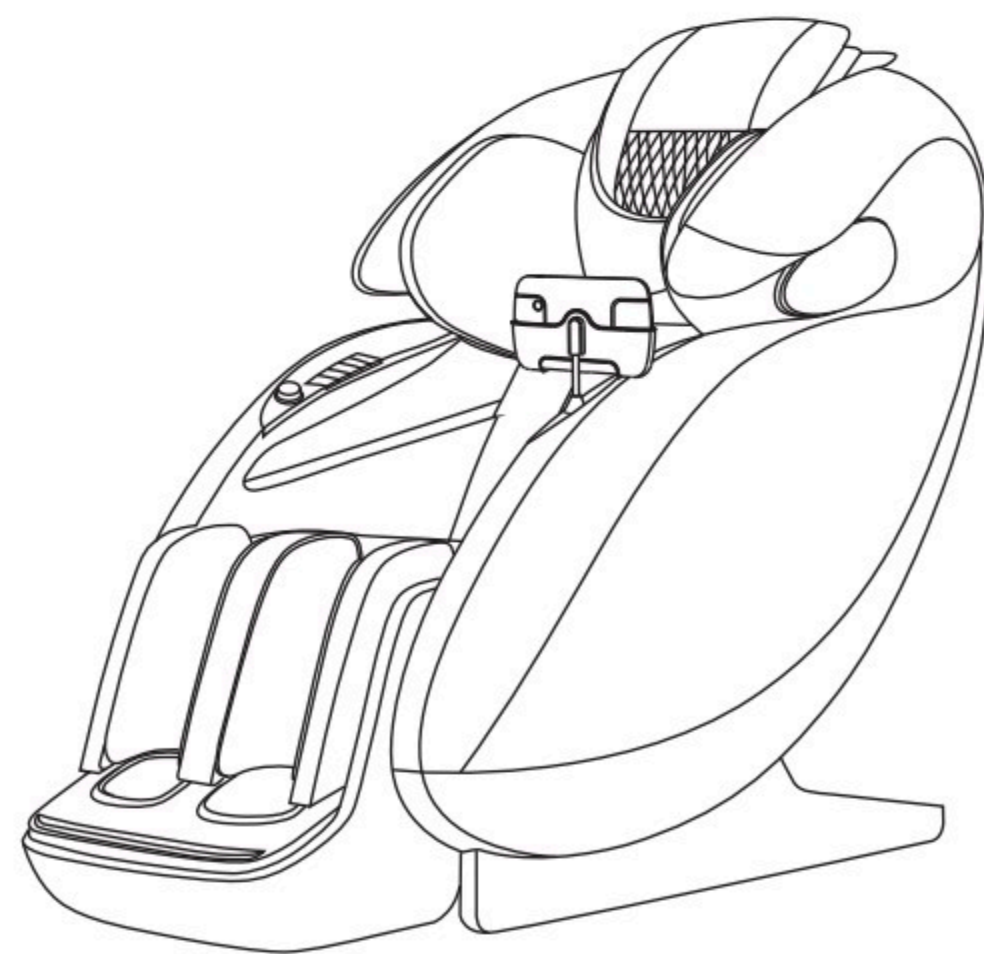
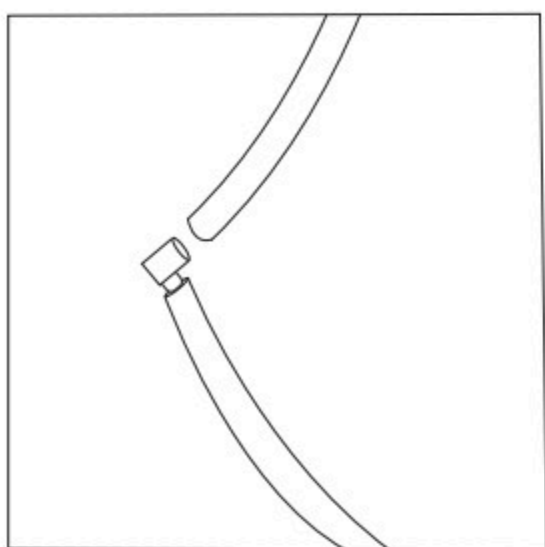
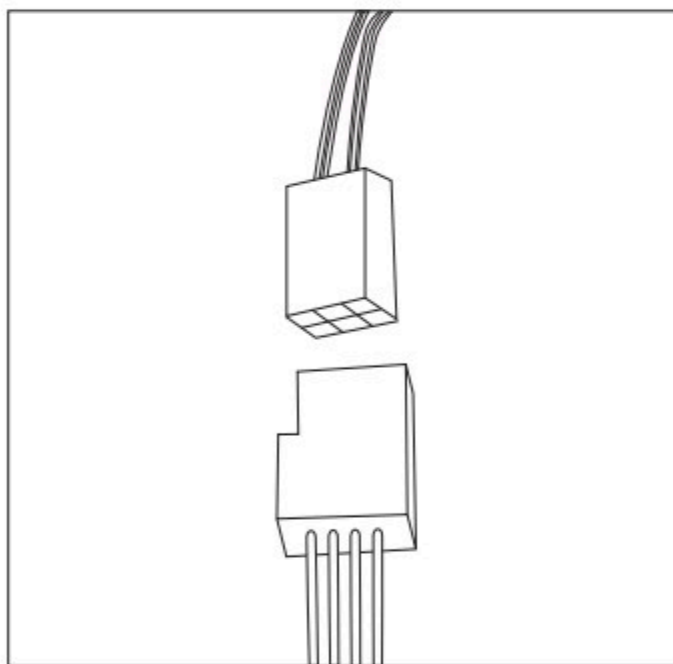

1. Remote Controller Description

ON/OFF



Control Panel

1.1 Main Menu

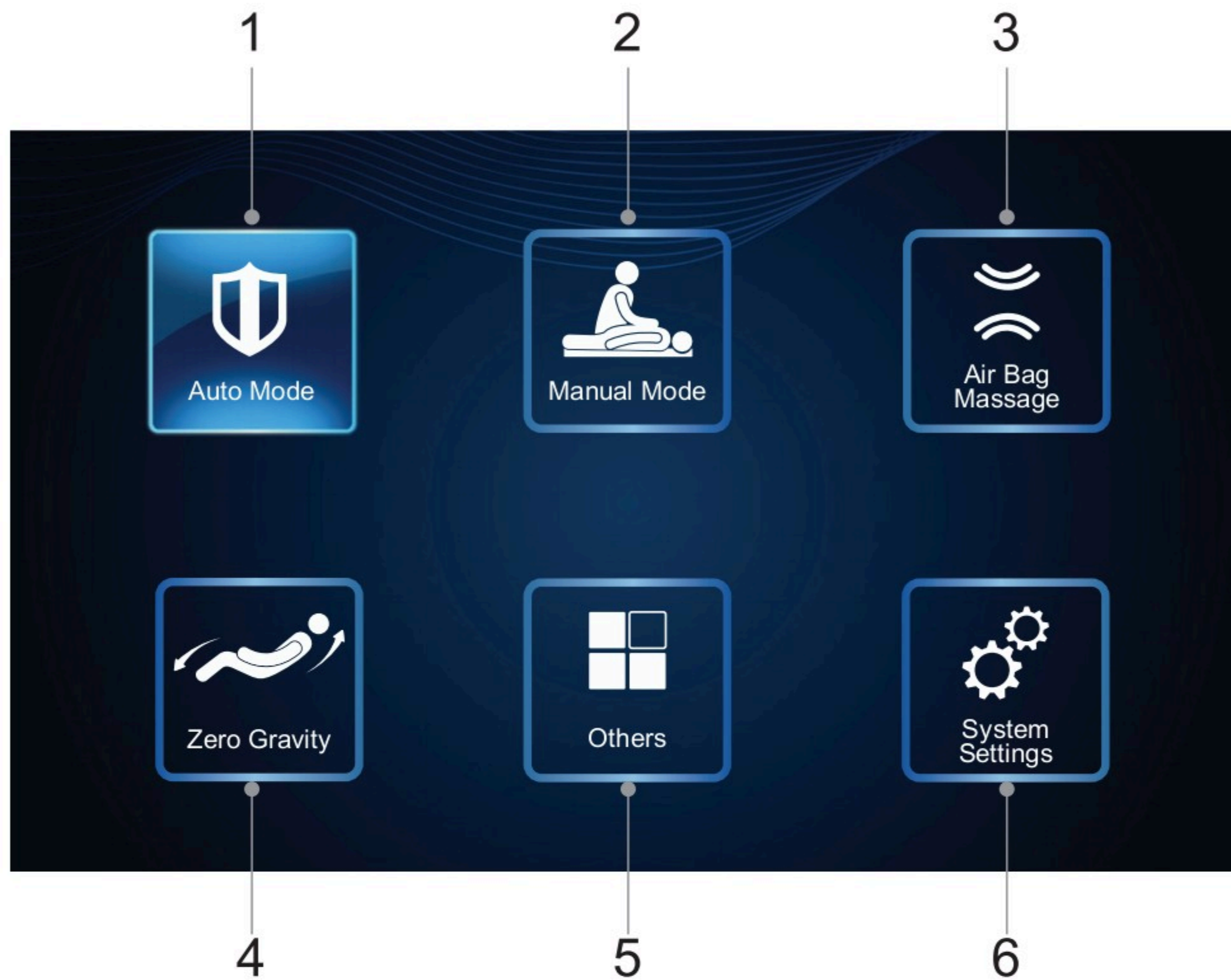

1.Auto Mode

2.Manual Mode

3.Airbag Massage

4.Zero Gravity

5.Others

6.System Settings

1.2 Auto Mode



Auto Mode Interface 1

① Full Body Relaxation

② Chinese Massage

③ Japanese Massage

④ Handstand Stretch

⑤ Lay Down To Sleep

⑥ Super Stretch

Control Panel

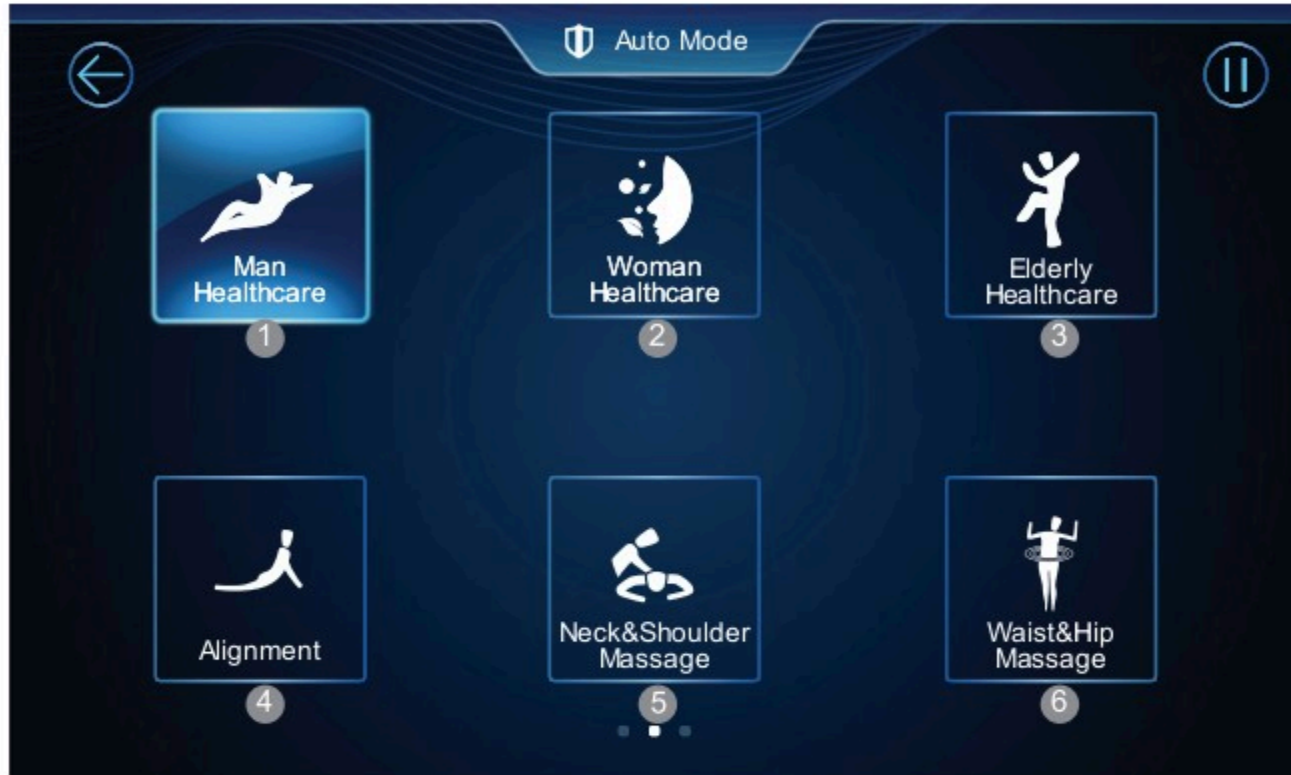

Auto Mode Interface 2

- ① Man Healthcare Mode
- ② Woman Healthcare Mode
- ③ **Elderly Healthcare Mode**
- ④ **Alignment Mode**
- ⑤ Neck& Shoulder Massage Mode
- ⑥ Waist& Hip Massage Mode



Auto Mode Interface 3

- ① Exercise Relaxation Mode
- ② Release Pressure Mode
- ③ Full Body Air Pressure Mode
- ④ Upper Body Mode
- ⑤ Lower Body Mode
- ⑥ Quick Massage Mode



Auto Mode Interface 4

- ① 4D Adjust
- ② Speed Adjust
- ③ Time
- ④ Air Pressure Adjust
- ⑤ Heating
- ⑥ Foot Roller
- ⑦ Calf Roller

Control Panel

2.3 Manual Mode

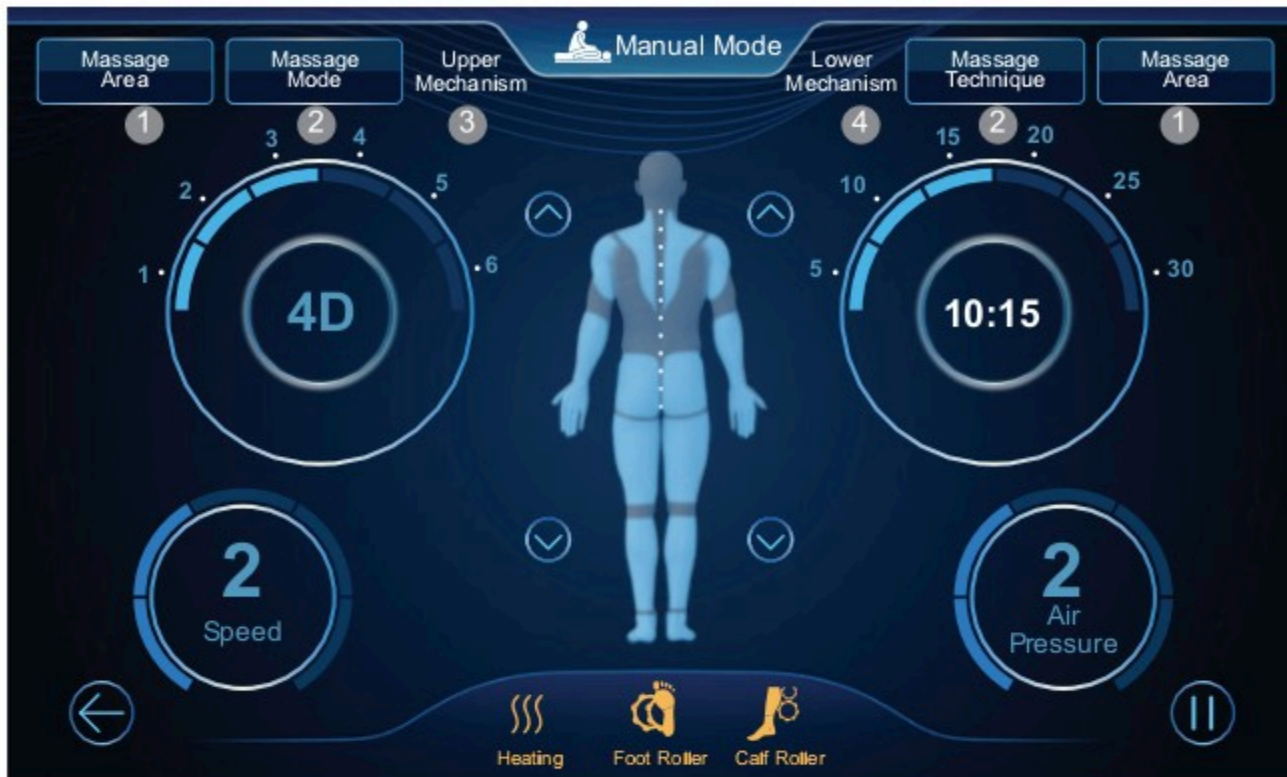

Massage State Interface 1

- ① Massage Area Setting
- ② Massage Manipulation Setting
- ③ Upper Mechanism Setting
- ④ Lower Mechanism Setting

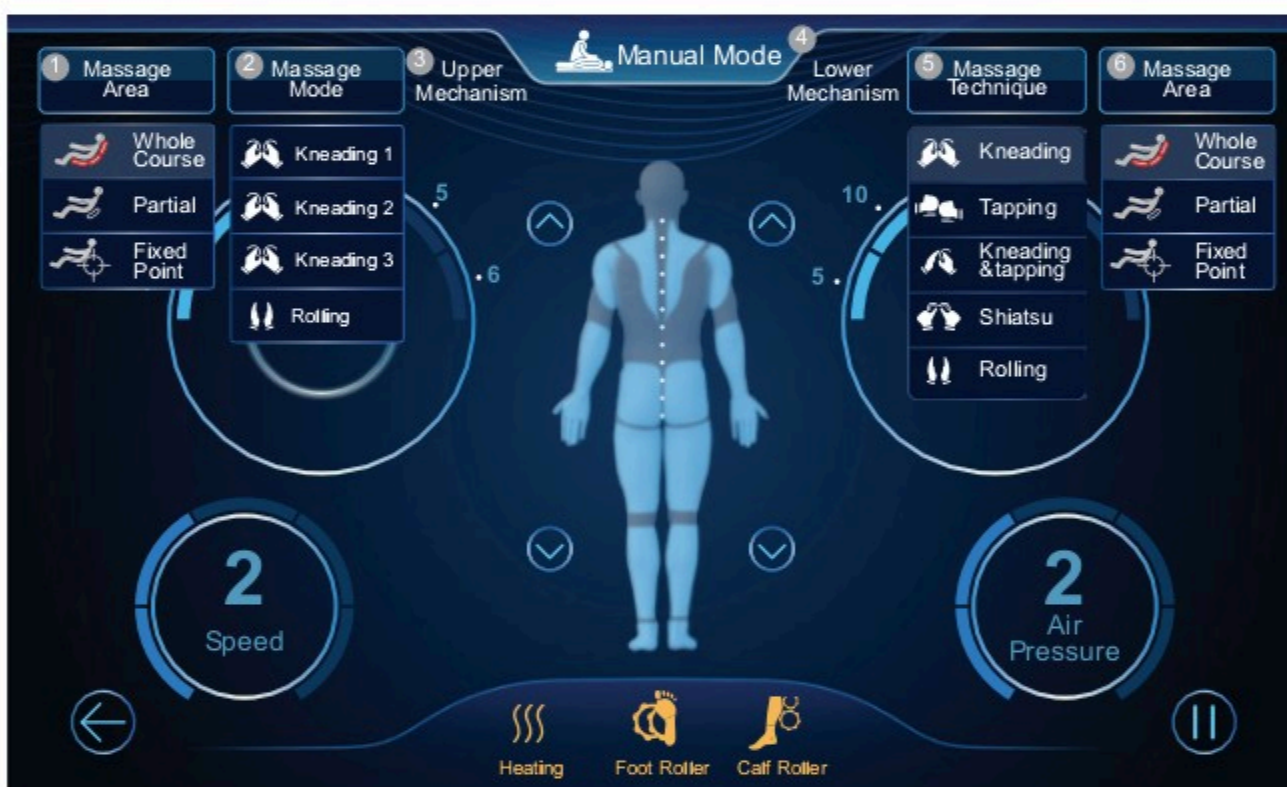

Massage State Interface 2

- ① Massage Area
- ② Massage Manipulation
- ③ Upper Mechanism
- ④ Lower Mechanism
- ⑤ Massage Manipulation
- ⑥ Massage Area

2.4 Air Bag Massage

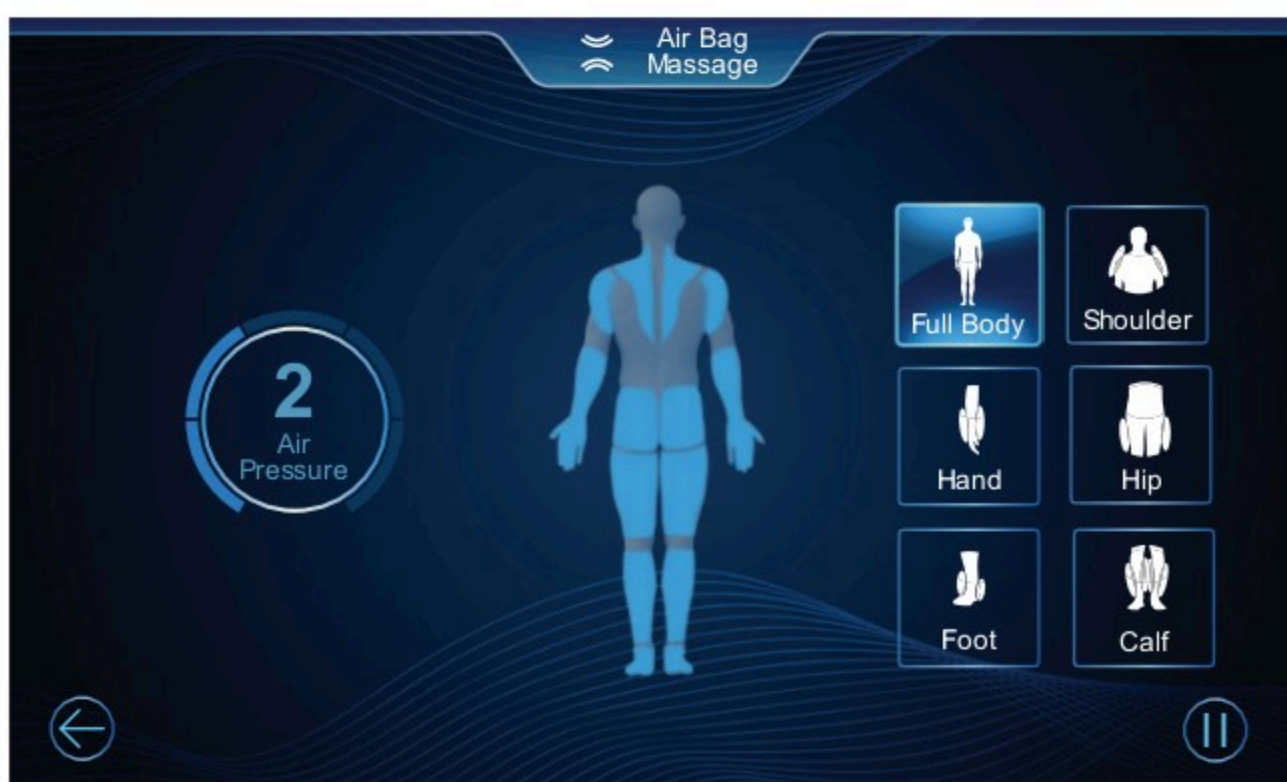

- ① Full Body Air Bag
- ② Shoulder Air Bag
- ③ Hand Air Bag
- ④ Hip Air Bag
- ⑤ Foot Air Bag
- ⑥ Calf Air Bag

Control Panel

2.5. Zero Gravity



- ① Zero Gravity Angle
- ② Best Angle For Watching TV
- ③ Best Angle To Read

2.6. Others

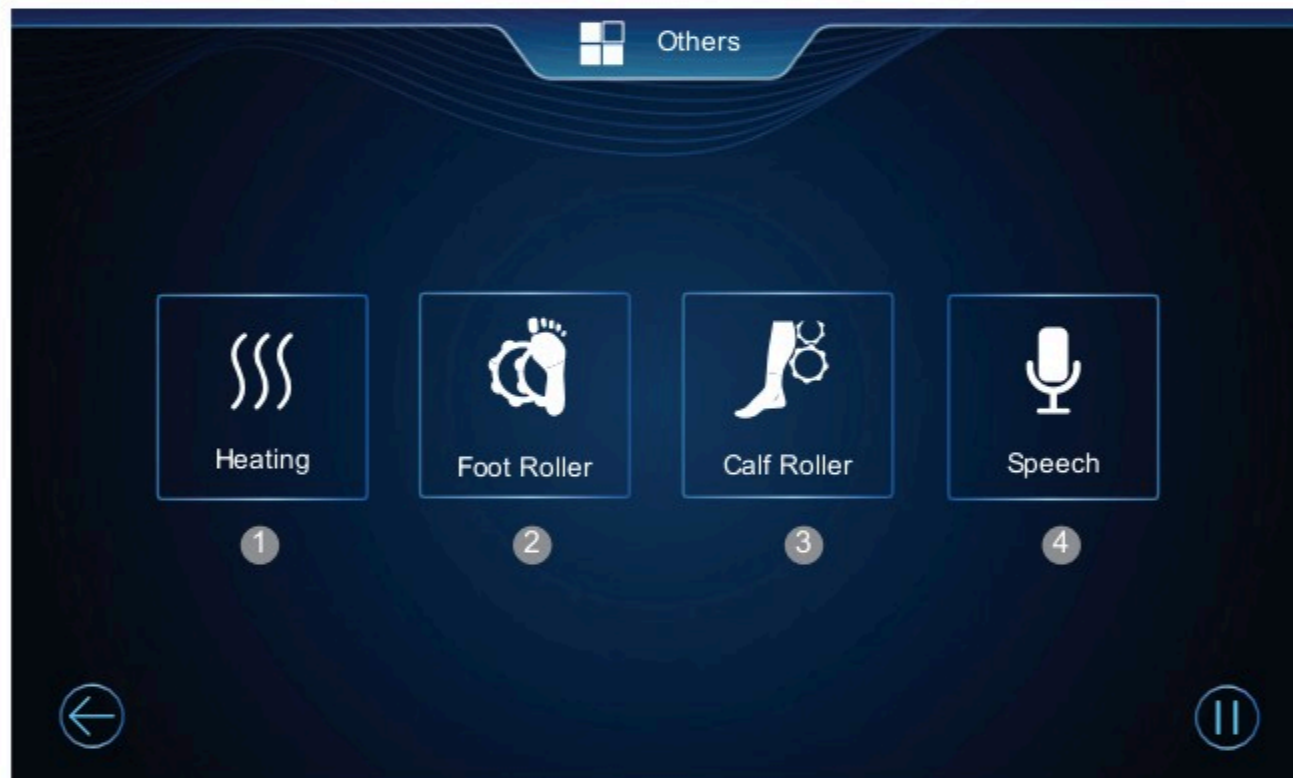

- ① Heating
- ② Foot Roller Massage
- ③ Calf Roller Massage
- ④ Speech

2.7. System Settings



- ① Intensity Control
- ② Volume Adjustment

3. Shortcut Button Description

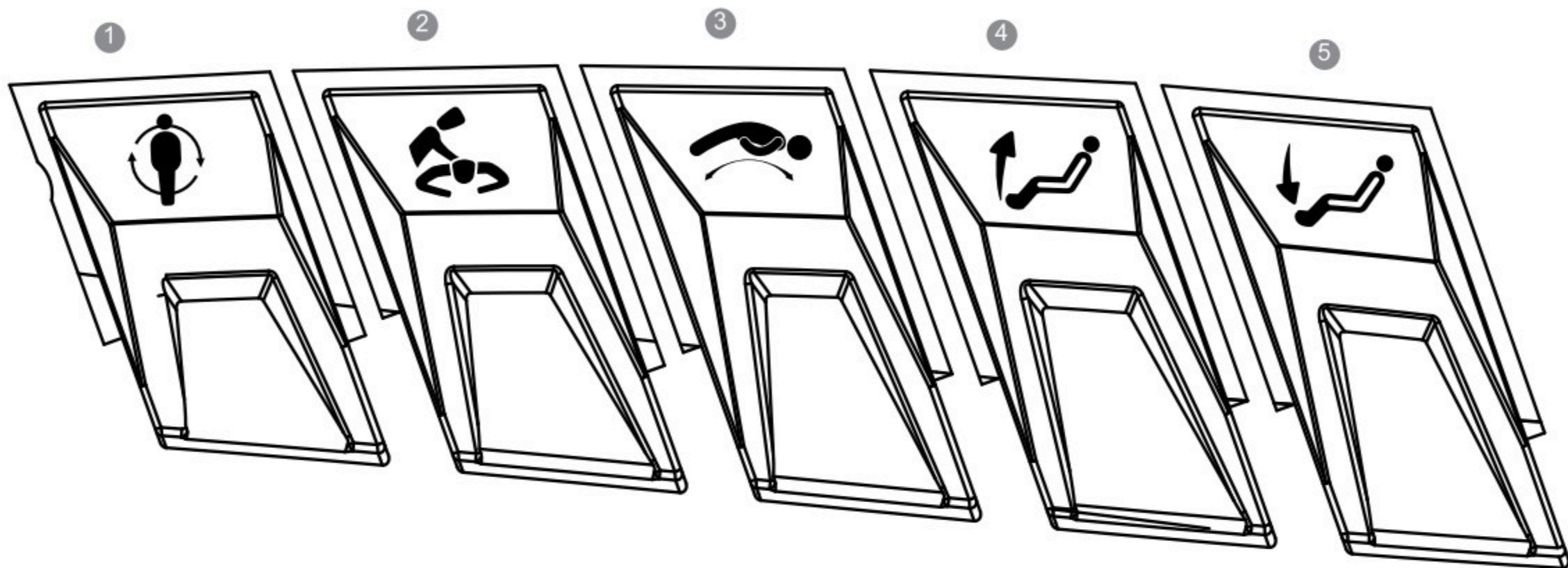

① Full Body Relaxation

② Neck & Shoulder Massage

③ Handstand Stretch

④ Leg Up

⑤ Leg Down

4. Switch Key And Knob Key



Switch key: Long press this button to turn on/off the massage chair

Knob key: Clockwise to Recline; and Anticlockwise to Raise

Control Panel

5. After Use

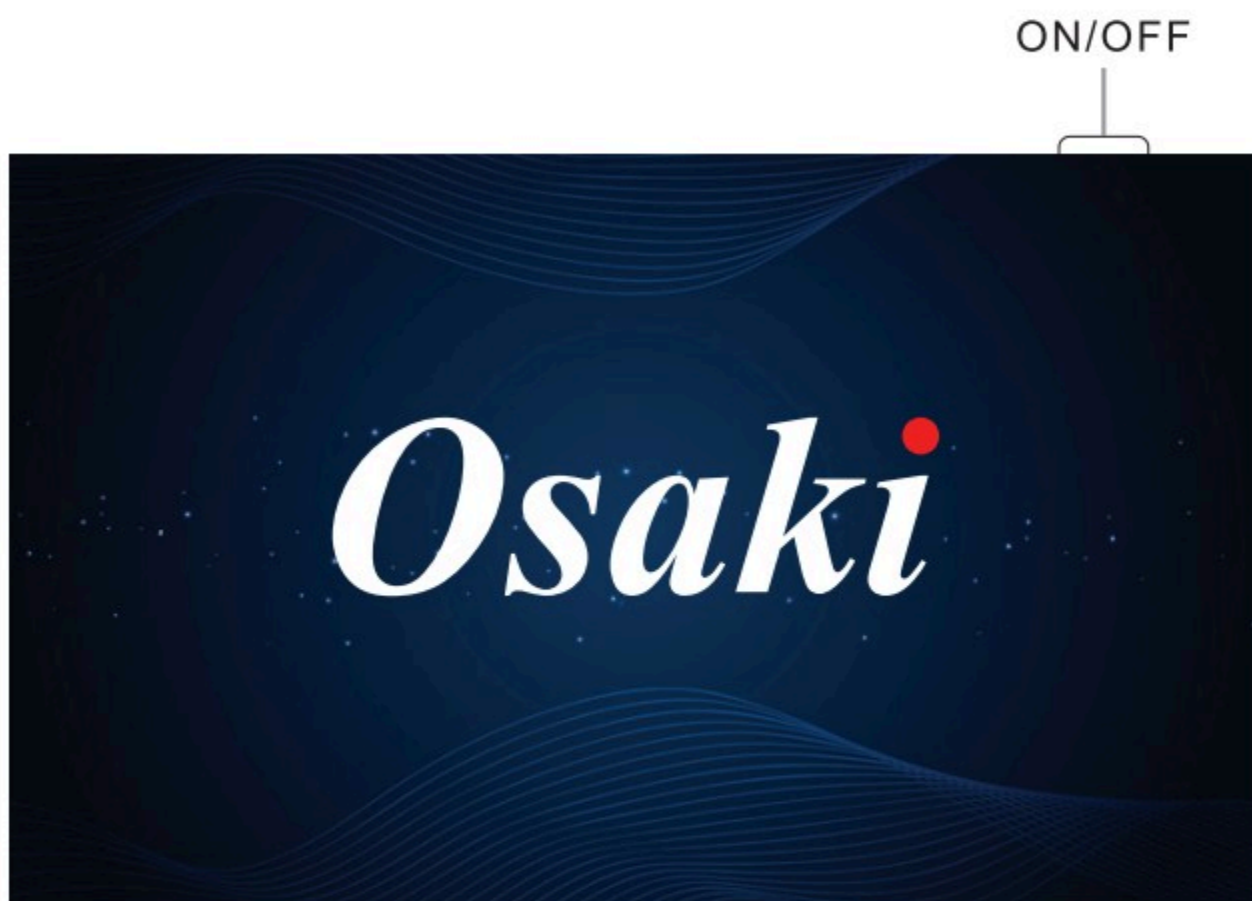

1) Press the On/Off button to disable all functions.

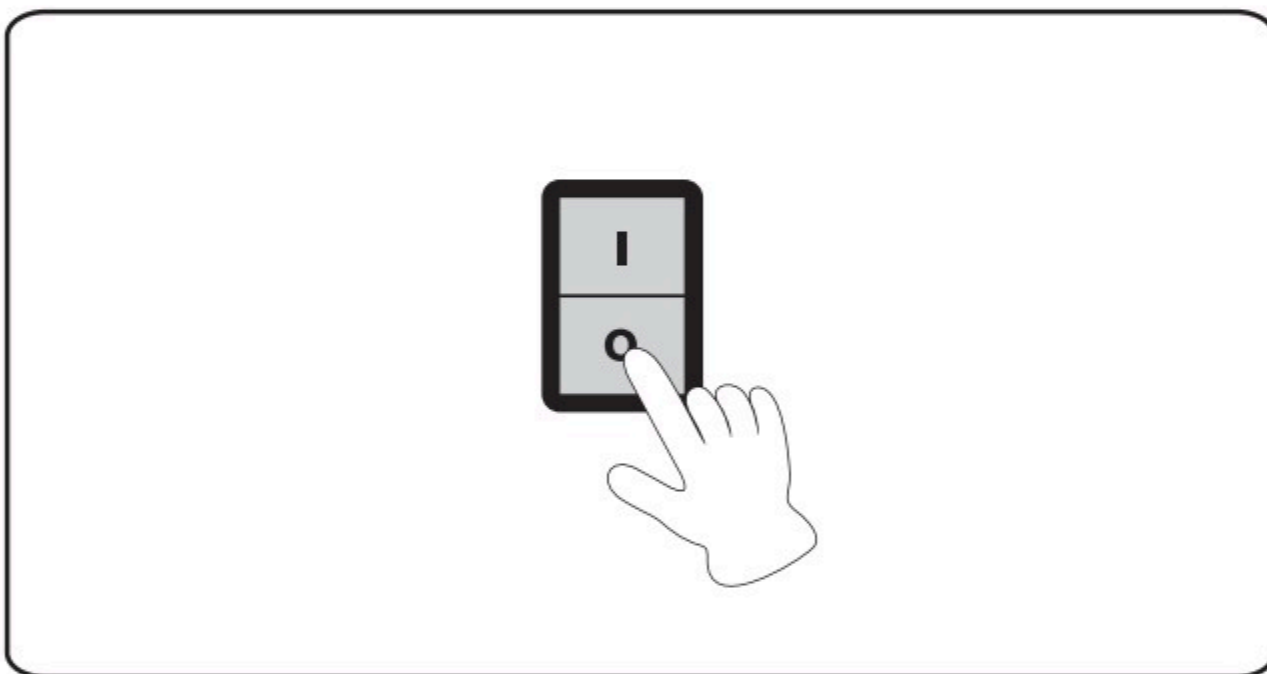

2) Turn off the power switch (to "O") located at the back of the chair.

See Page 5

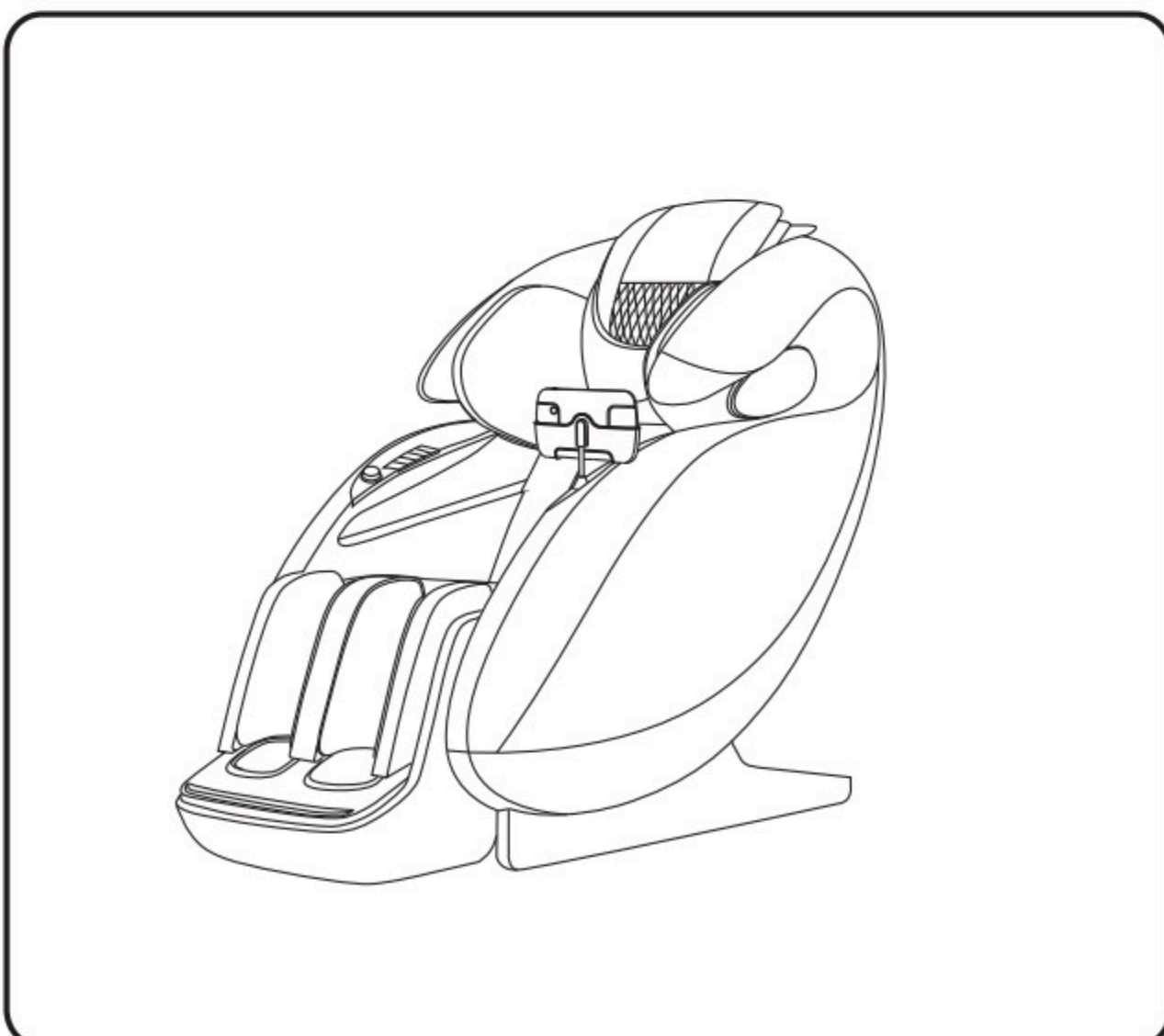

3) Remove plug from power socket.

*** Please do not pull on the power cord to remove the plug.**

Control Panel

The voice commands are as follows:

Voice Control entry			
Awakening Word: "Hi Osaki." Answer: "Hello"			
No.	Voice Control entry	No.	Voice Control entry
1	Turn on massage	17	Turn on Foot Roller
2	Turn off massage	18	Turn off Foot Roller
3	Leisure massage	19	Turn on heat
4	Stretching massage	20	Turn off heat
5	Swing mode	21	Volume up
6	Strong massage	22	Volume down
7	Sleep massage	23	Maximum volume
8	Neck and shoulders relax	24	Minimum volume
9	Increase intensity	25	Backrest down
10	Reduce intensity	26	Backrest up
11	Maximum intensity	27	Zero gravity
12	Minimum intensity	28	Raise leg
13	Turn on airbag	29	Lower leg
14	Turn off airbag	30	Pause massage
15	Increase air pressure	31	Start massage
16	Reduce air pressure		

The voice mode is automatically activated when power on. If the voice function is disabled, enable it again by choosing on the screen. When the voice function is enabled successfully, please wake up the chair by calling "Hi Osaki" first and you will see the chair responds "Hello". And the next command you need to call is "Turn on massage" to activate the starting function of chair and you can use other commands then. The chair need to be woken up after every 8 seconds of rest. Please note that Intensity and air pressure adjustment can only be effective when the corresponding function is turned on, otherwise it is invalid. For example, you need to open the air bag massage before you request it to increase air pressure.

This page summarizes the most common problems you would encounter with the product. If you are unable to solve the problem with the information below, please contact its authorized dealers immediately.

Problem	Possible Cause	Suggestion
The product does not work	The product is not plugged in properly.	Ensure the voltage on the product corresponds to the local mains voltage and then plug in again. Then turn on the power switch.
	The product has just finished its 15-min auto timer session and has automatically switched to standby mode.	If you want another session, press the ⏻ button again.
	You may have used the product continuously for more than 45 minutes and the overheat protection has been activated.	Unplug the product and let it cool down for 60 minutes before you use it again.
	An excessive load has been applied on the product.	Reduce the excessive load and start again.
The product is abnormally warm	The product is likely to be overused.	Unplug the product and let it cool down before using it again.
Noise can be heard from the product	Noise is made by the mechanical parts of the product.	This is normal and does not mean that the product is faulty.

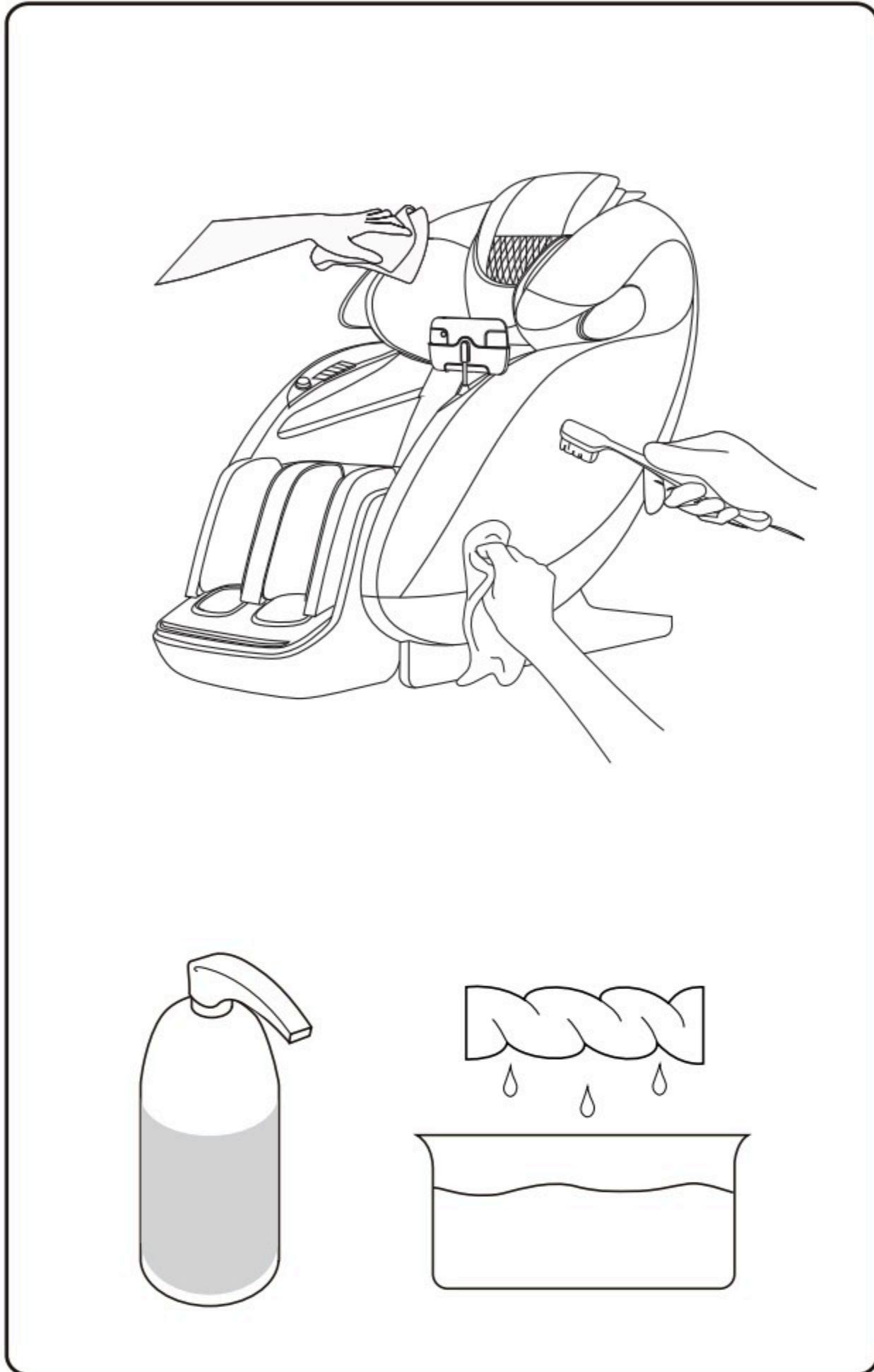

Clean

Never use scouring pads,abrasive cleaning agents(e.g.,benzene or thinner),or harsh chemicals such as petroleum or acetone to clean the chair.

- 1.Shut off and pull out the plug before cleaning the chair.
- 2.Use a dry cloth to clean.
- 3.Do not use a wet cloth and chemical cleanser.

Storage

- 1.Disconnect the massage chair from the power source after use.
- 2.Do not expose the massage chair to direct sunlight,high temperature,or high humidity .This could cause fading or other damage to the upholstery.
- 3.Do not put heavy objects on the massage chair.

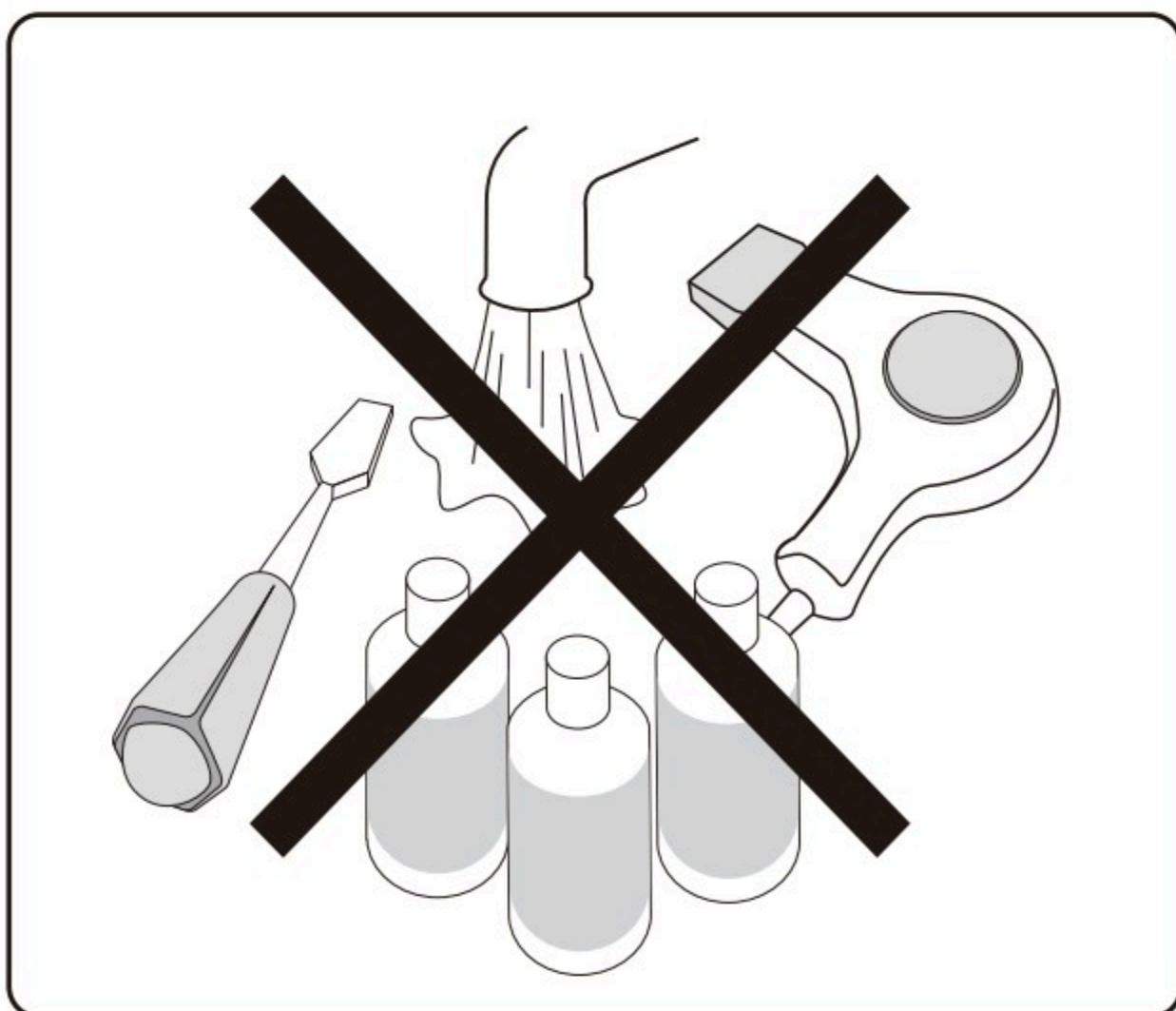

If the outer cover is torn or the mechanism is damaged,stop using the chair and contact us for assistance.