

# *MasterDrive* Duo



USER MANUAL | OG8900



# Hello.

Congratulations on purchasing your new Ogawa Master Drive Duo.

At Ogawa we understand every body is different and have carefully designed on our massage chair with that in mind. But enough about us, this is about you. Learning how to use your new chair is simple (we designed it that way).

So let's get started.

## We Can Help.

Our team will respond quickly to help you solve any issues

**1.877.977.0656**

Need a deeper massage?  
Remove Softening Pad

- 1** Unzip
- 2** Fold Down
- 3** Remove Pad

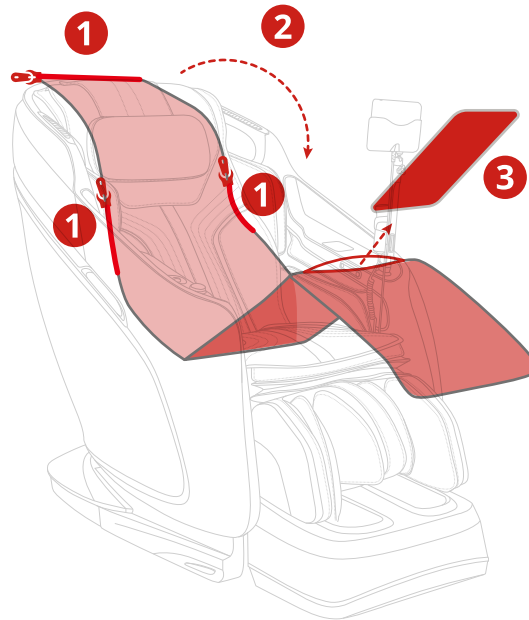

Scan QR Code to Visit Website



Scan QR Code for Operation Video



Scan QR Code for Service Support



For replacement parts and tech support, please call our service and warranty phone number, or visit [www.ogawaworldusa.com](http://www.ogawaworldusa.com)

# TABLE OF CONTENTS

 INTRO	Dimensions .....	3
	Contents .....	4
 CHAIR	Move & Clearance .....	5
	Components .....	6
	Massage Points .....	7
	Specifications .....	8
 MASSAGE	Interface .....	9-10
	Auto Massage .....	11-14
	Demo .....	15-16
	Manual Massage .....	17-19
	Custom Massage .....	20-28
	Chair Doctor .....	29-32
	Settings .....	33-42
	Voice Control .....	43-45
Auto Program Descriptions .....	46-54	
 CARE	Safety .....	55-57
	Grounding Instruction .....	58
	Troubleshooting .....	58
	Care and Storage .....	59
	Warranty .....	59-60

# DIMENSIONS

First, let's get your chair inside.

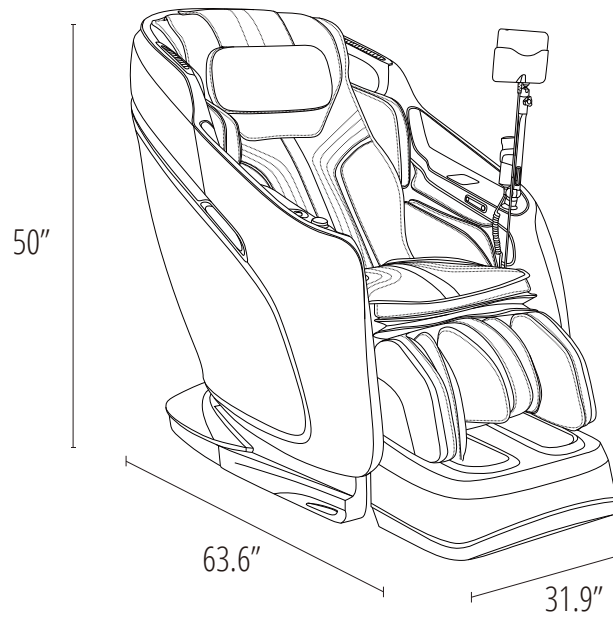

**Box 1**

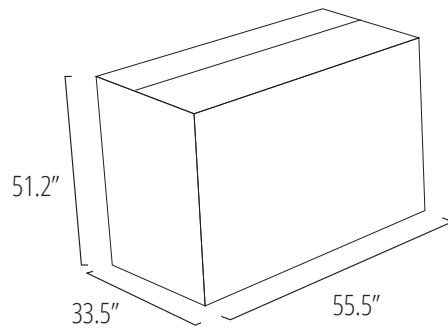

Base & Backrest

**Box 2**

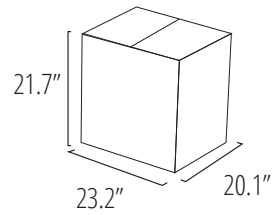

Footrest

# CONTENTS

Everything you need for a relaxing experience.



User Manual



Installation Manual



Warranty Postcard

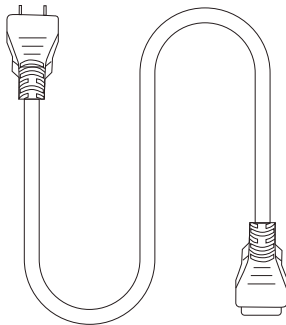

Power Cord

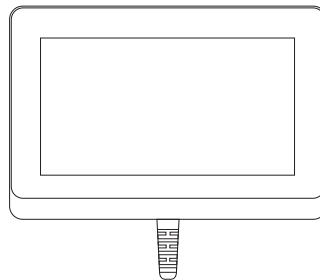

Wired Touch-Pad



OG8900 Massage Chair

# MOVE & CLEARANCE

A few simple steps to find the best place for your new chair.

## How to move

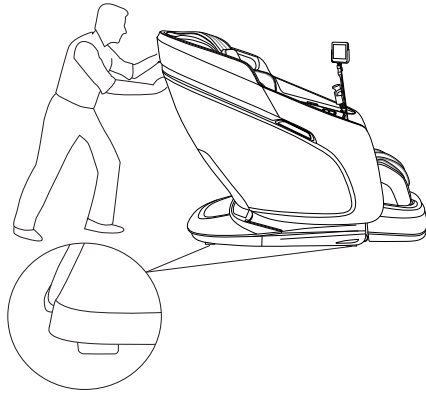

Move with a slight pull or push  
Caution: If you roll the chair on wood floor, marks may be left

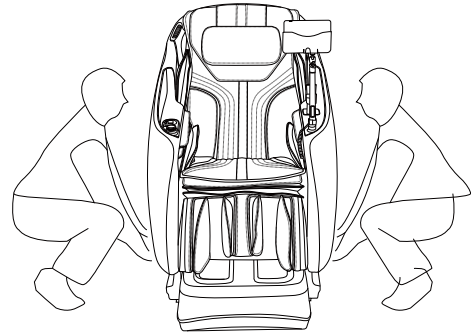

Two people are needed to lift the chair

## Clearance

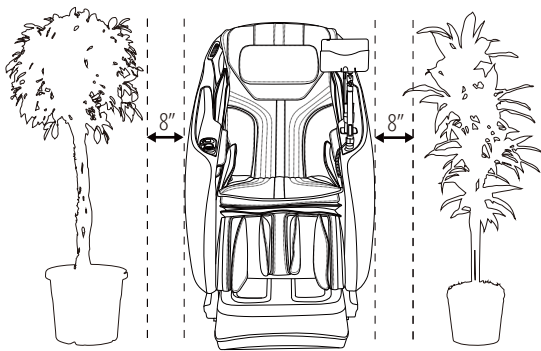

Reserve space on the left and right

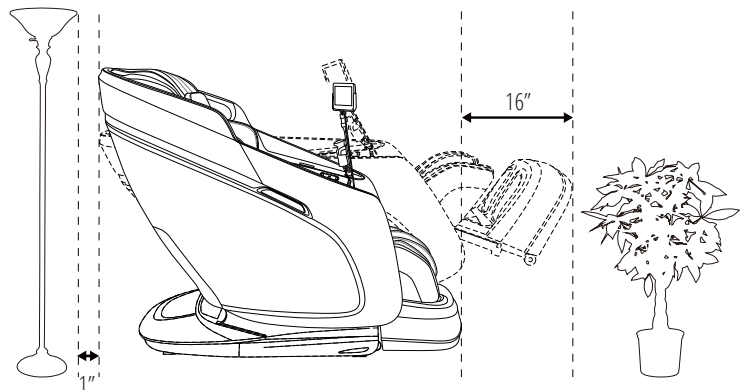

Reserve space on the front and back

# CHAIR COMPONENTS

Some of your chair's most important features.

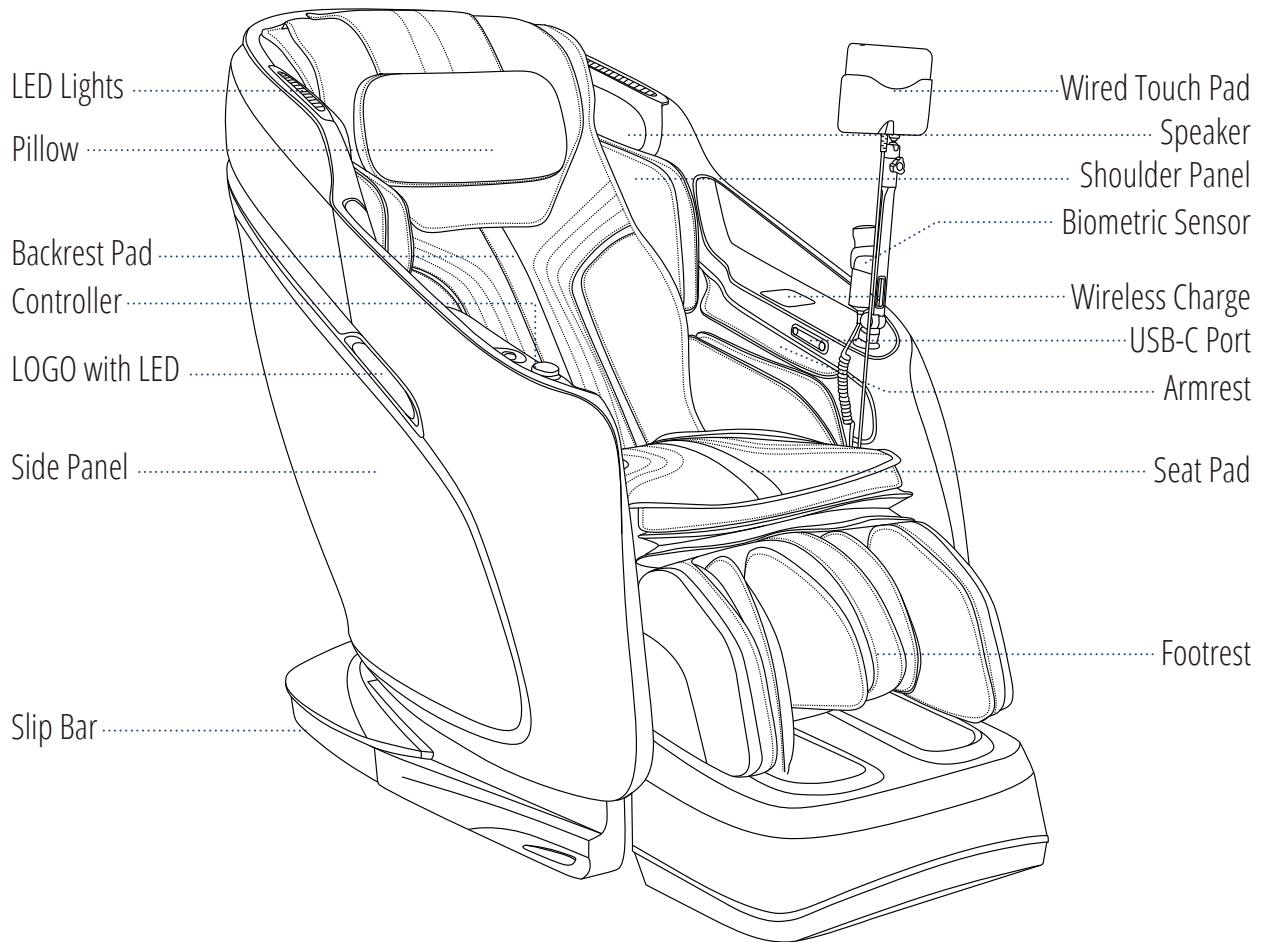

Note: The speaker will only operate when the massage chair is in operation



To play music using your massage chair's speakers please connect your smartphone, tablet, or other electronic device to your chair using bluetooth. Note that the code to connect the bluetooth is "Ogawa Master Drive Duo".



# MASSAGE POINTS

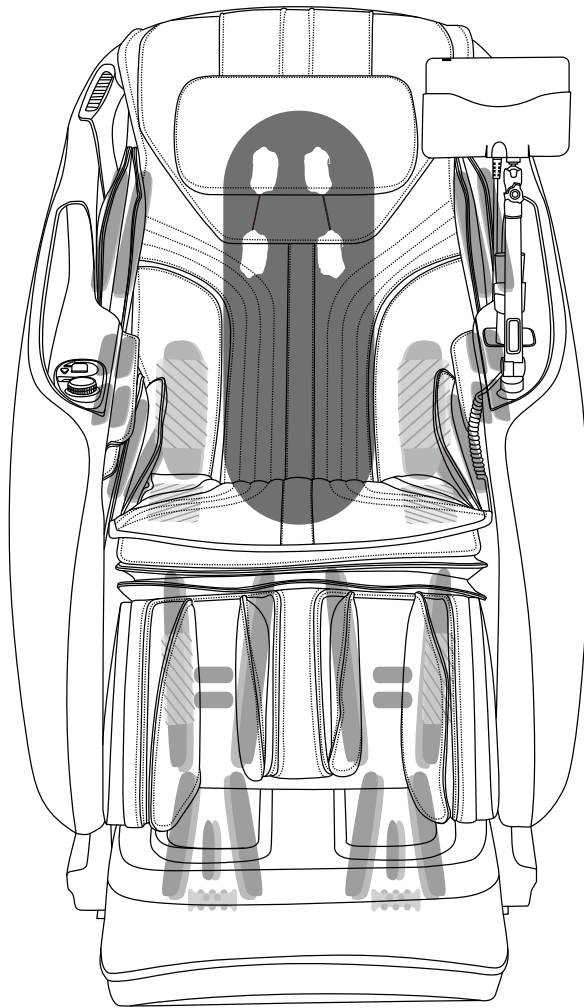

22 Air Bags  
2 Heat Pads On Lumbar  
2 Heat Pads On Seat

10 Air Bags  
2 Heat Pads On Leg  
Foot Rollers with Calf  
Kneading Massage

● Back Massage Mode

● Air Bag

●●● Roller

● Heating Pads

# CHAIR SPECIFICATIONS

A few important facts about your massage chair.



## Model No.

OG8900/ Master Drive Duo



## Massage Time

5 to 30 minutes

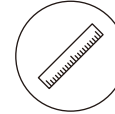

## Dimensions (L x W x H)

Chair dimensions: 63.6" x 31.9" x 50"  
Reclined dimensions: 73.7" x 31.9" x 41.5"



## Shipping Weight

Gross weight: 315.5 lbs  
Net weight: 273.6 lbs

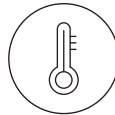

## Usage Condition

Environment temperature: 10°C-40°C  
Contrasting humidity: 30-85RH

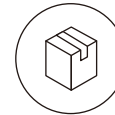

## Storage Condition

Storage temperature: -20°C-60°C  
Storage humidity level: 30-85RH



## Rated Current

2.1 A



## Rated Voltage

110 - 120 V



## Rated Frequency

60 Hz



## Power of Speakers

14 W (2 sides)



## Length of Wiring

Controller wiring: 27.6"  
Power supply wiring: 70.9"



## Safety Feature

Equipped with child safety lock,  
leg rest and backrest safety sensor,  
and overheating and power surge detectors

# WIRED TOUCH PAD INTERFACE

We have designed your massage chair's tablet controller with a user-friendly interface to make using your chair even easier.

## Home Screen

Bluetooth Switch    Voice Control Switch    Demo    Auto Massage

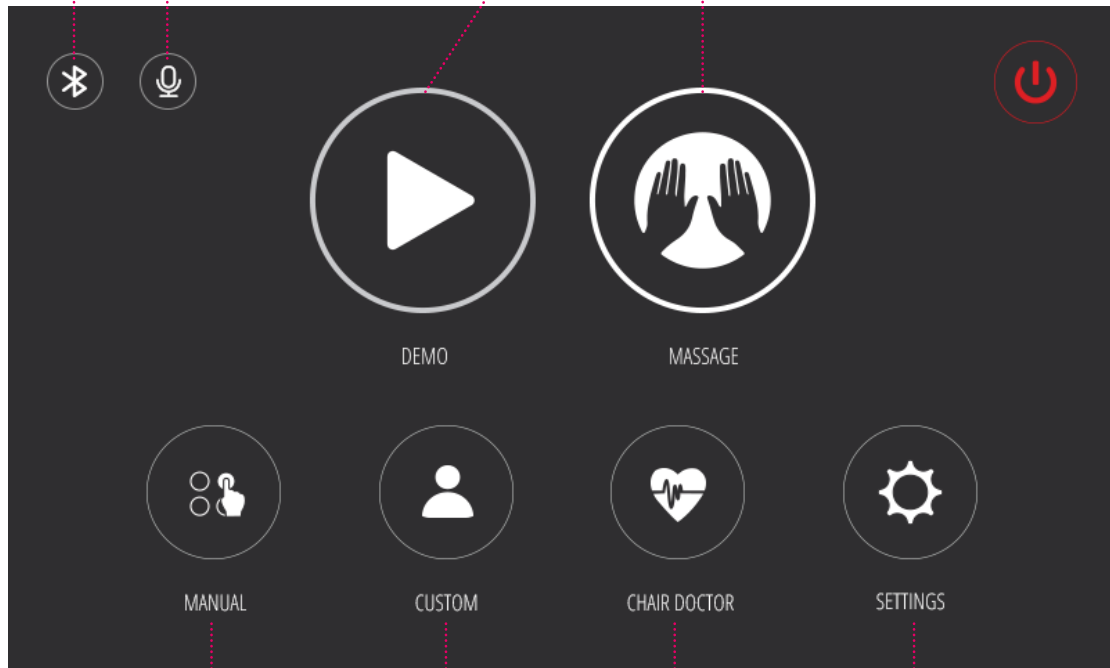

Manual  
Massage

Custom  
Massage

Chair  
Doctor

Settings

## Massage Controls

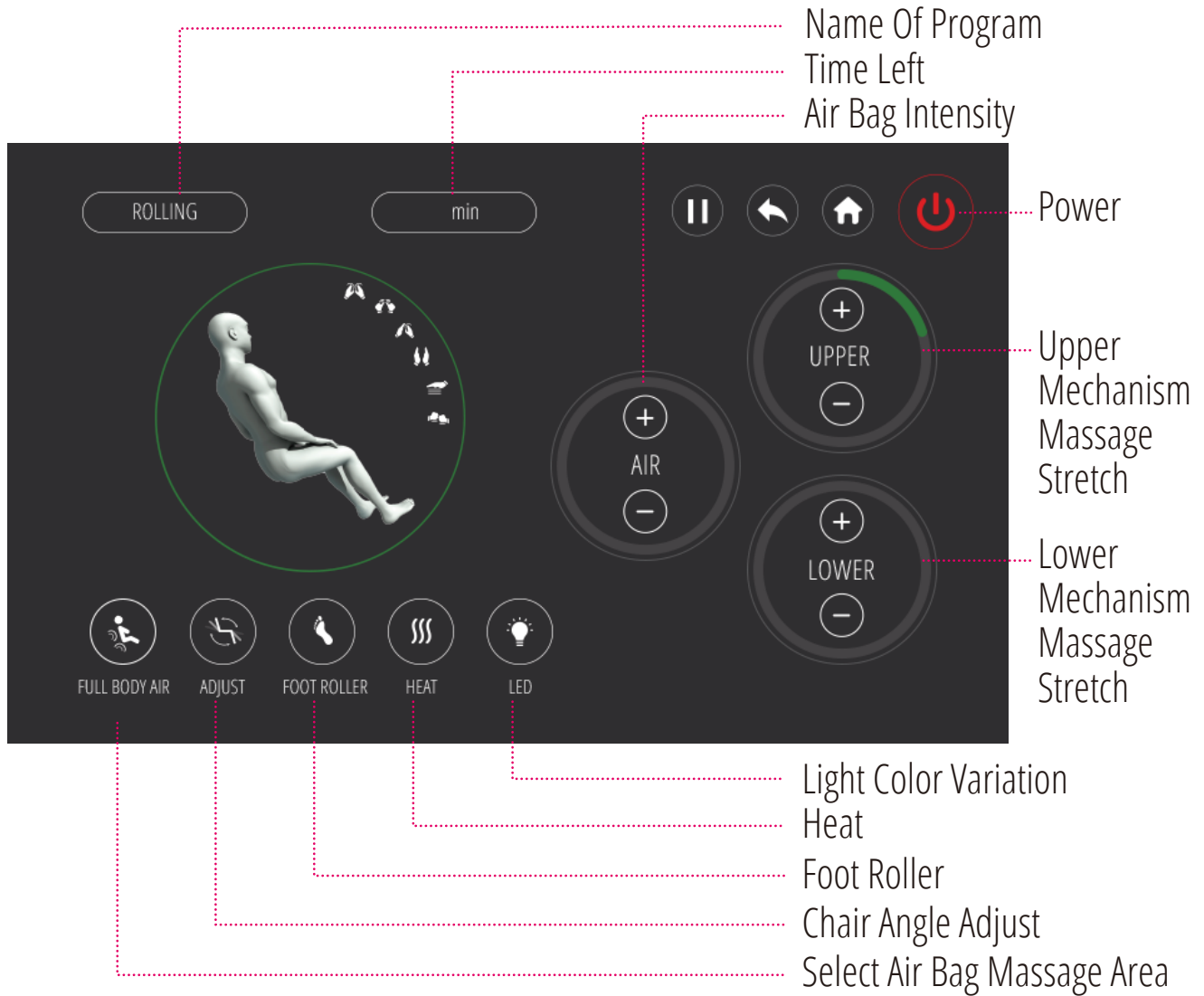

# AUTO MESSAGE

We have designed your chair with multiple message options for your changing needs. Follow these simple instructions to begin a new auto message.

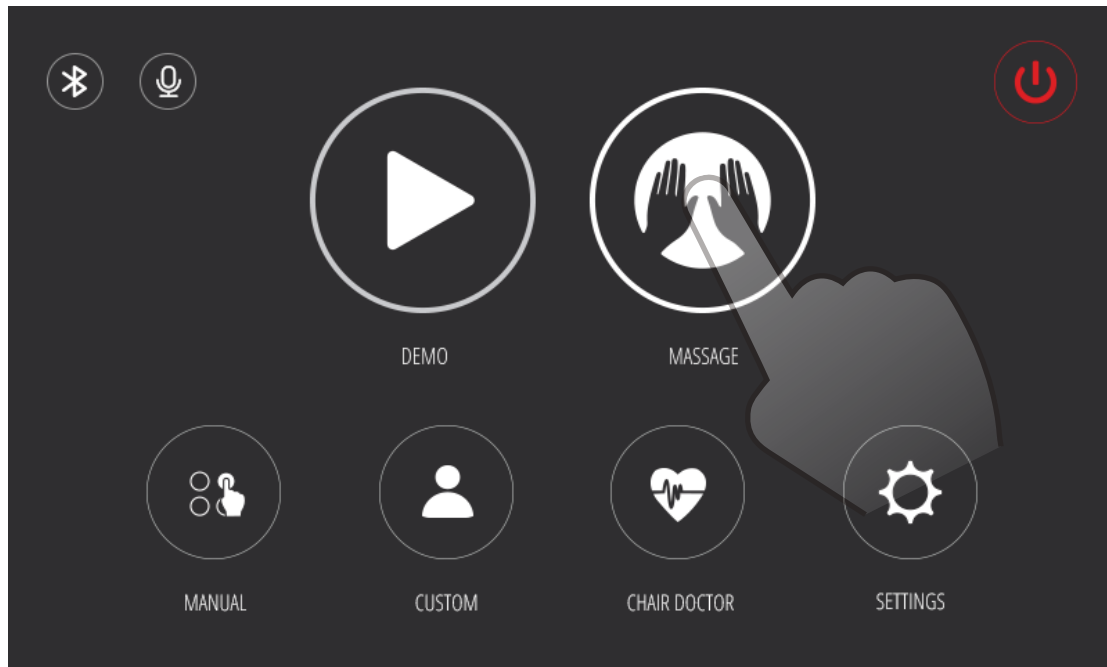

Choose the "Message" icon to select your auto massage program

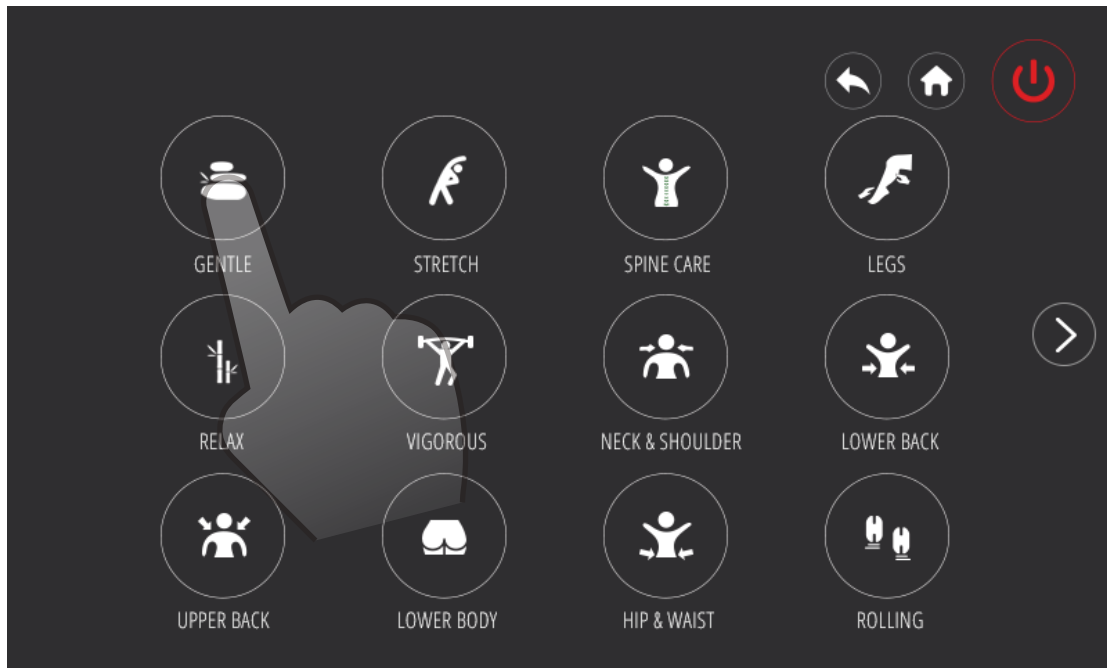

Choose 1 of our 25 auto massages

(Demo, Gentle, Stretch, Spine Care, Legs, Relax, Vigorous, Neck&Shoulder, Lower Back, Upper Back, Lower Body, Hip&Waist, Rolling, Swedish, Thai, Japanese, Chinese, Balinese, Morning, Night, AI Design, Post Workout, Recharge, Yoga Stretch, Deep Tissue)

## Auto Massage Interface

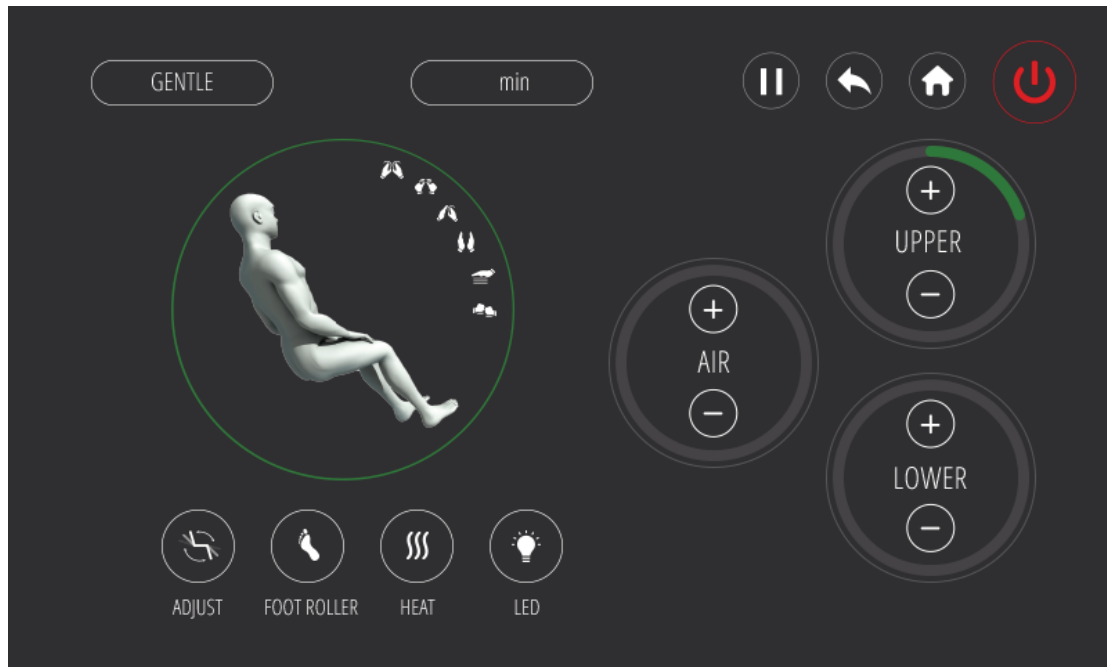

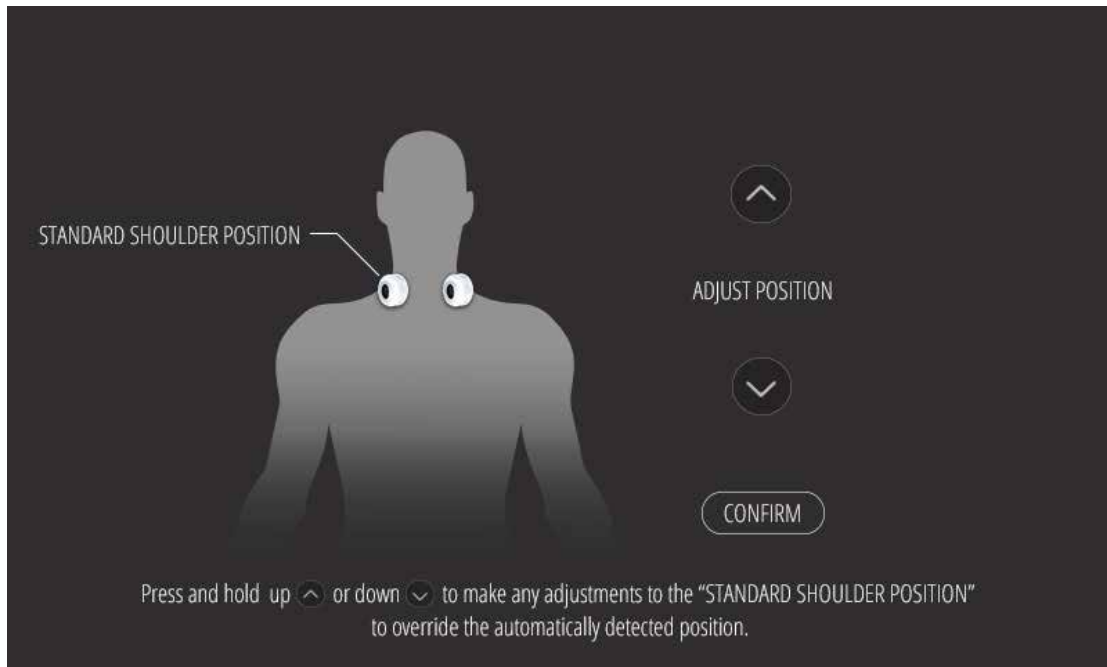

Using the arrows, you can adjust the standard shoulder position



# DEMO

In order to allow you to quickly understand your massage chair, we have created a demo program.

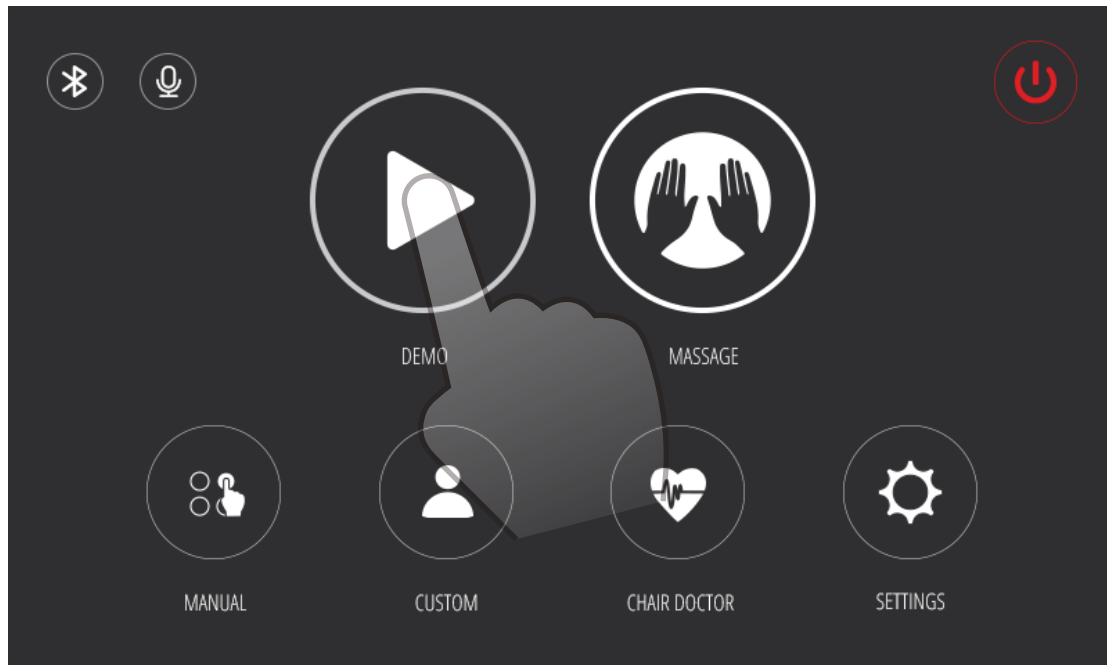

Choose the "Demo" icon to start the Demo program

## Demo Interface

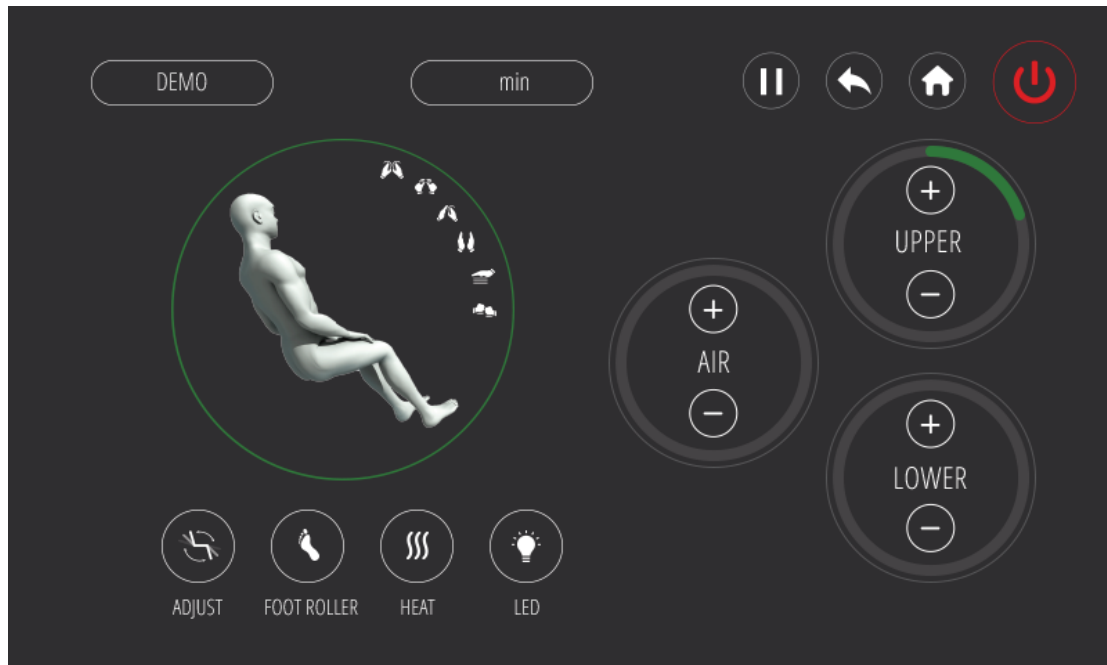

# MANUAL MESSAGE

Here you can choose a manual message or a compression message program.

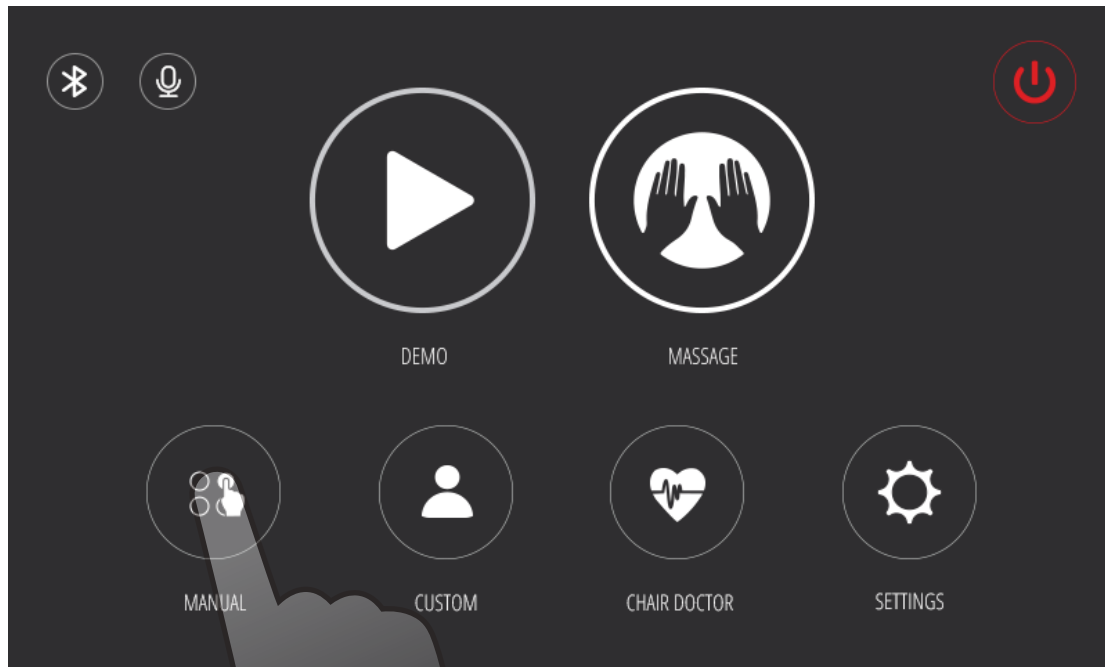

Choose the "Manual" icon to begin manual massage

## Massage Action Interface

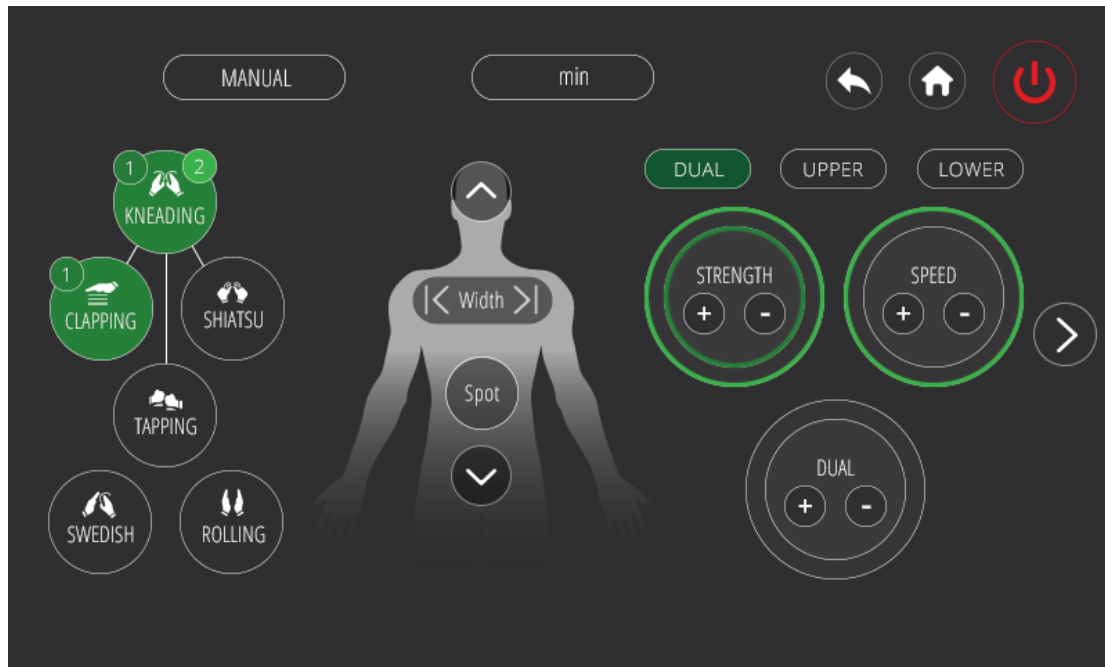

The kneading massage can be combined with tapping, clapping or shiatsu massage

# Massage Action Interface

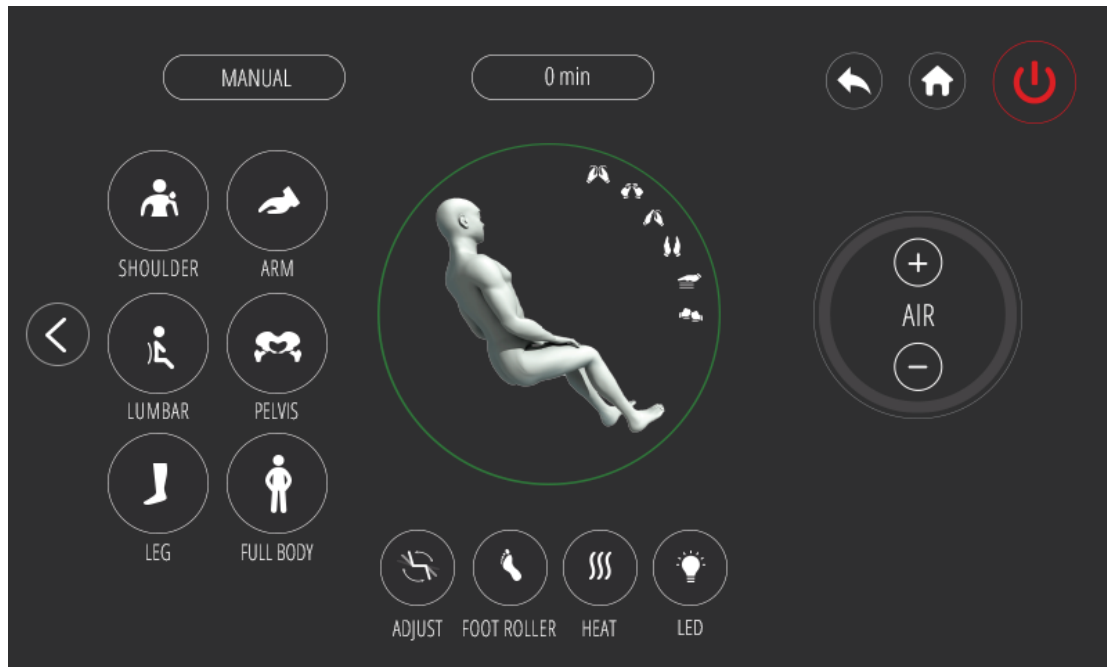

# CUSTOM MESSAGE

Every body is different. That's why we've given you the option to customize your message to meet your specific needs. Follow these simple instructions to create a new custom message. You can create up to three custom programs. To delete a custom message program, press and hold the icon of the message you want to delete and choose the "X".

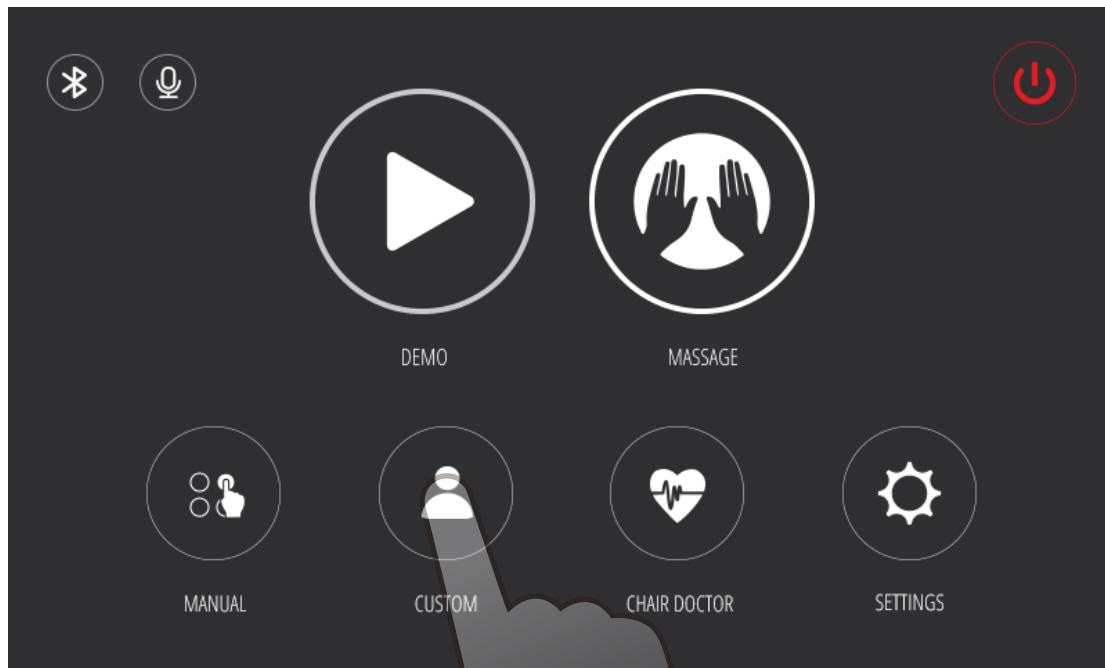

Choose the "Custom" icon to begin creating your message program

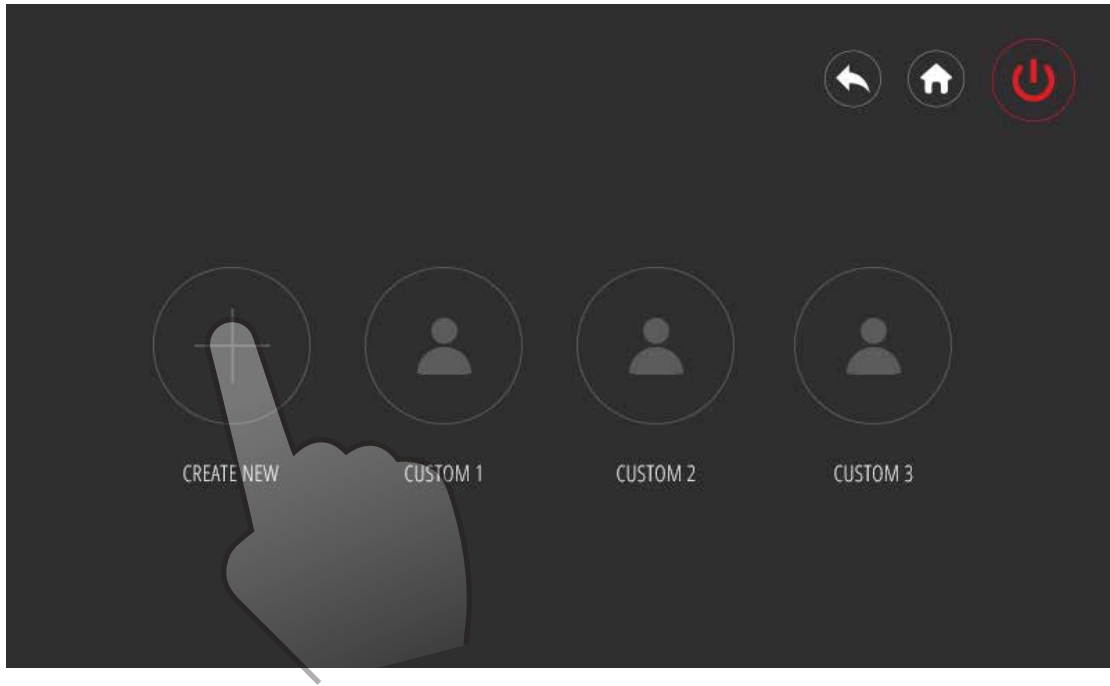

Choose the "Create New" icon

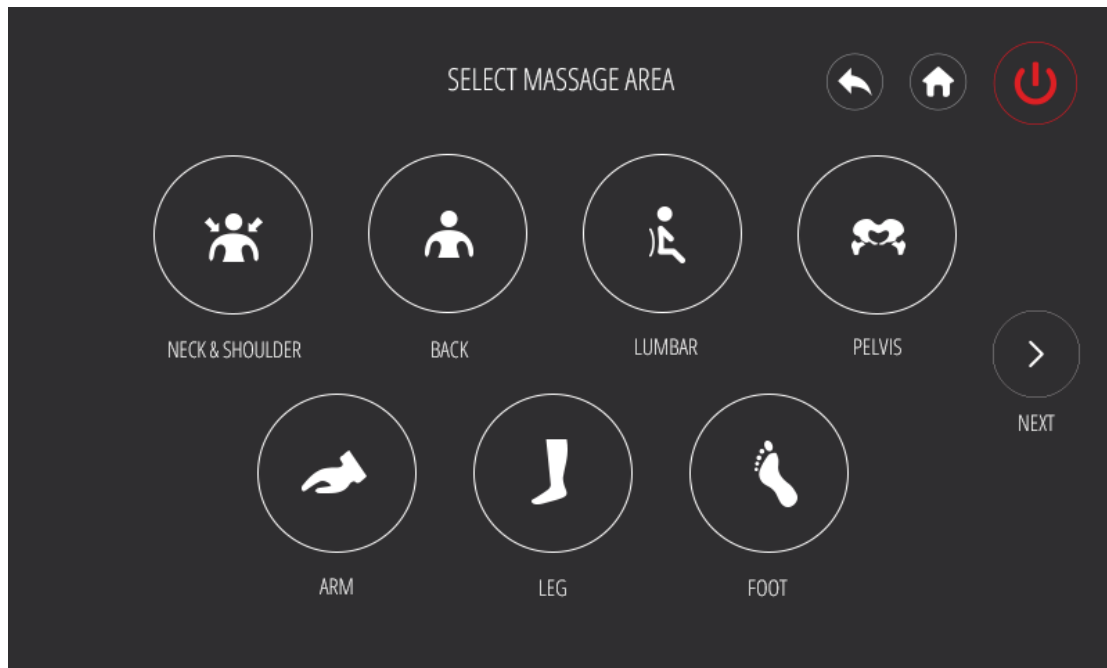

Select the massage area that you prefer





Select which massage action you would like the upper mechanism to perform - the kneading, tapping, clapping, and shiatsu massages can be combined with swedish or rolling

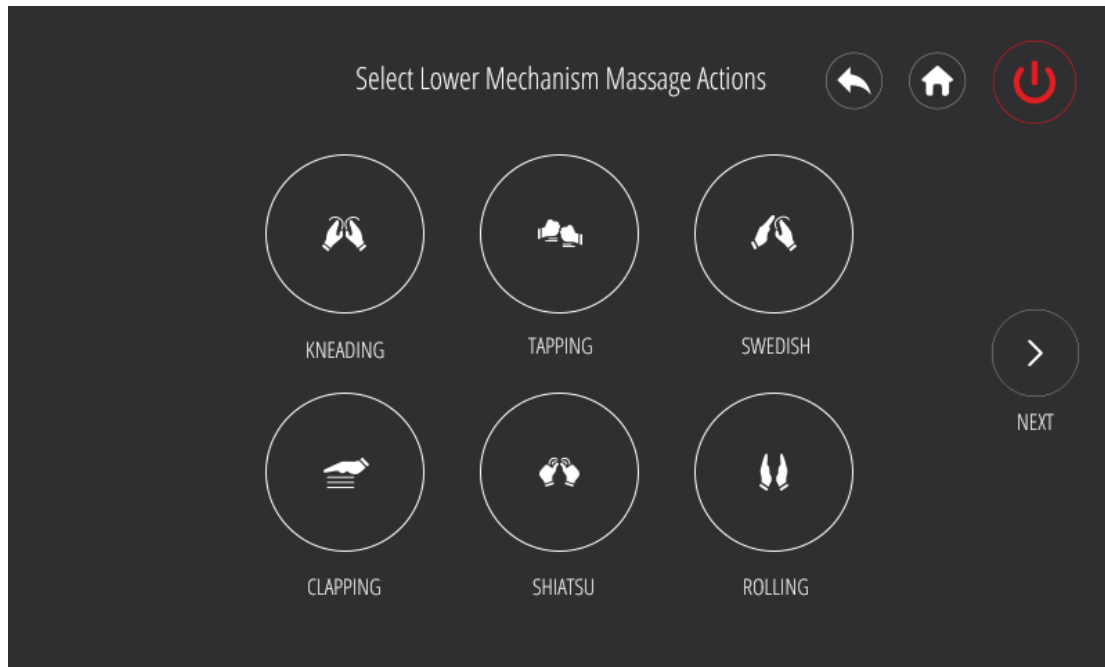

Select which massage action you would like the lower mechanism to perform - the kneading, tapping, clapping, and shiatsu massages can be combined with swedish or rolling

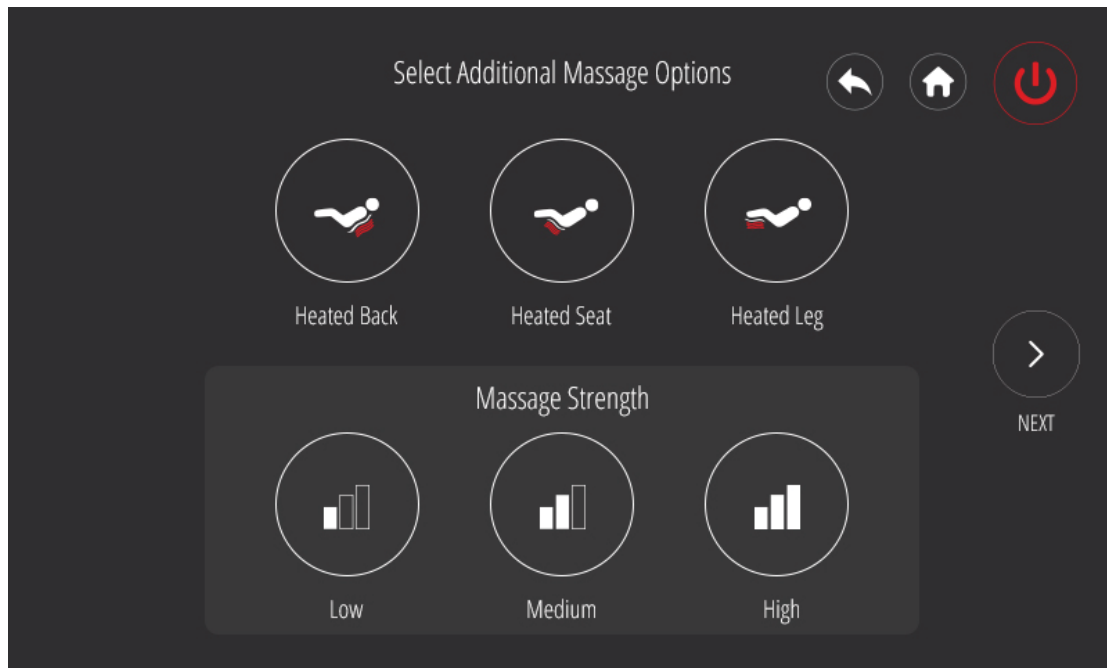

Select the heat areas and massage strength that you prefer

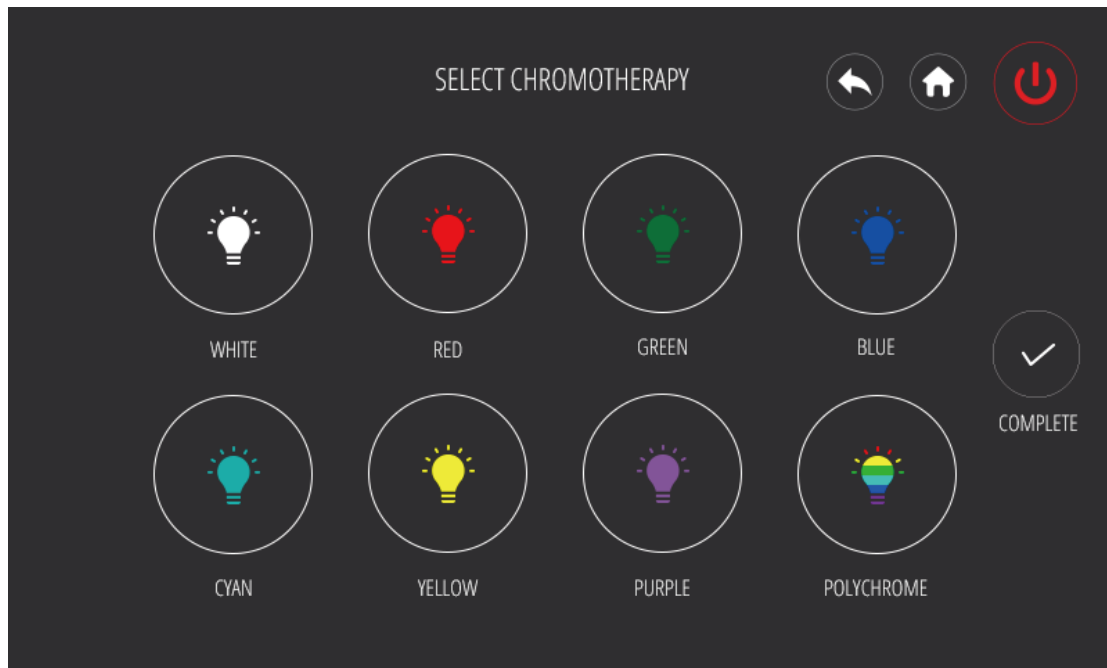

Select the chromotherapy light pattern that you prefer

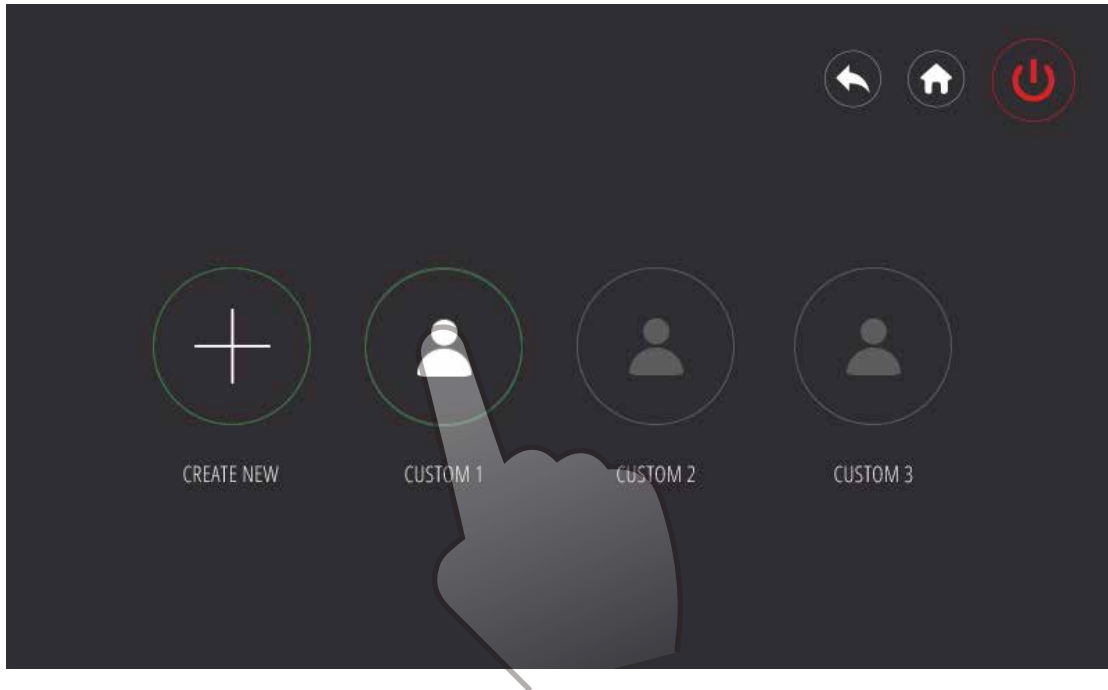

Choose the "Custom 1" icon to start your program

## Custom Interface

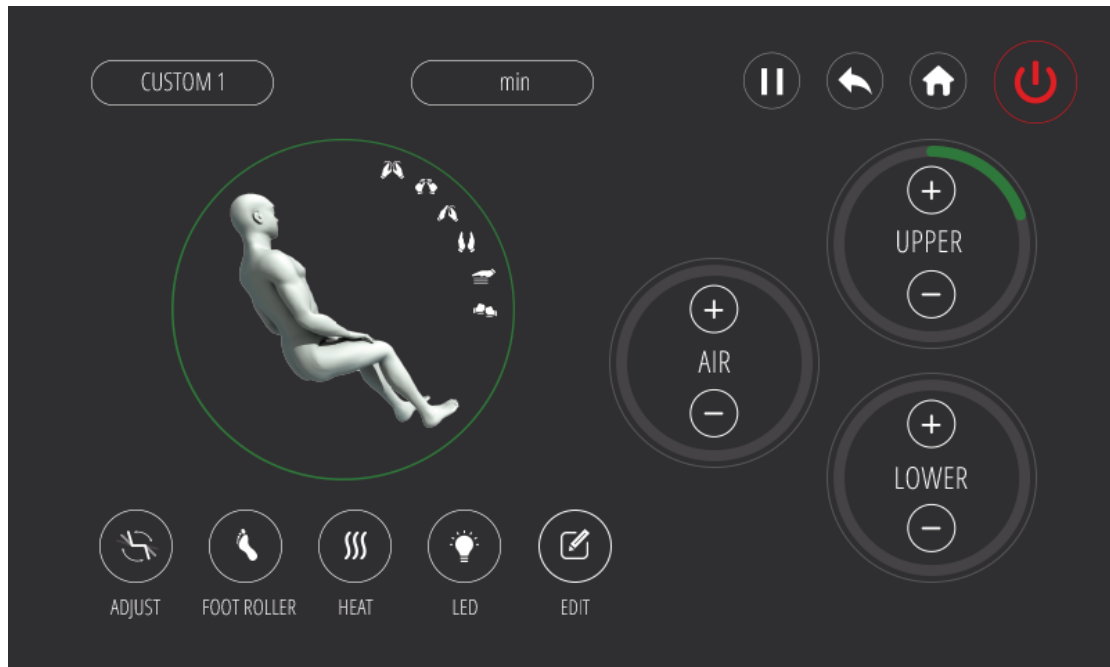

# CHAIR DOCTOR

An innovative tool that diagnoses your body tension, SpO2 (oxygen saturation), and heart rate, to treat your unique body.

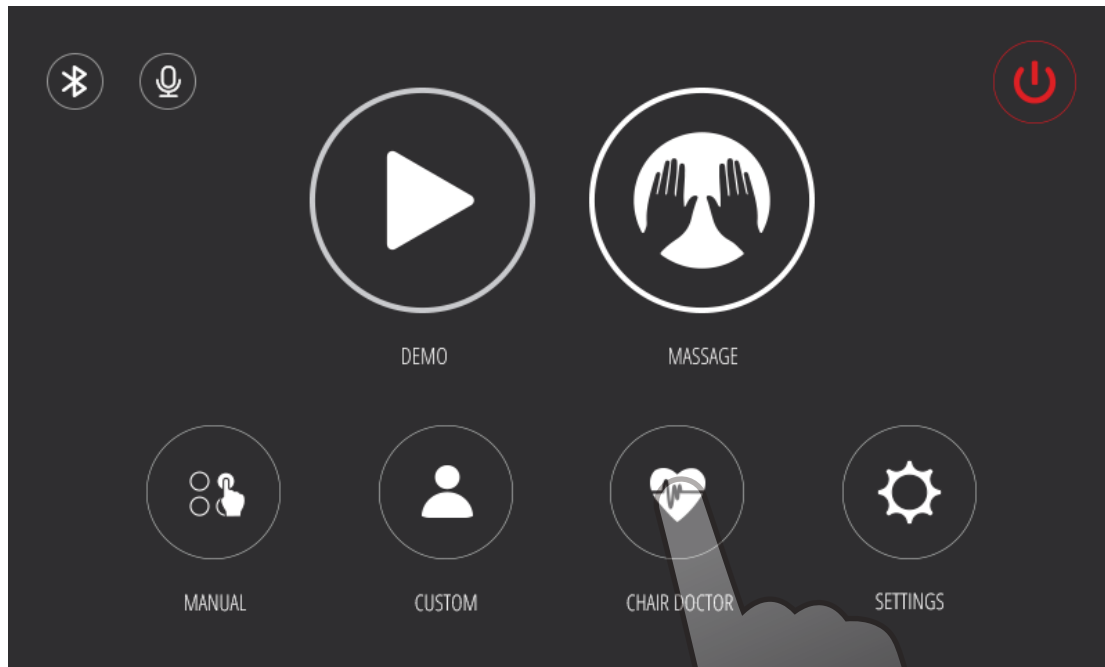

Choose the "Chair Doctor" button to take you to the chair doctor page

## Chair Doctor Interface 1

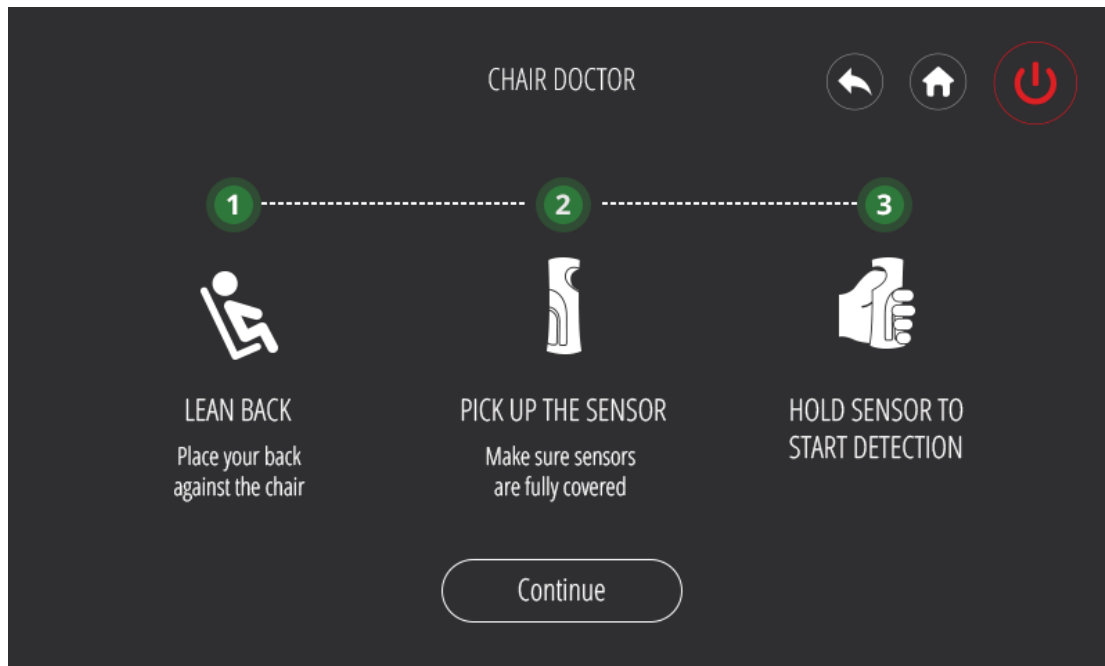



## Chair Doctor Interface 2

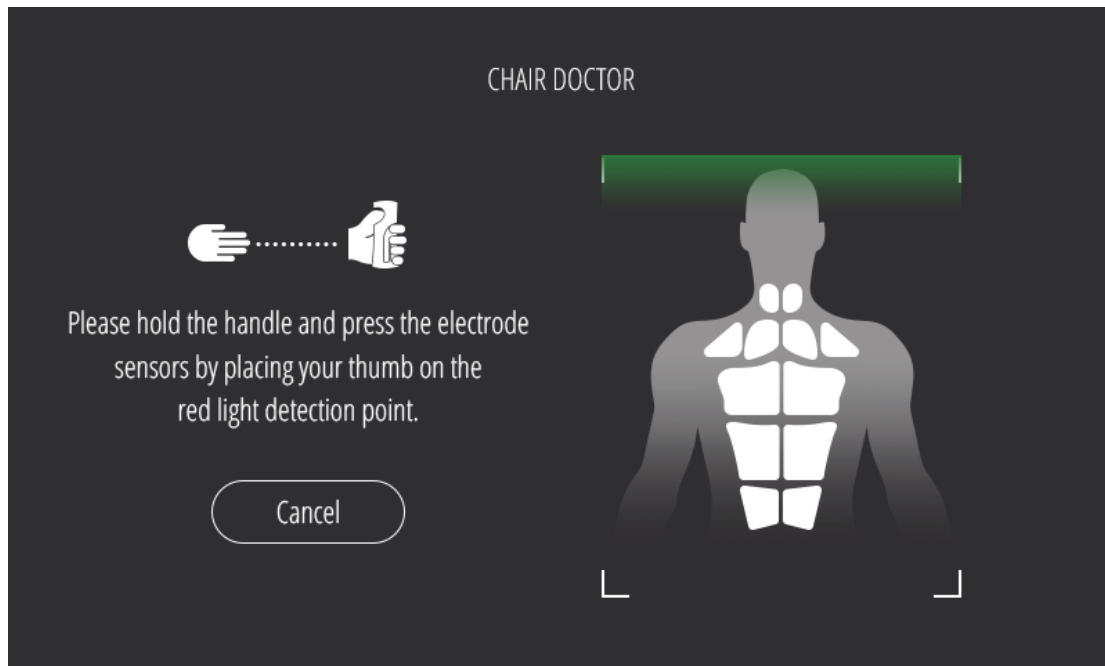

## Chair Doctor Interface 3

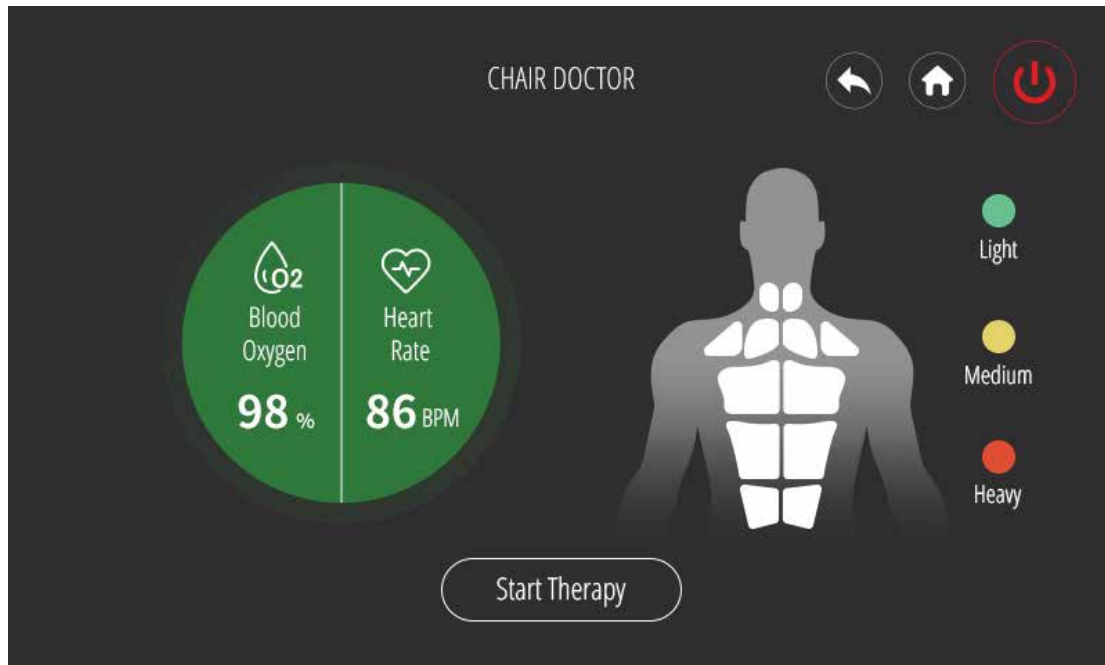

# SETTINGS

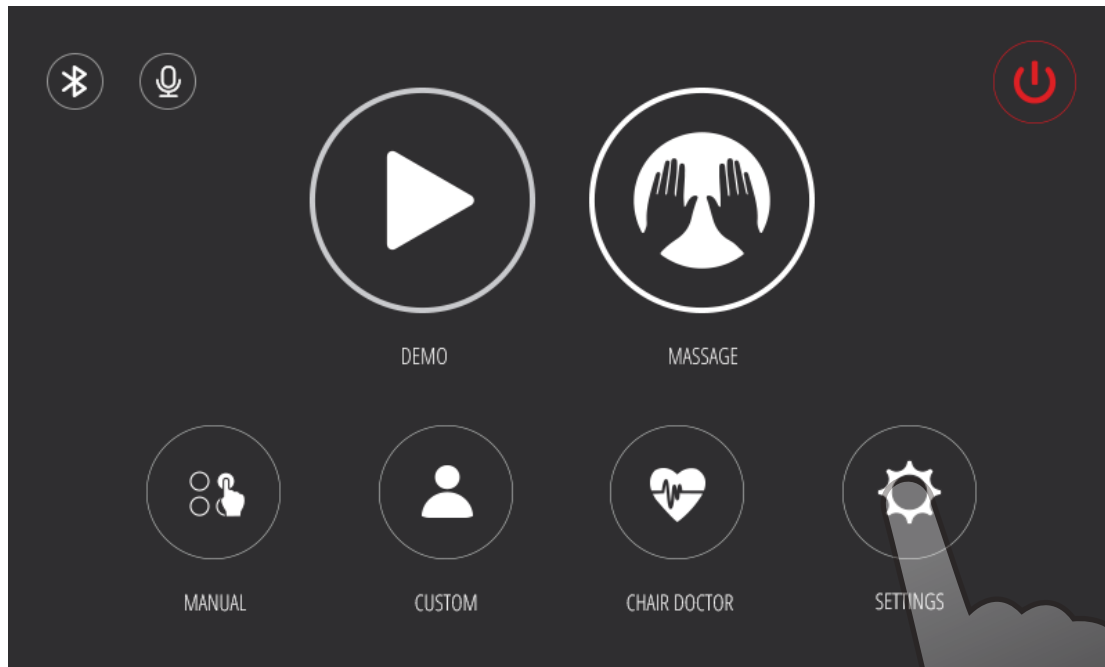

Choose the “Settings” button to take you to the settings page

## Settings Interface

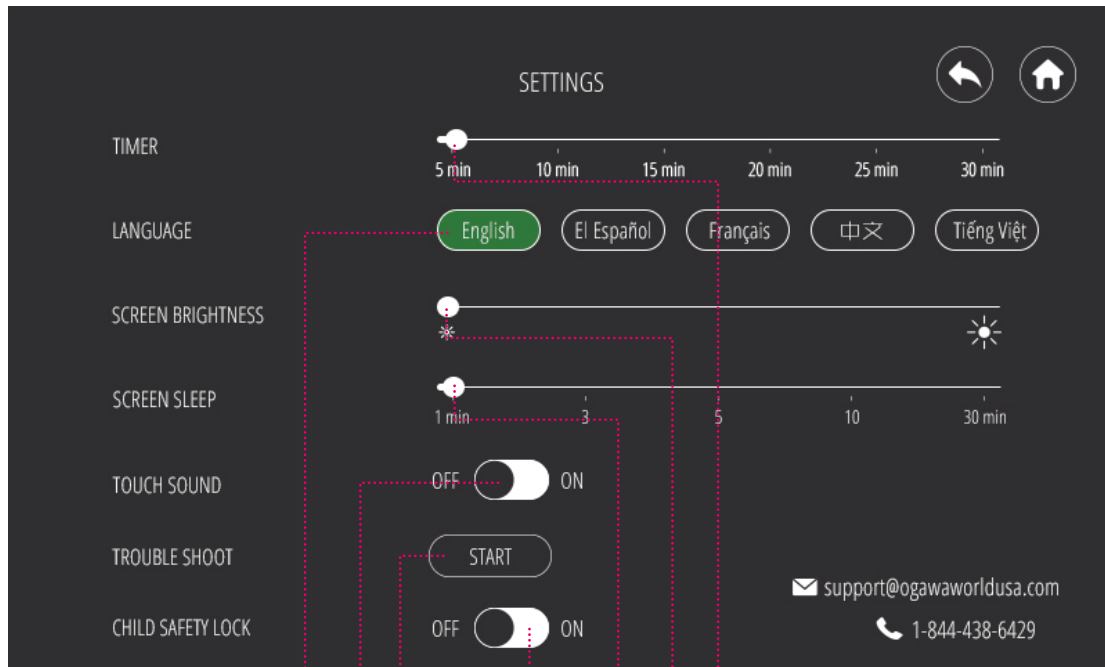

Language Adjust

Touch Sound On / Off

Trouble Shoot Detecting Button

Child Safety Lock On / Off

Massage Time Adjust

Screen Brightness Adjust

Screen Sleep Time Adjust

## Trouble Shooting



If your chair has any trouble, press the Trouble Shoot "Start" button for the chair to automatically detect problem areas. Use the error code provided when contacting our customer service team

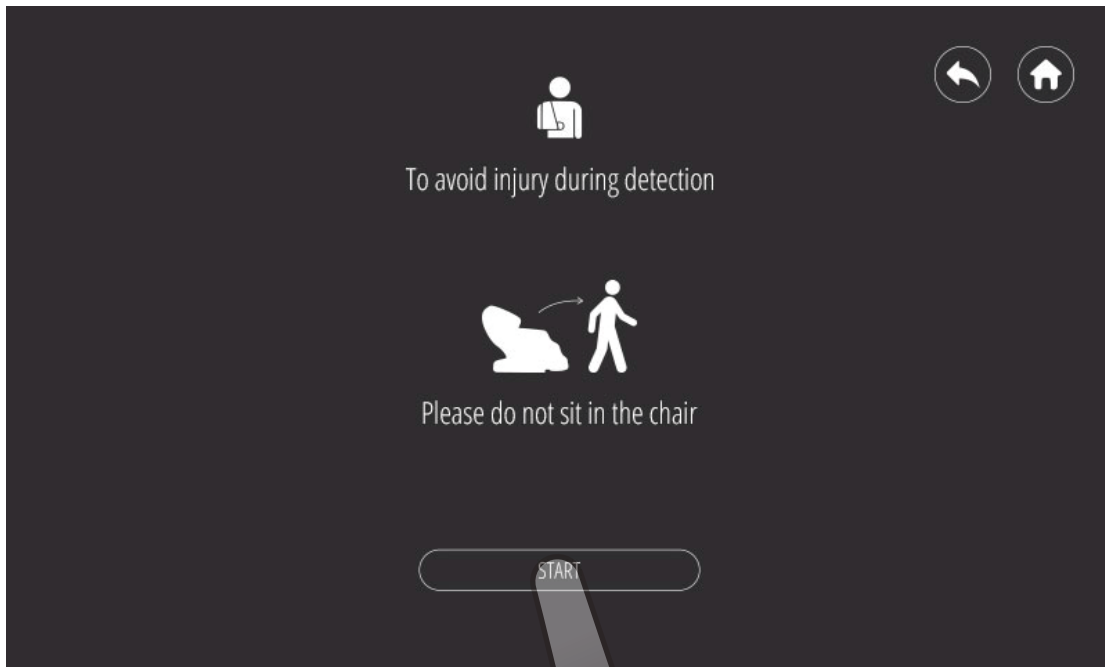

Choose "Start" button and make sure the chair is not occupied during chair detection

Scanning may take up to 70 seconds



MALFUNCTION  
DETECTION

Your chair is detecting possible malfunctions, please wait for the detection result



You can use your detection code when contacting the Ogawa customer service team about your chair's problems



## Child Safety Lock

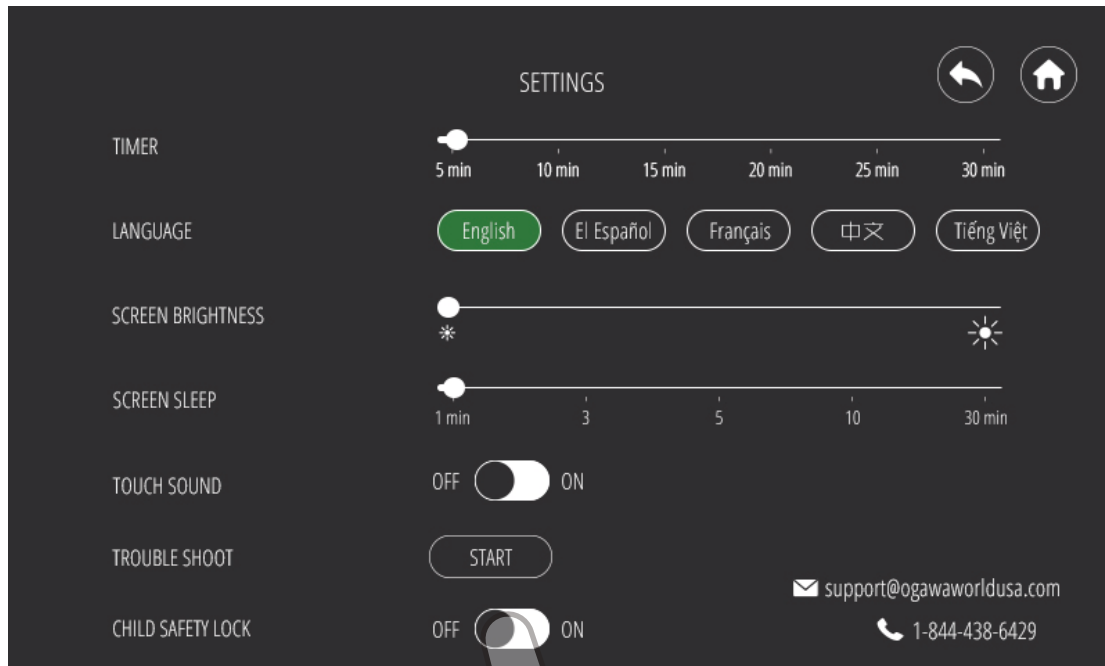

To disable this chair for child safety, set the Child Safety Lock setting to "ON"

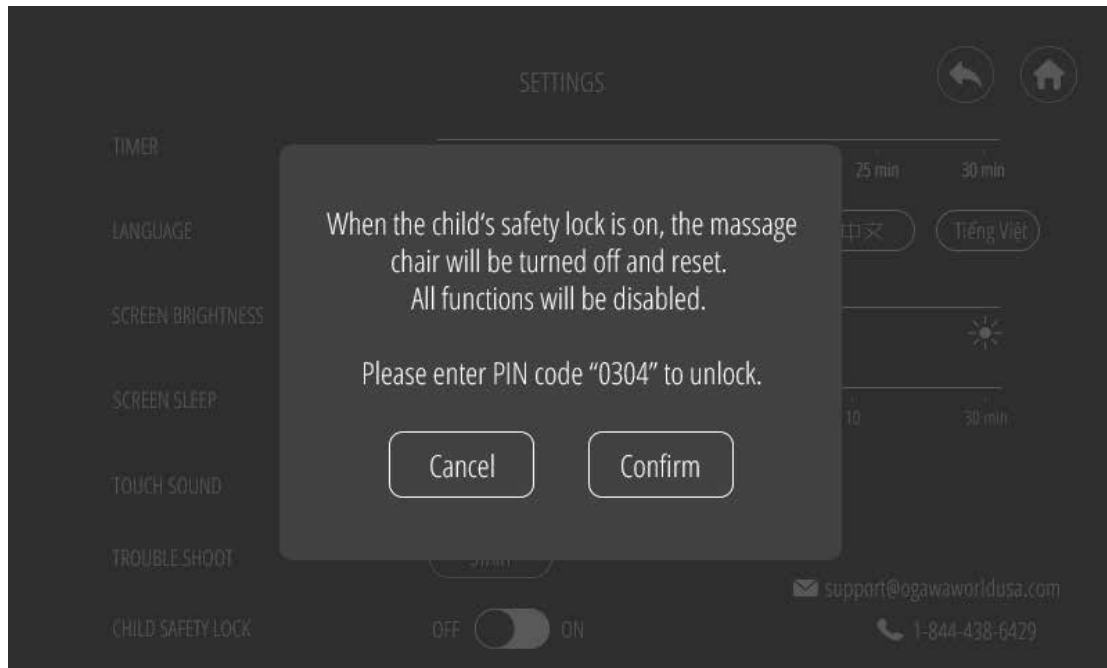

When the child safety lock is on, the massage chair will be turned off and reset.  
All functions will be disabled. Please enter pin code "0304" to unlock

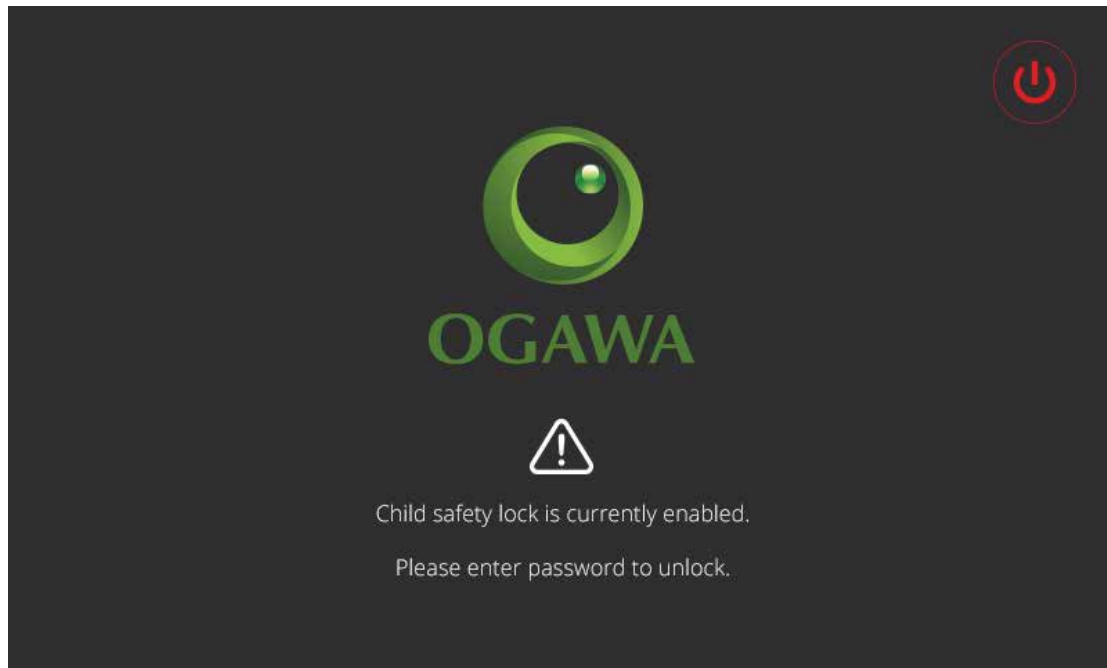

When the child safety lock is enabled, this screen will appear at startup.  
Please click anywhere on the screen to begin the unlocking process



Please enter "0304" to unlock your massage chair

# VOICE CONTROL

This chair supports a voice control function. To activate, turn on the voice control switch, which is on the home page. The user will first need to speak the wake-up word, and then speak the voice command for the corresponding function of the chair. After receiving the voice command from the user, the chair will answer and perform the corresponding function.

Chair Function		Voice Command	Massage Chair Feedback
Massage chair wake up / Pause / Power off	Wake up word	Hey Ogawa	Ogawa is here
		Start massage chair	
		Hi massage chair	
	Power on	Power on	Chair is powering on
		Turn on	
	Power off	Power off	Sure, I hope you enjoyed your massage
		Turn off	
	Pause	Pause massage	Okay, pause the massage
Stop massage			
Continue the massage program from before the pause	Continue massage	Okay, continue the massage	
	Keep going		
Chair position adjustment	Lower legs and raise back	Lift chair	All right, right away / I have reached the maximum angle
	Raise legs and lower back	Recline chair	
	Zero gravity on	Zero gravity on	All right, right away / I have reached the zero gravity position
		Put me in zero gravity	
	Zero gravity off / Home position	Stop zero gravity	All right, right away / I have reached the home position
		Get me out	
		Zero gravity off	
		Home position	

Chair Function		Voice Command	Massage Chair Feedback
Massage intensity adjustment	Increased intensity / Turn up strength (+1/command)	Harder massage	OK, use more force
		Deeper massage	
		Stronger massage	
	Weakened intensity / Turn down strength (-1/command)	Be gentle	OK, use lighter force
		Lighter massage	
		Weaker massage	
Voice volume adjustment	Volume increase	Louder	Ok. Increasing the volume / Sorry, I can't go any louder
		Increase the volume	
	Volume reduction	Too loud	Ok. Decreasing the volume / I am at the lowest volume
		Decrease the volume	
Automatic recommendation massage	Random call program	Begin massage	Ok, you have started the.... program
		Give me a massage	
		Change the program	
		Change massage	
		I need a massage	
Heating function	Heat on	Heat on	All right, turn on the heat
	Heat off	Heat off	All right, turn off the heat
Footrest adjustment	Extend footrest	Extend footrest	All right, right away / I have reached the limit position
		Longer footrest	
		Bring out footrest	
	Retract footrest	Shorter footrest	
		Retract footrest	
		Bring in footrest	
	Re-detect footrest length	Adjust the footrest	All right, right away

Chair Function		Voice Command	Massage Chair Feedback
Start an automatic message program	Start an automatic message program	Relax program	Ok, you have started the Relax program
		Gentle program	Ok, you have started the Gentle program
		Stretch program	Ok, you have started the Stretch program
		Demo program	Ok, you have started the Demo program
		Vigorous program	Ok, you have started the Vigorous program
		Spine Care program	Ok, you have started the Spine Care program
		Rolling program	Ok, you have started the Rolling program
		Neck&Shoulder program	Ok, you have started the Neck&Shoulder program
		Lower Back program	Ok, you have started the Lower Back program
		Upper Back program	Ok, you have started the Upper Back program
		Lower Body program	Ok, you have started the Lower Body program
		Hip&Waist program	Ok, you have started the Hip&Waist program
		Recharge program	Ok, you have started the Recharge program
		Post Workout program	Ok, you have started the Post Workout program
		Balinese program	Ok, you have started the Balinese program
		Swedish program	Ok, you have started the Swedish program
		Thai program	Ok, you have started the Thai program
		Chinese program	Ok, you have started the Chinese program
		Japanese program	Ok, you have started the Japanese program
		Legs program	Ok, you have started the Legs program
		Morning program	Ok, you have started the Morning program
		Night program	Ok, you have started the Night program
		AI Design program	Ok, you have started the AI Design program
Deep Tissue program	Ok, you have started the Deep Tissue program		
Yoga Stretch program	Ok, you have started the Yoga Stretch program		

# AUTO PROGRAM DESCRIPTIONS

Let's dig a little deeper and discover the details of our pre-programmed massages.

## Demo



A 5 minute whole body massage for those on the go.

## FOCUS AREAS

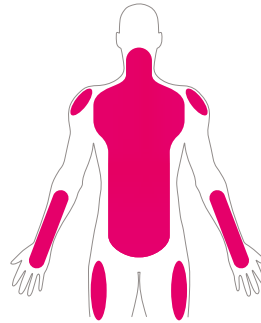

## INTENSITY



## FOCUS TECHNIQUES



KNEADING ROLLING TAPPING

## Gentle



A program designed to provide a quiet, gentle massage that is good for beginners or those that prefer a soft touch.

## FOCUS AREAS

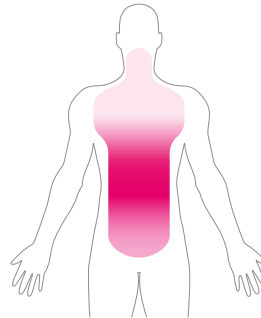

## INTENSITY



## FOCUS TECHNIQUES



KNEADING ROLLING

## Stretch



This massage will stretch your legs and back with a combination of gentle tapping, rolling, and air compression.

## FOCUS AREAS

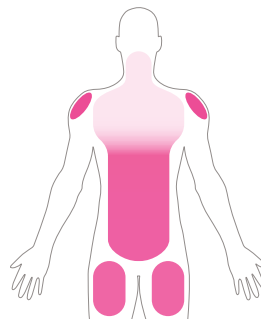

## INTENSITY



## FOCUS TECHNIQUES



KNEADING TAPPING



## Spine Care



This program provides a deep tissue massage that relaxes the spine.

### FOCUS AREAS

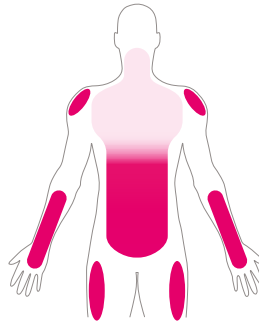

### INTENSITY



### FOCUS TECHNIQUES



SHIATSU SWEDISH

## Legs



This program will focus on your leg muscles.

### FOCUS AREAS

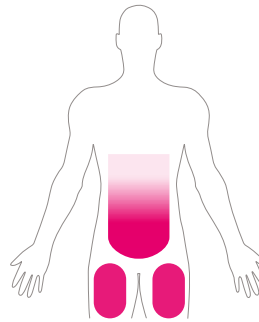

### INTENSITY



### FOCUS TECHNIQUES



SWEDISH CLAPPING

## Relax



A program designed to provide a mild massage that is great for deep relaxation, best used before going to sleep.

### FOCUS AREAS

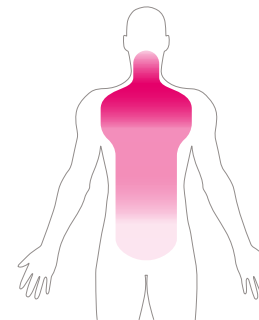

### INTENSITY



### FOCUS TECHNIQUES



KNEADING SWEDISH

## Vigorous



This massage will combine vigorous tapping on your lower back and an air massage focused on your thighs and legs.

### FOCUS AREAS

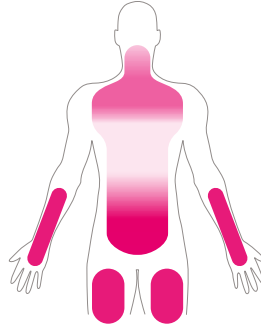

### INTENSITY



### FOCUS TECHNIQUES



TAPPING KNEADING

## Neck & Shoulder



This massage will focus on your shoulders and neck using a combination of kneading and shiatsu techniques.

### FOCUS AREAS

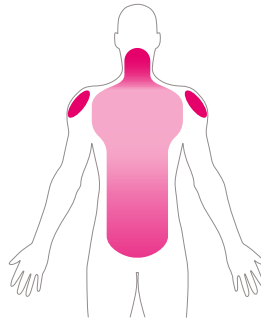

### INTENSITY



### FOCUS TECHNIQUES



KNEADING TAPPING

## Lower Back



This massage will focus on your lower back with a deep massage that includes air compression.

### FOCUS AREAS

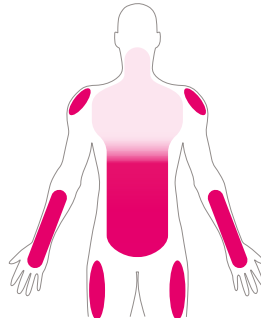

### INTENSITY



### FOCUS TECHNIQUES



TAPPING KNEADING

## Upper Back



This massage will focus on your neck, shoulders, and legs with a slow massage that incorporates soothing heat.

### FOCUS AREAS

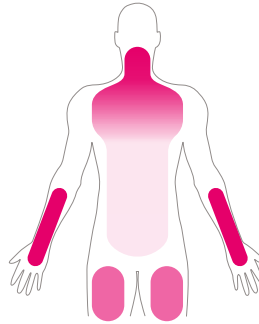

### INTENSITY



### FOCUS TECHNIQUES



KNEADING TAPPING SWEDISH

## Lower Body



This is a partial body program that focuses air compression and vibration on the lower body.

### FOCUS AREAS

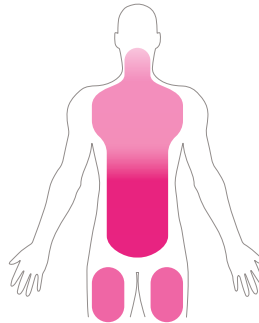

### INTENSITY



### FOCUS TECHNIQUES



KNEADING ROLLING

## Hip & Waist



A program that helps you relax your waist and hip muscles.

### FOCUS AREAS

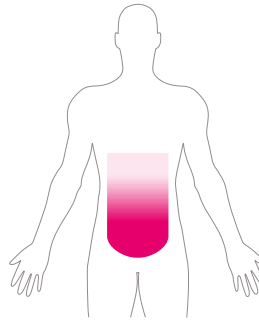

### INTENSITY



### FOCUS TECHNIQUES



CLAPPING TAPPING

## Rolling

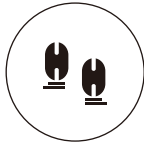

This program will massage from your neck down to your hips, using the ultra rolling technique.

### FOCUS AREAS

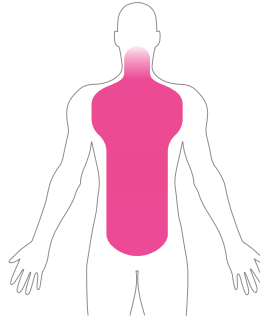

### INTENSITY



### FOCUS TECHNIQUES



ROLLING

## Swedish



This massage will focus on your neck down to glutes in the beginning then finish with a soothing rocking motion.

### FOCUS AREAS

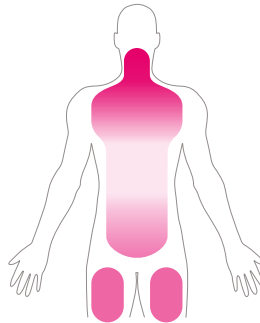

### INTENSITY



### FOCUS TECHNIQUES



KNEADING TAPPING

## Thai



This massage will focus on your mid back and upper shoulders with a deep tissue massage that will create an acupuncture effect.

### FOCUS AREAS

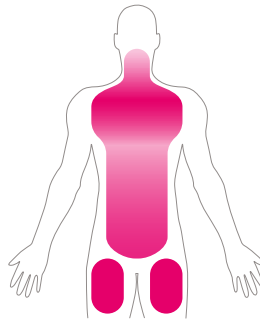

### INTENSITY



### FOCUS TECHNIQUES



KNEADING TAPPING

## Japanese



A program designed using Japanese-inspired techniques to improve your immune system, blood circulation, and aid in pain relief.

### FOCUS AREAS

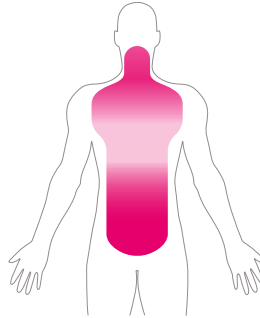

### INTENSITY



### FOCUS TECHNIQUES



SHIATSU KNEADING

## Chinese



This massage will focus on your entire back while also massaging your legs and feet.

### FOCUS AREAS

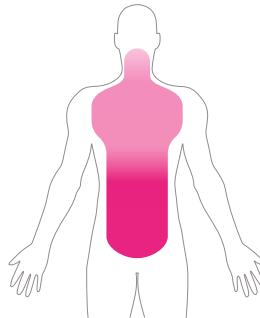

### INTENSITY



### FOCUS TECHNIQUES



KNEADING TAPPING

## Balinese



This massage will focus on your back and spine using fast, ultra kneading and tapping techniques.

### FOCUS AREAS

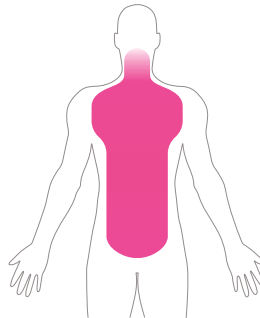

### INTENSITY



### FOCUS TECHNIQUES



KNEADING TAPPING

## Morning



This program is a relaxing massage that will help ease you into your day.

### FOCUS AREAS

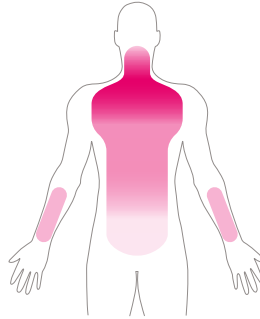

### INTENSITY



### FOCUS TECHNIQUES



KNEADING SWEDISH

## Night



The program is a calming massage that will get your mind and body ready for bed.

### FOCUS AREAS

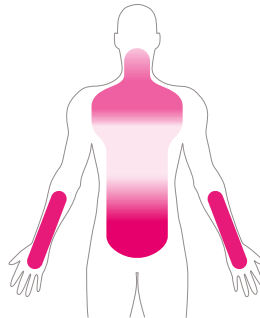

### INTENSITY



### FOCUS TECHNIQUES



KNEADING TAPPING

## AI Design



This is a full body program that creates the most accurate and suitable massage for the human body

### FOCUS AREAS

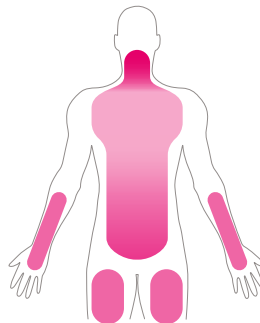

### INTENSITY



### FOCUS TECHNIQUES



SWEDISH KNEADING

## Post Workout



A program that is designed to help your muscles recover and to relieve body tension after you exercise.

### FOCUS AREAS

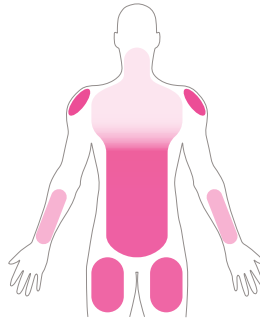

### INTENSITY



### FOCUS TECHNIQUES



KNEADING SWEDISH TAPPING

## Recharge

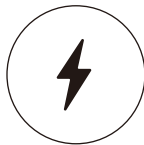

Use this program when you are tired to reenergize your body.

### FOCUS AREAS

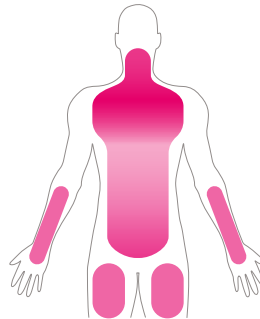

### INTENSITY



### FOCUS TECHNIQUES



KNEADING ROLLING

## Yoga Stretch



This program uses yoga exercises (asana) for warm up and stretching - this helps you wake up quickly and provides a gentle stretch for the muscles.

### FOCUS AREAS

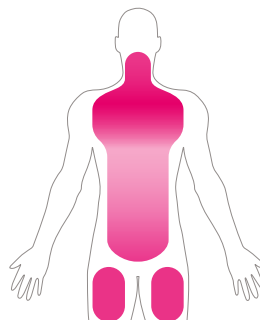

### INTENSITY



### FOCUS TECHNIQUES



KNEADING TAPPING CLAPPING

## Deep Tissue



A deep tissue massage to relieve your muscle tension.

## FOCUS AREAS

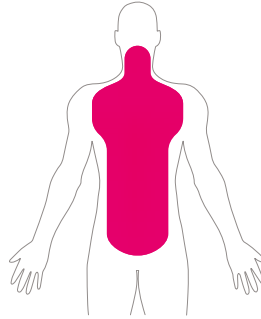

## INTENSITY



## FOCUS TECHNIQUES





# SAFETY PRECAUTIONS

We're looking out for you.

## IMPORTANT SAFETY INSTRUCTIONS

When using this massage chair, basic precautions should always be followed, including the following:  
Read all instructions before using this massage chair.

**DANGER** - To reduce the risk of electric shock:

- Always unplug this massage chair from the electrical outlet immediately after using and before cleaning.
- Never use pins or other metallic fasteners with this appliance.
- Carefully examine the covering before each use. Call for service if the covering shows any sign of deterioration, such as blistering, peeling or cracking.
- Keep dry - do not operate in a wet or moist condition.

**WARNING** - To reduce the risks of burns, fire, electric shock or injury to persons:

- Read all instructions before using.
- A massage chair should never be left unattended when plugged in. Unplug from the outlet when it is not in use and before putting on or taking off parts.
- Close supervision is necessary when this massage chair is used by or near children or disabled persons. Keep children away from reclining backrest and extended leg rest.
- Use this massage chair only for its intended use as described in this manual.
- Never operate this massage chair if it has a damaged cord or plug, if is not working properly, if it has been dropped or damaged, or dropped into water. Contact customer service department.
- Keep the cord away from heated surfaces.
- Never operate the massage chair with the air openings blocked. Keep the air openings free of lint, hair and the like.
- Never drop or insert any object into any opening.
- Do not use outdoors.
- Do not operate where aerosol (spray) products are being used or where oxygen is being administered.
- To disconnect, turn all controls to the off position, then remove the plug from the outlet.
- Do not stand on or in the massage chair. Use only while seated.
- The product is not intended for use by children or persons with reduced physical, sensory or mental capabilities, or lack of experience and knowledge, unless they have been given supervision or instruction concerning use of the product by a person responsible for their safety.
- Children should be supervised to ensure that they do not play with the product.
- Temperatures sufficiently high to cause burns may occur regardless of the control setting. Do not use on an infant or invalid or on a sleeping or unconscious person. Check the skin in contact with the heated area of the appliance frequently to reduce the risk of blistering.
- Burns may result from improper use.
- Do not crush in order to avoid sharp folds.
- Keep children away from extended foot support (or other similar parts).
- DO NOT WET.
- DO NOT USE PINS.
- NEVER REMOVE COVER.
- Connect this appliance to a properly grounded outlet only. See Grounding Instructions.

## SAVE THESE INSTRUCTIONS

This massage chair is intended for household use only.

### 1. Usage Environment

- Do not use the massage chair in an excessively humid or dusty environment as this may result in malfunction or electric shock.
- Do not use the massage chair in a room with a temperature of 104°F or higher.
- Do not expose the massage chair to heaters, stoves or direct sunlight.
- Place and use the massage chair on an even, non-slip floor.
- The massage chair is designed for home use and not for commercial purposes.



#### Caution

- This massage chair is to be used indoors only.
- If you use the massage chair in a cold room, do not increase the room temperature abruptly. It is recommended that you increase the temperature gradually to a normal level.
- If the massage chair is stored in a cold place and is being brought into a warm environment, it is advisable to wait for one hour before use. This is because its performance may not be at an optimal level, as there may be water droplets on the mechanical parts due to condensation. Using the massage chair under such conditions may result in malfunction.

### 2. Safety Precautions

- To ensure safe and correct use of the massage chair, do not operate it without reading this operation manual carefully.
- Do not use the massage chair when the upholstery or seat is removed. This may cause injury or malfunction.
- Do not use the massage chair in combination with other therapeutic equipment or electric blanket etc., as this may result in ineffectiveness or injury.
- Do not use the massage chair an hour before or after eating as this may have adverse effects on the user.
- Do not allow children or pets to play around the massage chair, e.g. behind the backrest, under the seat base or legrest of the massage chair. This may result in injury.
- Do not use the massage chair when your body is wet.
- Do not operate the massage chair with wet hands.
- It is not recommended to use the massage chair for more than 30 minutes.
- Do not perform continuous massage on the same spot of your body for more than 5 minutes at a time as this may result in excessive stimulation and may have adverse effects.
- Do not insert your hand or foot along the paths of the massage rollers during use as this may cause injury.
- Stop operation immediately if you feel any discomfort.
- This product is not intended for self-treatment of conditions that should be managed by a qualified health care provider.
- People on medication or with medical conditions, please consult your doctor before use.
- Please do not use the product if you are not feeling well.

### 3. People with Medical Conditions

Consult your doctor before use if you:

- Are under medical rest as ordered by a doctor.
- Have spinal disorders, an abnormal spinal condition or have suffered a spinal injury.
- Have back problems.
- Have diabetes, osteoporosis or sensory impairment.
- Have joint dysfunction such as rheumatism, hammertoe or gout.
- Have a pacemaker or other electronic medical devices.
- May be pregnant.
- Have phlebitis or thrombosis.
- Have an increased risk for blood clots.
- Had recent surgery.
- Have surgical pins, screws, or anything mechanical in the legs, ankles or feet.



## Caution

- Avoid using the massage chair under the influence of alcohol.
- Do not apply massage rollers directly on the head, elbow or knee joints, torso or abdomen.
- If your legs or feet slip off the leg rest during massage, do not force them back in as this may result in injury.
- Remove the power plug from the electrical outlet immediately should liquid be accidentally spilled onto the massage chair. Do not use wet hands to connect or disconnect the power plug from the electrical outlet.
- Do not tamper with the power cord or use the massage chair with a damaged cord as this may result in malfunction and electric shock.

## 4. Instances When the Massage Chair Should Not Be Used

In the following events, please switch off the main power switch immediately and disconnect the power cord from the electrical outlet:

- If liquid is accidentally spilled onto the massage chair. This may result in electric shock or malfunction.
- If the fabric of the backrest is torn and the internal components are exposed.
- If pain or discomfort is felt during massage, stop operation immediately and consult your doctor.
- If you detect any malfunction or any other abnormal condition during operation.
- If there is power failure. Injury may occur when power is restored unexpectedly.
- If there is lightning.

## 5. Assembly and Repair of the Massage Chair

- Do not disassemble the backrest cover of the massage chair. Touching the internal components may result in malfunction or electrical shock.
- This massage chair must only be professionally serviced or repaired. Only disassemble or repair the massage chair if directed by a Ogawa service rep.

## 6. Things to Be Noted About the Power Plug and Cord

- Check that the Alternating Current (AC) voltage corresponds with the specifications indicated for the massage chair.
- Do not connect or disconnect the power plug from the electrical outlet with wet hands. This may result in malfunction or electric shock.
- When disconnecting the power plug, pull it by holding the plug, not the cord.
- Although operation will be stopped automatically by the Auto-Timer function, always remember to switch off the main power after use.
- Do not place the power cord under the massage chair or under any other heavy objects.
- Do not wind the power cord around the massage chair as this may damage the cord and result in a fire or electric shock.
- Do not operate the massage chair with a damaged cord or extension cord.
- Do not use the massage chair if the electrical outlet is loose.
- If the power cord is damaged, it should be replaced by a qualified technician.

# GROUNDING INSTRUCTIONS

This product must be grounded. If it should malfunction or break down, grounding provides a path of least resistance for the electric current to reduce the risk of electric shock. This product is equipped with a cord that has an equipment-grounding conductor and a grounding plug. The plug must be plugged into an appropriate outlet that is properly installed and grounded in accordance with all local codes and ordinances.

**Danger** - Improper connection of the equipment-grounding conductor can result in a risk of electric shock. Check with a qualified electrician or service technician if it will not fit the outlet. Have a proper outlet installed by a qualified electrician.

This product is for use on a nominal 120V circuit and has a grounding plug that looks like that plug illustrated below. Make sure that the product is connected to an outlet having the same configuration as the plug. No adapter should be used with this product.

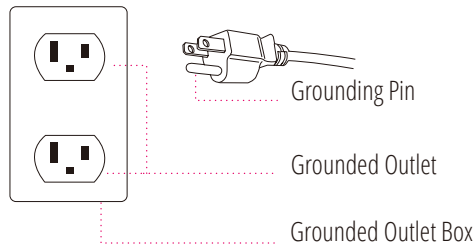

# TROUBLESHOOTING

This massage chair is controlled by a microcomputer and is thus susceptible to power surges of +10 to -15%. The following situations may arise in the event of a power surge:

Situation	Solution
The massage chair is connected to the power supply but is not functioning	<ol style="list-style-type: none"><li>1. Check to see that the plug is properly connected and working</li><li>2. Ensure the massage chair switch is in the 'I' position</li></ol>
The remote control works but the massage chair is not functioning	Possible overheating due to prolonged use. Turn off the power for at least 30 to 50 minutes
Both the remote control and the massage chair are not functioning	<ol style="list-style-type: none"><li>1. Ensure the chair is plugged into a working outlet</li><li>2. Turn the power OFF and ON again</li></ol>

If you continue to have problems, please read the warranty card and contact the Ogawa service department.

# PRODUCT CARE AND STORAGE

## 1. Storing the Massage Chair

- Wipe off dust and dirt from the massage chair with a dry, soft, clean cloth after use.
- Keep the massage chair clean and away from places of high humidity.
- If the massage chair is not to be used for a long period of time, cover the massage chair with a dust cover and unplug its power plug from the electrical outlet.

### Caution

- Do not store the massage chair in direct sunlight or in places of high temperature. This may cause the color of the upholstery to fade.
- Do not allow the massage chair to remain in contact with vinyl or wallpaper for extended periods of time as this could lead to discoloration.

## 2. Cleaning the Massage Chair

- Before cleaning, ensure that the main power switch is off and the power plug is disconnected from the electrical outlet.
- Wipe off dust and dirt from the massage chair with a dry, soft, clean cloth after each use.
- This product can be cleaned thoroughly with a slightly damp cloth.
- Do not iron the upholstery.
- Do not wash the upholstery using a home washing machine as this may result in deterioration of the upholstery's quality.

### Caution

- Do not use abrasive cleaning agents like benzene or thinner to clean the massage chair. This may cause the upholstery to fade.

## 3. Cleaning the Controller

- Use only a clean, dry cloth to clean the controller.

### Caution

- Do not use a wet cloth to clean the controller. This may result in malfunction.

# OGAWA CONSUMER WARRANTY

The Ogawa Master Drive Duo has the following warranty:

The Ogawa Master Drive Duo massage chair has a three-year in-home service and parts warranty.

Ogawa customer service will not issue Return Material Authorizations (RMAs) for products. Ogawa products will be either repaired by the consumer or by an in-home technician. Ogawa will not issue Return Material Authorizations (RMAs) for buyer's remorse.

## Service And Technical Support

Consumers may contact Ogawa's customer service department at 844-438-6429 between 9:00 am and 5:00 pm PST, Monday through Friday, or email us at [support@ogawaworldusa.com](mailto:support@ogawaworldusa.com), or visit our web at [www.ogawaworldusa.com](http://www.ogawaworldusa.com) for warranty or service issues.

Consumers are required to provide the unit serial number and dated proof of purchase (sales receipt) when they contact the Ogawa service department regarding a repair.

An Ogawa customer service representative will attend to most consumer inquiries, but in some cases a technical service specialist will provide advanced support.

Non-warranty repair is provided on a "per incident" basis. Ogawa customer service will verify that the unit has failed and provide instructions for repairing a unit. All applicable repairs, parts, shipping, handling, local tax and a "per incident" fee will be charged for non-warranty repairs and support calls.

Proof of purchase (original receipt) is required for all warranty repairs or service.

## Extended Warranties:

Ogawa offers extended warranty programs to enhance the ownership of your massage chair. Please call customer service at 844-438-6429 for details and pricing.

## Product Repairs

- Floor Models and Demonstration Units have a prorated warranty period that begins the day the model is placed on the floor and connected to an electrical outlet by the retail partner. Proof of purchase is required in order to obtain warranty service and parts. Non-warranty parts and service are available at a "per incident" charge.
- Warranty Coverage Period - Warranty coverage starts at the time that the consumer PURCHASES their chair. Proof of purchase is required for all warranty repairs. The warranty time period is measured by continuous calendar days based on a seven-day week.
- Field Service - The Ogawa customer service department will diagnose and schedule an authorized service provider to repair the chair in the consumer's residence.
- Parts - All parts deemed necessary for repairs will be shipped to the consumer at no charge by the Ogawa service department. Some Ogawa product repairs may be performed by the consumer in their own home with parts and instructions supplied by Ogawa, such as remote controller replacements that don't require a technician.

## CONSUMER WARRANTY LIMITATIONS AND EXCLUSIONS

- Warranties are only valid in the 48 contiguous United States and Canada and are contingent upon the consumer operating the chair according to the corresponding instruction manual.
- The warranty only applies to Ogawa products and does not include any accessories or enhancements.
- Field service requires pre-approval and must be performed by Ogawa's authorized field service personnel.
- Field service is only available in the United States and in major metropolitan areas in Canada.
- Softening of foams and filling composites in pillows, pads, and memory foam occurs naturally and does not constitute a defect under this warranty.
- Fading, wear and piling of fabrics occurs naturally and does not constitute a defect under this warranty.
- Warranties do not cover any loss or damage resulting from improper installation, unauthorized repairs or modifications, improper use of electrical/power supply, loss of power, dropped product, a malfunction or damage of an operating part from failure to provide manufacturer's recommended maintenance, transportation damage, theft, abuse, misuse, neglect, vandalism or environmental conditions (fire, floods, rust, corrosion, sand, dirt, windstorm, hail, earthquake or exposure to weather conditions).
- Warranties do not cover any loss during the time spent waiting for parts or repairs.
- Under no circumstance shall Ogawa or its representatives be liable for indirect, consequential, or incidental damages (including damages for lost profits, business interruption, bodily injury, medical and the like).
- Warranties are non-transferable.
- Ogawa's sole liability and the purchaser's exclusive remedy shall be for the repair, or at Ogawa's option, for the replacement of the defective part.
- Notwithstanding the above, if replacement parts for defective materials are not available, Ogawa reserves the right to make substitutions in lieu of repair or replacement.
- All warranties begin on the DATE OF PURCHASE; no allowance or extension is offered for delivery and/or installation.
- Warranties do not apply to rental, business, commercial, institutional or other non-residential users.





**OGAWA**

861 S. Oak Park Road,  
Covina, CA 91724

TEL: 844-438-6429  
support@ogawaworldusa.com

[www.ogawaworldusa.com](http://www.ogawaworldusa.com)