

MEASURE NECKLACE LENGTH



Take thread or chain and place it around your neck hanging it till the point you want your pendant or chain to appear.

Check the length of the thread or chain on a ruler and check in this picture for your necklace level at different sizes.

Chain Reference Guide



MEASURE KID'S BRACELET LENGTH

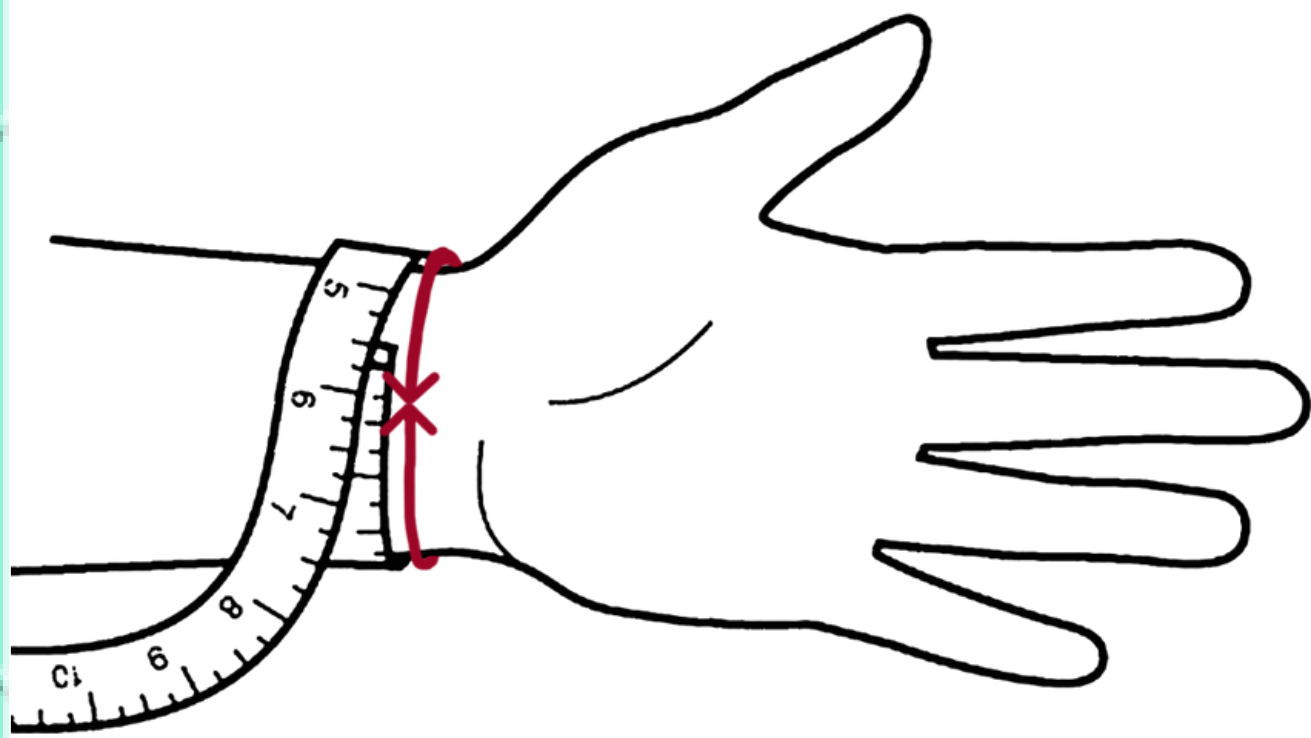

Measure the length of your child's wrist with thread or any flexible strip.

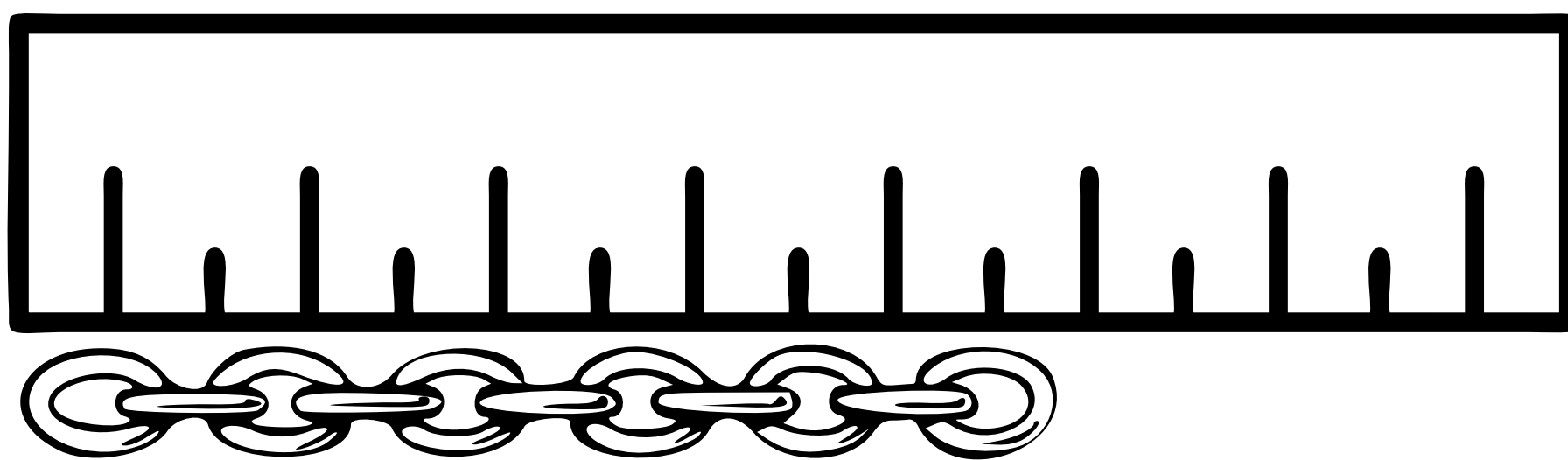

Check the length of the thread or string on a ruler and you will get the wrist size of your child for the bracelet

<i>size</i>	<i>measurement</i>
2 years	5 1/4 inches
3 years	5 1/2 inches
4-5 years	5 3/4 inches
6-7 years	6 inches
8-9 years	6 1/4 inches
10-11 years	6 1/2 inches
12-13 years	6 3/4 inches
14-over	7 inches

*Measure the wrist length for accurate size

MEASURE BRACELET LENGTH

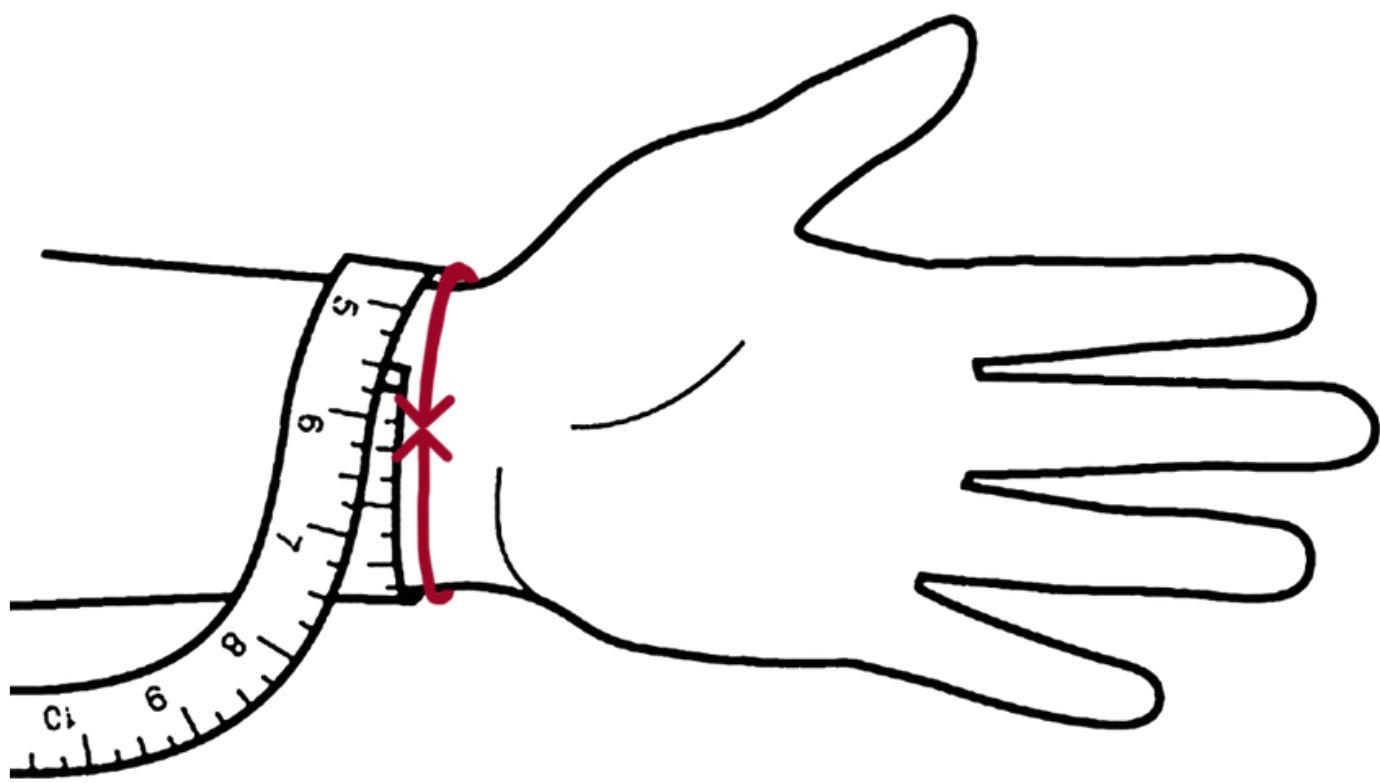

Measure the length of your wrist with thread or any flexible strip.

Check the length of the thread or string on a scale and you will get your wrist size for the bracelet

Bracelet Sizing Chart

Wrist Size (Inches)	Wrist Size (CM)	Women's Bracelet Size	Men's Bracelet Size
5-5.5"	12.7-14.0	X-Small	
5.5-6"	14.0-15.2	Small	
6-6.5"	15.2-16.5	Medium	
6.5-7"	16.5-17.8	Large	Small
7-7.5"	17.8-19.0	X-Large	Medium
7.5-8"	19.0-20.3	2X-Large	Large
8-8.5"	20.3-21.6	3X-Large	X-Large
8.5-9"	21.6-22.9		2X-Large
9-9.5"	22.9-24.1		3X-Large

RING SIZE GUIDE

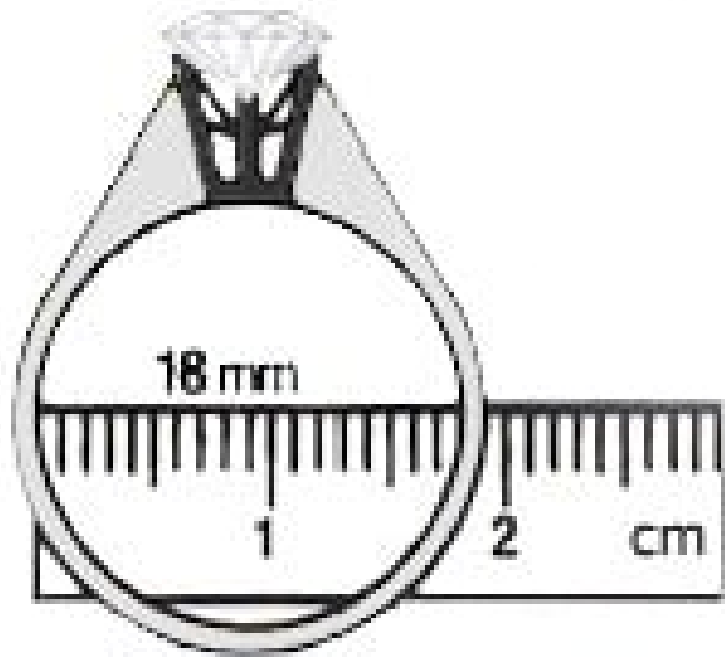

Measure the inner diameter of a ring you are already wearing with a ruler.

Check the diameter length of your ring on this chart and you will get US size of your ring.

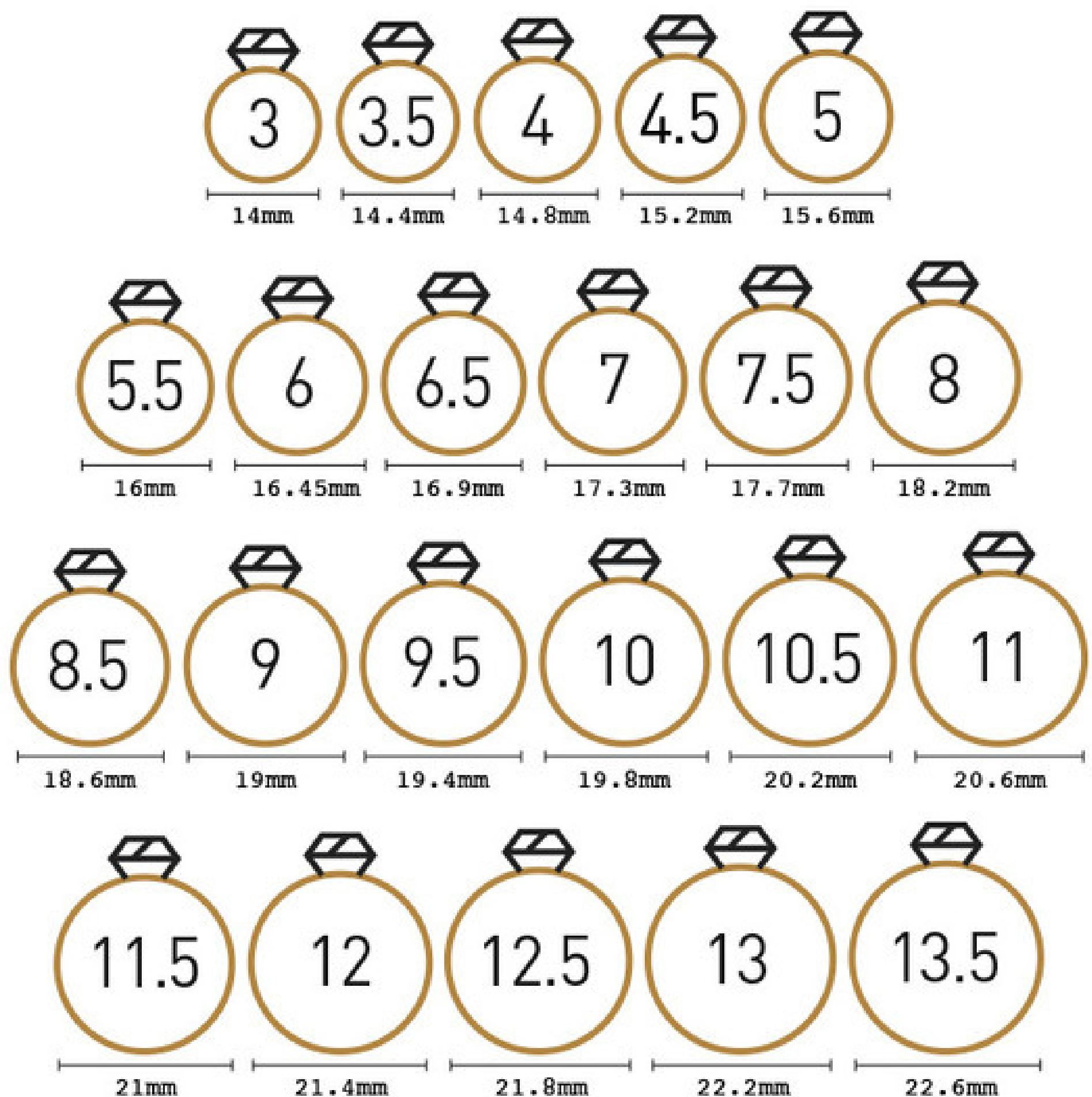

BANGLE SIZE GUIDE

Method 1

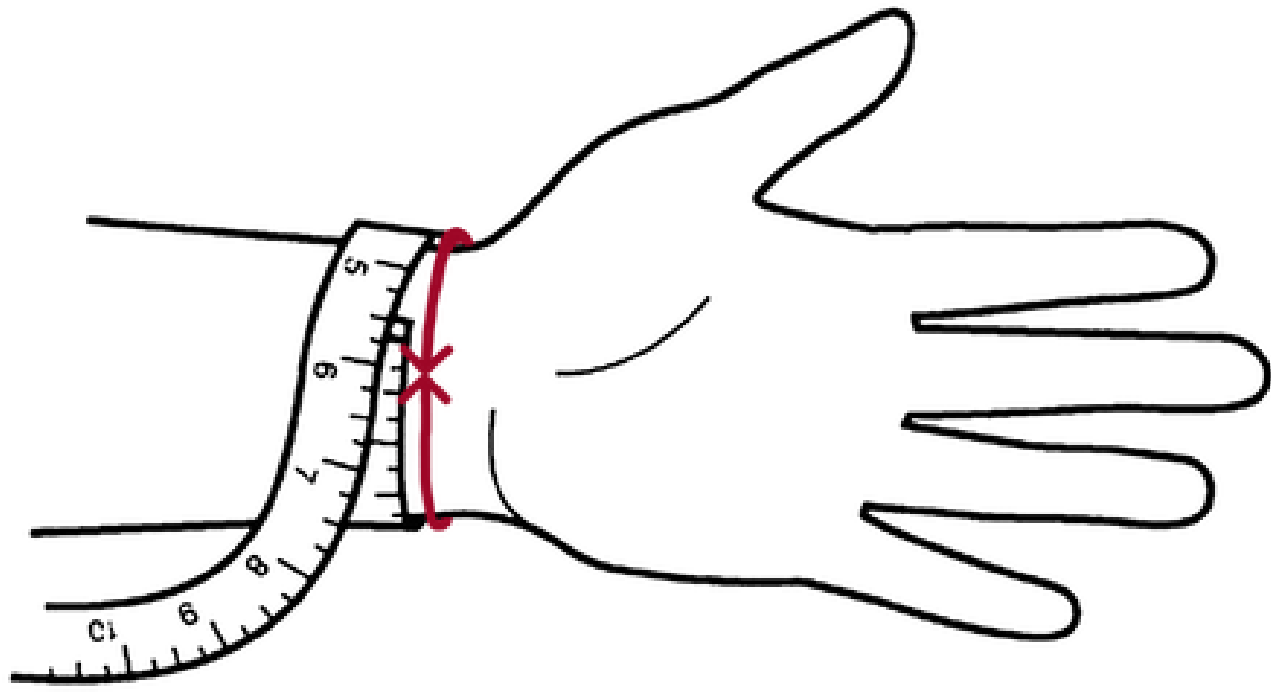

Measure the length of your wrist with thread or any flexible strip.

BANGLE SIZE GUIDE

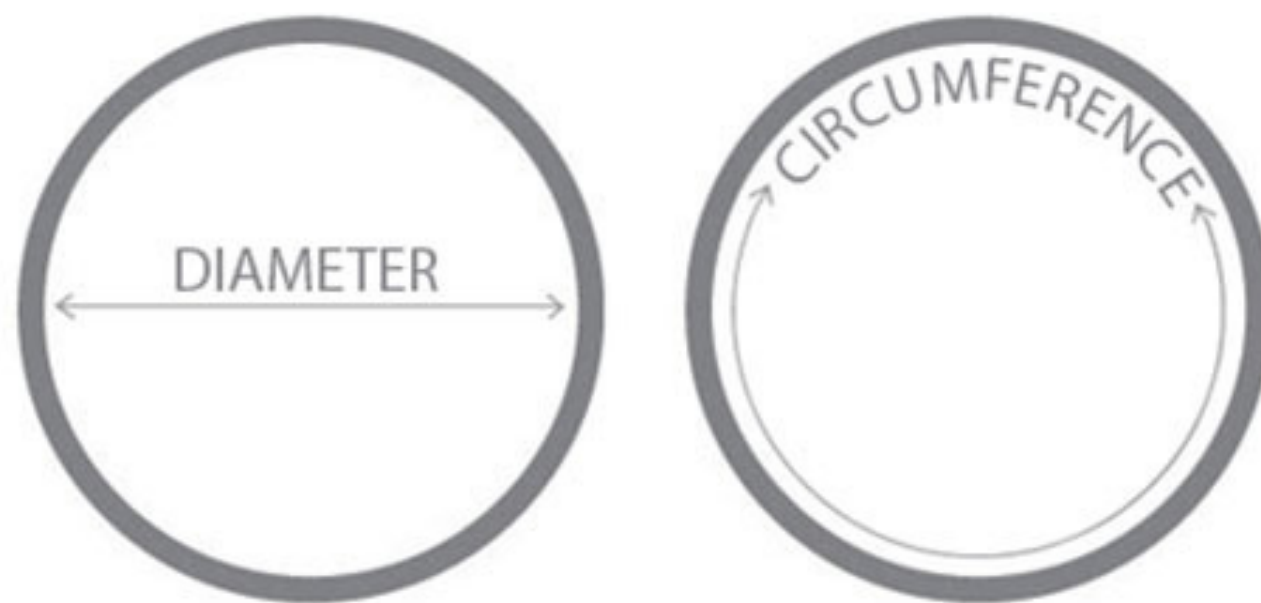

Check the length of the thread or string for inner circumference of your bangle

SIZE	DIAMETER		CIRCUMFERENCE	
	In Inch	In mm	In Inch	In mm
XS	2.25 in	57 mm	7 in	178 mm
S	2.37 in	60 mm	7.5 in	190 mm
M	2.5 in	63 mm	7.85 in	200 mm
L	2.62 in	66 mm	8.25 in	210 mm
XL	2.75 in	70 mm	8.65 in	220 mm

BANGLE SIZE GUIDE

Method 2

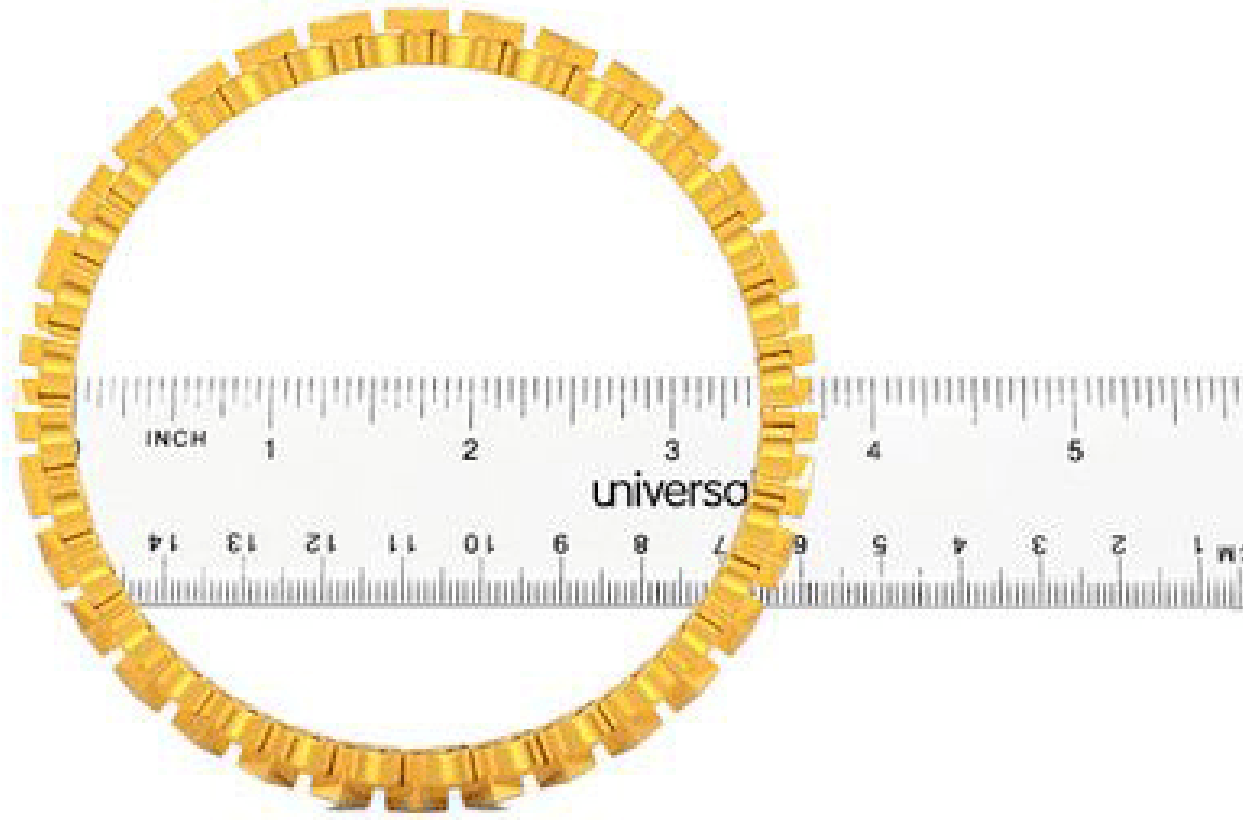

Measure the diameter of a bangle you are already wearing on a ruler

BANGLE SIZE GUIDE

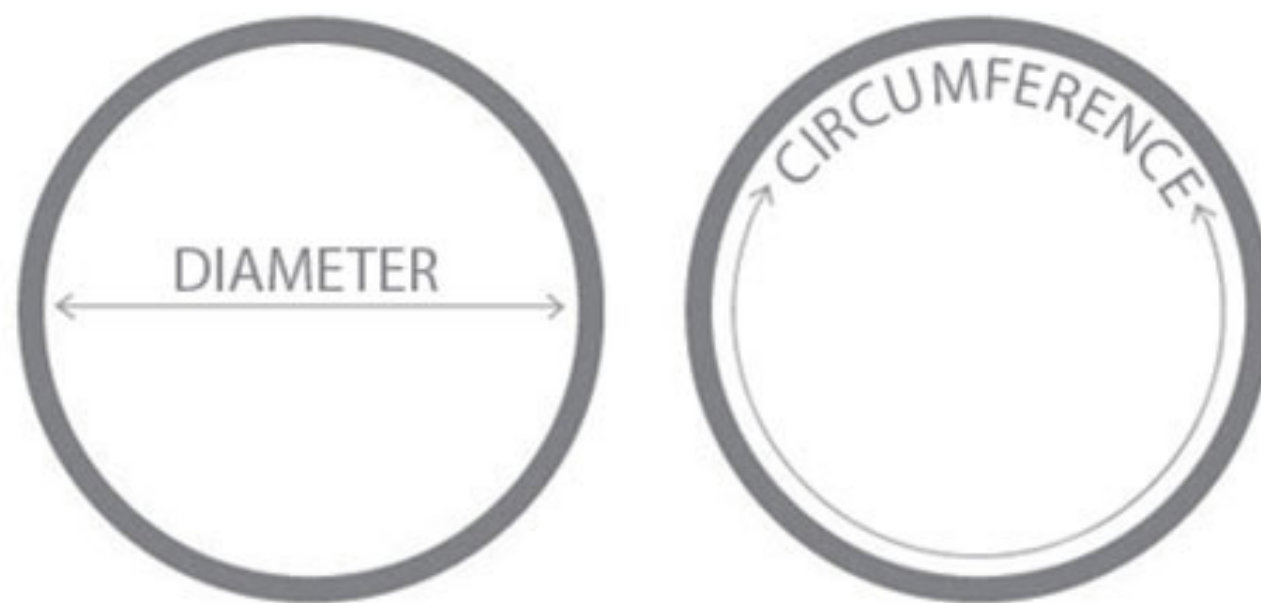

Check the diameter length and compare it from the chart for your bangle size

SIZE	DIAMETER		CIRCUMFERENCE	
	In Inch	In mm	In Inch	In mm
XS	2.25 in	57 mm	7 in	178 mm
S	2.37 in	60 mm	7.5 in	190 mm
M	2.5 in	63 mm	7.85 in	200 mm
L	2.62 in	66 mm	8.25 in	210 mm
XL	2.75 in	70 mm	8.65 in	220 mm