

# Installation Guide

Hardie™ Oblique™ & Stria™ Cladding  
Horizontal and Vertical

## EXTERIORS

**Australia** March 2023

**Make sure your information is up to date.**

When specifying or installing Hardie™ products, ensure that you have the current technical information and guides. If in doubt, or you need more information, visit [jameshardie.com.au](http://jameshardie.com.au) or contact James Hardie on 13 11 03.



## CONTENTS

1	INTRODUCTION	2
2	SAFE WORKING PRACTICES	3
	Warning	3
	Recommended safe working practices	3
	Storage and handling	3
3	DESIGN CONSIDERATIONS	3
	Framing	4
	Fasteners	4
4	PRODUCTS AND ACCESSORY DETAILS	5
	Components	5
	Fasteners, Battens and Tapes	6
5	PANEL INSTALLATION - HORIZONTAL DIRECT FIX	7
6	PANEL INSTALLATION - HORIZONTAL CAVITY FIX	8
7	CONSTRUCTION DETAILS - DIRECT FIX	9
	Junction Details	9
	External Corner Details	10
	Internal Corner Details	10
	Window Details	11
8	CONSTRUCTION DETAILS - CAVITY FIX	12
	Junction Details	12
	External Corner Details	13
	Internal Corner Details	13
	Window Details	14
9	FINISHES AND MAINTENANCE	15
	Surface Preparation	15
	Painting	15
	Maintenance	15
10	PRODUCT INFORMATION	15

## SCOPE

This guide covers the use of Hardie™ Oblique™ and Stria™ Cladding (Horizontal and Vertical) in a residential wall application over a seasoned timber wall frame or a light-gauge steel frame installed in a vertical upright application.

## CODEMARK CERTIFICATION

The CodeMark Certification Scheme is a voluntary third-party building product certification scheme that authorises the use of new and innovative products in specified circumstances in order to facilitate compliance with Volume 1 and 2 of the NCC.

Hardie™ Oblique™ and Stria™ Cladding has been certified under the CodeMark scheme (Certificate Number CM40223) and available at [www.jameshardie.com.au](http://www.jameshardie.com.au). This certificate can be provided to building certifiers and other regulatory authorities to facilitate the assessment of the product compliance or used to verify the suitability of the product for certain applications.

# 1 Introduction

## Hardie™ 14mm Shiplap Cladding

Create diverse modern designs with Hardie™ Oblique™ and Stria™ cladding boards.

Stria™ Cladding has a simple U-shaped groove spaced at 300mm or 380mm depending on the chosen size. Hardie™ Oblique™ Cladding has an asymmetrical groove with one square edge and a long oblique or slanting edge, the groove spacing is 175mm and 275mm depending on the profile. Both products can be installed in vertical or horizontal orientation for different looks.

**Vertical Orientation.** This is where the magic happens and Hardie™ Oblique™ Cladding looks modern reminiscent of standing seam metal cladding. Both Hardie™ Oblique™ and Stria™ Cladding can be oriented vertically for a modern on-trend look. When using the horizontal Hardie™ Castellated Batten installation method it's easy to mix and match the boards and create unique designs.

**Horizontal Orientation.** The cladding boards fixed direct to frame with the shiplap joints making installation simple and fast. Stria™ Cladding gives distinctive lines of large format shiplap boards. Hardie™ Oblique™ Cladding, on the other hand, with its slanted groove edge is reminiscent of a rusticated shiplap weatherboards.

## IMPORTANT NOTES

1. Failure to install, finish or maintain this product in accordance with applicable building codes, regulations, standards and James Hardie's written application instructions may lead to personal injury, affect system performance, violate local building codes, and void James Hardie's product warranty.
2. All warranties, conditions, liabilities (direct, indirect or consequential) and obligations whether arising in contract, tort or otherwise other than those specified in Hardie™ product warranty are excluded to the fullest extent allowed by law. For Hardie™ product warranty information and disclaimers about the information in this guide, visit [www.jameshardie.com.au](http://www.jameshardie.com.au).
3. The builder must ensure the product meets aesthetic requirements before installation. James Hardie will not be responsible for rectifying aesthetic surface variations following installation.

# 2 Safe Working Practices

## WARNING - DO NOT BREATHE DUST AND CUT ONLY IN WELL VENTILATED AREA

Fibre cement products manufactured by James Hardie contain sand, a source of respirable crystalline silica. **May cause cancer if dust from product is inhaled. Causes damage to lungs and respiratory system through prolonged or repeated inhalation of dust from product.** Intact fibre cement products are not expected to result in any adverse toxic effects. The hazard associated with fibre cement arises from the respirable crystalline silica present in dust generated by activities such as cutting, rebating, drilling, routing, sawing, crushing, or otherwise abrading fibre cement, and when cleaning up, disposing of or moving dust. When doing any of these activities in a manner that generates dust, follow Hardie™ instructions and best practices to reduce or limit the release of dust, warn others in the area and consider rotating personnel across the cutting task to further limit respirable silica exposure. If using a dust mask or respirator, use an AS/NZS1716 P1 filter and refer to Australian/New Zealand Standard 1715:2009 Selection, Use and Maintenance of Respiratory Protective Equipment for more extensive guidance and more options for selecting respirators for workplaces. For further information, refer to our installation instructions and Safety Data Sheets available at [www.jameshardie.com.au](http://www.jameshardie.com.au). FAILURE TO ADHERE TO OUR WARNINGS, SAFETY DATA SHEETS, AND INSTALLATION INSTRUCTIONS MAY LEAD TO SERIOUS PERSONAL INJURY OR DEATH.

### James Hardie Recommended Safe Working Practices

#### CUTTING OUTDOORS

1. Position cutting station so wind will blow dust away from the user or others in working area.
2. Warn others in the area to avoid dust.
3. Consider rotating personnel across cutting tasks to further limit respirable silica exposures.
4. Use one of the following methods based on the required cutting rate:
  - Best** ▪ Villaboard™ knife ▪ Hand guillotine ▪ Fibreshear
  - Better** ▪ Position the cutting station in a well-ventilated area. Use a dust reducing circular saw equipped with Hardie™ Blade Saw Blade or comparable fibre cement blade and well maintained M-class vacuum or higher with appropriate filter for capturing fine (respirable) dust. Wear a properly-fitted, approved dust mask or respirator (minimum P1).

#### CUTTING INDOORS

- Cut only using Villaboard™ knife, hand guillotine or fibreshears (manual, electric or pneumatic).
- Position cutting station in a well-ventilated area.

#### DRILLING/OTHER MACHINING

When drilling or machining you should always wear a P1 dust mask and warn others in the immediate area.

#### IMPORTANT NOTES

1. For maximum protection (lowest respirable dust production) James Hardie recommends always using best practice cutting methods where feasible.
2. NEVER use a power saw indoors or in a poorly ventilated area.
3. ALWAYS use a dust reducing circular saw equipped with a sawblade specifically designed to minimise dust creation when cutting fibrecement - preferably a sawblade that carries the Hardie™ Blade logo or one with at least equivalent performance - connected to a M class or higher vacuum.
4. NEVER dry sweep - Use wet suppression, or an M class vacuum or higher with appropriate filter.
5. NEVER use grinders.
6. ALWAYS follow tool manufacturers' safety recommendations.
7. ALWAYS wear a properly fitted, approved dusk mask, P1 or higher

#### DUST MASKS AND RESPIRATORS

As a minimum, an AS/NZS1716 P1 respirator must be used when doing any activity that may create dust. For more extensive guidance and options for selecting respirators for workplaces please refer to Australian/New Zealand Standard 1715:2009 "Selection, Use and Maintenance of Respiratory Protective Equipment". P1 respirators should be used in conjunction with the above cutting practices to minimise dust exposure. For further information, refer to Safety Data Sheet (SDS) available at [www.jameshardie.com.au](http://www.jameshardie.com.au). If concern still exists about exposure levels or you do not comply with the above practices, you should always consult a qualified industrial hygienist or contact James Hardie for further information.

## STORAGE AND HANDLING

To avoid damage, all Hardie™ building products should be stored with edges and corners of the product protected from chipping. Hardie™ building products must be installed in a dry state and protected from weather during transport and storage. The product must be laid flat under cover on a smooth level surface clear of the ground to avoid exposure to water, moisture, etc.

# 3 Design Considerations

All design and construction must comply with the appropriate requirements of the current National Construction Code (NCC) and other applicable regulations and standards.

## Slab and Footings

The slab and footings on which the building is situated must comply with AS 2870 'Residential slabs and footings – Construction' and the requirements of the NCC.

## Ground Clearances

Install Hardie™ external cladding with a minimum 150mm clearance to the earth on the exterior of the building or in accordance with local building codes if greater than 150mm is required. Maintain a minimum 50mm clearance between Hardie™ external cladding and roofs, decks, paths, steps and driveways.

Adjacent finished grade must slope away from the building in accordance with local building codes, typically a minimum slope of 50mm over the first metre.

Do not install external cladding such that it may remain in contact with standing water.

## NOTE

Greater clearance may be required in order to comply with termite protection provisions, see below for more information.

## Termite Protection

The NCC specifies the requirements for termite barriers. Where the exposed slab edge is used as part of the termite barrier system, a minimum of 75mm of the exposed slab edge must be visible to permit ready detection of termite entry.

## Fire Rated Walls

Hardie™ Oblique™ and Stria™ Cladding can achieve fire ratings of 60/60/60 and 90/90/90 when constructed with additional fire rated linings as specified in Hardie™ Fire and Acoustically Rated Design Manual and Construction of Fire and Acoustically Rated Walls Technical Specification. The length of fasteners must be increased for the additional linings.

## Moisture Management

It is the responsibility of designer or specifier to identify moisture related risks associated with any particular building design. Wall construction design must effectively manage moisture, accounting for both the interior and exterior environments of the building, particularly in buildings that have a higher risk of wind driven rain penetration or that are artificially heated or cooled.

In addition, all wall openings, penetrations, junctions, connections, window sills, heads and jambs must incorporate appropriate flashing and waterproofing. Materials, components and their installation that are used to manage moisture in framed wall construction must, at a minimum, comply with the requirements of relevant standards and the NCC.

## Weather Barrier

A suitable water control membrane must be installed under Hardie™ cladding in accordance with the AS/NZS 4200.2 'Pliable building membranes and underlays – Installation' and NCC requirements.

James Hardie has tested and certified the use of Hardie™ Weather Barrier for Climate Zones 2-8 within Australia. Hardie™ Weather Barrier is a Class 4 vapour permeable membrane that delivers a tripleshield of protection to help against external weather penetration, internal condensation management and external heat penetration through its safeglare reflective layer.

If using an alternate product in lieu of Hardie™ Weather Barrier or the project is located in a hot, humid area (Climate Zone 1), the designer must ensure that the product is fit for purpose and it has the following classification in accordance with AS/NZS 4200.1:2017 'Pliable building membranes':

TABLE 1

Weather Barrier Classification		
Climate Zone	Water Control Classification	Vapour Control Category
2-8	Water Barrier	Vapour Permeable (Class 3 or 4)
1		Vapour Barrier (Class 1 or 2)

Soft compressible insulation installed between the front of the wall studs and directly behind the external cladding can cause installation issues and is thus not recommended.

## Flashing

All wall openings, penetrations, intersections, connections, window sills, heads and jambs must be flashed prior to cladding installation.

## FRAMING

### General

Hardie™ Oblique™ and Stria™ Cladding are installed in a horizontal or vertical orientation. When installing horizontally, this can be done over a timber or steel frame and either direct fixed to frame or to Hardie™ Cavity Battens or timber battens. When installing in a vertical orientation, this must be only done over timber frames and using the Hardie™ Castellated Battens. The general framing requirements for installation are given in Table 2.

Maximum stud, Hardie™ Cavity Batten and fastener spacing for Hardie™ Oblique™ and Stria™ Cladding for wind load classifications of AS 4055 'Wind Loads for Housing' are given in Table 3, 4 and 6.

Ensure framing joints are tight and all framing is fully loaded before Hardie™ Oblique™ and Stria™ Cladding is installed.

TABLE 2

General Framing Requirements			
Type	Timber		Steel
Design	Use of timber framing must be in accordance with AS 1684 and the framing manufacturer's specifications		Use of steel framing must be in accordance with NASH standard for Residential and Low-Rise Steel Framing Part 1: Design Criteria and the framing manufacturer's specifications.
Durability	'Timber used for house construction must have the level of durability appropriate for the relevant climate and expected service life. Reference AS 1684.2 'Residential timber-framed construction'.		The steel framing must have the appropriate level of durability required to prevent corrosion, particularly in coastal areas.
Tolerances	Ensure frame is square and work from a central datum line. A suggested maximum tolerance of between 3mm and 4mm in any 3000mm length of frame will give best results.		
Thermal Break Requirement	Not required.		For steel frames, the NCC Sections J1.5 and 3.12.1 Volumes 1 and 2 respectively, state for both residential and commercial buildings a thermal break such as Hardie™ Break with an R 0.2m <sup>2</sup> K/W must be installed behind external cladding where the cladding and internal lining make direct contact with the same steel frame. Alternatively, off-stud vented cavity installation using Hardie™ Cavity Batten can be used in these applications.
BMT	N/A.		Framing members must have a base metal thickness (BMT) between 0.55 to 1.6mm.
Orientation	Horizontal		Vertical
Type	Direct Fix	Cavity Fix	Cavity Fix (Timber frame only)
Min. Stud Width	When using the Stria Vertical Stop: -Double 45mm stud, or -Triple 35mm studs 35mm studs elsewhere.	35mm	45mm
Min. Stud Depth	70mm	70mm	70mm
Min. Nogging Spacing	1350mm	Refer to table 5	900mm (all noggings must be aligned to provide support to the Hardie™ Castellated Batten)

## FASTENERS

### General

All nails must be driven flush. **Before fixing to steel frame, ensure the aesthetic finish of Hardie™ Oblique™ and Stria™ Cladding when using Hardie™ Drive screws is of acceptable quality prior to installation, see Important Note 3 on page 2 of this guide.** For more information and advice, Ask James Hardie™ on 13 11 03.

### Fastener Durability (Including Coastal Areas)

Fasteners must have the appropriate level of durability and be fully compatible with all other materials required for the intended project. In areas within 1km of a coastal area, areas subject to salt spray and other corrosive environments, class 4 fasteners must be used.

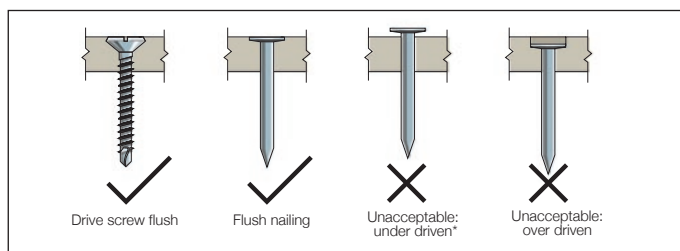

FIGURE 1 NAIL FASTENER DEPTH

\* Only when face fixing, fasteners can be under driven and tapped maximum 1mm below the surface of the board (Do not overdrive using gun nails). All fastener penetrations must be patched and sanded. Refer to the Finishing and Maintenance section on Page 15.

TABLE 3

Horizontal Stria™ Cladding Standard Profile and Hardie™ Oblique™ Cladding Fixing Options.							
Non-Cyclonic Wind	Cyclonic Wind	Fasteners Details			Fixing Figure	Max. Stud Spacing (mm)	
		Direct Fix	Cavity Fix	Configuration		General Areas of Walls	Within 1200mm of building edges
<b>Concealed Fixing Option</b>							
N1, N2	-	40 x 2.8mm Fibre Cement Nail	25 x 2.8mm Fibre Cement Nail	1 per board in underlap HAND NAILED	1	600	600 450 (For steel frame)
N3	C1	40 x 2.8mm Fibre Cement Nail	-	1 per board in underlap HAND NAILED	1	600	600 450 (For steel frame)
<b>Face Fixing Options</b>							
N1, N2, N3	C1	50mm ND or DA Brad Nail	32mm DA Brad Nail	2 per board-through face	2	600	600
N1, N2, N3	C1	50 x 2.8mm Fibre Cement Nail (Gun Nail)	-	1 per board-through face	2	600	600
N4	C2	50 x 2.8mm Fibre Cement Nail (Gun Nail)	-	1 per board-through face	2	600	450
N5, N6	C3, C4	50 x 2.8mm Fibre Cement Nail (Gun Nail)	-	2 per board-through face	2	450	300

TABLE 4

Horizontal Stria™ Cladding Wide Profile Fixing Options.							
Non-Cyclonic Wind	Cyclonic Wind	Fasteners Details			Fixing Figure	Max. Stud Spacing (mm)	
		Direct Fix	Cavity Fix	Configuration		General Areas of Walls	Within 1200mm of building edges
<b>Face Fixing Options</b>							
N1, N2, N3	C1	50mm ND or DA Brad Nail	32mm DA Brad Nail	2 per board-through face	2	600	600
N1, N2, N3	C1	40 x 2.8mm Fibre Cement Nail + (50mm ND or DA Brad Nail or 50 x 2.8mm Fibre Cement Nail (Gun Nail))	-	2 per board -1 in underlap, (Hand nailed) and 1 through face (Gun nail)	3	600	600
N4	C2	40 x 2.8mm Fibre Cement Nail + 50 x 2.8mm Fibre Cement Nail (Gun Nail)	-	2 per board -1 in underlap, (Hand nailed) and 1 through face (Gun nail)	3	600	450
N5, N6	C3, C4	50 x 2.8mm Fibre Cement Nail (Gun Nail)	-	3 per board-through face	2	450	300

## NOTES: FIXING TOP AND BOTTOM ROWS OF BOARDS

- For N1, N2, N3 & C1 Bottom and top boards must be fixed with brad nails at 150mm centres or 300mm centres for other fixings.
- For N4, N5, N6, C3 & C4 top and bottom board must be fixed at 150mm centres.
- Fixing at every stud. Unless otherwise stated all values are for timber & steel.
- For both concealed and face fixing, use minimum class 3 fasteners.

For steel framing thickness of 0.5mm – 1.6mm BMT use 41mm Hardie™ Drive screws. Hardie™ Break Thermal Strip must be installed behind the Hardie™ Oblique™ and Stria™ Cladding. Refer to the Hardie™ Break Thermal Strip Installation Guide for more information.

TABLE 5

Maximum span and fastener specifications for Hardie™ Cavity Trim or Timber Batten for horizontal cladding installation.					
Batten Type	Dimensions (mm)	Timber Frame		Steel Frame	
		Max. Span (mm)	Fasteners	Max. Span (mm)	Fasteners
Hardie™ Cavity Battens	70 x 19	800	2.8 x 65mm long ring shank nail or 75 x 2.8mm D or round head galvanised smooth shank nail.	800	Two Hardie™ Drive Screws - Class 3 self-tapping wing-tipped screw for fastening to 0.5mm to 1.6mm BMT light gauge steel frames. 1000 per box. Product Codes: 305984 (loose) 305982 (collated).
Timber Battens	70 x 35	1350	Two 75 x 3.06mm D Head Class 3 nails per fixing.	800	Two 10-24 x 65mm Class 3 selfdrilling CSK-Head screws per fixing.

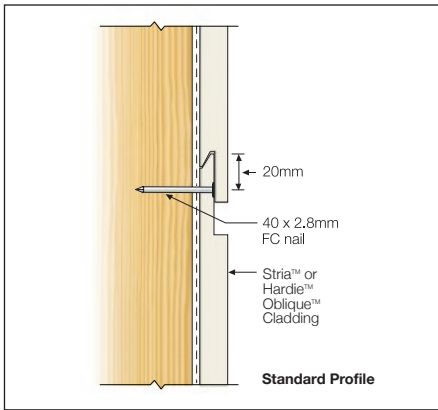

**FIGURE 1 CONCEALED FIXING FOR STANDARD PROFILE**

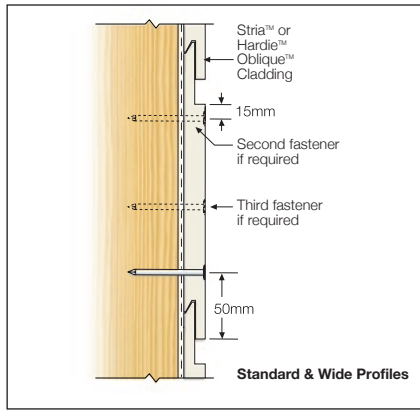

**FIGURE 2 FACE FIXING GUN & BRAD NAILS: FOR BOTH STRIA CLADDING PROFILES**

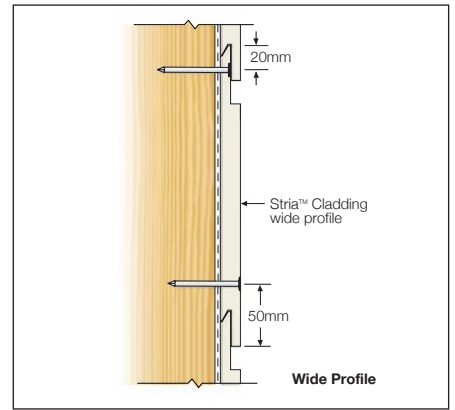

**FIGURE 3 FACE/CONCEALED FIXING FOR WIDE PROFILE**

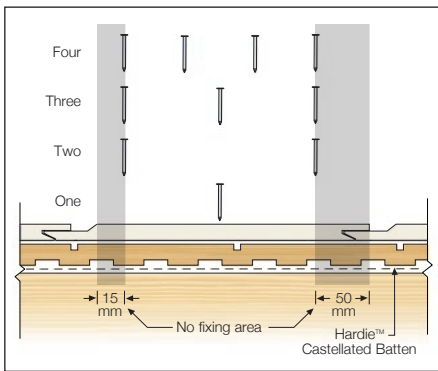

**FIGURE 4 POSITION OF MULTIPLES OF FASTENERS FOR FACE FIXING IN VERTICAL ORIENTATION**

**TABLE 6**

Vertical orientation fixing requirements							
Hardie™ Product	Width (mm)	Number of fasteners				Hardie™ Castellated Batten and nogging max. spacing (mm)	Maximum Stud spacing (mm)
		N1, N2, N3/C1		N4/C2			
		Within 1200mm of building edges	General Areas of Walls	Within 1200mm of building edges	General Areas of Walls		
Hardie™ Oblique™ Cladding	200	1	1	2	1	900*	600
	300	2	2	3	2		
Stria™ Cladding	325	2	2	3	2		
	405	3	2	4	2		

NOTES: Install using 65mmx2.87 ring-shank nails.

\* The Hardie™ Castellated Battens must be continuously supported by noggings.

# 5 Products and Accessory Details

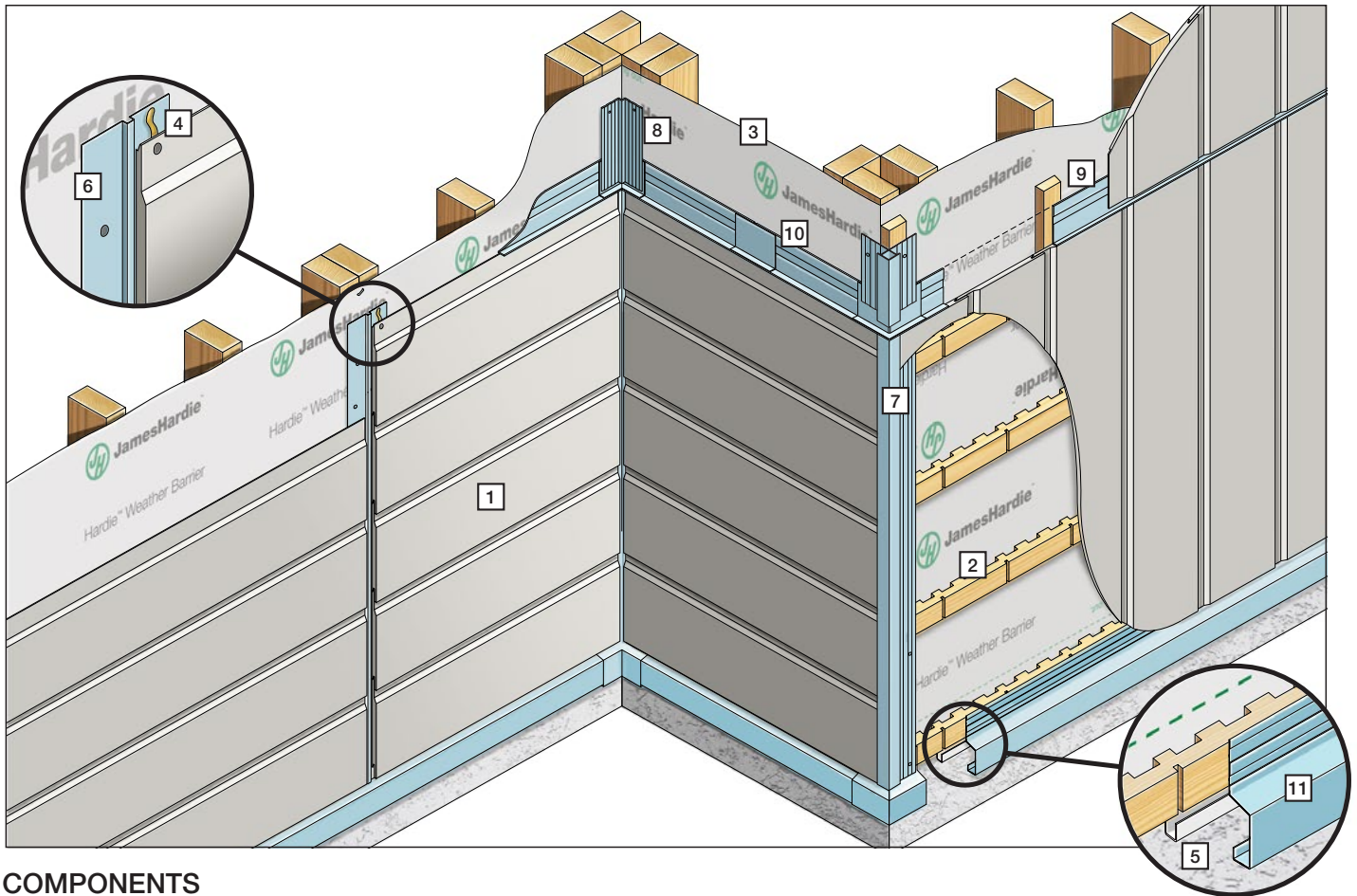

## COMPONENTS

1	Hardie™ Oblique™	Product Code	Length (mm)	Width (mm)	Mass (kg/unit)	Pack Size
 <p>Factory sealed 14mm profile featuring a unique bevel groove profile that creates a modern softer shadowline.</p>		405300	2750	200	9.5	75
		405302	2750	300	14.5	75
		405301	4200	200	14.6	45
		405303	4200	300	22.1	45
Stria™ Cladding		Product Code	Length (mm)	Width (mm)	Mass (kg/unit)	Pack Size
 <p>Pre-primed 14mm weatherboard that features a deep square groove, it's wide profile creates a sleek, robust look.</p>	Stria™ Standard	404063	4200	325	26	60
	Stria™ Wide	404413	4200	405	33	40

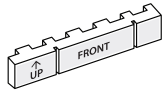
2	Hardie™ Castellated Batten
	<p>A non-structural, 45x20x2700mm castellated H3 treated timber batten used to allow ventilation in a wall cavity. Product code: 306181</p>

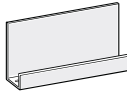

3	Hardie™ Weather Barrier
	<p>Water barrier and vapour permeable membrane. Unit size: 2.75 x 30m. Pack Size: 1 Each. Product Code: 305664 Coverage: 85.5m<sup>2</sup> per roll</p>

4	Hardie™ Joint Sealant
	<p>General purpose polyurethane exterior grade joint sealant. Pack Size: 20/Box. Product Code: 305534 300ml Cartridge Product Code: 305672 600ml Sausage Coverage: 2.67m/100ml (5mm dia bead)</p>

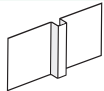
5	Hardie™ 18mm PVC Cavity Vent Strip
	<p>A perforated PVC extrusion used at the bottom of walls behind cladding. Pack Size: 25. Product Code: 305555</p>

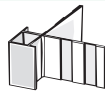
6	Stria™ Vertical Flashing
	<p>For use with Linea™ Cladding behind boards at vertical joints. Product Code: 306040 T flashing 3000mm (5/pack) Coverage: Length of horizontal joints / 3000mm</p>

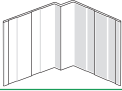
7	Hardie™ 14mm Aluminium External Box Corner
	<p>A ready to paint aluminium extrusion. 3000mm long. Pack Size: 5 Product Code: 305519 Coverage: Height of wall x no. of external corners / 3000mm</p>



Internal Corner Options	
8	Hardie™ 14mm Aluminium Internal Corner
	<p>A ready to paint aluminium extrusion. 3000mm long. Pack Size: 5. Product Code: 305518 Coverage: Height of wall x no. of external corners / 3000mm</p>
8	Hardie™ 75mm Corner Flashing
	<p>Manufactured using COLORBOND® steel, used behind cladding at internal and external corners. 75 x 75mm. Pack Size: 5. Product Code: 305564 Coverage: Height of clad walls x no. of corners / 3000mm</p>

9	Hardie™ Trimline Flashing
	<p>To be used at horizontal joints (vertical cladding) or vertical butt joints (Horizontal cladding). (5/pack) Product Code: 306128. 3000mm Coverage: Length of horizontal joints / 3000mm</p>

Horizontal Flashing	
10	Hardie™ TrimLine External & Internal Corner Jointers
	<p>For use with Hardie™ TrimLine Flashing at corner joints. External Corner Product Code: 306130 Internal Corner Product Code: 306131 (20/pack of each kind)</p>

10	Hardie™ TrimLine Horizontal Jointer
	<p>For use with Hardie™ TrimLine Flashing at horizontal joints. Product Code: 306132 (20/pack)</p>

<b>11 Hardie™ Edge Base Trim</b>	<b>11 Hardie™ Edge Base Trim Jointer</b>	<b>11 Hardie™ Edge Internal Corner</b>	<b>11 Hardie™ Edge External Corner</b>
			
<p>Powder coated aluminium extrusion used at slab edges. Pack Size: 25 units. Product Code: 305911</p>	<p>Powder coated aluminium extrusion used with Hardie™ Edge Base Trim. Pack Size: 12 units. Product Code: 305912</p>	<p>Powder coated aluminium extrusion used with Hardie™ Edge Base Trim at internal corner junctions. Pack Size: 4 units. Product Code: 305913</p>	<p>Powder coated aluminium extrusion used with Hardie™ Edge Base Trim at external corner junctions. Pack Size: 4 units. Product Code: 305914</p>

<b>Hardie™ Blade Saw Blade 185mm Diameter</b>	<b>Dust-Reducing Saw with M class or higher vacuum Extraction</b>	<b>Drop Saw*</b>
		
<p>Poly-diamond blade for Hardie™ fibre cement. Product Code: 300660 Pack Size: 1 each.</p>	<p>Dust reducing saw with a Hardie™ Blade saw blade. E.g. Makita 5057KB / Hitachi C7YA.</p>	<p>Drop saw with an aluminium blade. *Not to be used for cutting Hardie™ Oblique™ or Stria™ Cladding.</p>



# 6 Cladding Installation Steps\* - Horizontal

**STEP 1**

Ensure your frame is square, maximum tolerance of 4mm in 3000mm length.

Refer to Table 3 for maximum stud spacing

**STEP 2**

Fix at 300mm centres

Corrosion resistant flashing with min. 75mm upstand

Install the required corrosion resistant flashing over windows and other openings.

**STEP 3** ONLY REQUIRED FOR DIRECT FIX

Refer to Table 3

Install Hardie™ Edge Trim. Fix at max. 600mm centres (10mm min clearance from edge).

If you do not install Hardie™ Edge Trim, ensure to install a stringline for reference.

Damp proof course

min. 75 mm

**STEP 4**

Install Hardie™ Weather Barrier.

Overlap Hardie™ Weather Barrier 150mm at all horizontal joints and one stud bay at all vertical joints. Extend min. 150mm around corners

Refer to the Hardie™ Weather Barrier Technical Data Sheet for further information

Galvanised staple fastener every 450mm per stud

**STEP 5**

When using the Hardie™ Cavity Batten, install the Hardie™ PVC Cavity vent Strip.

Fix at 600mm centres maximum, with 10mm edge clearance.

Hardie™ PVC Cavity Vent mitred at corners and kept clear of debris. Do not insert Hardie™ Cavity Batten into the vent strip.

min. 150 mm

10 mm

**STEP 6**

Install the cavity trims (must be fixed off-stud on steel frames).

Timber frame option for on stud jointing.

50mm EPDM foam back sealing tape

Hardie™ Cavity Batten or timber batten. Refer to Table 3 for fastener spacing

Direct Fix steel frame option

Hardie™ Break Thermal Strip

20 mm min.

**STEP 7**

Installing vertical flashings. Internal and external corners and Stria™ Vertical Flashing if required.

Hardie™ 14mm Aluminium Internal Corner

Hardie™ 14mm Aluminium External Trim Corner

Stria™ Vertical Flashing†

Fix at max. 300mm centres (10mm min. clearance from the edge)

**STEP 8**

Apply sealant over Stria™ Vertical Flashing if using it.

Apply a continuous 6mm dia. bead of Hardie™ Joint Sealant to the Stria™ Vertical Flashing to the height of a few boards at a time.

Sealant to be 5mm away from vertical flashing stop and inside of fastener locations

Stria™ Vertical Flashing

**STEP 9**

Fix the first board maintaining a 20mm clearance from the edge.

Position first board with bottom on datum line. 20-50mm overhang from bottom plate and fix in place.

Hardie™ Cavity Vent Strip

† Needed where a vertical express joint is required.

**STEP 10**

Fit next board after fixing of top of board below. Ensure boards are locked firmly and are level.

Fix subsequent boards.

Min. 20mm

**STEP 11**

Apply sealant over vertical joints.

**STEP 12**

Paint the wall with an exterior acrylic paint within 3 months of being fixed or within 7 days if located within 1km of a coastal area or corrosive environment.

\*This is an overview of the installation process only. It is not a substitute for reviewing this document in its entirety prior to installation.

# 7 Cladding Installation Steps\* - Vertical

**STEP 1**

Ensure your frame is square, maximum tolerance of 4mm in 3000mm length.

All noggings must be aligned to provide support to the Hardie™ Castellated Batten.

Refer to Table 6 for maximum stud and nogging spacing.

**STEP 2**

Fix at 300mm centres

Corrosion resistant flashing with min. 75mm upstand

Install the required corrosion resistant flashing over windows and other openings.

**STEP 3**

Install Hardie™ Weather Barrier.

Overlap Hardie™ Weather Barrier 150mm at all horizontal joints and one stud bay at all vertical joints. Extend min. 150mm around corners.

Galvanised staple fastener every 450mm per stud

Refer to the Hardie™ Weather Barrier Technical Data Sheet for further information

**STEP 4**

Install vertical battens to each side of internal and external corners.

Hardie™ Castellated Batten

Fix at 600mm centres maximum, with 10mm edge clearance.

20mm min.

Hardie™ PVC Cavity Vent Strip mitred at corners.

min. 150mm

10mm

**STEP 5**

Install horizontal battens.

Top

Back

Front

Horizontal battens installed over noggings

**STEP 6**

Refer to Table 3

Hardie™ Castellated batten

Install Hardie™ Edge Trim. Fix at max. 600mm centres (10mm min clearance from edge).

If you do not install Hardie™ Edge Trim, ensure to install a stringline for reference.

Hardie™ PVC Cavity Vent Strip

min. 75mm

**STEP 7**

Install corner accessories as required. For alternative corners refer to Detailing section

Fix at max. 300mm centres (10mm min. clearance from the edge)

Max 300mm spacing between supports

**STEP 8**

Install Hardie™ Trimline flashing at horizontal joints.

**STEP 9**

Install Trimline joiners at butt joints and corners.

Apply two beads of Hardie™ Joint Sealant behind all Hardie™ Trimline Joiners

**STEP 10**

Install First Board.

Apply a continuous 4mm diameter bead of Hardie™ Joint Sealant to underside of the Hardie™ Trimline flange and along the corner accessories.

Push first board up against the flange. Refer to Table 6 for fastener spacing.

**STEP 11**

Fix Remaining Boards.

Ensure boards are locked firmly and are level.

**STEP 12**

Paint the wall with an exterior acrylic paint within 3 months of being fixed or within 7 days if located within 1km of a coastal area or corrosive environment.

# 8 Construction Details - Horizontal Board Orientation

## JUNCTION DETAILS

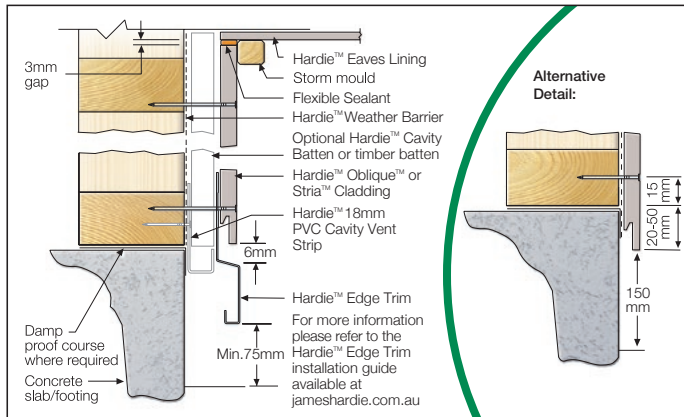

FIGURE 1 SLAB/EAVE JUNCTION DETAIL

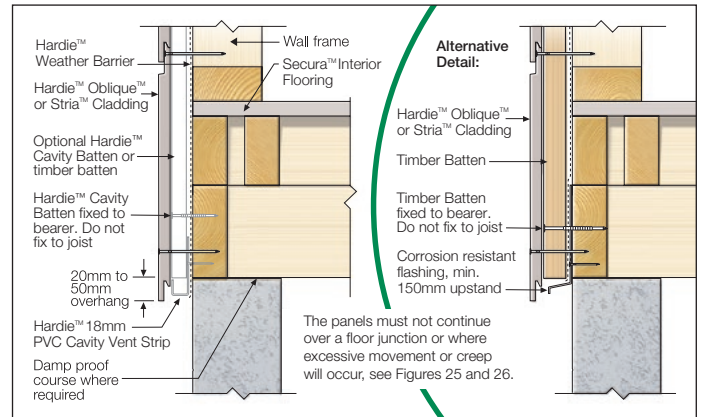

FIGURE 2 LOWER FLOOR JUNCTION

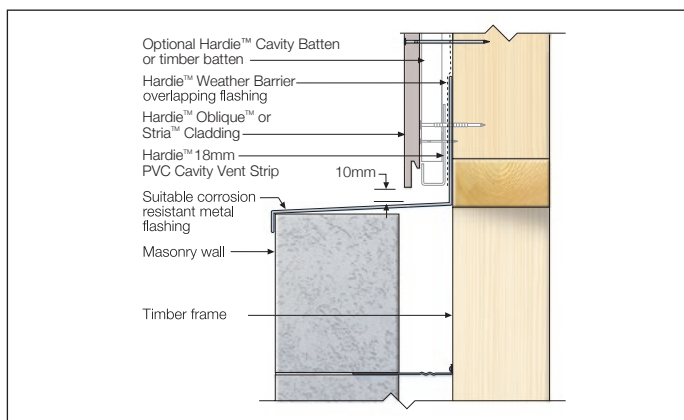

FIGURE 3 HORIZONTAL JUNCTION

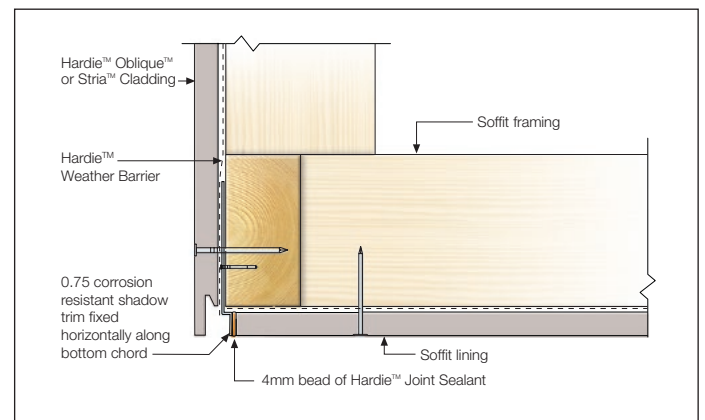

FIGURE 4 FACADE/SOFFT JUNCTION - DIRECT FIX

## INTERNAL CORNER DETAIL

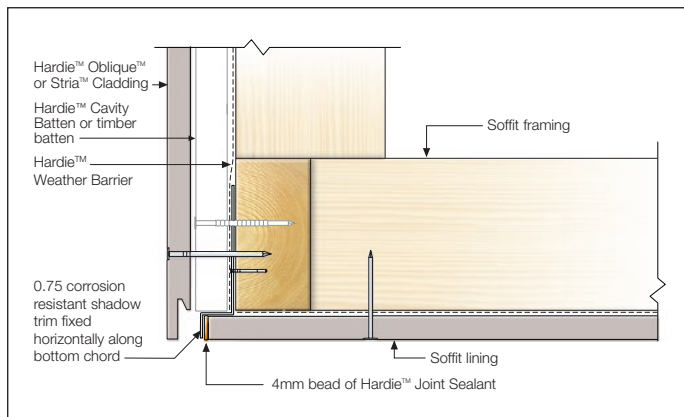

FIGURE 5 FACADE/SOFFT JUNCTION - CAVITY FIX

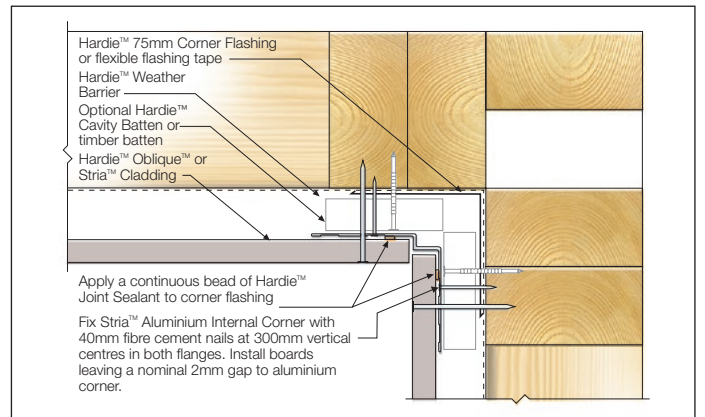

FIGURE 6 INTERNAL CORNER

## EXTERNAL CORNER DETAILS

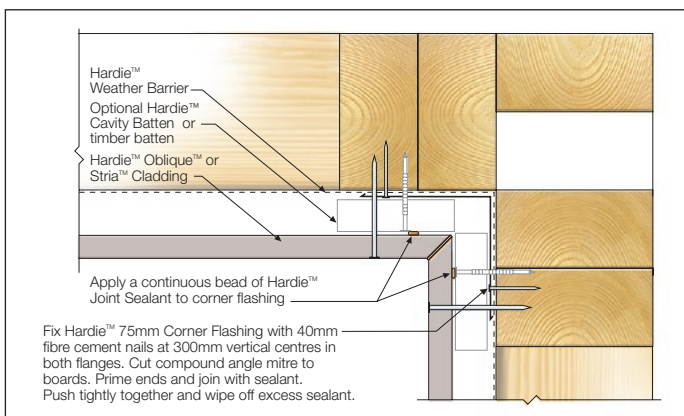

FIGURE 7 INTERNAL MITRE CORNER

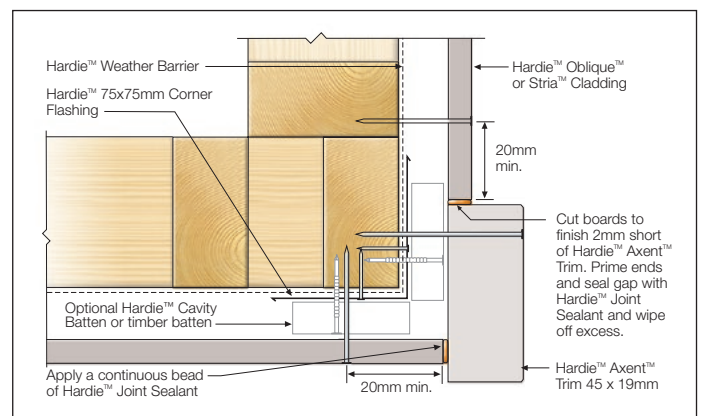

FIGURE 8 EXTERNAL TRIM CORNER

## JOINT DETAILS

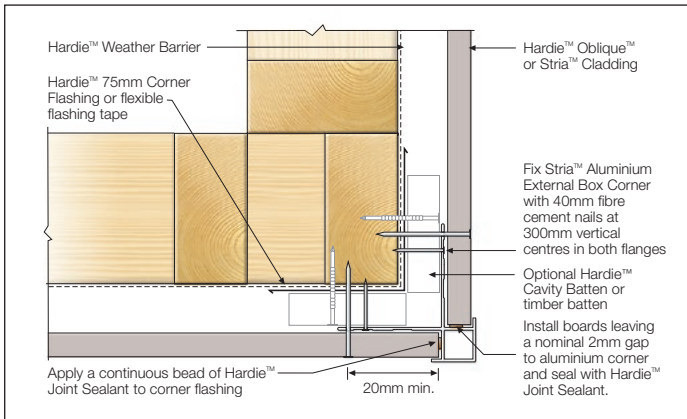

FIGURE 9 EXTERNAL BOX CORNER

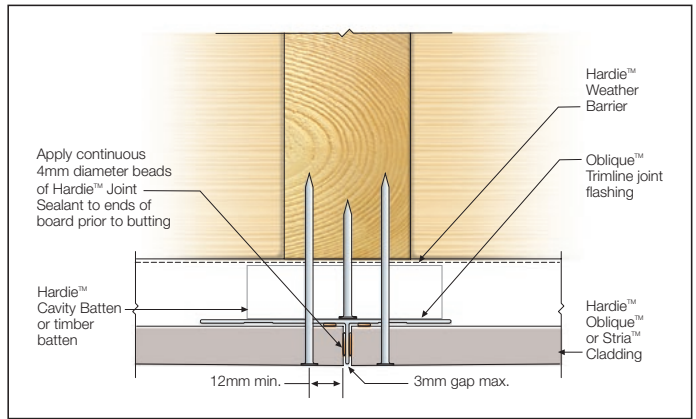

FIGURE 10 VERTICAL JOINT DETAIL

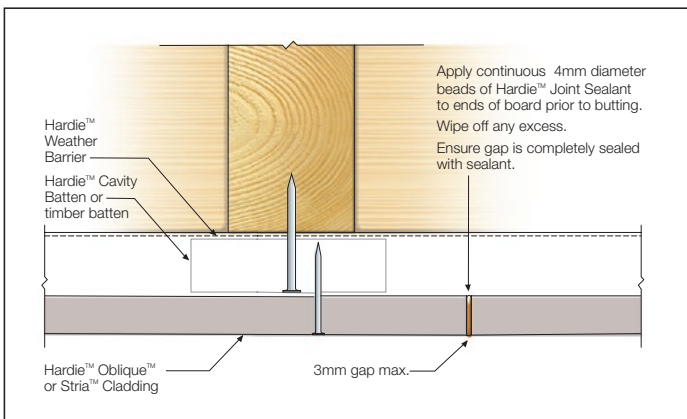

FIGURE 11 OFF-STUD JOINT

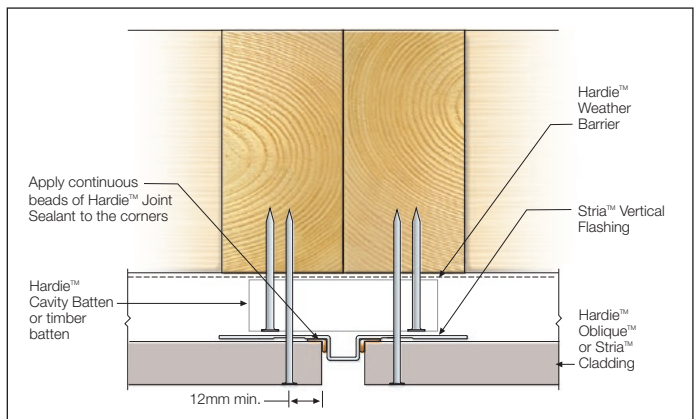

FIGURE 12 VERTICAL JOINT USING STRIA™ VERTICAL FLASHING STOP

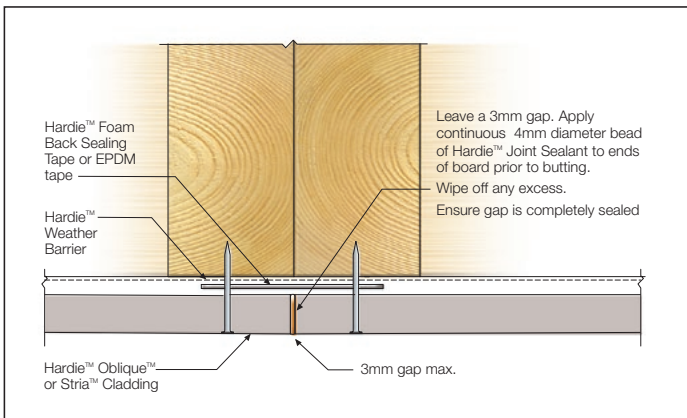

FIGURE 13 HARDIE™ FOAM BACK SEALING TAPE DETAIL (DIRECT TO FRAME ONLY)

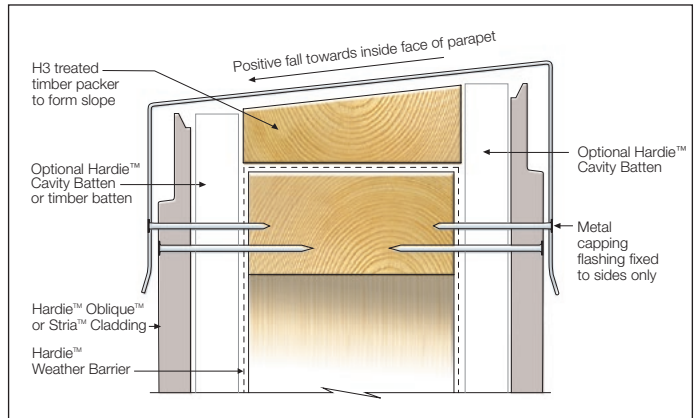

FIGURE 14 PARAPET DETAIL

# WINDOW DETAILS

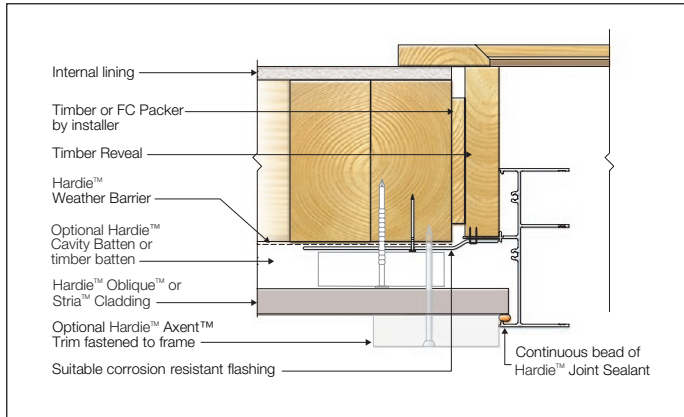

FIGURE 15 WINDOW JAMB - TRIM

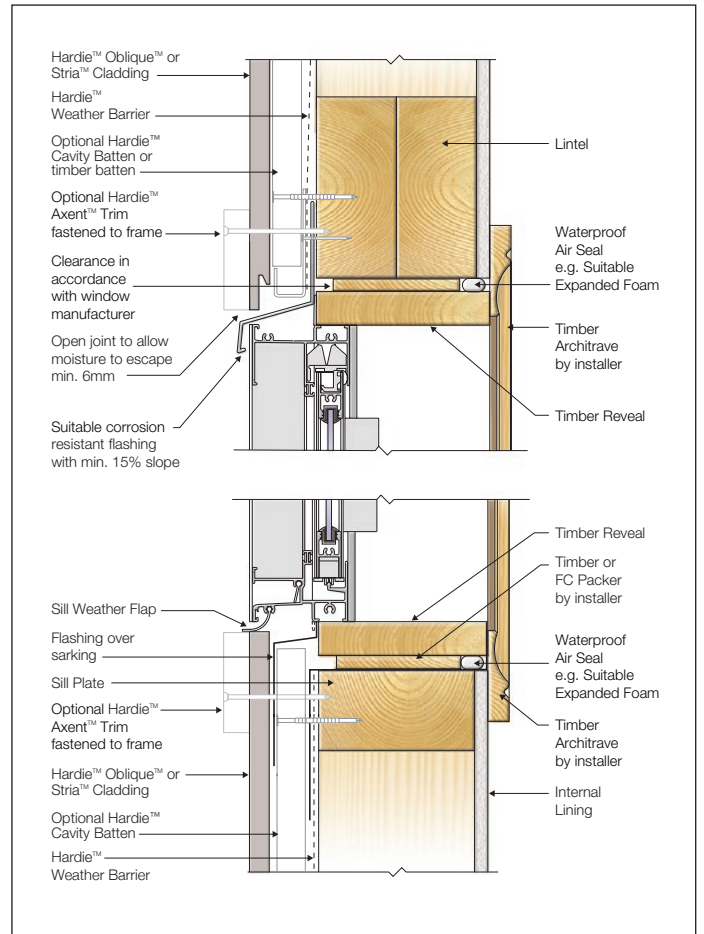

FIGURE 16 WINDOW HEAD AND SILL - TRIM

# 9 Construction Details - Vertical Board Orientation

## JUNCTION DETAILS

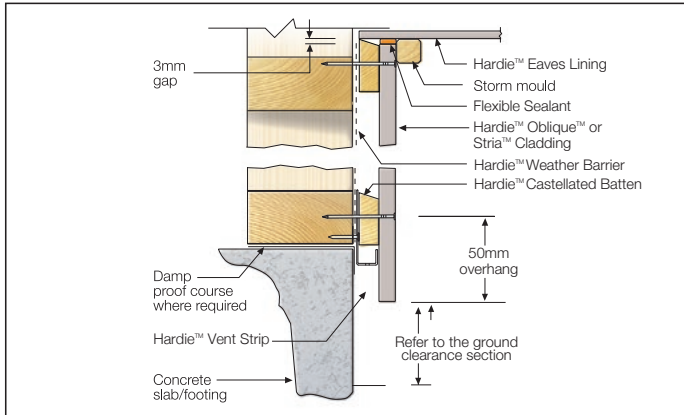

FIGURE 17 SLAB/EAVE JUNCTION DETAIL

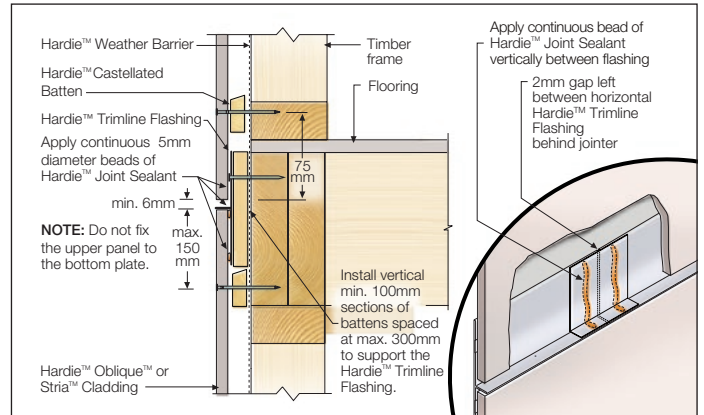

FIGURE 18 UPPER FLOOR JUNCTION

## INTERNAL CORNER DETAILS

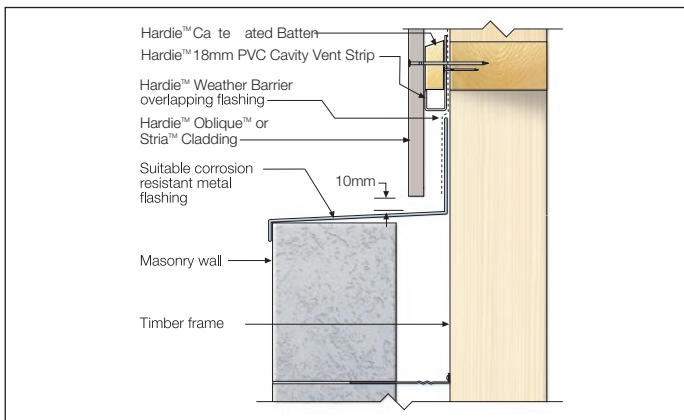

FIGURE 19 HORIZONTAL JUNCTION

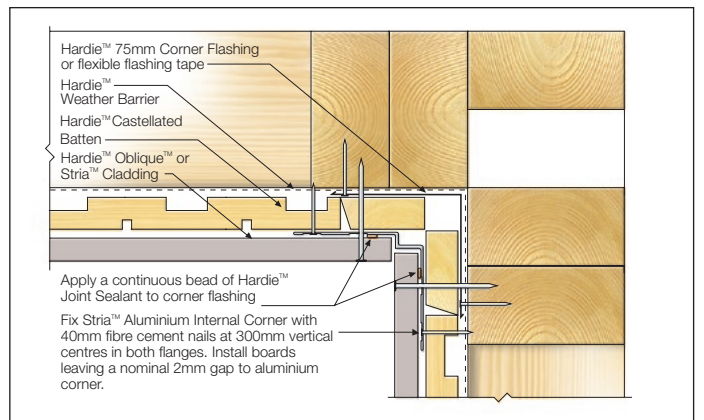

FIGURE 20 INTERNAL CORNER

## EXTERNAL CORNER DETAILS

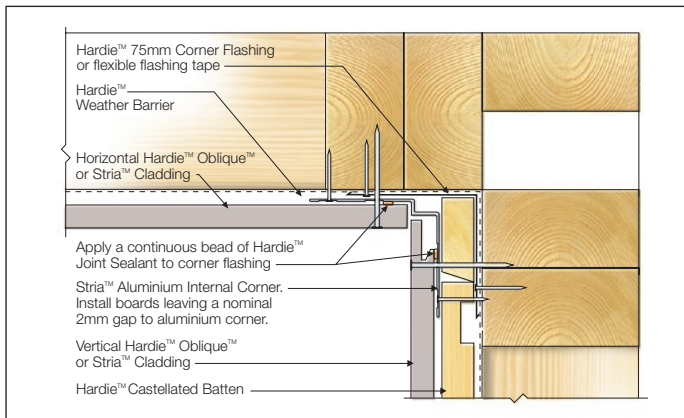

FIGURE 21 INTERNAL CORNER BETWEEN VERTICAL AND HORIZONTALLY ORIENTED BOARDS

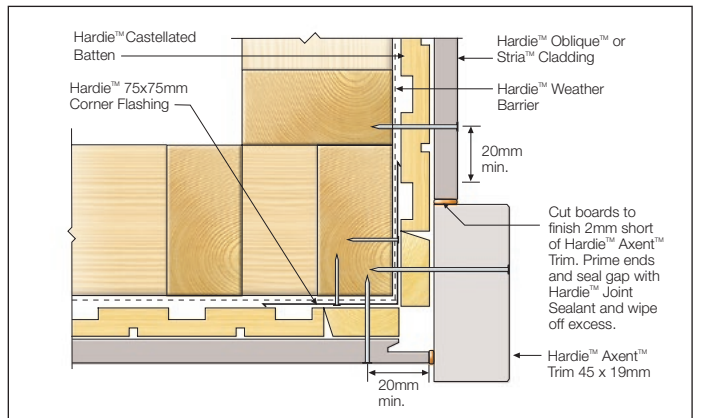

FIGURE 22 EXTERNAL TRIM CORNER

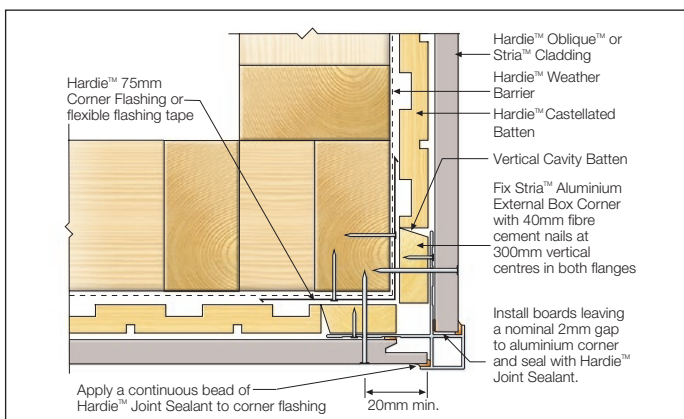

FIGURE 23 EXTERNAL BOX CORNER

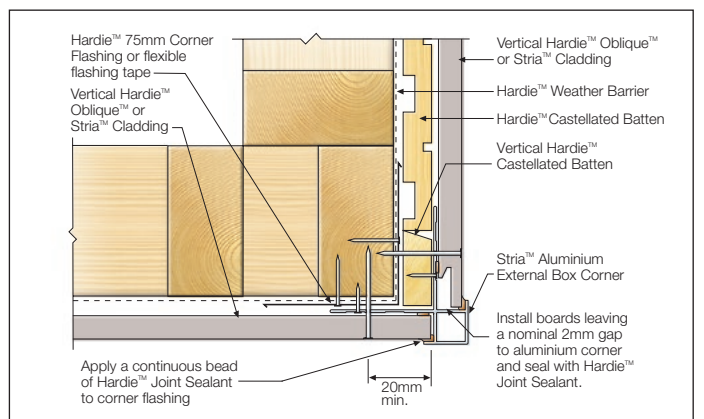

FIGURE 24 EXTERNAL CORNER BETWEEN VERTICAL AND HORIZONTALLY ORIENTED BOARDS

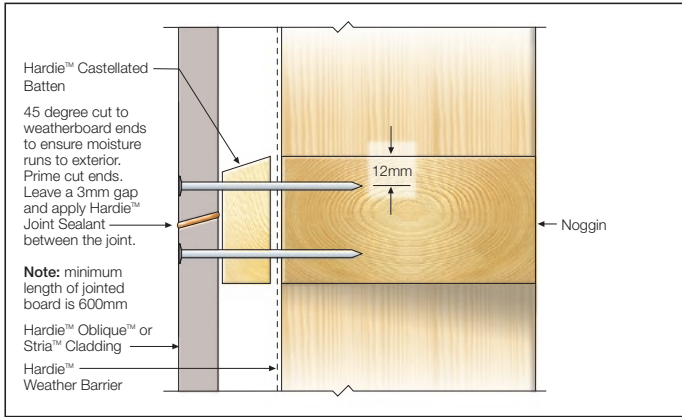

FIGURE 25 VERTICAL BUTT JOINT DETAIL

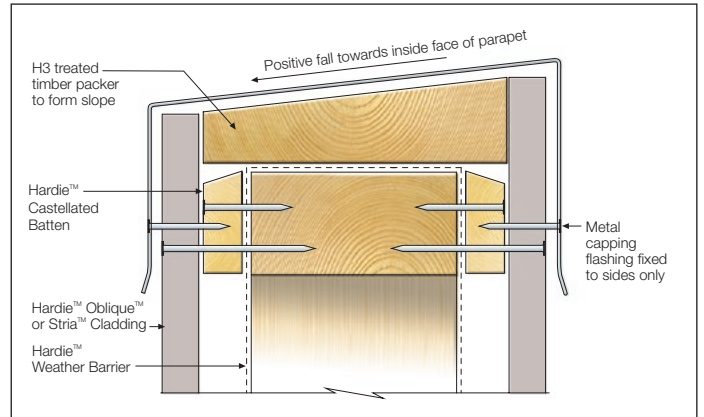

FIGURE 26 PARAPET DETAIL

## WINDOW DETAILS

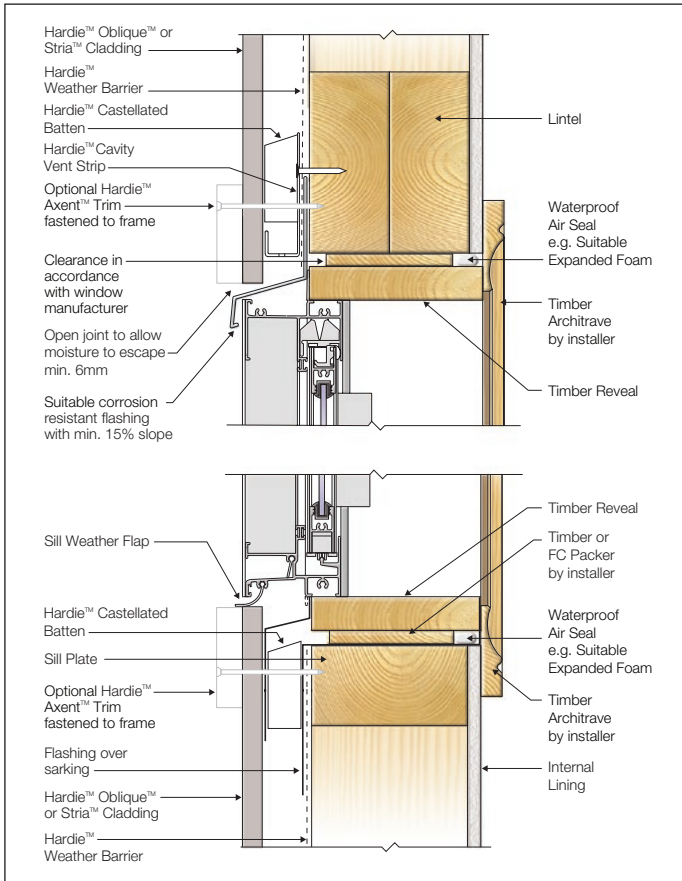

FIGURE 27 WINDOW HEAD AND SILL - TRIM

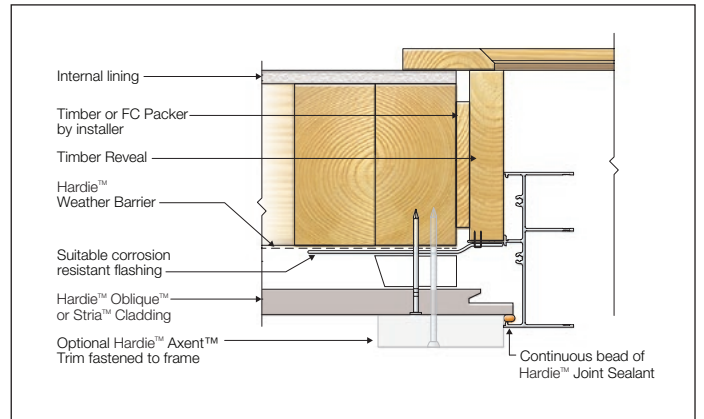

FIGURE 28 WINDOW JAMB - TRIM

# 10 Finishes and Maintenance

## SURFACE PREPARATION

Ensure the surface is dry, clean and any overdriven nails are patched in accordance with this specification.

Any slightly overdriven brad nails (1mm max.) may be repaired using a suitable external grade filling agent. All patches must be sanded and primed before applying the paint.

### Sealants

James Hardie recommends the use of Hardie™ Joint Sealant, which is a paintable polyurethane sealant. Use of alternative sealants must comply with manufacturer's instructions. Sealants, if coated, must be compatible with the paint system.

## PAINTING

Panels must be finished within 3 months of being fixed with the recommended coating set out in Table 4 and the project specification. In areas within 1km of a coastal area or corrosive environment, panels must be coated immediately after fixing sheets to minimise contamination build up on the heads of the fasteners.

## MAINTENANCE

The extent and nature of maintenance will depend on the geographical location and exposure of the building. As a guide, it is recommended that basic normal maintenance tasks shall include but not be limited to:

- Washing down exterior surfaces every 6-12 months\*
- Periodic inspections should be made to ensure fasteners are adequately securing the sheets to framing.
- Re-applying of exterior protective finishes\*
- Maintaining the exterior envelope and connections including joints, penetrations, flashings and sealants that may provide a means of moisture entry beyond the exterior cladding.
- Cleaning out gutters, blocked pipes and overflows as required.
- Pruning back vegetation that is close to or touching the building.

\*Refer to your paint manufacturer for washing down and recoating requirements related to paint performance.

# 11 Product Information

## PRODUCT INFORMATION

### Material

The basic composition of Hardie™ building products is Portland cement, ground sand, cellulose fibre, water and proprietary additives.

Hardie™ building products are manufactured to AS/NZS 2908.2 'Cellulose-Cement Products-Flat Sheet'. These are also compliant with equivalent standard ISO 8336 'Fibre-cement flat sheets - Product specification and test methods'. For product classification refer to the relevant Physical Properties Data Sheet.

### Durability

#### Resistance to Moisture/Rotting

Hardie™ Oblique™ and Stria™ Cladding have demonstrated resistance to permanent moisture induced deterioration (rotting) by passing the following tests in accordance with AS/NZS 2908.2:

- Water permeability (Clause 8.2.2)
- Heat rain (Clause 6.5)
- Warm water (Clause 8.2.4)
- Soak dry (Clause 8.2.5)

#### Resistance to fire

The Hardie™ Oblique™ and Stria™ Cladding are suitable where non-combustible materials are required in accordance with C1.9 of the National Construction Code (NCC).

Hardie™ building products have been tested by CSIRO in accordance with AS/NZS 3837 and are classified as conforming to Group 1 material (highest and best result possible), with an average specific extinction area far lower than the permissible 250m<sup>2</sup>/kg, as referenced in Specification C1.10a of the NCC 2019.1.

#### Resistance to Termite Attack

Based on testing completed by CSIRO Division of Forest Products and Ensis Australia, Hardie™ building products have demonstrated resistance to termite attack.

### Alpine Regions

In regions subject to freeze/thaw conditions, all James Hardie fibre cement external cladding must be installed and painted in the warmer months of the year where the temperature does not create freeze and thaw conditions or paint issues. The cladding must be painted immediately after installation. In addition, fibre cement cladding must not be in direct contact with snow and/or ice build up for extended periods, e.g. external walls in alpine regions subject to snow drifts over winter.

Furthermore, a reputable paint manufacturer must be consulted in regards to a suitable product, specifications and warranty. The paint application must not be carried out if the air temperature or the substrate temperature is outside the paint manufacturer's recommendation including the specified drying temperature range

Hardie™ external cladding products are tested for resistance to frost in accordance with AS/NZS 2908.2 Clause 8.2.3.







**For information and advice  
call 13 11 03 | [jameshardie.com.au](https://jameshardie.com.au)**

**Australia March 2023**



© 2023 James Hardie Australia Pty Ltd ABN 12 084 635 558  
™ and © denote a trademark or registered mark owned by James Hardie Technology Limited.  
Codemark®, Colorbond®, Hitachi, Makita® and Hilti are trademarks or registered trademarks of  
their respective owners and are not owned by James Hardie Technology Limited.