

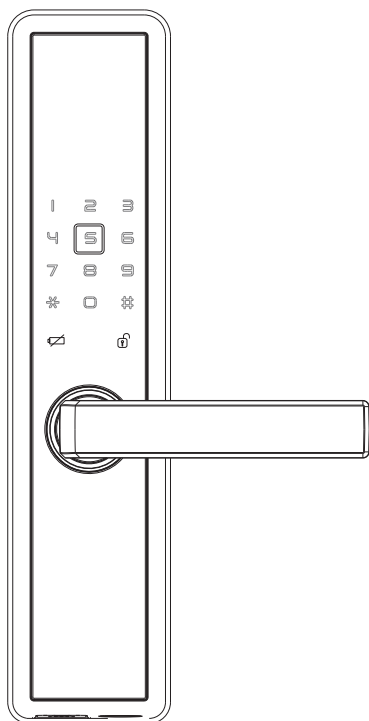

# User's Manual

---

## M-series Lock



Dear User,

Thank you for purchasing a dormakaba smart lock.  
Before using the smart lock, please read this manual and keep it safe for future reference.

This manual represents the complete range of operating conditions for the M5 smart lock series. Software and hardware configurations are subject to the packaging list inside the product box.

Images used in this manual are for reference only and may not resemble the actual lock or user interface.

dormakaba will not bear any liabilities from any losses caused by improper operations of the lock according to the smart lock user manual. dormakaba may reject warranty claims if the instructions have not been followed.

## 1 How to Use

Admin PIN Code Setting	4
How to Enter the Menu	4
Factory Reset	5
Delete All User's Information	5
Menu Flow Chart	6
Card Registration	8
PIN Code Registration	9
Unlocking Methods	9
Bluetooth APP Downloading	11
Enable Bluetooth APP	12
Bind Device	12
Device Management	13
View Device Information	14
Bluetooth Key Sharing	15
Check Messages	16
Language Setting	16
Bluetooth APP Function Preview	17
Lock the Door from Inside	19
Visitor Mode	19
Passage Mode	20
Privacy Mode	20
User's Permissions Assignment Table	21
User's Permissions Level	21
Product Function Configurations	22
Alarm Function	23

<b>2</b>	<b>Emergency Use</b>	
	How to Replace Batteries	24
	Precautions for Using Batteries	24
	Use of Emergency Power Supply	24
<b>3</b>	<b>Safety Regulations</b>	25
<b>4</b>	<b>Troubleshooting</b>	26
	Warranty Service	28
	Warranty Card	29
	Service Records Table	30
	Certificate of Approval	31
	Installation Receipt	32

## Admin PIN Code Setting

Choose a New P/N Code (Must Be Between 6-12 Digits)

1 Remove the battery cover

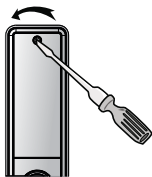

2 Press the [M] button for about 10 seconds until you hear the message "Please Input Pin Code"

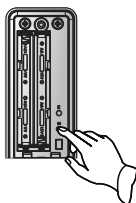

3 Input a new 6-12 digit PIN code and press [#]



4 Input the PIN code again and press [#]

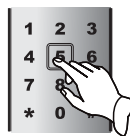

**WARNING:** The default admin PIN code is: 00123456.

- After the installation and commissioning of the door lock, please change the default admin PIN code as soon as possible.

**NOTE:** The PIN code consists of 6-12 random digits.

- The admin PIN code is used to set the functions only. This code cannot be used to open the door.

## How to Enter the Menu

1 By Admin PIN Code



1. Wake up the keypad.
2. Input PIN code and press [#].

2 By Admin Card



1. Swipe the card in front of the reader.

**NOTE:**

- Only the admin PIN code and admin card have admin functionality, but cannot be used to open the door.
- This user's manual introduces the operation methods of the products only and does not list the product hardware and software configurations. Functionality and design of the products are subject to change without prior notice.

# 1 How to Use

## Factory Reset

1 Remove the battery cover

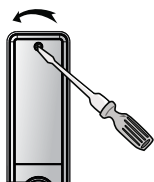

2 Simultaneously press the [M] and [E] buttons on rear lock for 5 seconds

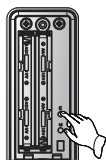

3 Input the 6-12 digit admin PIN code and press [#]



4 Select the language based on voice guide and press [#]



### NOTE:

- After resetting successfully, the lock will restore to its default setting.
- After factory reset, the registered cards, remote controls and Bluetooth users will be cleared and the database bank only contains the default admin PIN code: 00123456.

## Delete All User's Information

1 Remove the battery

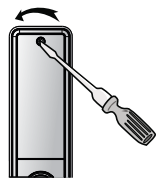

2 Press [E] button for about 10 seconds

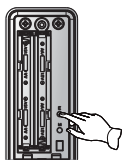

3 Input the 6-12 digit admin PIN code and press [#]



### NOTE:

- All users' PIN codes and cards will no longer exist after successfully deleting all user information.
- The admin PIN code will not be affected by deleting all users' information.

## Menu Flow Chart

### 1 PIN Code Management (Input Menu Number and Press [#] to Manage)

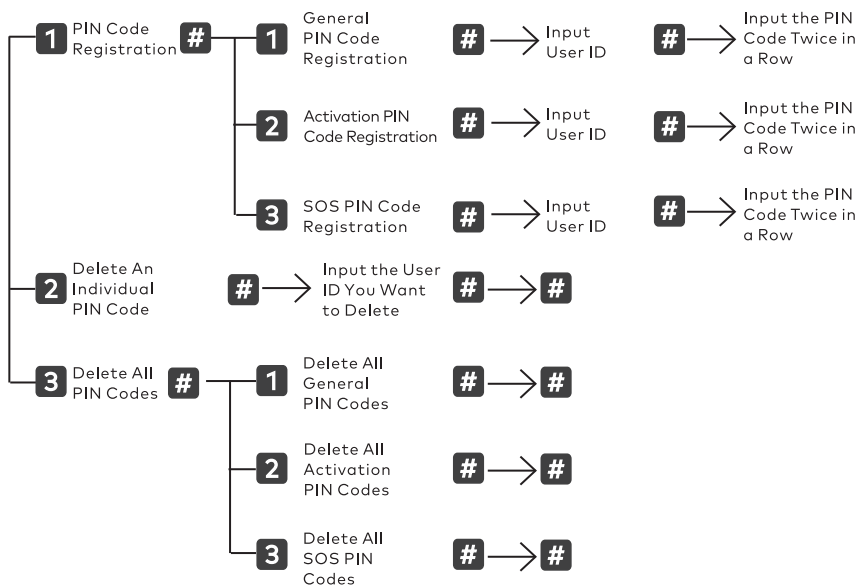

#### NOTE:

- General PIN code user ID:01-07, activation PIN code user ID:08, SOS PIN user ID: 09 and the admin PIN code user ID:00. The activation PIN code is used for remote unlocking by Zigbee APP, and the default code is the last 6 digits of the lock serial number.
- The PIN code consists 6-12 digits. You can follow the voice guide to input the PIN code. Any numbers added before (after) the correct PIN code called scramble code, the PIN code and scramble code can not exceed 32 digits.
- SOS PIN code and SOS user are available only when the wireless communication function is on.

## Menu Flow Chart

### 2 Card Management (Input Menu Number and Press [#] to Manage)

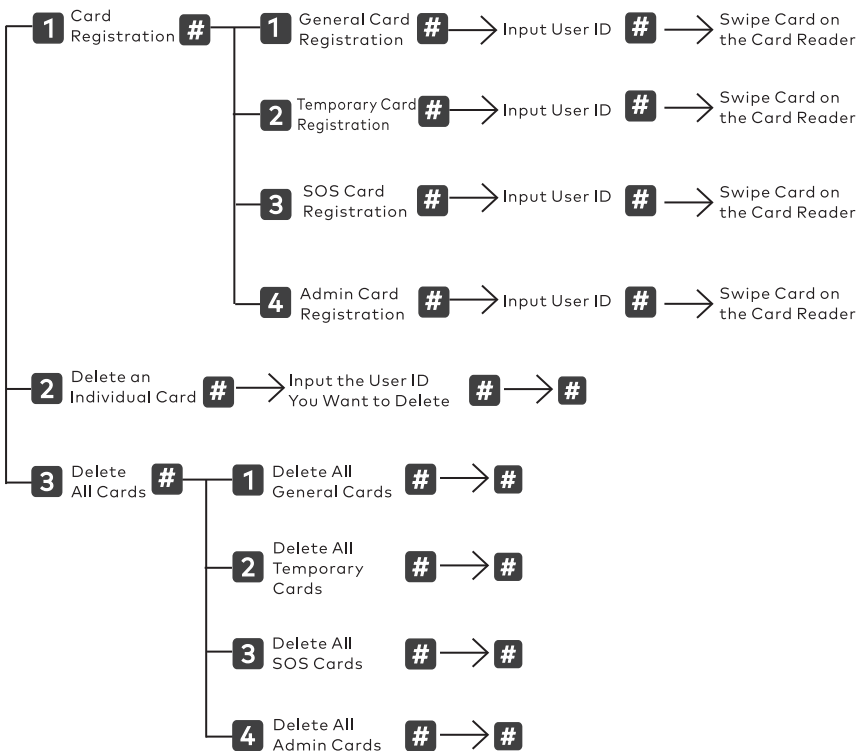

#### NOTE:

- SOS user and SOS card are available only when wireless communication function is on.
- General card user ID:10-79, temporary card user ID: 80-89, SOS card user ID:90-99 and the admin card user ID:00-09. Please swipe the card in front of the reader. The distance between them should be within 10mm.



## Menu Flow Chart

### 3 System Setting (Input Menu Number and Press [#] to Manage)

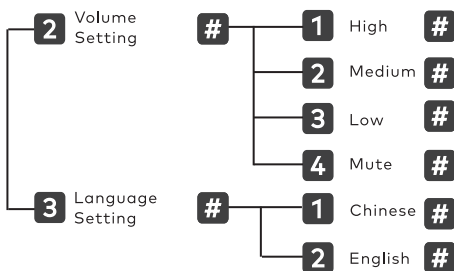

## Card Registration

1 Enter the menu



2 Press [2] and [#]



3 Press [1] and [#]



4 Press [1] / [2], [3] / [4] and [#]



5 Input 2-digit user ID and [#]



6 Swipe the card once

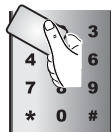

Note  
1-General  
2-Temporary  
3-SOS  
4-Admin

# 1 How to Use

## PIN Code Registration

- 1 Enter the menu



- 2 Press [3] and [#]



- 3 Press [1] and [#]



- 4 Press [1] / [2] [3] and [#]



- 5 Input 2-digit user ID and [#]



- 6 Input the PIN code twice and [#]



Note 1-General  
2-Activation  
3-SOS

## Unlocking Methods

- 1 Unlocking via PIN Code



1. Wake up the keyboard.
2. Input 6-12 digit PIN code and press [#].
3. Press down the handle to open the door.

- 2 Unlocking via Card



1. Swipe the registered card.
2. Press down the handle to open the door.

## Unlocking Methods

### 3 Unlocking via Mechanical Key



1. Insert the key and rotate to the end.
2. Press down the handle to open the door.

#### NOTE:

- The alarm (check page 23) may be triggered if the mechanical key is used to unlock.
- The lock is made of class-C mechanical anti-theft cylinder with high security. Please keep the mechanical key in a safe place for future usage.

### 4 Unlocking via Interior Handle

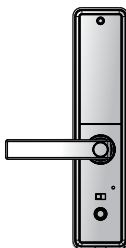

- For the lock with safety handle (optional): Press the safety button and press down the handle to open the door.
- For the lock without safety handle: Press down the handle to open the door.

### 5 Bluetooth Unlocking (optional)



1. Shake to Unlock:  
Enter the device interface, shake the mobile phone and the smart lock will be unlocked successfully.
2. Single Touch to Unlock via APP:  
Enter the device interface, click the unlocking icon  to unlock.

#### NOTE:

Shake to unlock will not function if more than one device is within range and connected to the APP at the same time.

## Bluetooth APP Downloading (Optional)



Download the APP  
installation package

Smart Lock APP hereinafter will be  
referred to as the Bluetooth APP.

1. Enable your mobile to scan QR Code above to download APP Installation Package.
2. After entering the downloading interface, select your mobile including Google Play, APP Store, Huawei and Xiaomi.
3. Following the onscreen instruction "Open With Browser", click any browser in your mobile screen to download.
4. Enable the APP and login after successfully downloading and installing.

## Enable Bluetooth APP

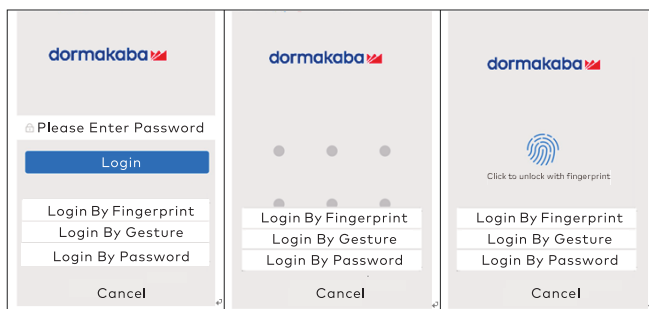

Switch to Password Login

Switch to Gesture Login

Switch to Fingerprint Login

Enable the APP and enter the login interface. Then click "Change the Login Model" and authenticate user by password, gesture or fingerprint; ensuring the Bluetooth function in phone is turned on. You can enter device management automatically after successful login.

# 1 How to Use

## NOTE:

- Login by fingerprint must be supported by mobile, which is equipped with fingerprint sensor and running Android 6.0 and IOS 8.0 or above.
- If the wrong password is entered 3 times, the APP will be locked for 30 seconds (in an Android system) and in an IOS system, another login model must be employed.

## Bind Device

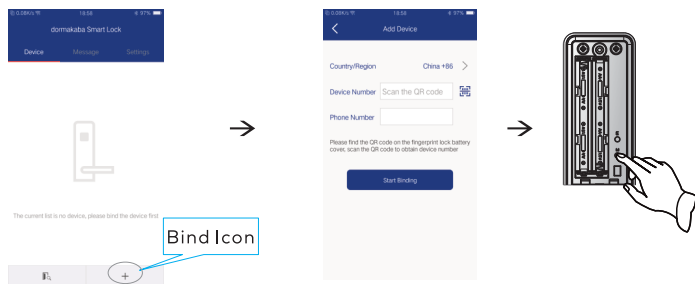

1. Enter the device interface and click the binding icon + on the bottom.
2. On the device binding interface, click the code scanning icon  scan the QR code on the battery cover and enter the mobile phone number and click "Start Binding".
3. When the APP sending request of binding and the lock prompts "In Operation", press the "M" button located at the back of the lock body.
4. Choose the default name or input a new name, following the on screen instruction "Please Name This Device" and click the "Save" button to confirm.

## Device Management

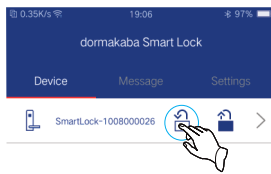
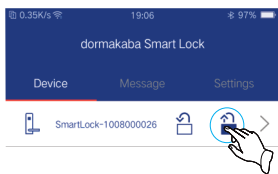

### Unlocking:

Enter management interface and click the unlocking icon .  
The smart lock is unlocked.

### Locking:

Enter management interface and click the locking icon .  
The smart lock is locked.

### Refresh Device Information:

Enter device management interface and press one binding device until a selection menu pops up. Click "Refresh Device Information" to synchronise the data in APP and smart lock system.

### Unbind the Device:

Enter device management interface and press one binding device until a selection menu pops up. Click "Unbind the Device" and then click "OK" to delete the device from the APP device list.

### Shake to Unlock:

Enter "Device Information" and shake your mobile to unlock.

### NOTE:

To enable unlocking by shaking the mobile phone, the distance between the mobile phone and the lock shall be within 10 m and they are connected successfully.

## View Device Information

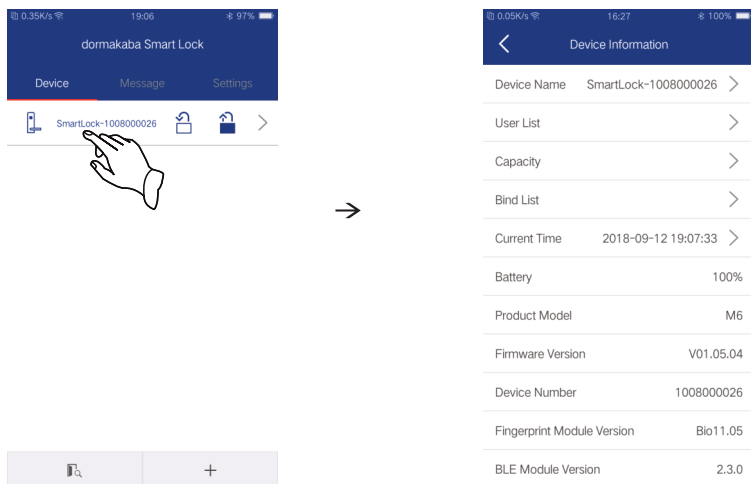

1. Click the binding device after bound with the smart lock successfully.
2. Enter "Device Information" interface, you can view or change the lock name and view the user list, capacity, bind list, current time, battery, product model, firmware version, device number, date of manufacture, module version and BLE module version.

### NOTE:

Not all the datum can be displayed on one full page. Please scroll down the page to view all of the information.

### Synchronise Time:

Enter "Device Information" interface, click "Current Time" to finish time synchronisation.

### Binding List:

Enter "Device Information" interface and click "Bind List" to display the mobiles bound with the smart lock. Click the deleting icon (⊗) on the right of the user you want to delete and then click "Confirm" to confirm the operation.

### NOTE:

The first mobile successfully bound with the smart lock is the administrator. Only the administrator has the right to synchronise the time and unbind other devices on the bind list.

## Bluetooth Key Sharing

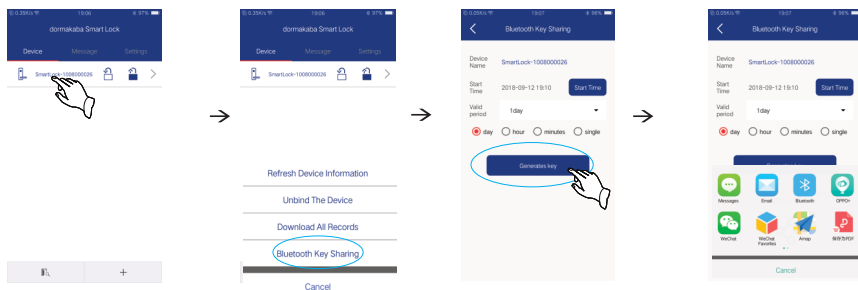

1. Enter the device management interface, long press the connected device, pop up a selection menu and click "Bluetooth Key Sharing".
2. Choose the start date, time and valid period and click "Generates Key". Click the sharing icon  to share the new key to other users via email, WeChat, QQ etc. The receiver can input the key to open the door.

### NOTE:

1. Only the administrator is equipped with "Bluetooth Key Sharing" on the management interface.
2. When a single valid term is selected, only 10 Bluetooth keys can be shared. 10+ keys can be shared, however the door cannot be opened.
3. The shared keys will be valid for 24 hours, if you select other time ranges, the Bluetooth key sharing will not be restricted.



## Check Messages

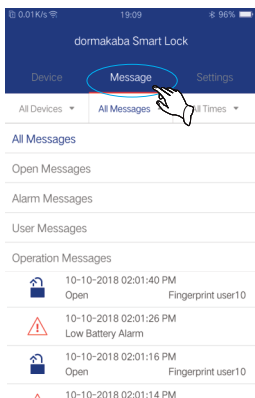

1. Click "All Devices" after entering "Message" Interface.
2. Select a device name, click "All Messages" to unfold options including "All Messages", "Open Messages", "User Messages", "Operation Messages" and "Alarm Messages". You can click "All Times" to unfold operations including "All Times", "Recent 1 Day", "Recent 7 Days", "Recent 15 Days", "Recent 30 Days" and "Custom Time Zones"
3. Select the required message type or time zone to view.

### Synchronise Message:

In the "Message" interface, press lock icon until a dialogue box appears on the bottom of the screen and click "Synchronise" to keep the message on the APP in line with the smart lock system.

### NOTE:



- In the "Message" interface, press the unlock/lock icon until the dialogue box appears at the bottom of the screen. Messages can be selected and deleted using the dialogue box.
- Android users can operate the APP following the above instructions. Please note that the operation system is slightly different for IOS users. The mobile APP shall prevail in actual operation and menu.

## Language Setting

1. Click settings on your mobile and enter the "Language Interface" and choose your preferred language.
2. Enable the APP to confirm that the device, message and setting interfaces have been synchronised.

## Bluetooth APP Function Preview

After installing the APP onto your mobile successfully, enable your mobile Bluetooth, login, and bind your mobile with the lock then enter lock management.

Device Management Interface	Unlock				
	Lock				
	Refresh Device Information	Press a Device Name for Several Seconds	Refresh Device Information		
	Unbind Device	Press a Device Name for Several Seconds	Unbind Device	Click "Confirm"	
	Download All Records	Press a Device Name for Several Seconds	Download All Records		
	Bluetooth Key Sharing	Press a Device Name for Several Seconds	Share Bluetooth Key	Choose Start Date, Time and Valid Period	Generate Key and Click Icon 
	View User Information	Click a Binding Device	Device Information	View or Change Lock Name, User List, Current Time, Capacity, Electricity Capacity, Product Mode etc.	
	Shake to Unlock	Click a Bound Device	Device Information	Shake to Unlock	

## Bluetooth APP Function Preview

Message Interface	View Message	Click "All Device" to Choose a Device	Choose Message Type Including: <ul style="list-style-type: none"> <li>- All Messages</li> <li>- Open Messages</li> <li>- User Messages</li> <li>- Operation Messages and</li> <li>- Alarm Messages</li> </ul>
			Choose Period Time Including: <ul style="list-style-type: none"> <li>- All Times</li> <li>- Recent 1 Day</li> <li>- Recent 7 Days</li> <li>- Recent 15 Days</li> <li>- Recent 30 Days and</li> <li>- Custom Time Zone</li> </ul>
Setting Interface	Click "Login Settings"	Switch Login Model and Change Settings	
	Click "Autosync"	Records in APP Changes in Accordance with Lock System	
	Click "Time Format"	Choose the Required Format	
	Click "Message Hints"	In the APP the Generated New Messages are Hint in Sound and Vibration, Enable/Sisenable Setting	
	Click "About Us"	Get Latest Version	

This flow chart only introduces how to manage locks through mobile. The APP shall be subject to actual operation and menu.

# 1 How to Use

## Lock the Door from Inside

### 1 Automatic Locking Mode



Press the switch button on the rear lock body to [LOCK] to enter automatic locking mode and the door will be automatically locked when the door is closed.

### 2 Passage Mode

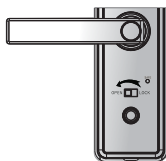

Press the switch button on the rear lock body to [OPEN] to enter passage mode and the door won't be automatically locked when the door is closed.

#### CAUTION:

- Press down the external handle to open the door on passage mode.
- Please be alert and watch out if the door is open.

## Visitor Mode

The visitor mode is enabled when a user enters a temporary password, card and digital key shared by Bluetooth for remote door unlocking.

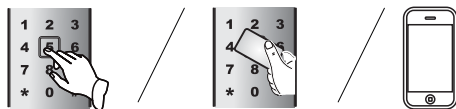

#### CAUTION:

- On visitor mode, user is unable to do factory reset, clear users, change admin PIN code or other operations.
- Except for the unlocking methods mentioned above, you can exit visitor mode by using other unlocking methods.

# 1 How to Use

## Passage Mode

- 1 Enter Passage Mode:  
Push the switch button on the rear lock body to [OPEN] end.



- 2 Exit Passage Mode:  
Push the switch button on the rear lock body to [LOCK] end.



### NOTE:

Lock will say "Passage Mode" every time the lock lever is pushed down, as well as when a code, card or the APP are used during this mode.

## Privacy Mode

- 1 Enter Privacy Mode:  
Push the switch button on the rear lock body to the [LOCK] position. Push the lever down and press the switch button at the same time until a voice message says "Privacy Mode" (the SAFE light indicator will flash for 2 seconds).

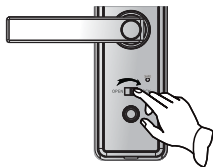

- 2 Exit Privacy Mode:  
Press the switch button to exit privacy mode. The SAFE indicator will flash for 2 seconds.

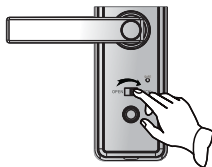

### NOTE:

- Privacy mode can only be set when the door is locked.
- Once the handle is pressed down or the deadlatch is released, the privacy mode will be cancelled automatically.
- On the privacy mode, only the switch button, interior handle and the mechanical key can work, and a "Privacy Mode" voice will be prompted when any other credential is used.

# 1 How to Use

## User's Permission Assignment Table

Item	Qty.	No.	Permission
Admin PIN Code	1 Group	00	All operations after entering the menu
General PIN Code	7 Group	01~07	Unlocking the door
Activation PIN Code	1 Group	08	Activate the lock and unlock the door with Zibgee APP
SOS PIN Code	1 Group	09	Unlocking the door
Admin Card	10 Pcs	00~09	All operations after entering the menu (except modifying the user of admin permission)
General Card	70 Pcs	10~79	Unlocking the door
Temporary Card	10 Pcs	80~89	Unlocking the door
SOS Card	10 Pcs	90~99	Unlocking
Bluetooth APP User	10 Pcs	00~09	All operations after device binding

## User's Permission Level

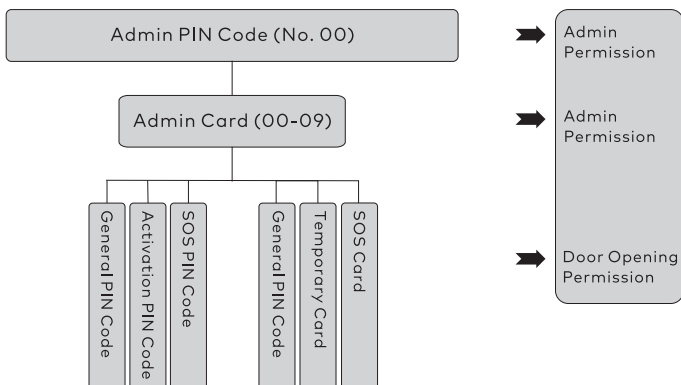

### Note

Admin user unable to open door

## Product Function Configurations

No.	Item	M5
2	PIN Code Capacity (Set)	10
3	Card Capacity (PCS)	100
4	Privacy Mode	✓
5	Passage Mode	✓
6	Fake Code Function	✓
7	Low Battery Alarm	✓
8	Break In and Tamper Alarm	✓
9	Keypad Lockout	✓
10	Voice Guide	✓
11	SOS Alarm (Optional)	⊙
12	Bluetooth APP (Optional)	⊙

### NOTE:

- Operation Frequency:  
BLE: 2402-2480MHZ  
RFID: 13.56MHZ
- Transmitted Power:  
BLE: 8dBm

## Alarm Function

### 1 Alarm Function

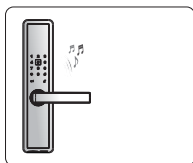

The red indicator will flash when the battery voltage is low and prompt low voltage when awake. In this case, please replace the batteries.

### 2 Keypad Lockout Alarm

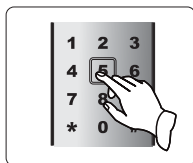

If the wrong PIN code is input 3 times, the lock will enter lockout mode automatically for about 15 minutes and you will hear "Keypad Locked" when you try to press any keys on the keypad during the lockout period. If wrong input times are not consecutive and not up to 3 times, the wrong inputs will be cleared automatically after 20 seconds.

### 3 Damage Alarm

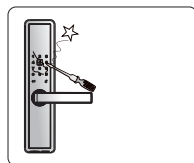

An alarm will be activated and will last for 30 seconds if an outsider tries to break into the house by damaging the door lock. The red indicator will flash at the same time.

### 4 Keypad Unlocking

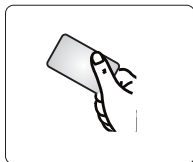

Open the door by any correct method (except PIN code and mechanical key) or remove battery to unlock keypad.

### 5 Locking Status Change

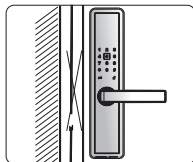

If the sensor inside the auto-dead bolt mortise detects the locking status signal over 5s, but the signal was interrupted, the alarm will show for 30s and the keypad lights will come on. A successful unlocking via admin user or wireless user will stop the alarm.

### 6 SOS Alarm

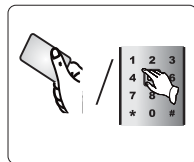

When the user is subject to duress, open the door by card or PIN code of number 90-99 to enable duress alarm.

#### NOTE:

Mechanical key unlocking may also trigger alarm, and it will last for 30 seconds.



# 2 Emergency Use

## How to Replace Batteries

1 Open the battery cover

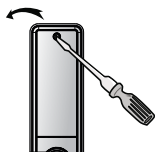

2 Remove the used batteries



3 Insert new batteries



4 Put on the battery cover



## Precautions for Using Batteries

1 Do not mix.  
Do not mix used and new batteries or batteries of different models.

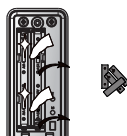

2 When to replace with new batteries.  
Please replace used batteries with new ones when you hear the low battery alarm and see the red indicator flashing.

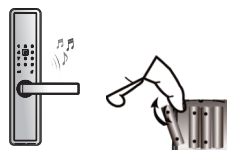

### NOTE:

No registered information will be affected during and after replacing batteries. Please also be aware that after re-powering the lock with the BLE function, the time will be synchronised.

## Use of Emergency Power Supply

If the batteries are depleted, you can plug a 9V square battery or type-C adaptor into the interface at the lower part of the front lock body, then open the door by any method.

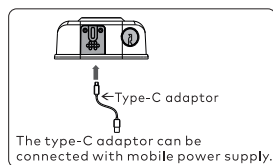
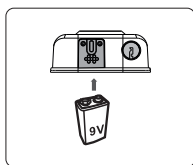

### NOTE:

Power supply won't affect unlocking by mechanical key.

# 3 Safety Regulations



Consult a qualified professional for installation or relocation.

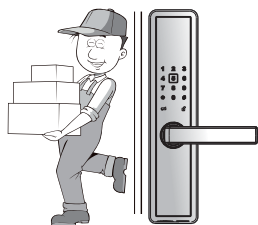

Do not install the lock where it is exposed to rainwater as this may cause the product to malfunction.



Do not clean the product with water which may cause circuit failure.



Do not hang any objects on the handle.



Do not disassemble, reassemble or repair the lock by yourself. This may cause damage or malfunction to the lock and void your warranty.

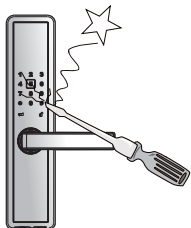

Keep the lock away from corrosive substances to avoid damage the protective layer of the lock.



# 4 Troubleshooting

Type	Symptoms	Solution
Basic Operations	The door cannot be opened by mechanical key.	<ol style="list-style-type: none"> <li>1. Check if the mechanical key is correct.</li> <li>2. Ask a professional to check the mortice, cylinder and clutch and replace if there are any problems.</li> </ol>
	The door cannot be opened with the PIN code or card authentication and the green indicator is on.	<ol style="list-style-type: none"> <li>1. Ask a professional to check that the cylinder wire and connecting wire are installed properly.</li> <li>2. Check that the motor works normally.</li> </ol>
Installation	Door lock is always open or closed and is not working normally.	<ol style="list-style-type: none"> <li>1. Ask a professional to check the clutch.</li> <li>2. Check that the handle is equipped with the square shaft spring.</li> </ol>
	Front handle idles and the door cannot be opened.	<ol style="list-style-type: none"> <li>1. Return the handle to the horizontal position and re-authenticate.</li> <li>2. Check that the handle is equipped with square shaft spring.</li> </ol>
	The dead bolt doesn't completely engage when rotating the front handle.	<ol style="list-style-type: none"> <li>1. Check if the greased parts of the cylinder are contaminated with dust or if the cylinder is clamped by the front and back lock connecting cable.</li> <li>2. Check if the top and bottom rod is loose.</li> </ol>
	Touch keys do not respond.	<ol style="list-style-type: none"> <li>1. Check the battery power or if the positive pole and negative pole are reversed.</li> <li>2. Open the door by the mechanical key, and ask a professional to check if the connecting cable of the front and back lock is loose.</li> </ol>
	Keypad is locked and the door can't be opened.	<ol style="list-style-type: none"> <li>1. Operate the keypad after 15 minutes.</li> <li>2. Open the door by card.</li> </ol>
Bluetooth Function	Failed to connect with Bluetooth APP.	<ol style="list-style-type: none"> <li>1. Please ensure that Bluetooth on your phone is on.</li> <li>2. Please check that Bluetooth in lockset is on.</li> </ol>

Type	Symptoms	Solution
Bluetooth Function	Failed to connect with Bluetooth APP.	<ol style="list-style-type: none"><li>3. Please check whether the distance between mobile phone and lock is beyond connection distance (the best performance distance between the mobile phone and the door lock is within the range of visibility and connection distance may vary from mobile phone models and door lock installation environment).</li><li>4. If there is still no connection, please check the compatibility of your smart phone. Android should be 5.0 and IOS should be 8.0 or above.</li></ol>

## Warranty and Service of dormakaba (Door Lock)

Thank you for purchasing a dormakaba smart lock. dormakaba provide warranty services for our door lock products. To protect your rights, please read the following guarantee clauses carefully.

1. We provide one year free warranty from the date of purchase for the door lock if it is purchased from our authorized sales channels and is used only according to these instructions.
2. We do not provide warranty services for the products bought from non-authorized dealers, regardless of the "dormakaba" branding.
3. Bar code is affixed on the warranty card and the product. Please make sure that the bar code is intact when you purchase our lock. Please retain your invoice as proof of purchase.
4. After the lock is installed, please request the installer fill out the installation receipt on the service card. The seller will register the product information according to the receipt. The warranty card and invoice are required for warranty service.
5. Please contact the agent that you purchased the product from for warranty and support services.
6. Other cases are not covered by warranty:
  - The warranty has expired;
  - The product model and bar code on the Warranty Card does not match the product;
  - The warranty card or bar code is amended without permission;
  - The product was installed by unqualified personnel;
  - The product was disassembled or modified without permission;
  - Damage caused by force majeure (earthquake, fire, flood etc.).
7. The following terms and conditions relate to the warranty of dormakaba products purchased within Australia and New Zealand ONLY.

Our goods come with guarantees that cannot be excluded under the Australian Consumer Law. You are entitled to a replacement or refund for a major failure and compensation for any other reasonably foreseeable loss or damage. You are also entitled to have the goods repaired or replaced if the goods fail to be of acceptable quality.

Please refer to our official website or official WeChat platform, for more information of the warranty clauses.

## Warranty Card of dormakaba (Door Lock)

Client Name:	
Telephone:	
Installation Address:	

Product Model:	
Cylinder Model:	
Barcode:	Please paste barcode here
Date of Purchase:	
Date of Installation:	

Dealer:	
Address:	
Telephone:	
Stamp:	

## Service Records Table

No.	Date	Symptoms	Maintenance Unit	Technician
1				
2				
3				
4				
5				
6				

Barcode (for After Sales Service):

**IMPORTANT:**

To ensure your legal rights, please secure your Warranty Card and any other relevant purchase credentials safely as any alterations and/or tearing will invalidate this documentation.

# Certificate of Approval

dormakaba 

---

# 合格证

CERTIFICATE OF APPROVAL

---

质量检查  
Quality Control

---

出厂日期  
Manufacture Date

---

多玛凯拔门控系统有限公司  
dormakaba China Ltd.

## TIPS:

1. Before installation, please ensure the product model matches your door and authorize our service unit for installation and debugging.
2. Keep the product away from organic solvents and corrosive chemicals and avoid exposing to strong radiation in order to avoid corrosion and oxidation.
3. Please refer to the User's Guide or Manual for correct use and maintenance. Take out the batteries and buy an emergency battery if the product won't be used for a long time.



# Installation Receipt of dormakaba (Door Lock)

Client Name:	Tel:
Installation Address:	Product Model:
	Mortice Model:
Dealer:	Date of Purchase:
	Dealer's Tel:
Installation Unit:	Date of Installation:
	Installation Unit Tel:
Barcode (Please paste barcode here):	

TO BE COMPLETED BY USER:			
Installation:	Check before installation	<input type="checkbox"/> YES	<input type="checkbox"/> NO
	Clean up the site after installation	<input type="checkbox"/> YES	<input type="checkbox"/> NO
User Guidance:	Master the setting of admin PIN code	<input type="checkbox"/> YES	<input type="checkbox"/> NO
	Master the setting MF card and PIN code	<input type="checkbox"/> YES	<input type="checkbox"/> NO
	Understand the daily maintenance	<input type="checkbox"/> YES	<input type="checkbox"/> NO

Please Rate Our Services:  GOOD  FAIR  POOR

I have finished the installation, debug and guidance for the user according to technical requirements and the operation is normal.	The installation unit has been installed, debugged and instructed as required and the operation is normal.
Installed By:	Customer Signature:

To guarantee your rights and interests, please supervise and fill relevant information of the service card. The installer will mail back the installation receipts to our company.

