



USER MANUAL E-BIKE (PEDELEC)

COMMUTER eBIKE

Contents

1. Introduction	4	Product Specifications	
2. General Information	5	(TFT LCD Display)	30
3. Legal Details	6	1. Product Name	30
4. Local Regulations	6	2. Suppliers	30
5. Intended Use	7	3. Electrical Parameters	30
6. Before the First Ride	8	4. Dimensions & Material	30
7. Before Every Ride	13	5. Features	31
8. Safe Riding	16	6. TFT screen instructions	33
Tips for Riding a Pedelec	21	7. Functional description	37
Service	23	8. Parameter setting	52
Torque Settings	27	9. Error Code define	53
		10. Assembly instructions	54
		11. Connector descriptions	55
		12. Assist level instructions	55

1. Introduction

Thank you for choosing an Ignite e-Bike. This manual has been designed to help get a better understanding of your Commuter eBike designed in Australia and compliant to Australian standards (EN15194).

EN

Safety instructions.

Please familiarize yourself with this manual.

Preparations before riding:

Wear your helmet, and other protective gears before riding to protect yourself from damage in case of an accident.

Max load:

The maximum weight including the rider, all luggage, and child/child seat if fitted is 120kg.

Notes



- Your Commuter eBike is fine to be ridden in the rain, after all we are in Australia. Please ensure however that if going through puddles or other bodies of water that the depth stays below the battery and other electronics to ensure they remain protected from submersion.
- Please use the dedicated charger which has been specifically designed for this bike.
- Please ensure adequate ventilation when charging.
- Please don't modify the luggage carrier as it's been engineered to suit the Commuter bike.
- It's a good idea to utilise the rear brake predominately, particularly when going down-hill so that the centre of gravity doesn't fall too far ahead of the bike.
- When cleaning the bike, please avoid water being directed onto the electric components. It's recommended to turn the bike off before cleaning.

2. General Information

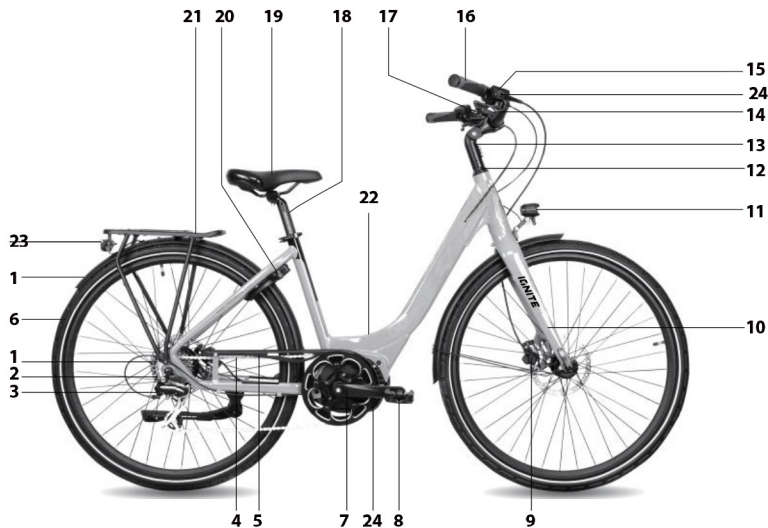

- | | |
|--------------------|------------------------|
| 1. Wheel | 13. Handlepost |
| 2. Cassette | 14. Handlebar |
| 3. Rear Derailleur | 15. Shifter |
| 4. Chain | 16. Grip |
| 5. Chain Protector | 17. Controller/Display |
| 6. Motor | 18. Seat Post |
| 7. Crank set | 19. Saddle |
| 8. Pedal | 20. Integrated Lock |
| 9. Brakes | 21. Carrier/Rack |
| 10. Fork | 22. Frame |
| 11. Light/Front | 23. Rear Light |
| 12. Headset | |

EN

Meaning of Icons



Indicates how to use the product or items that require special attention.



Incorrect action could result in damage to the equipment.



Life-threatening danger if instructions are not followed or preventive measures are not taken.



You must have the proper tool, such as a torque wrench for items that require a specific torque. A torque that is too high or too low can cause parts to fall off or break and can lead to serious accidents and injuries.

3. Legal Details

Declaration of Conformity

This user manual complies with the requirements of EN 15194 and Machinery Directive EC/2006/42. See the separate Declaration of Conformity insert.

Edition 2 Rev 2, October 2018

EN

4. Local Regulations

Pedelec stands for pedal electrical cycles. They are also known as EPACs which stands for Electrically Power Assisted Cycles. Pedelecs are bicycles with a motor that provides assistance when a rider starts to pedal. The A-weighted emission sound pressure level at the driver's ears is less than 70 dB(A). When a rider stops pedaling, the assistance stops. Some bikes will also have a push assistance mode with a max speed of 6 km/hr.

In general, electric bikes are viewed by law as more similar to a conventional bicycle than a motorized scooter or motorcycle. In most cases, an electric bike can be ridden in bike lanes, on bike paths, and can be locked to bike racks like a regular bicycle. Riders are not required to have a driver's license to operate an electric bike and are not required to obtain any special licensing or registration for their pedelecs.



It's important to note that the specific laws, rules, and guidelines governing electric bike use may vary from country to country. It's important to familiarize yourself with the laws in your specific location before you begin riding your pedelec. Take time to learn local bike laws before hitting the road.

5. Intended Use

Built for Commuters, not Stuntmen



- This bicycle is only designed for one person riding with both wheels in contact with the ground. They are not intended for racing, jumps, hops, wheelies or anything of the kind. The manufacturer and dealer are not liable for any direct or consequential damages. The warranty will be void if your pedelec is not used in accordance with the intended usage.



- Using the bike for off-road riding, jumps or stunts may cause damage to the frame and risk injury or death to the rider.

Watch the Weight



- Maximum carrying capacity =Rider weight +Cargo weight
- If carrying cargo or extra weight, make sure the bike is stable and is within the maximum load capacity.
Practice handling the bike in a safe area before riding on public roads.

CE	EPAC according to EN 15194
	Max . 250W,25km/h
	Bike/Max weight: 22.8 kg/120 kg
	Model: CC01
	Model Year: 2023

CE Frame Sticker example



- If not properly handled, sudden shifts in load while riding can affect your balance and lead to serious injury or death.

6. Before the First Ride

Hit the Books before You Ride

Spend some time to understand how to operate and use your new bike before hitting the road by reading through this manual thoroughly.

Please Check

Electrical system

Make sure you are familiar with the function of all the controller buttons and meaning of the displays.

Please consult the information in the relevant section from the manual.

Wheels

Check the tire pressure and make sure it is within the minimum and maximum values indicated on the sidewalls of the tires.

Spin both Wheels to make sure they rotate smoothly, are true (not wobbling) and do not rub against the Brakes. If the Wheel wobbles side to side or rubs against the Brake Pads, take the bike to a qualified bike shop to have the Wheel trued or replaced.

Wheels that do not run true may indicate problems with the Spokes or Tires.

Headset

Stand with the Front Wheel pressed firmly between your legs and try to twist the Handlebar. If movement occurs, realign your Handlebar and tighten the Headset and handpost base.

Lift the Front Wheel off the ground and swing it from side to side. Does it feel smooth? If you feel any binding or roughness in the steering, you may have an overly tight Headset.



Brakes

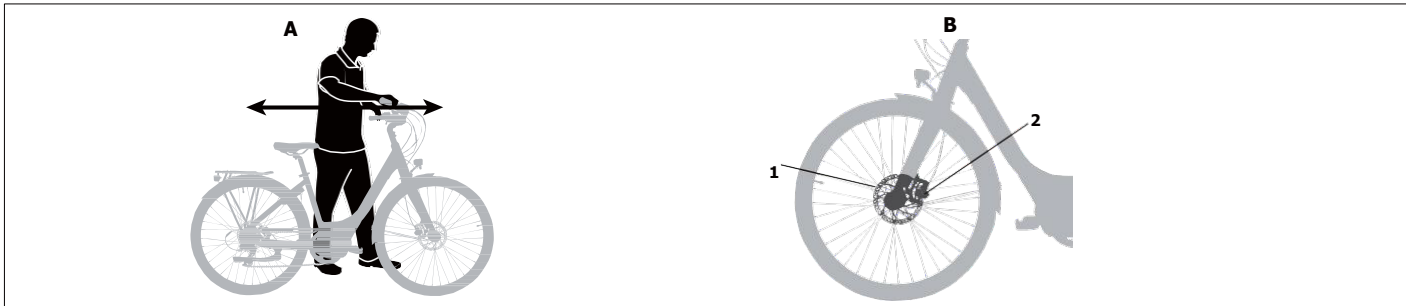

- Test your Brakes by standing next to your bike, pull both Brakes, and rock the Bike back and forth. (A) The Bike should not roll and the Brake Pads should remain firmly in place.
- Does your bike feel solid? If you feel a clunk with each forward or backward movement of the bike, you probably have a loose Headset so please tighten it. Note that for certain Disc Brakes you may feel a bit of play when attempting to rock the bike back and forth. These are caused by the built-in clearances between the Brake Pads and the Brake Caliper to allow for thermal expansion and is considered normal. In these cases, it's not a loose Headset.
- Disc Brakes (B) have a Disc Rotor (1) and a Disc Caliper (2). Pads inside the Disc Caliper squeeze the Disc Rotor to slow the Wheel but can get very hot under use. Do not touch them immediately after riding.
- In Australia, the left lever operates the rear brake and the right lever operates the front brake.



Be careful not to damage the Disc Rotor or Disc Caliper when changing wheels or by pulling the Brake Levers when the Disc Rotor is not aligned.



Make sure to test the braking power before heading into traffic. It can be much more powerful than what you are used to. Squeezing the Lever too fast can lead to unintended sudden stopping and cause you to crash or get rear ended.

Gears

Test ride in a safe area away from traffic to familiarize yourself with the function of the Gear Shifters and how to upshift and downshift. Check that indexing (shifting from gear to gear) is crisp and that you are able to shift into the lowest and highest gears without the Chain skipping.

Check for tight links in the Chain and that the Chain turns freely through the Gears.

EN With a pedelec, drive assistance begins immediately when you step on the pedal. Squeeze the brakes before mounting your bike to avoid any unintentional movement.

For any noise



Lift the bike up about 10 cm and drop it to the ground. If you hear any unusual noise or notice issues with Frame stability (especially Frame and Handlepost Joints), book it for a service with your local bike shop.

How the bike fits

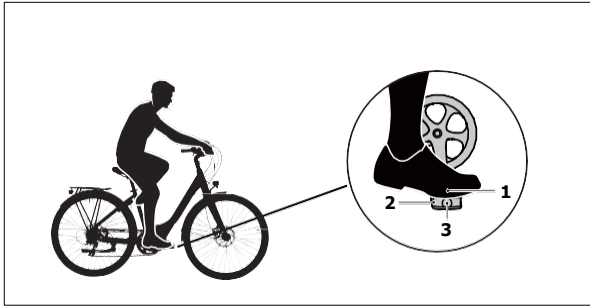

The best riding position is the one that you are most comfortable in, but a badly adjusted bicycle may lead to back or joint pain and reduce your control. Check that your Saddle and Handlebar are at the correct height and that you can reach Brake and Gear Levers comfortably.

For most people, the ball of the foot (1) should be placed on the Pedal (2) directly above the Pedal Spindle (3).

Saddle

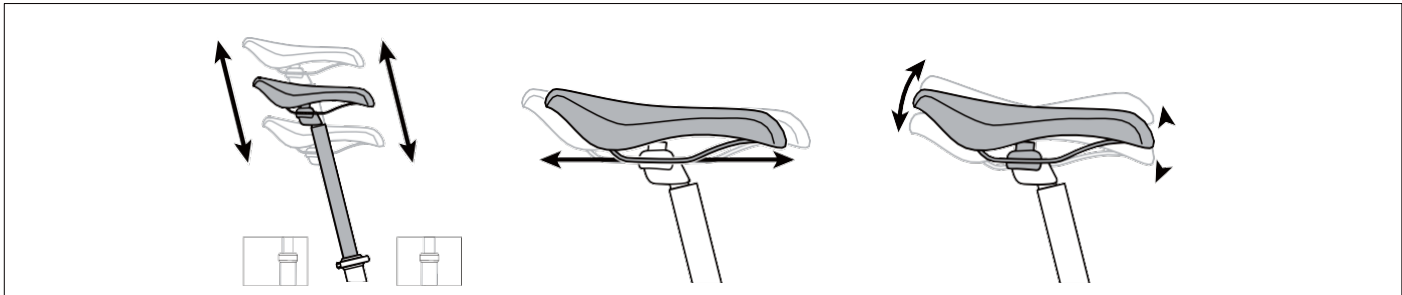

The saddle height is an important component of the overall riding position. While seated, you should have a slight bend in your knee when the Pedal is pushed down all the way. The leg should not be fully extended so make sure the Saddle is not too high. If the seat is too low, repetitive strain on the knee may lead to pain.

The Saddle can be moved up and down, forward and back and angled up and down. Play around with it to get the best fit. A badly fitted Saddle can injure nerves, joints, and blood vessels.

Refer to for appropriate saddle rail torque values

- When riding, your hips should remain stationary and your knee should only bend about 20-25° when the pedal is all the way down.
- The Saddle should be roughly parallel to the ground, but if it's not comfortable, tip the Nose down to relieve pressure on the crotch or up to distribute your weight over a greater area of the Saddle. The seat should be tilted no more than 5° up or down.
- Moving the Saddle backward works your glutes harder and forward works your quads harder. Generally, the front of the knee should not pass the Pedal Spindle. Once comfortable, check your saddle height again and adjust as necessary.



Do not raise the Seatpost above the minimum insertion line etched on the post. Doing so may result in post/frame failure and serious injury. If proper saddle height cannot be achieved without raising the post above this line, you need a longer Seatpost. Similarly, do not lower the Seatpost below the maximum insert mark when riding. The lower exposed portion may hit objects on the pavement and cause a riding hazard.

EN

Stem

Models fitted with Stems are adjustable in angle and height without tools. Please refer to the included manual for information on how to adjust the Stem positions.

Handlebar orientation

Rotate your Handlebar so that your palms are supported and that your fingers can easily reach the Brake and Gear Levers. For Handlebar adjustment procedures, refer to the corresponding information in the manual.

7. Before Every Ride

Be sure to check the following before every ride:

Electrical System

- Check that the battery is seated properly in the carrier on the frame and fully plugged in.
- Check the controller display for any warnings or error messages. Resolve the error before riding.
- Check that the battery is adequately charged for the length of ride you are planning to do.
- Make sure the front and rear lights are illuminated when they are actuated and remain on when the bike is at a standstill.

Mechanical

As with all mechanical components, the bicycle is subjected to wear and high stresses. Different materials and components might react to wear or stress fatigue in different ways. If the design life of a component has been exceeded, it may suddenly fail, possibly causing injuries to the rider. Any form of crack, scratches, or change of coloring in highly stressed areas indicate that the life of the component has been reached and it should be replaced.

ABC Quick Drop Test

We design our bikes so that they can be everyday companions. For safety, however, we recommend this test before each ride:

A

AIR

Check the air pressure on your Tires. Use your thumb to press the Tires. They should feel nice and firm but avoid over-inflating.



B

BRAKES AND BARS

Check the Brakes by squeezing the Levers and making sure the bike stops. Check that the Brake Cables are undamaged and untangled.

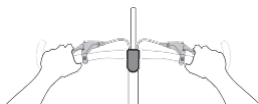

Check that Bars (Handlebar, Handlepost, Handlebar Extensions) are tightly in place and undamaged by turning the Handlebar left and right with the Front Wheel in between your legs.



C

CHAIN AND CABLES

Check that Chain turns freely through Gears by rotating the Crank backwards, and make sure Cables are undamaged.

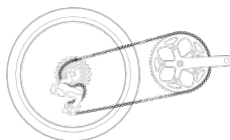

QUICK

QUICK RELEASES

Check that Quick Releases (Wheels, Seat Tube, Handlepost) and Joints (Frame, Handlepost) are closed securely.



DROP

DROP THE BIKE

Lift the bicycle a few inches and drop it to the ground. If anything shakes or rattles, make adjustments before riding.



Rim

The Rim should be clean and undamaged. Look out for discolorations, scratches or wear. If you have Rim Brakes, the contact surface should be checked for pits or grooves. Some Rims have a wear indicator on the brake contact surface; once the Rim wears down to the wear indicator it should be replaced.



A worn or damaged Rim may fail without warning and cause the rider to crash.

Wheels

- Check that the Wheels are fixed inside the Fork by pushing from each side. They shouldn't slide along the Hub Axle.
- Use your hands to squeeze the neighboring pair of Spokes. If Spoke tension difference is pronounced, have your Wheel trued.
- Make sure your Wheels are securely seated by lifting each end of the bike and knocking the Wheel toward the opening of the Dropout; the Hub Axle should stay in position.

Saddle

Try to turn the Saddle by hand to make sure the Seatpost and Saddle are securely clamped; there should be no movement in either the Seatpost or Saddle.

8. Safe Riding

Keep Your Eyes on the Road

Check for potholes and other dangers, like car doors opening and kids playing. Also, think about your own visibility and avoid entering vehicle blind spots.

Stay Alert

You need to stay alert when riding. Don't wear earphones or headphones that affect your hearing or sunglasses if they hinder your vision. Don't ride if you have consumed alcohol or are on medication that affects your motor skills.

Stand Out

Riding in low light or poor visibility, such as at night, dawn, dusk, in rain or in fog is much more dangerous than in daytime lighting conditions. Wear bright colors and reflective gear.

Stay Clean

Reflectors should be clean, unbroken and mounted correctly. Don't cover reflectors with loose clothing or bags. Also, they only reflect light in some directions, so you need lights to make sure you are seen with all around visibility. Make sure your lights are working properly.

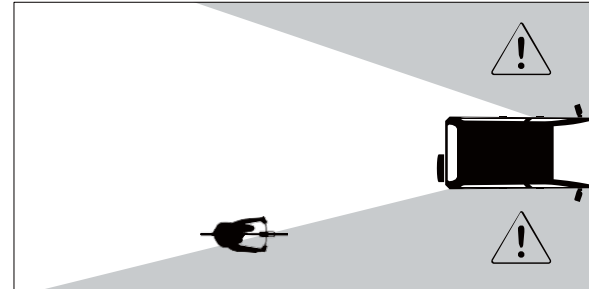

Using Brakes

Go with the flow

Braking distances increase in wet weather or under heavy load, so brake more gently and earlier under those circumstances.

Gradual Braking

To prevent skidding when slowing or stopping your bike, pull Brakes gradually. Skidding does not slow you down faster and means you can't steer well so it should be avoided.

Lean back

If you slam on your Front Brake, you may fly over the Handlebar or your Rear Wheel may slide out behind you. If the Rear Wheel rises, lean back and ease off your Front Brake.

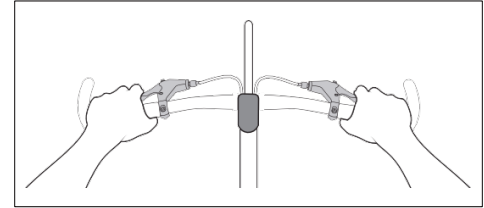

EN

- Use a bell, horn or your voice to indicate your intention to pass and do so in advance so as not to startle the rider you are passing.
- Travel in a straight line unless you are avoiding hazards or passing and always indicate your intention to turn or pass.

Charging

Your Commuter comes with battery charger specific to your bike. Specific charging methods refer to:

Off-Bike Charging

- Insert the charging plug of recharger into the battery charge hole; pay attention to the plug direction, please do not insert or dismantle by force.
- Insert the power plug of recharger into a standard power point.

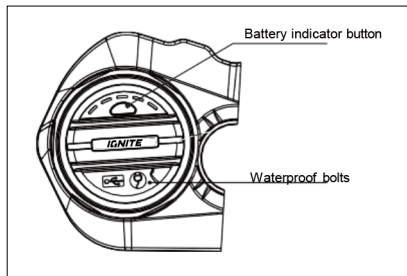

- Please check the recharger indicator. When the indicator on the recharger is red, it indicates the battery is charging, when the indicator is green, it indicates charging completed.

On-Bike Charging

Charging without removing the battery from the bike: Turn off the power to the monitor and stop using the bike.

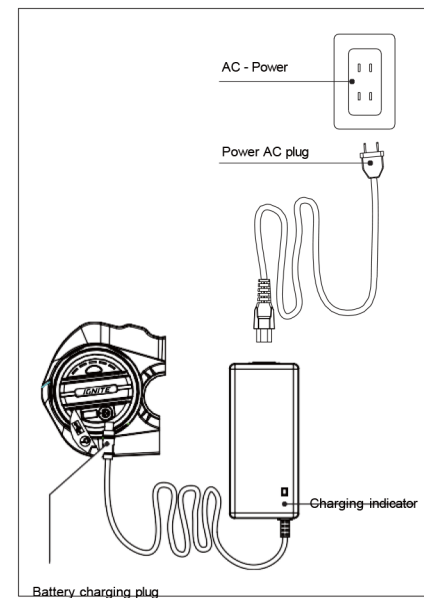
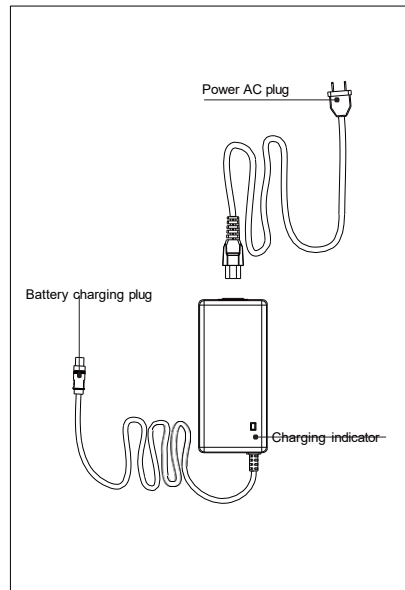

Battery

- Your Commuter is equipped with a lithium-ion battery. Modern lithium-ion batteries have more than 500 full discharge cycles before the capacity decreases. The battery does not have a memory effect so you may charge the battery at any time and do not have to wait until the battery is completely depleted before charging again. If you're going to stop using the bike for more than a month, charge the battery to about 80% full before storage. Never fully drain the battery and leave it uncharged for a prolonged period of time as this may damage the battery permanently.
- Only use the original charger from the battery manufacturer. Do not use another charger, even if the plug fits.



Batteries must not be disposed of in landfills or by incineration

- When your Commuter's battery has reached the end of its service life, it should be treated as hazardous waste material and should not be disposed of in normal household trash.

Tampering with the motor system



It is forbidden to tamper with the motor system, in any way. Aftermarket devices or software that alters the speed limit and/or an addition of throttle and/or other devices will void the warranty of your bike. It will potentially create a severe safety hazard and might be considered unlawful.

Removing / Installing the Battery

To remove the battery, insert the key into the key hole and turn counterclockwise. Keep the hand on the battery and push it back into the cavity with a solid push until it clicks into place.

EN

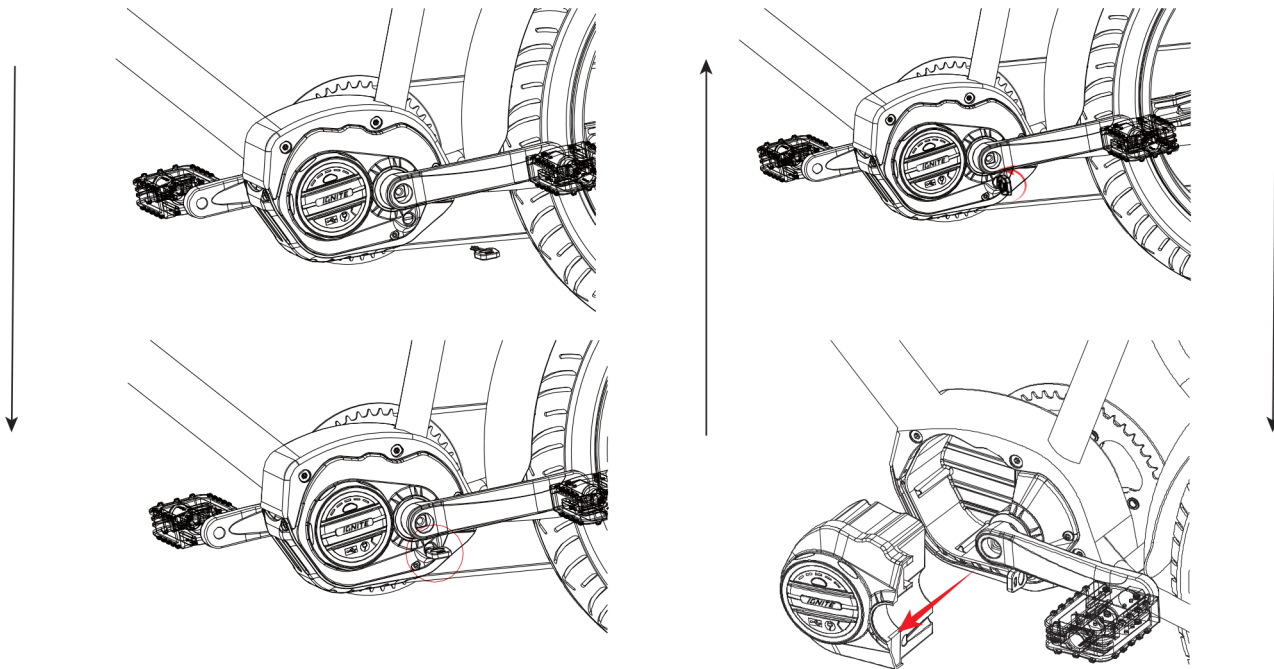

10. Tips for Riding a Pedelec

Starting Off

When the controller is on, the power assist will be applied immediately when you step on the Pedal. It is, therefore, recommended to mount your Commuter with the controller off. After you are seated, make sure no weight is on the pedals to prevent accidental movement, then turn on the controller. Start off at the lowest level of assistance.

Selecting the Correct Level of Assistance

Do not only ride in high gear with power assist. Change gears as you would on a conventional bicycle to maintain an efficient cadence for your riding style. This will maximize the efficiency of the assistance to your power input.

Riding with Power Assistance

How much you pedal determines how much assistance the motor provides. All pedelecs have an internal control algorithm to stop assisting as soon as you stop pedaling. This is an inbuilt safety feature conforming to EN 15194 (EPAC – Electrically Power Assisted Cycles).

When cornering on a pedelec, stop pedaling sooner than you are used to, otherwise, you may have too much speed through the turn.

As you are likely to be traveling at an average above speed, look further up the road and be ready to brake whenever a possible situation appears before you.

Due to the near silent nature of an electric motor, pedestrians and other cyclists may not hear you approaching.

Ride defensively, wear bright clothing, signal your intentions, and use your bell when necessary.

Riding without Power Assistance

Your Commuter is designed to be ridden normally like a conventional bike if the power assist is turned off. If you are going downhill or want to extend your range you can turn off the assistance but keep the display on to watch your speed. However, if the battery runs empty during your ride, the lights will not function since they are connected to the motor battery.

Range of Battery

Range varies depending on factors such as:

Average riding speed

The faster you go the more energy is required and the quicker the battery will be depleted. However, if you ride faster than the maximum assist speed, the motor assist will completely shut off and the motor will not drain the battery.

Assistance level used

The best way to conserve battery power is pedaling effort! Using less assistance and exerting more effort into pedaling will decrease battery power consumption and result in a longer range.

General maintenance

Keep Tire pressure correctly inflated. Maintain and lubricate moving parts.

Stop-and-go traffic

Starting from a standstill will always require more energy. To extend your range, start in Eco mode.

Rider's weight and cadence

The motor will use up more energy for heavier riders. Keeping a cadence of at least 60 rpm will be more efficient.

Road conditions (road surface, terrain, wind)

Unpaved (dirt, gravel) roads, headwinds, and going uphill will reduce your range.

11. Service



Your Commuter has many advanced parts and components. Many bicycle service and repair tasks require special knowledge and tools. Do not begin any adjustments or service on your bicycle unless you are able to properly complete them. Improper adjustment or service may result in damage to the bicycle or cause serious injury.

Spare Parts

When replacing components such as the Frame, Fork, Tires, Rims, Brakes, Front and Rear Lights, Kickstand, Handlebar, Handlepost, Stem, Drive Unit, Battery, or Control Unit/Display, etc., use the original spare parts. They are tested to ensure they work safely with your pedelec. We recommend you visit a bike shop for parts and repairs.



Service actions that you can (and should) perform do not require special tools or knowledge beyond what is presented in this manual. They are listed below:

Air

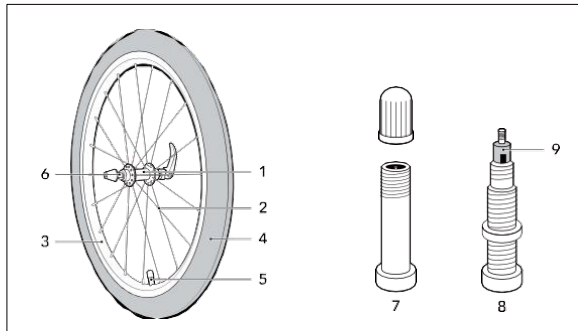

- The Wheel consists of a Hub (1), Spokes (2), Rim (3), Tire (4), Valve (5) and Axle (6).
- The Valve may be a Schrader (7) or a Presta (8) type. Presta Valves have a Valve Cap (9) that must be loosened before inflating.
- Check the air pressure is within bounds as indicated on the sidewall of the Tire.
- Check your Tires to see if they have adequate tread depth and no punctures.

Brakes

Make sure the Brakes are working with proper stopping power. The Levers should stop short of touching the Handlebar.

Riding with improperly adjusted or worn Brakes is dangerous and can result in injury or death. Check the Brake manufacturer's instructions for care and operation of your Brakes. Keep Brake surfaces clean and free from oil or lubricants. Replace worn Brakes with authorized replacements.

Chain, Cranks, and Cables



A bicycle drivetrain . The drivetrain consists of the Cranks (1), Chainring (2), Rear Sprocket (4) , Chain (5), Rear Derailleur (3). Bicycle gears are numbered from 1 upwards, with 1 being the lowest and easiest gear.

The lower gears are used for climbing and the higher ones are for descending. We recommend you practice shifting gears in a safe location.

To check that your Chain is fully connected with the Chainring, rotate the Cranks and ensure no gaps or kinks are visible.

Before riding, shift through all Gears and make sure the Chain and Derailleurs are fully functional. If your Gears are not shifting smoothly, we recommend consulting your dealer. If the Rear Derailleur is malfunctioning, do not use the highest and lowest gears of the Rear Cassette since the Chain or Wheel may get jammed which can cause bicycle damage or rider injury.

Check all control Cables and Housings for rust, kinks, and fraying. They should be replaced if damaged.

Chain Tension

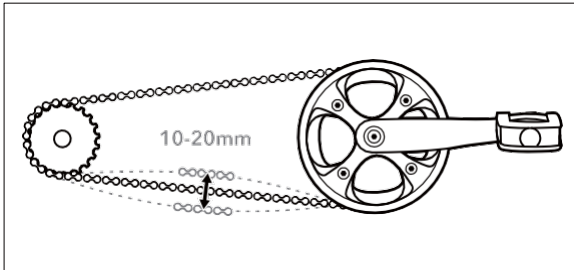

The chain endures huge tension forces from pedaling. For optimal shifting and efficiency, the Chain must connect with the teeth properly.

To check for excessive slack, shift to the smallest gear on the Cassette (if applicable) to create the greatest amount of slack in the Chain. Chain slack should be within 10-20 mm per span. This amount of slack is equally applicable to all internal hub gear chain drives.

Excessive slack can be caused by a Chain that is worn and stretched. A stretched Chain will not sit properly in the teeth. Over time, gaps between the teeth of the Sprockets becomes greater, mirroring the shape of the Chain. Replacing a Chain when it is worn will help extend the life of the most expensive Cassette and Chainring.

If you are not sure if the chain slack is from chain wear or wheel misadjustment, take your bike to the dealer for servicing.



Do not clean your Commuter using a pressurized spray or steam because water can be forced into sealed areas and damage your bike.

Quick Releases

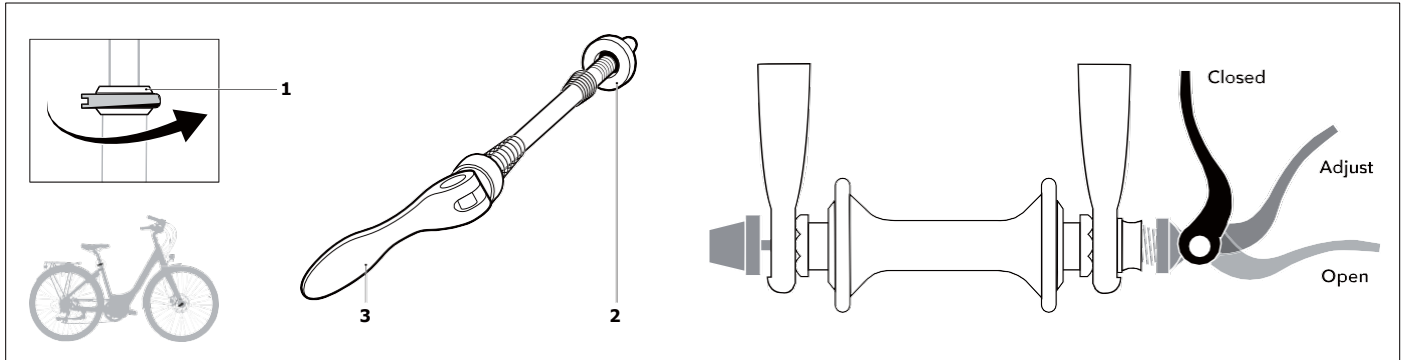

The Quick Release uses over-center cam action to clamp the component in place and allows for easy, tool-less removal.

A Quick Release has a Clamp (1), an Acorn (2) and a Lever (3). The concave side closes inward.

The Acorn allows you to adjust the clamping force. Closing the Lever as it passes the over-center point requires increasing force. This force should require you to use the palm of your hand.

Quick Releases hold the Wheels, Seatpost, and Handlebar in place.

When tightened on Wheels, the Quick Release should emboss the Fork Dropouts.

When tightened on the Seatpost, the Seatpost should not rotate.

When tightened on the Handlebar, the Handlebar should not rotate.

When the Lever is closed, position it in a way so that it cannot accidentally open through contact during riding.



Quick Releases are very convenient but many accidents occur because of misuse. Improper adjustment may result in damage to the bicycle or in an accident which can cause serious injury or death.

Quick Release and Fasteners



Check that quick releases and important nuts and bolts that keep your wheels, handlebar and seatpost in place are properly closed and adequately tightened. Correct tightening force is vital. Too little force and the fastener may not hold securely. Too much force and the fastener can strip threads, stretch, deform or break. Either way, incorrect tightening can result in component failure and cause loss of control and accidents. See section 15 for correct torque values. If you're unsure, visit your dealer and ask them to show you the proper way.



All other repair or maintenance which is not specifically described in this manual should be performed by your dealer.

12. Torque Settings

EN

It's all Torque to Me



Torque Values are standard measures of how much you must tighten a bolt and are listed below. When a torque value is given, a torque wrench should be used to ensure that the correct torque is applied.

Recommended Tightening Values - Torque Values

Frame and Fork			
Component	lbf.in	Newton Meters (Nm)	kgf.cm
Kickstand Mounting Bolt	53-60	6-8	61-69
Water Cage Mounting Bolt	25-35	2.8-4	29-40
Rack Bolts	25-35	2.8-4	29-40
Fender Bolts	50-60	5.6-6.8	58-69

Brakes			
Component	lbf.in	Newton Meters (Nm)	kgf.cm
Brake Lever (Flat Bar)	53-60	6-6.8	61-69
Brake Lever (Drop Bar)	55-80	6.2-9	63-92
Disc Rotor to Hub (M5 bolts)	18-35	2-4	21-40
Caliper Mount	55-70	6.2-7.9	63-81

Wheels			
Component	lbf.in	Newton Meters (Nm)	kgf.cm
Free Hub Body	305-434	34.5-49	352-499
Cassette Sprocket Lockring	260-434	29.4-49	299-499
Front Axle Nuts	180	20.3	207
Rear Axle Nuts	260-390	29.4-44.1	299-449

Drivetrain			
Component	lbf.in	Newton Meters (Nm)	kgf.cm
Pedal into Crank	307	34.7	353
Crank Bolt (Spline and Square Spindles)	300-395	33.9-44.6	345-454
Bottom Bracket (External Shell)	610-700	40-50	702-805
Bottom Bracket (Cartridge and Cup-and-Cone)	435-610	49.1-68.9	500-702

Others			
Component	lbf.in	Newton Meters (Nm)	kgf.cm
Steerer Clamp Bolt (Stem)	70-89	8-10	80-102
Top Cap Bolt	35-53	4-6	41-62
Handlebar Clamp Bolts (4 Clamp Bolts)	36-53	4-6	41-62
Saddle Rail Clamp	70-89	8-10	80-102



PRODUCT SPECIFICATION

(TFT LCD Display)

1. Product Name

- TFT LCD display
- Model : 860C

2. Suppliers

- APT(Tianjin) Develop Co., Ltd.

3. Electrical Parameters

- 3.5inch IPS screen
- 24V/36V/48V/52V battery supply
- Rated operating current : 40mA
- Max operating current : 100mA (36V battery, with USB equipment changed)
- USB changing port : 5V 500mA
- Off leakage current < 1uA
- Operating temperature : -20~70°C, Storage temperature : -30~80°C

4. Dimensions & Material

- Product shell is ABS+PC, LCD transparent window is imported super tempered glass, full bonding process.
- Dimensions : host/L96.6mm*W71.6mm*H6.1mm



5. Features

- Suitable for low temperature, Max -20°C.
- High-contrast 3.5inch IPS colorful matrix screen.
- Ergonomic external button design, easy to operate.
- **Speed display:** AVG SPEED, MAX SPEED, SPEED(Real-time).
- **Kilometer / Mile:** Can be set according to customers' habits.
- **Smart battery indicator:** Provide a reliable battery indicator.
- **Maintain reminded:** Maintenance icon to be determined.
- **9-level Assist:** 3-level/5-level/9-level optional.
- **Mileage indicator:** Odometer/Trip distance/ Clock/ Riding time/Range.
- **Power/Current indicator:** real time power indicator or Current.
- **Error code indicator.**
- **Light sensor(Optional)**
- **Software upgraded:** Software can be upgraded through UART.
- **USB charging port : 5V/500mA**

6. TFT screen instructions



7. Functional description

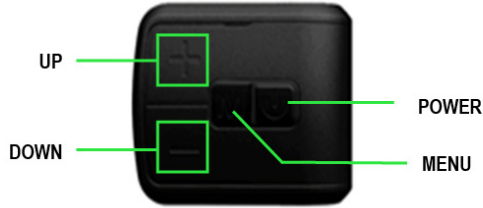

7.1 Power on/off

Press and hold **POWER** button for 1 second, the controller can turn on/off display. The controller can automatically shut down the display when there is no operate & ride for X minutes (X could be 0~9).

7.2 Assist level operating

Short press **UP/DOWN** button can change the assist level. Top assist level is 9, 0 for neutral. Level quantities can be adjusted according to the customer requirements.



7.3 Speed & Mileage mode switch

Short press **MENU** button can change the speed and mileage mode,
TRIP→ODO→RANGE→TRIP→TIME→MAX SPEED→AVG SPEED

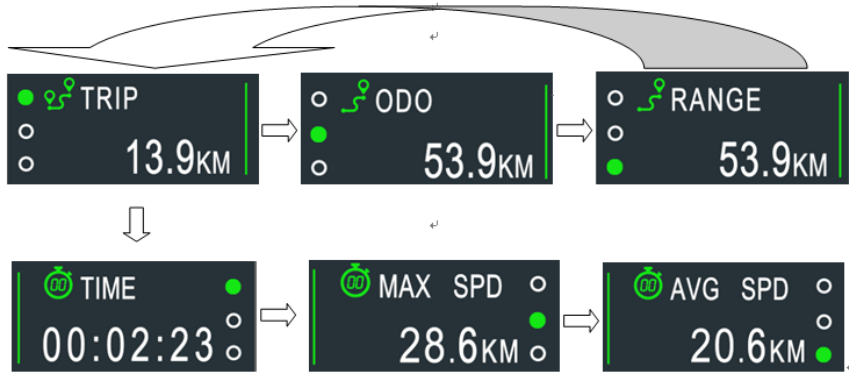

*Range need smart BMS support.

**If there is no operation for 5 seconds, display will return Speed (Real-Time) display automatically.

7.4 Headlight/backlight On/Off

Press and hold UP button for 1 second can turn on/off the headlight, and the scree will switch to the corresponding mode.

*The motor does not work when the battery voltage is low, Display still can keep the headlight on for a while when E-bike is in riding.

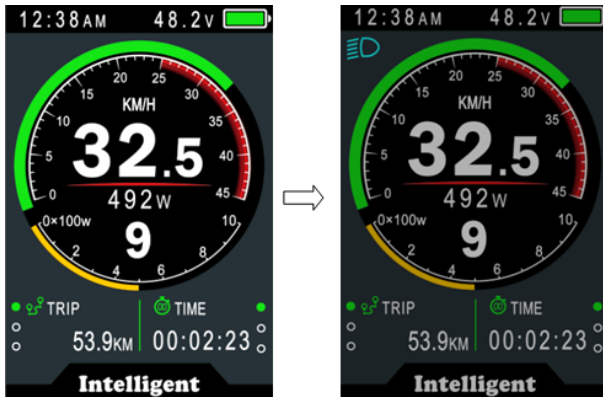



DAYTIME MODE

NIGHT MODE

EN

7.5 Walking mode (6km)

Press **DOWN** button → 0-level →  walk-level → press and hold **DOWN** button →  flash, the bike get into walking mode, out of the mode when release the button.



* This feature needs to be supported by controller.

7.6 Data cleanup

Press and hold **UP/DOWN** buttons together for 1 second can reset several temporary data, temporary data include AVG Speed / MAX Speed / Trip / Time.

* These temporary data can't be erased by power off.

8. Parameter setting

Double press **MENU** button (press interval less than 0.3 second) can get into setting menus, press **UP/DOWN** buttons to change the parameter setting, and press **MENU** button can switch to next item. Double press **MENU** button will exit from menu.

- Display will automatically quit menu when there is no operation for 30 seconds.
- For safety reasons , display can't get into **MENU** when riding.
- Display will quit **MENU** when start riding.

The order of parameters is as follow.

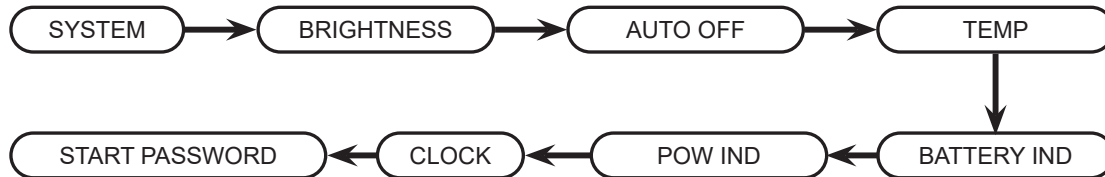

8.1 Language

Default EN, Un adjustable

MENU	
Display Setting	
➔ Language	EN
System	Metric
Brightness	
Auto off	8 min
Temp	hide
Battery Ind	Percent
Pow Ind	Current
Clock	>
Start Password	>
Basic Setting	
...	
EXIT	

8.2 System

Press **UP/DOWN** button to switch between Metric / Imperial.

MENU	
Display Setting	
Language	EN
➔ System	Metric
Brightness	
Auto off	8 min
Temp	hide
Battery Ind	Percent
Pow Ind	Current
Clock	>
Start Password	>
Basic Setting	
...	
EXIT	

↔

MENU	
Display Setting	
Language	EN
➔ System	Imperial
Brightness	
Auto off	8 min
Temp	hide
Battery Ind	Percent
Pow Ind	Current
Clock	>
Start Password	>
Basic Setting	
...	
EXIT	

EN

8.3 Brightness

Press **UP/DOWN** button to change the brightness of the backlight, I is darkness IIIII is brightness, default value is IIIII.

MENU	
Display Setting	
Language	EN
System	Imperial
➔ Brightness	I
Auto off	8 min
Temp	hide
Battery Ind	Percent
Pow Ind	Current
Clock	>
Start Password	>
Basic Setting	
...	
EXIT	

MENU	
Display Setting	
Language	EN
System	Imperial
➔ Brightness	IIIII
Auto off	8 min
Temp	hide
Battery Ind	Percent
Pow Ind	Current
Clock	>
Start Password	>
Basic Setting	
...	
EXIT	

EN

NOTE: You can set brightness independently between Daytime mode and Night mode.

8.4 Auto off

Press **UP/DOWN** button to change the auto power off time, from 1 to 9/OFF, the number represent minutes to shutdown, **OFF** means disable auto off function, default value is 5 minutes.

MENU	
Display Setting	
Language	EN
System	Imperial
Brightness	
➔ Auto off	9 min
Temp	hide
Battery Ind	Percent
Pow Ind	Current
Clock	>
Start Password	>
Basic Setting	
...	
EXIT	



MENU	
Display Setting	
Language	EN
System	Imperial
Brightness	
➔ Auto off	9 min
Temp	hide
Battery Ind	Percent
Pow Ind	Current
Clock	>
Start Password	>
Basic Setting	
...	
EXIT	



MENU	
Display Setting	
Language	EN
System	Imperial
Brightness	
➔ Auto off	9 min
Temp	hide
Battery Ind	Percent
Pow Ind	Current
Clock	>
Start Password	>
Basic Setting	
...	
EXIT	

8.5 Temp

Hide only.

MENU	
Display Setting	
Language	EN
System	Imperial
Brightness	
Auto off	OFF
➔ Temp	hide
Battery Ind	Voltage
Pow Ind	Power
Clock	>
Start Password	>
Basic Setting	
...	
EXIT	

EN

8.6 Battery Ind

Press **UP/DOWN** button to change the battery indicator, Voltage / Percentage / OFF.



EN

8.7 Pow Ind

Press **UP/DOWN** button to change the Power indicator, Power/Current.

* This data represent power output of the battery (not motor).

MENU	
Display Setting	
Language	EN
System	Imperial
Brightness	
Auto off	OFF
Temp	hide
Battery Ind	Voltage
➔ Pow Ind	Power
Clock	>
Start Password	>
Basic Setting	
...	
EXIT	



MENU	
Display Setting	
Language	EN
System	Imperial
Brightness	
Auto off	OFF
Temp	hide
Battery Ind	Voltage
➔ Pow Ind	Current
Clock	>
Start Password	>
Basic Setting	
...	
EXIT	



EN

8.8 Clock

Clock setting, press MENU button get into the clock setting menu, press **UP/DOWN** button to set Year/Month/Day/Hour/Min/Sec/Clock(show or hide).

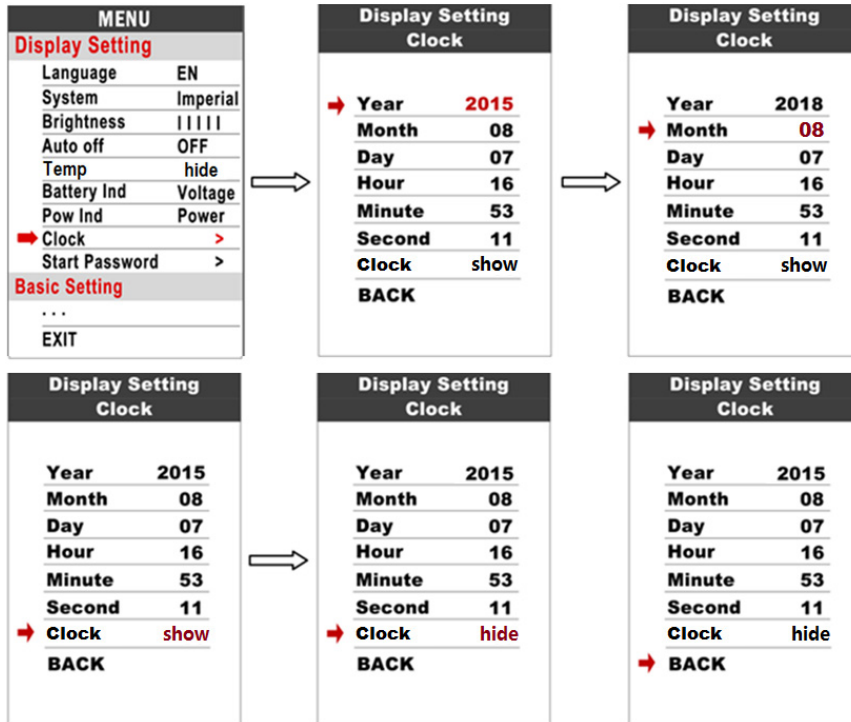

NOTE: There is a rechargeable battery inside display, it keeps the clock running when display is powered off. The battery can be charged by the external power when display is power on. This battery can maintain clock running for 100-120 days while it has not been charged. Battery may be exhausted after long time unused (after winter or transportation), you need to recharge the battery as below. Set Menu: Auto off -> OFF (make display can't power off automatically) Keep the display power on for 72 hours, it can charge the battery.

EN

8.9 Start password

Currently the controller does not support and cannot be set.

MENU	
Display Setting	
Language	EN
System	Imperial
Brightness	
Auto off	OFF
Temp	hide
Battery Ind	Voltage
Pow Ind	Power
Clock	>
➔ Start Password	>
Basic Setting	
...	
EXIT	

Basic Setting

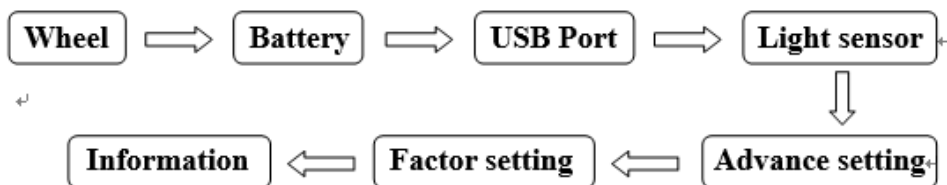

*Press DOWN button to move the red arrow to , press MENU button can show all items of the Basic Setting.

8.10 Wheel

Displays the wheel diameter value transmitted by the controller (this needs controller support).

MENU	
Display Setting	
Language	EN
System	Imperial
...	
Basic Setting	
➔ Wheel	27.5 inch
Battery	36 V
USB Port	ON
Light sensor	>
Advance setting	>
Factory setting	>
Informations	>
EXIT	

8.11 Battery

Displays the battery voltage value transmitted by the controller (this needs controller support).

MENU	
Display Setting	
Language	EN
System	Imperial
...	
Basic Setting	
Wheel	27.5 inch
➔ Battery	36 V
USB Port	ON
Light sensor	>
Advance setting	>
Factory setting	>
Informations	>
EXIT	

EN

8.12 USB Port

Press **UP/DOWN** button, select press **OFF/ON**. Will be no Voltage/Current output after switching off.

MENU	
Display Setting	
Language	EN
System	Imperial
...	
Basic Setting	
Wheel	27.5 inch
Battery	36 V
➔ USB Port	ON
Light sensor	>
Advance setting	>
Factory setting	>
Informations	>
EXIT	



MENU	
Display Setting	
Language	EN
System	Imperial
...	
Basic Setting	
Wheel	27.5 inch
Battery	36 V
➔ USB Port	OFF
Light sensor	>
Advance setting	>
Factory setting	>
Informations	>
EXIT	

EN

8.13 Light sensor

Light sensor item, press **MENU** button, enter into light sensor interface, press **UP/DOWN** button select **OFF/ON**, select Sensitivity, press **UP/Down**, select sensitivity of light sensation **HI/MID/LO**

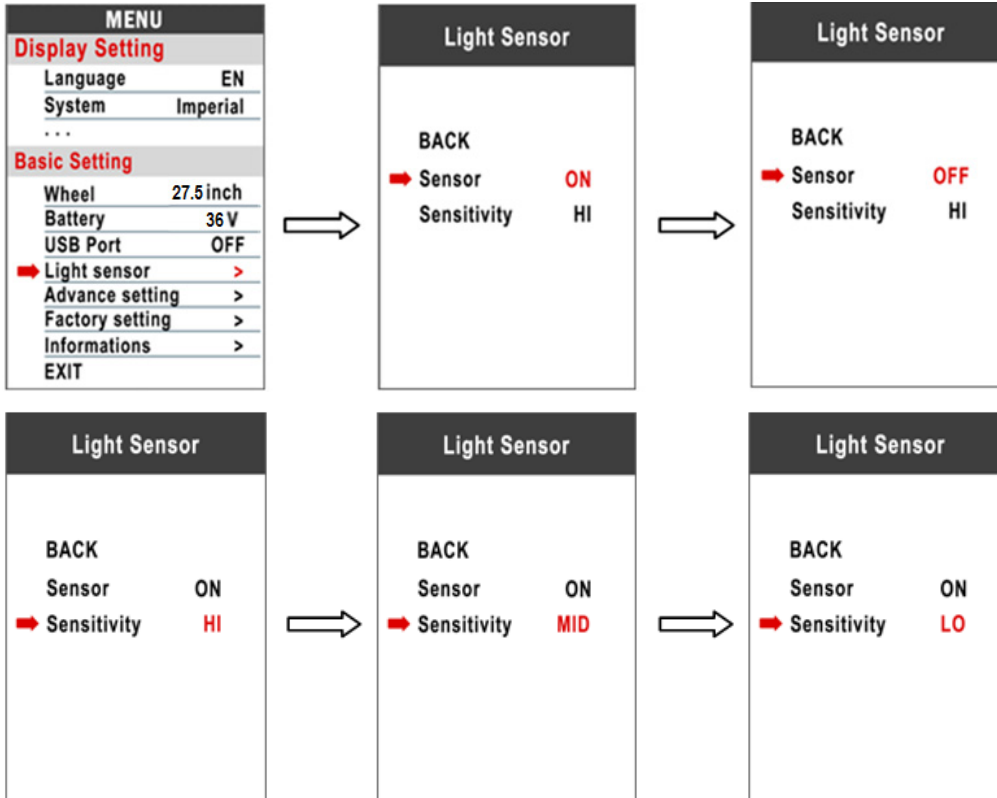

EN

8.14 Advance setting

Press **MENU** button can get into the advance setting menu, default password is '1919'.

EN

MENU	
Display Setting	
Language	EN
System	Imperial
...	
Basic Setting	
Wheel	27.5 inch
Battery	36V
USB Port	OFF
Light sensor	>
➔ Advance setting	>
Factory setting	>
Informations	>
EXIT	

MENU	
Display Setting	
System	Metric
Brightness	
Auto off	5min
Scenes	Digital
...	
Basic Setting	
Wheel	26inch
Battery	36V
Advance setting	>
Factory settings	>
Informations	>
EXIT	

Advance Setting Password
➔BACK
Input Password
0 0 0 0

Advance Setting Password
BACK
➔Input Password
0 0 0 0

Advance Setting Password
BACK
➔Input Password
1 9 1 9

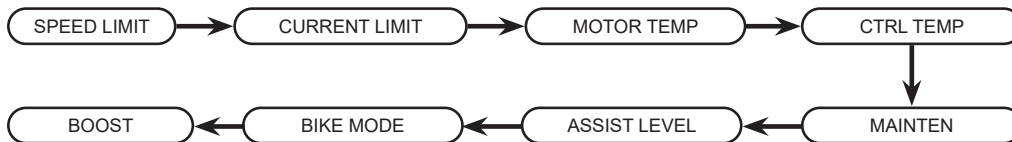

Advance Setting	
Speed limit	25Km/h
Current limit	15A
Motor Temp	28°C
Ctrl Temp	28°C
Calorie	0 Kcal
➔ Mainten	0Km
Assist levels	5
Bike mode	ECO
BOOST	N
BACK	
EXIT	

8.15 Speed limit

Display the speed limit value transmitted by the controller.

8.16 Current limit

Display the current limit value transmitted by the controller.

*Speed limit and current limit are restricted by controller and motor.

8.17 Motor Temp

Display the motor temperature value.

8.18 Ctrl Temp

Display the controller temperature value.

8.19 Calorie

Display the calorie value.

8.20 Mainten

The meter can remind maintain information, according to mileage(ODO). **Maintenance icon to be determined.**

8.21 Assist levels

This parameter can customize assist levels, options are 3/5/9.

EN

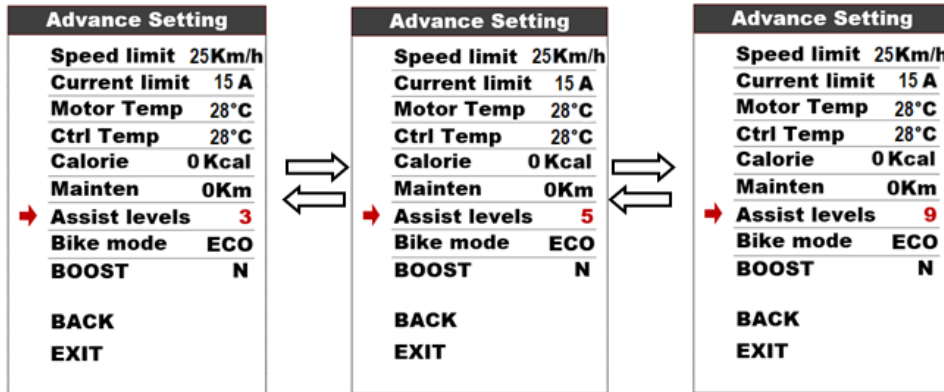

8.22 Bike mode

Press **UP/DOWN** button, select press **ECO/SPORT** mode.

Advance Setting	
Speed limit	25Km/h
Current limit	15 A
Motor Temp	28°C
Ctrl Temp	28°C
Calorie	0 Kcal
Mainten	0Km
Assist levels	5
→ Bike mode	ECO
BOOST	N
BACK	
EXIT	

↔

Advance Setting	
Speed limit	25Km/h
Current limit	15 A
Motor Temp	28°C
Ctrl Temp	28°C
Calorie	0 Kcal
Mainten	0Km
Assist levels	5
→ Bike mode	Sport
BOOST	N
BACK	
EXIT	

* This feature needs to be supported by controller.

8.23 Boost

Press **UP/DOWN** button, select press **N/Y** mode.

Advance Setting	
Speed limit	25Km/h
Current limit	15 A
Motor Temp	28°C
Ctrl Temp	28°C
Calorie	0 Kcal
Mainten	0Km
Assist levels	5
Bike mode	ECO
→ BOOST	N
BACK	
EXIT	

↔

Advance Setting	
Speed limit	25Km/h
Current limit	15 A
Motor Temp	28°C
Ctrl Temp	28°C
Calorie	0 Kcal
Mainten	0Km
Assist levels	5
Bike mode	ECO
→ BOOST	Y
BACK	
EXIT	

* This feature needs to be supported by controller.

8.24 Factory setting

Press **MENU** button enter Restore Factory settings item, set **YES** will restore all parameter to factory settings.

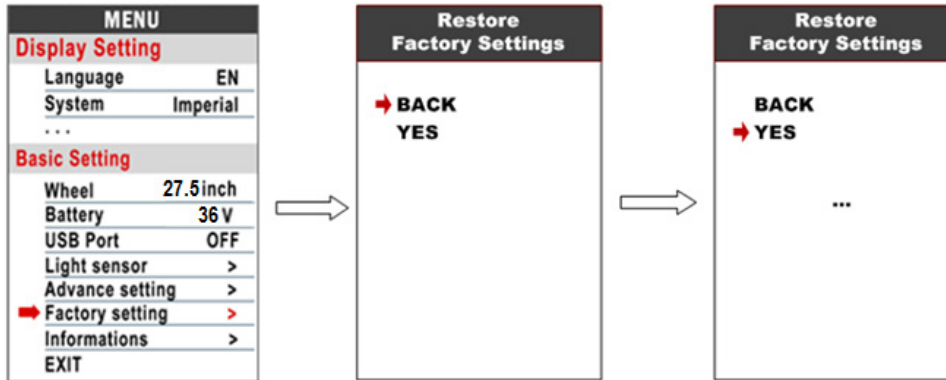

8.25 Information

Show information of the E-bike.

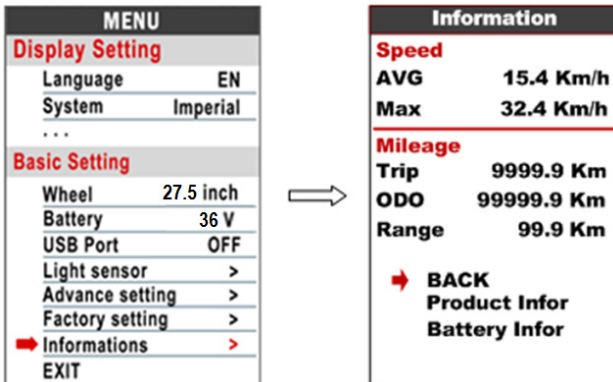

8.26 Product info

Get into this item can show hardware version software version.

Information	
Speed	
AVG	15.4 Km/h
Max	32.4 Km/h
Mileage	
Trip	9999.9 Km
ODO	99999.9 Km
Range	59.9 Km
BACK → Product Infor Battery Infor	

⇒

Product Information	
Version	
Hardware ver.	E1.0
Software ver.	1.0B-V1
Product Information	
Date	
Serial No	
→ EXIT	

8.27 Battery info

Get into this item can show all information of battery, including Voltage, Current, Capacity, Health, Cycle times, Remaining Capacity , Full Charge Capacity , Temperature, Max Uncharge Times , Last Uncharge Times , CorVolt-1.

Information	
Speed	
AVG	15.4 Km/h
Max	32.4 Km/h
Mileage	
Trip	9999.9 Km
ODO	99999.9 Km
Range	59.9 Km
BACK → Product Infor Battery Infor	

⇒

Battery Information	
Voltage	42.0V
Current	-1536mA
Capacity	90%
Health	90%
Cycle times	278
Remaining Capacity	8192mAh
Full Charge Capacity	8192mAh
→ NEXT PAGE EXIT	

⇒

Battery Information	
Temperature	25.5 °C
Max Uncharge Times	257 h
Last Uncharge Times	257 h
CorVolt-1	4097 mV
→ EXIT	

*These information needs to be supported by battery communication.

9. Error Code define

860C can show warning message,  icon shows on the screen, and show error code at the bottom of the screen, error code from 04~n, definition see the table below.

Error Code	Error description	Error display
04	Throttle error	Display 04 on LOGO position
05	Throttle on high position	Display 05 on LOGO position
07	High voltage protection	Display 07 on LOGO position
08	Motor's hall sensor error	Display 08 on LOGO position
09	Phase line of motor error	Display 09 on LOGO position
10	Motor over temperature	Display 10 on LOGO position
11	Motor's temperature sensor error	Display 11 on LOGO position
12	Current sensor error	Display 12 on LOGO position
14	Controller over temperature	Display 14 on LOGO position
15	Controller's temperature sensor error	Display 15 on LOGO position
21	Speed sensor error	Display 21 on LOGO position
23	Head light error	Display 23 on LOGO position
25	Torque sensor error-Torque	Display 25 on LOGO position
26	Torque sensor error-speed	Display 26 on LOGO position
30	Communication error	Display 30 on LOGO position
31	Low voltage protection	Display 31 on LOGO position
32	Overvoltage protection	Display 32 on LOGO position
33	Brake detection circuit error	Display 33 on LOGO position
35	15V power supply detection error	Display 35 on LOGO position
36	Button detection circuit error	Display 36 on LOGO position
37	Watchdog error	Display 37 on LOGO position



10. Assembly instructions

Please pay attention to the screw's torque value, damaged caused by excessive torque is not within the scope of the warranty.

EN

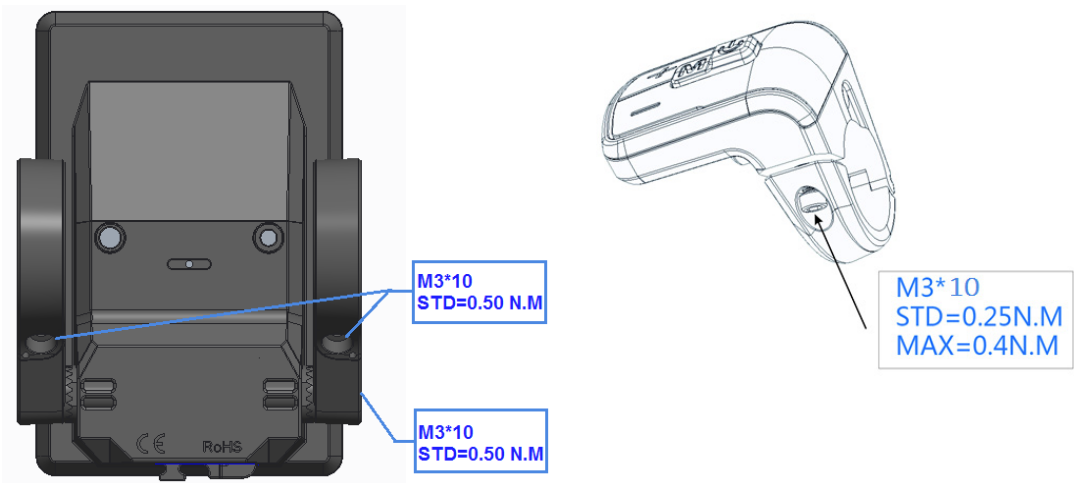

Clamps suit for 3 size of handlebar, 31.8mm, 25.4mm, 22.2mm, there are transfer rings for 25.4mm and 22.2mm, transfer ring must be assembled with the special directions.

11. Connector descriptions

Please pay attention to the screw's torque value, damaged caused by excessive torque is not within the scope of the warranty.

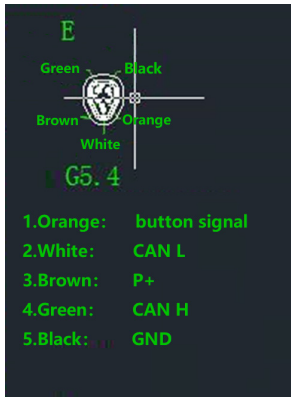

12. Assist level instructions

Assist level can be customized, the highest level is 9, and common used assist levels see the table below:

3 level	5 level	9 level	No power assist
0	0	0	
		1	
	1	2	
1		3	
	2	4	
2		5	
	3	6	
		7	
	4	8	
3	5	9	

EN

13. Certification

CE / IP65 (water proof) / ROHS.