

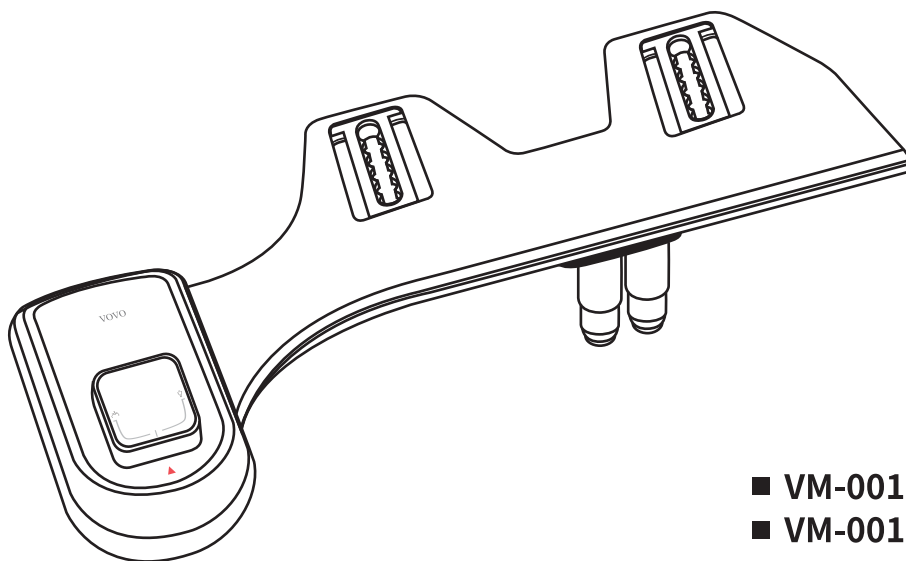

✘ Please register your product at vovo-eu.com/pages/product-registration ★ to receive full warranty benefit.★



- VM-001D
- VM-001S

- ✘ Thank you for purchasing our manual bidet.
- ✘ The manual includes a warranty card, so please keep it carefully.
- ✘ Please read the manual carefully and use it correctly.



Installation and
Function Guide

Safety Precautions

Be sure to follow these safety precautions for your safety.
This caution is to prevent any physical or material harm so please follow the safety precautions.



Caution

Violation of the indications may result in minor injury or damage.
Always be careful.



Prohibition



After using any function, please return the bidet control to the stop position.

– Unnecessary water flows until the next use.



Never disassemble, repair, or modify the product yourself.

– It may cause malfunction.



Do not place near flammable items such as cigarettes.

– It may cause malfunction or injury.



Do not spread or block the nozzle hole or between the product with your fingers.

– It may cause malfunction or injury.



Never step on the product, subject it to impact, or place heavy objects on it.

– You may fall and be injured.

– It may damage the product or cause malfunction.



When cleaning, do not use bleach, benzene, thinner, or a scrubber, and wipe with a soft cloth moistened with diluted dishwashing detergent (neutral).

– It may cause product damage.



Please install the product by connecting to the water supply tightly.

– If it is not tightened, it may cause water leakage.

– In the event of a leak, shut off the water supply to stop water supply.

(Turn the lever to clockwise to lock it.)



Must comply



Close supervision is necessary when this appliance is used by or near infants, elders, or handicapped persons.

– Children should not be permitted to use or touch this appliance without adult supervision.

Name of the Components

1. NAMES AND FUNCTIONS OF PARTS

VM-001D / VM-001S

1. Bidet controller
2. STOP
3. Feminine water pressure control (Adopted in VM-001D)
Posterior self- nozzle cleaning (Adopted in VM-001S)
4. Posterior water pressure control
Posterior self-nozzle cleaning (Auto)
5. Rigging screw
6. Detachable dual nozzle

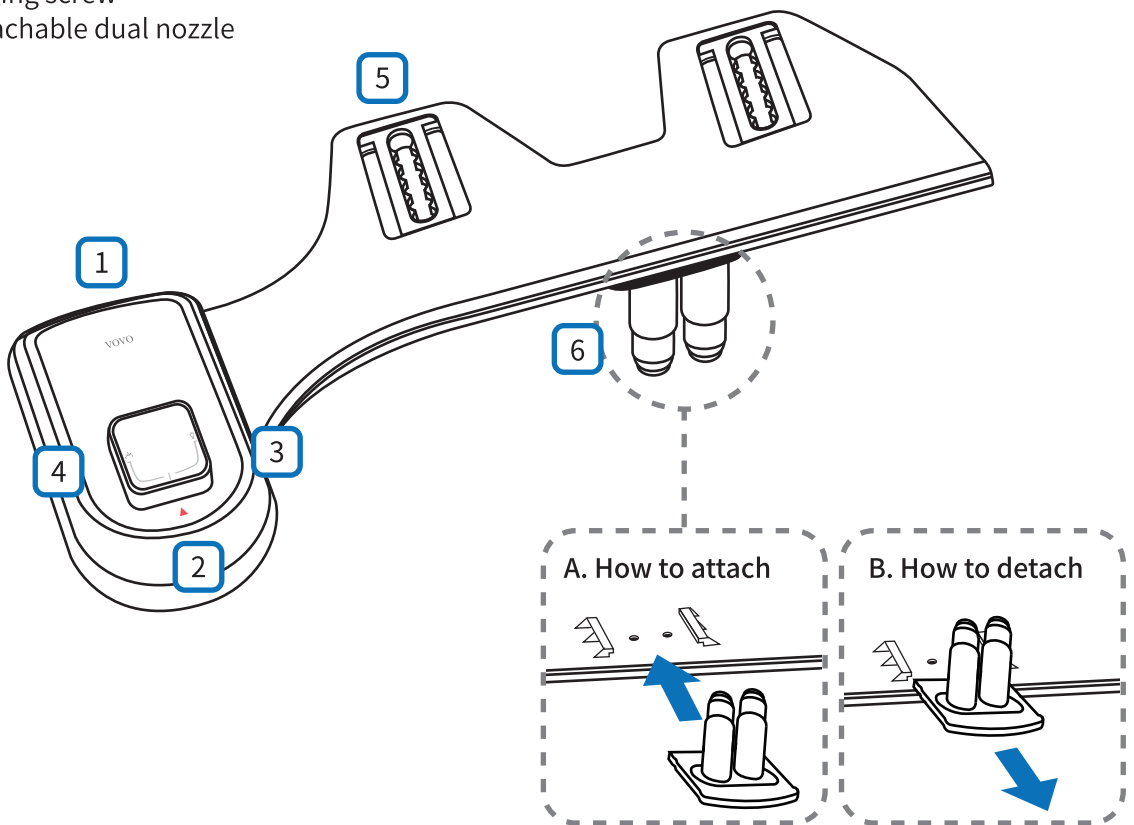

Parts

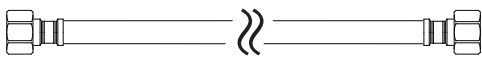

Metal Hose
(23.6")

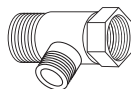

T-Connector
(7/8"x7/8"x1/2")

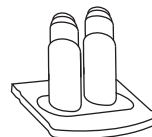

Dual Nozzle
(VM-001D)

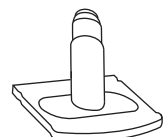

Single Nozzle
(VM-001S)

Installation Method

2. Install the body on the toilet

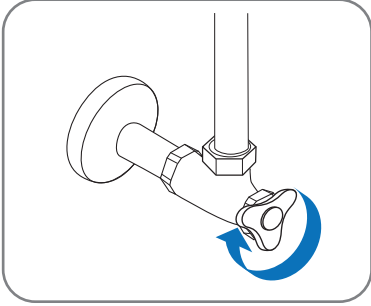

1. Close the water supply

Turn the water supply valve clockwise to close it.

Avoid water splashing before installing the product.

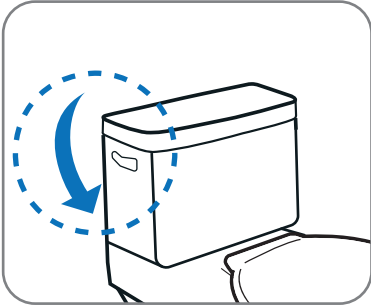

2. Empty the toilet tank

Press the lever to drain the water from the tank until it is completely empty.

It is not a problem even if there is a little water left before installing the product.



3. Disassembling the existing toilet seat

Unscrew the toilet seat fixing cap by flipping it upwards.

While unscrewing, hold the bolt on the underside of the screw with your other hand to secure the screw to loosen.

(Please follow the instruction of your toilet seat manufacturer if need assistance)

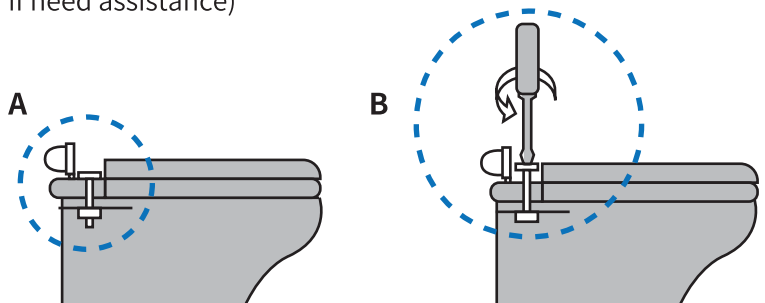

Installation Method

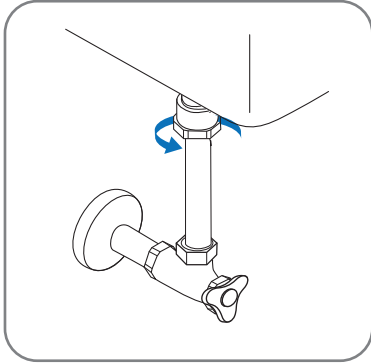

4. Water connection

Disconnect the toilet hose connected to the water supply valve.

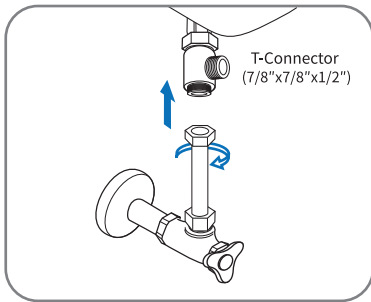

Connect the T-Connector to the water tank supply inlet.

Connect the T-Connector with the toilet hose.

Tightly connect the water supply valve, T-Connector, and toilet hose to prevent any leakage.

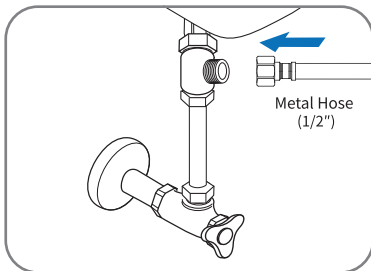

Combine Metal Hose and T-Connector.

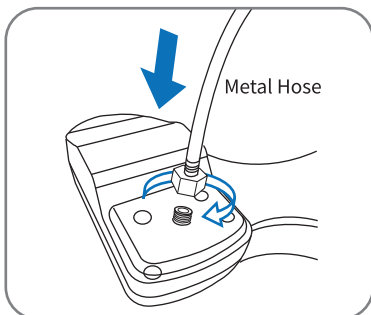

5. Finish the connection

Attach to the Metal Hose connector to the product.

Tightly connect the product and the Metal Hose so that there is no leakage.

Installation Method

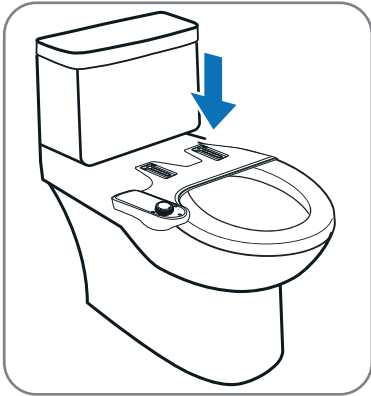

6. Attached to the toilet

After placing the product on the toilet, adjust the position of the product up/down and left/right.

Make sure the nozzle is centered.

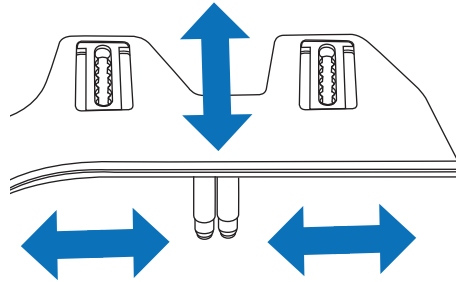

Put the toilet seat on top of the product and reassemble it.

Check again that the product does not move or fall out.

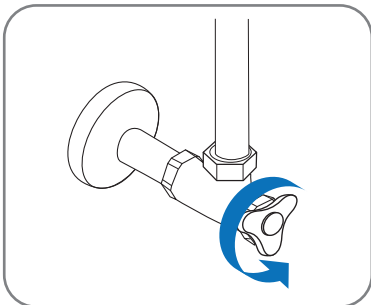
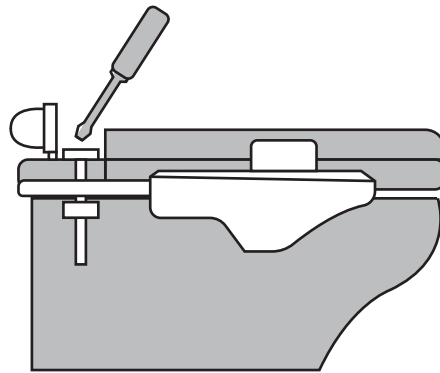

7. Open the water supply

Turn the water supply valve counterclockwise to open it.

※ Please check on each connection that make sure there are no water leakage.

How to use

ENGLISH

3. VM-001D / VM-001S

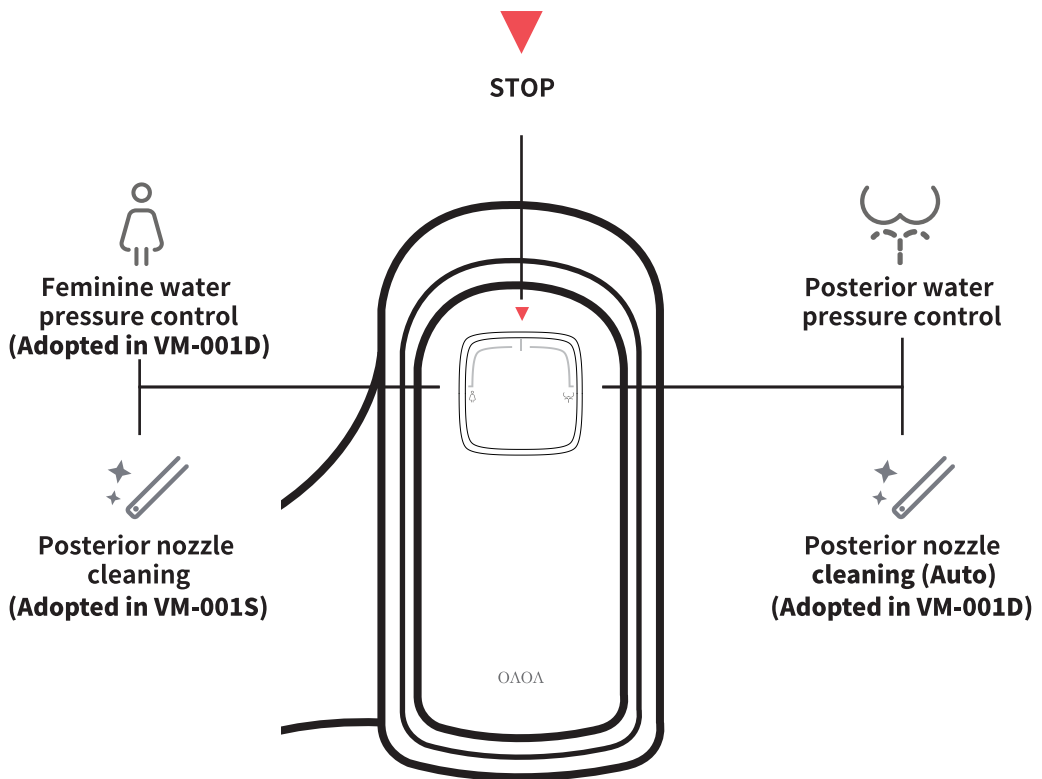

Feminine water pressure control (Adopted in VM-001D)

The water pressure will be increased by turning the knob counterclockwise.



Posterior water pressure control

The water pressure will be increased by turning the knob clockwise.



Posterior nozzle cleaning (Adopted in VM-001D)

The nozzle will clean itself automatically while using the 'Posterior wash'.



Posterior nozzle cleaning (Adopted in VM-001S)

The nozzle will clean itself by turning the knob counterclockwise.

- After washing gently at first and gradually adjust the strength, remove the remaining water with a little toilet paper or towel. Because the water pressure can be easily adjustable during use, you can also experience the massage effect by quickly adjusting the intensity
- Use your function to your preference.
- If you rotate the posterior water pressure control slowly from 'low → high', the nozzle will be drawn out and water will be sprayed.
- If you rotate the feminine water pressure control slowly from 'low → high', the nozzle will be drawn out and water will be sprayed.
- After each function, return the water pressure control to its original position.

Mode d'emploi

FRENCH

3. VM-001D / VM-001S

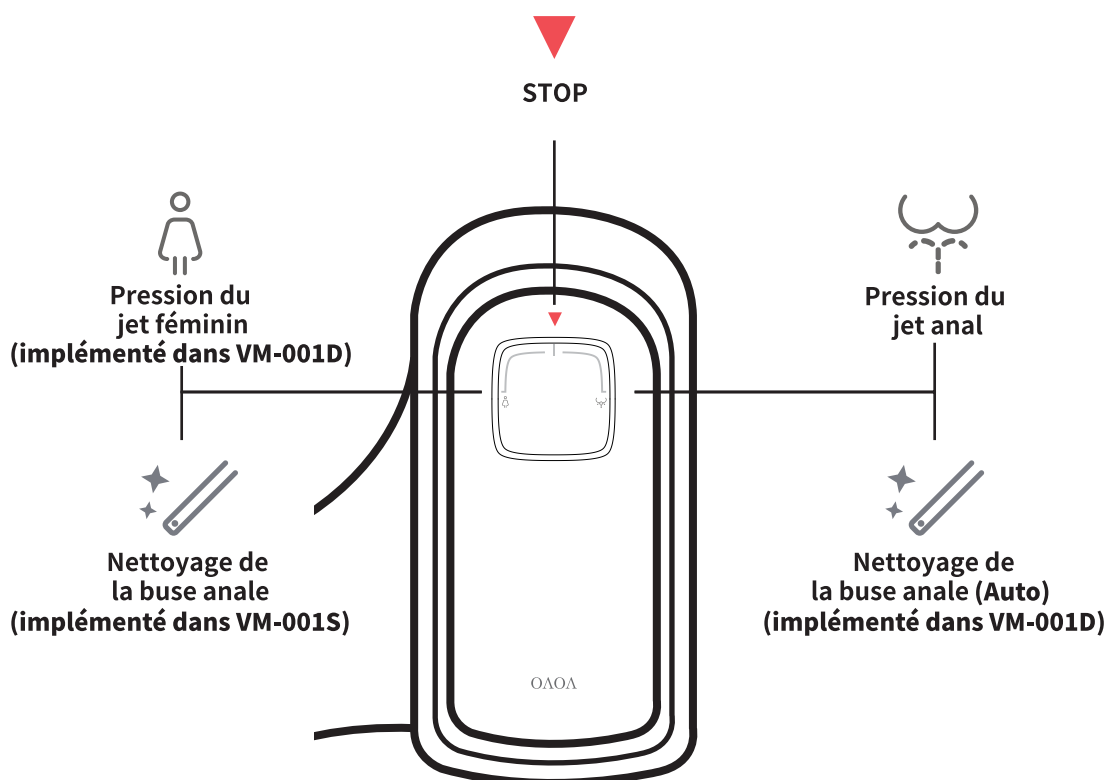

Pression du jet féminin (implémenté dans VM-001D)

La pression de l'eau sera augmentée en tournant le bouton dans le sens antihoraire.



Pression du jet anal

La pression de l'eau sera augmentée en tournant le bouton dans le sens des aiguilles d'une montre.



Nettoyage de la buse anale (implémenté dans VM-001D)

La buse se nettoie automatiquement lors de l'utilisation du jet anal.



Nettoyage de la buse anale (implémenté dans VM-001S)

La buse se nettoie d'elle-même en tournant le bouton dans le sens antihoraire.

- Commencez par utiliser une pression faible, puis ajustez peu à peu son niveau plus fort. Desséchez avec un peu de papier toilette ou une serviette après l'usage. Avec le réglage facile de la pression du jet d'eau pendant l'usage et sa rapidité, vous profiterez d'un lavage et d'un massage à la fois sanitaire et efficace.
- Après avoir fait vos besoins, choisissez le mode qu'il vous faut.
- Tournez lentement le bouton du réglage de la pression du jet anal de faible à fort. La buse se retire et le jet commence.
- Tournez lentement le bouton du réglage de la pression du jet féminin de faible à fort. La buse se retire et le jet commence.
- Après le lavage, retournez le bouton du réglage de la pression du jet à sa place initiale.

3. VM-001D / VM-001S

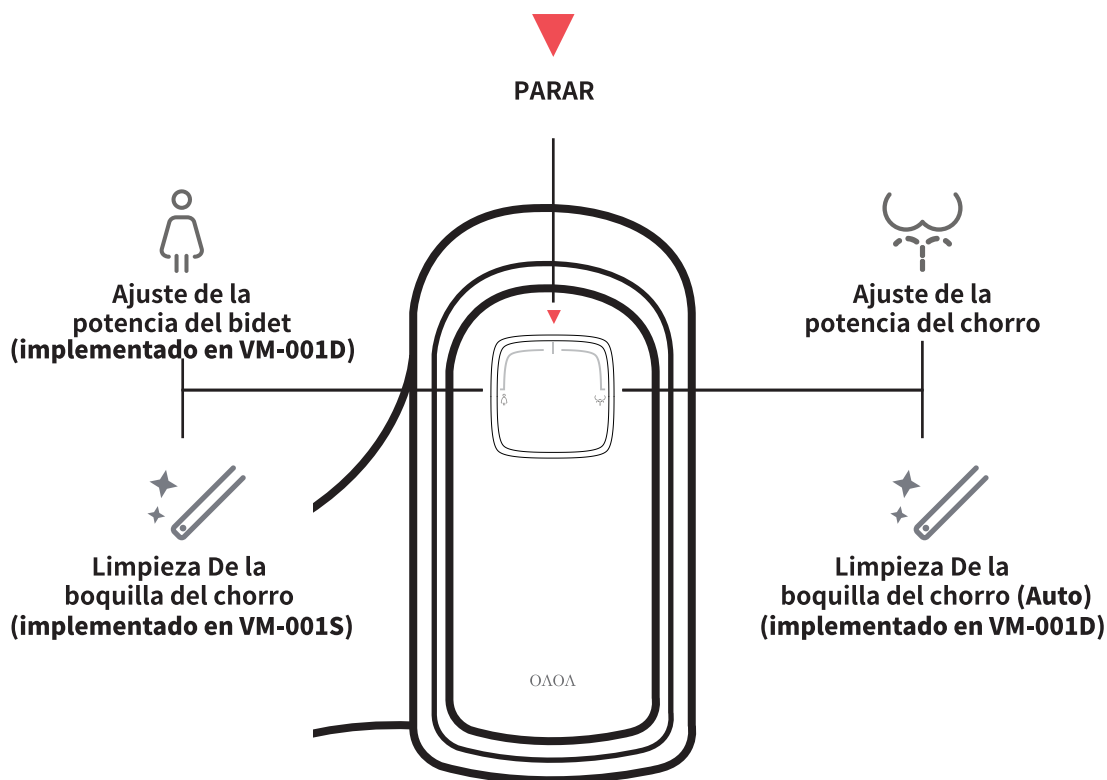

Ajuste de la potencia del bidet (implementado en VM-001D)

La presión del agua aumentará girando la perilla en sentido antihorario.



Ajuste de la potencia del chorro

La presión del agua aumentará girando la perilla en el sentido de las agujas del reloj.



Limpieza de la boquilla del chorro (implementado en VM-001D)

La boquilla se limpia automáticamente cuando se usa potencia del chorro.



Limpieza de la boquilla del chorro (implementado en VM-001S)

La boquilla se limpia sola girando la perilla en sentido antihorario.

- Límpiase gradualmente ajustando la potencia y séquese la humedad con papel o una toalla.
El ajuste de la potencia ofrece no sólo la función de la limpieza sino también el efecto de masaje.
- Después de hacer sus necesidades, seleccione la función.
- Al girar la manilla para aumentar la potencia de chorro gradualmente, se iniciará la limpieza.
- Al girar la manilla para aumentar la potencia del bidet gradualmente, se iniciará la limpieza.
- Al cabo de la limpieza, gire la manilla a su posición original para desactivar la función.

3. VM-001D / VM-001S

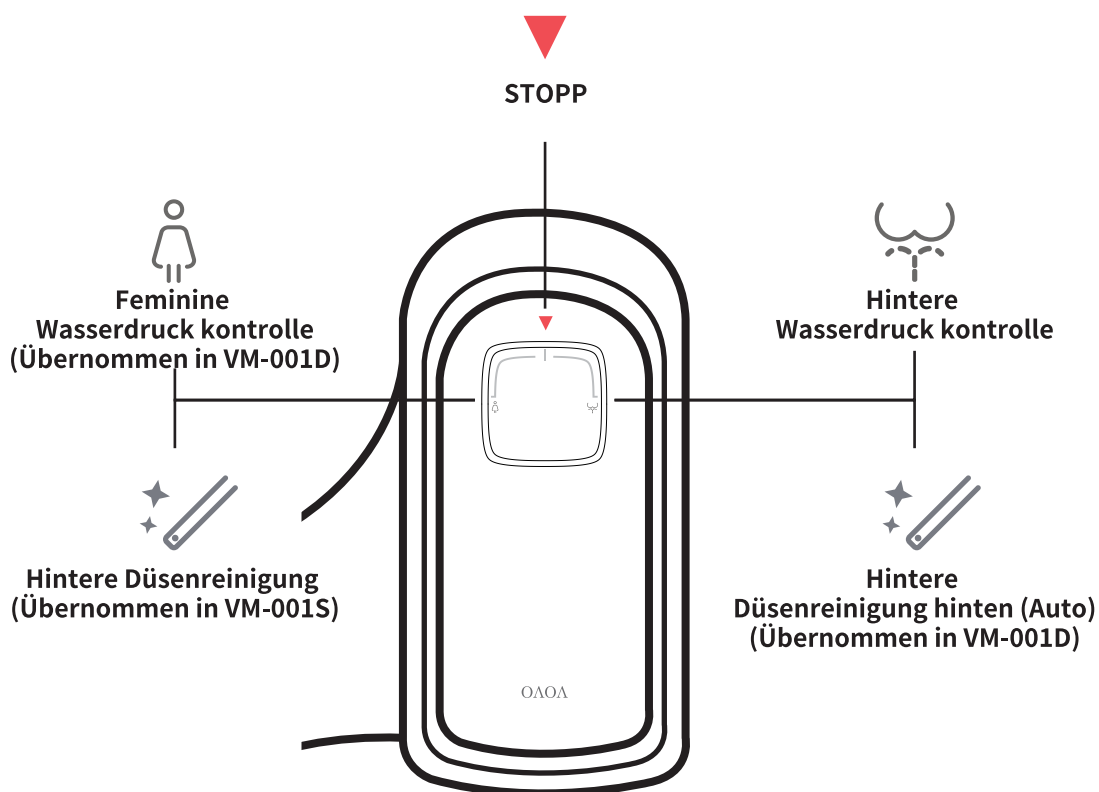

Feminine Wasserdruck kontrolle (Übernommen in VM-001D)

Der Wasserdruck wird durch Drehen des Reglers gegen den Uhrzeigersinn erhöht

Hintere Wasserdruck kontrolle

Der Wasserdruck wird erhöht, indem der Regler im Uhrzeigersinn gedreht wird.

Hintere Düsenreinigung (Übernommen in VM-001S)

Die Düse reinigt sich automatisch, wenn Sie die Funktion 'Posterior Wash' verwenden.

Hintere Düsenreinigung (Übernommen in VM-001S)

Die Düse reinigt sich selbst, indem Sie den Regler gegen den Uhrzeigersinn drehen.

- Nachdem Sie zunächst sanft gewaschen und die Stärke schrittweise eingestellt haben, entfernen Sie das restliche Wasser mit etwas Toilettenpapier oder einem Handtuch. Da der Wasserdruck während der Verwendung leicht eingestellt werden kann, können Sie auch den Massageeffekt erleben, indem Sie die Intensität schnell anpassen
- Verwenden Sie die Funktion nach Ihren Bedürfnissen.
- Wenn Sie den hinteren Wasserdruckregler langsam von 'niedrig -> hoch' drehen, wird die Düse herausgezogen und Wasser vermittelt.
- Wenn Sie den weiblichen Wasserdruckregler langsam von 'niedrig -> hoch' drehen, wird die Düse herausgezogen und Wasser versprüht.
- Stellen Sie den Wasserdruckregler nach jeder Funktion wieder in seine Ausgangsposition zurück.

3. VM-001D / VM-001S

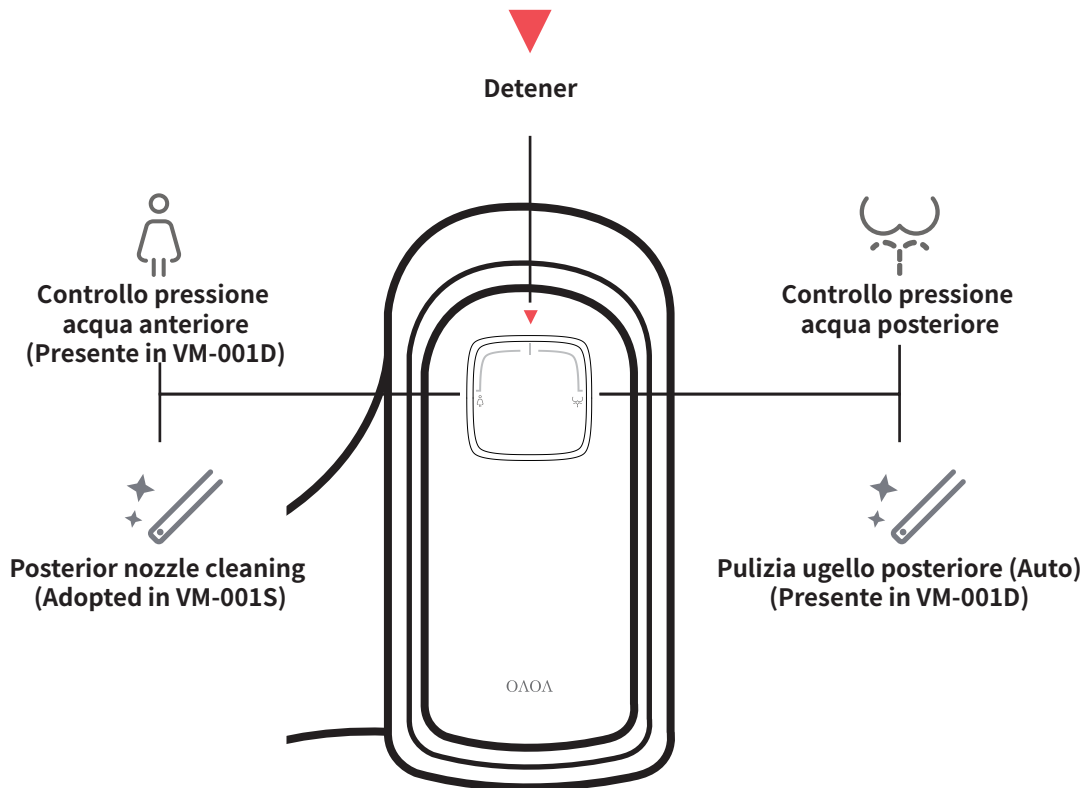

Controllo pressione acqua anteriore (Presente in VM-001D)

La pressione dell'acqua aumenta ruotando la manopola in senso antiorario.



Controllo pressione acqua posteriore

La pressione dell'acqua aumenta ruotando la manopola in senso orario.



Pulizia ugello posteriore (Adopted in VM-001D)

The nozzle will clean itself automatically while using the 'Posterior wash'.



Pulizia ugello posteriore (Presente in VM-001s)

L'ugello si pulirà da solo, ruotando la manopola in senso antiorario.

- Iniziare lavando delicatamente e gradualmente regolare l'intensità, rimuovere l'acqua rimanente con un po' di carta igienica o un asciugamano. La pressione dell'acqua può essere facilmente e rapidamente regolata durante l'uso ed è quindi possibile avere un effetto massaggiante cambiando l'intensità.
- Utilizza le funzioni a secondo delle tue esigenze.
- Ruotando lentamente il controllo della pressione dell'acqua posteriore per aumentare l'intensità, l'ugello verrà portato verso l'esterno e l'acqua verrà spruzzata.
- Ruotando lentamente il controllo della pressione dell'acqua anteriore per aumentare l'intensità, l'ugello verrà portato verso l'esterno e l'acqua verrà spruzzata.
- Dopo ogni utilizzo, riportare il controllo della pressione dell'acqua alla posizione di partenza.

Product Specification

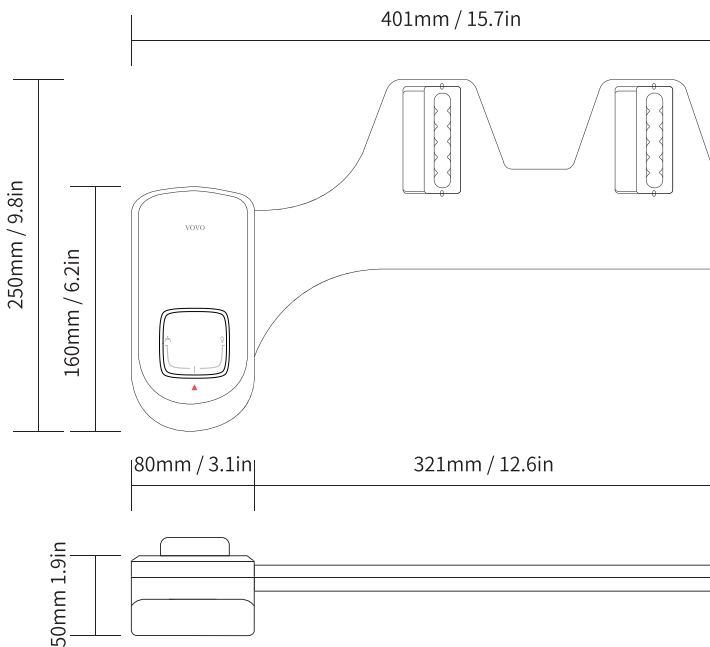

Size

Product	401x250x50(mm)
	15.7x9.8x1.9(in)
Package	440x200x75(mm)
	17.3x7.8x2.9(in)

Weight

N.W	448g / 0.9lb
G.W	906g / 1.9lb

※ Usable Water Pressure Range

12.80 - 99.56 psi

0.9-7.0 kgf/cm²

Product Maintenance

Symptom	Troubleshooting Guide
When there is a leak after installation.	- Recheck whether the product is installed correctly, and in case of water leakage from the product, contact the place of purchase.
When wash function is not working after installation	- Check whether the water valve is open or closed.
When water pressure is weak	- Check the water pressure by opening the water valve fully.
When the adapter(connection) size does not match	- Some imported piping materials may not conform to the standard, so please contact the place of purchase.
When cleaning the body.	- Apply a mild detergent to a soft cloth and wipe it off. - Do not use thinner, benzene, or polish.
When no water comes out	- Check if there is water outage. - Check whether the water valve is open or closed. - Check that there are no foreign substances caught in the mesh. - Check if the nozzle is clogged with foreign substances.

Limited Warranty

The product is warranted for one year according to the description written in this warranty.

Please submit the below form online at www.vovo-us.com.

Model :		Serial Number :	
Purchaser			
Company :			
Address :			
City :		Country :	
Phone :	Fax :	E-mail :	
Dealer (Company)			
Address :			
Installation Date :		Warranty period	
		1 year from purchase date	

Complete the above warranty card when purchasing the product.
Check the information and keep it safe.

This warranty does not apply to the following

1. Defects and/or malfunctions from failure to properly install, operate and/or maintain the unit in accordance with the installation manual.
2. Damage from abuse, fire, flood, freeze, electrical surges, lightning strikes or any other acts of nature.
3. Damage resulting from unauthorized alterations, attachments and/or repairs.
4. If the product was not installed properly for residential use.
5. Damage from installing the unit in an environment with animals, mice or insects.
6. Damage caused by excess moisture or from water clogging the water closet.
7. Damage from not being installed in accordance with all applicable local codes, ordinances and good trade practices.
8. Color fading due to use in wrong environment.
9. Damage from consumable chemicals.
10. The warrant will be covered only when providing the date of purchase with original receipt.
11. Damage from misuse due to not following the installation manual.

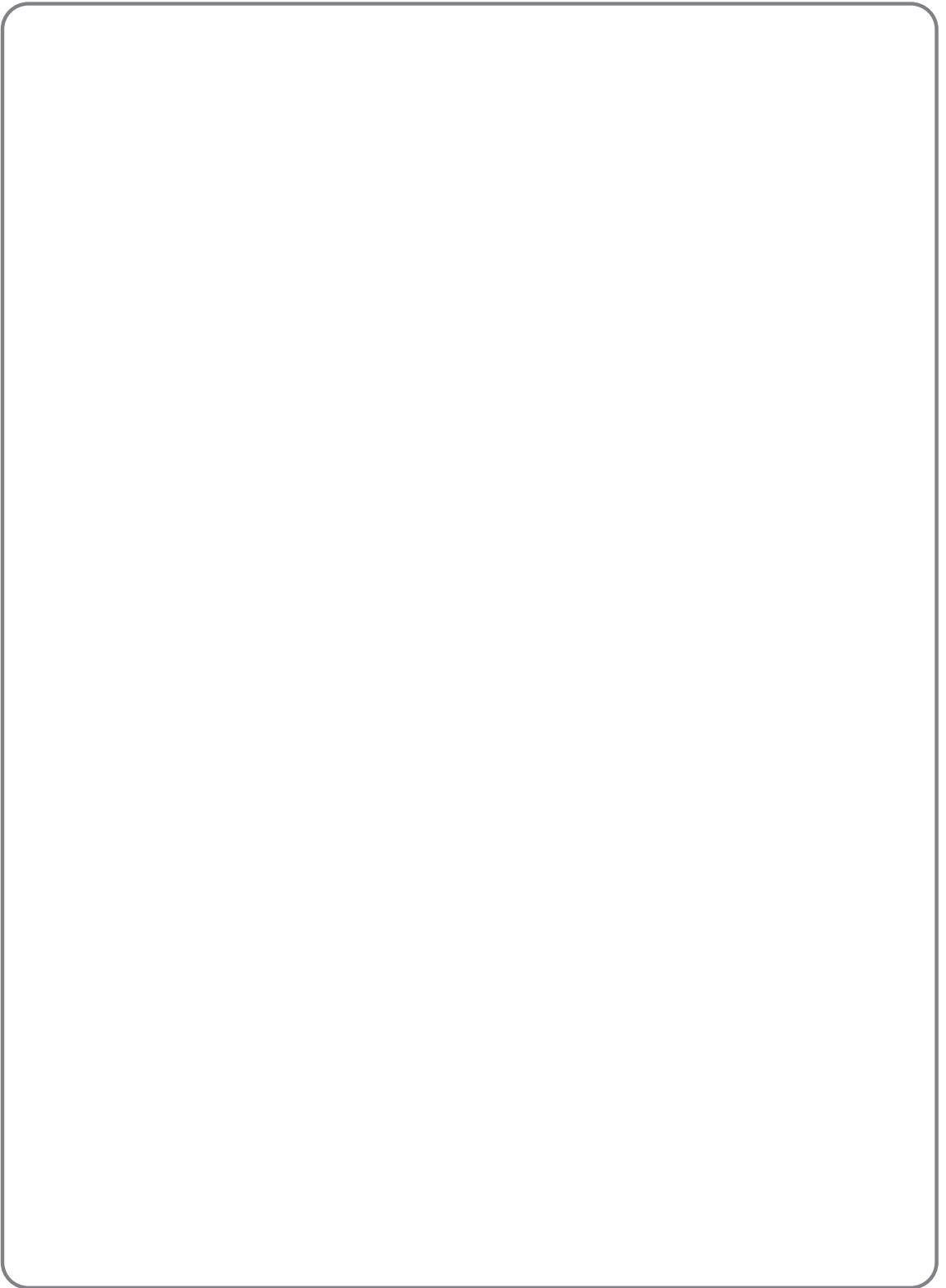

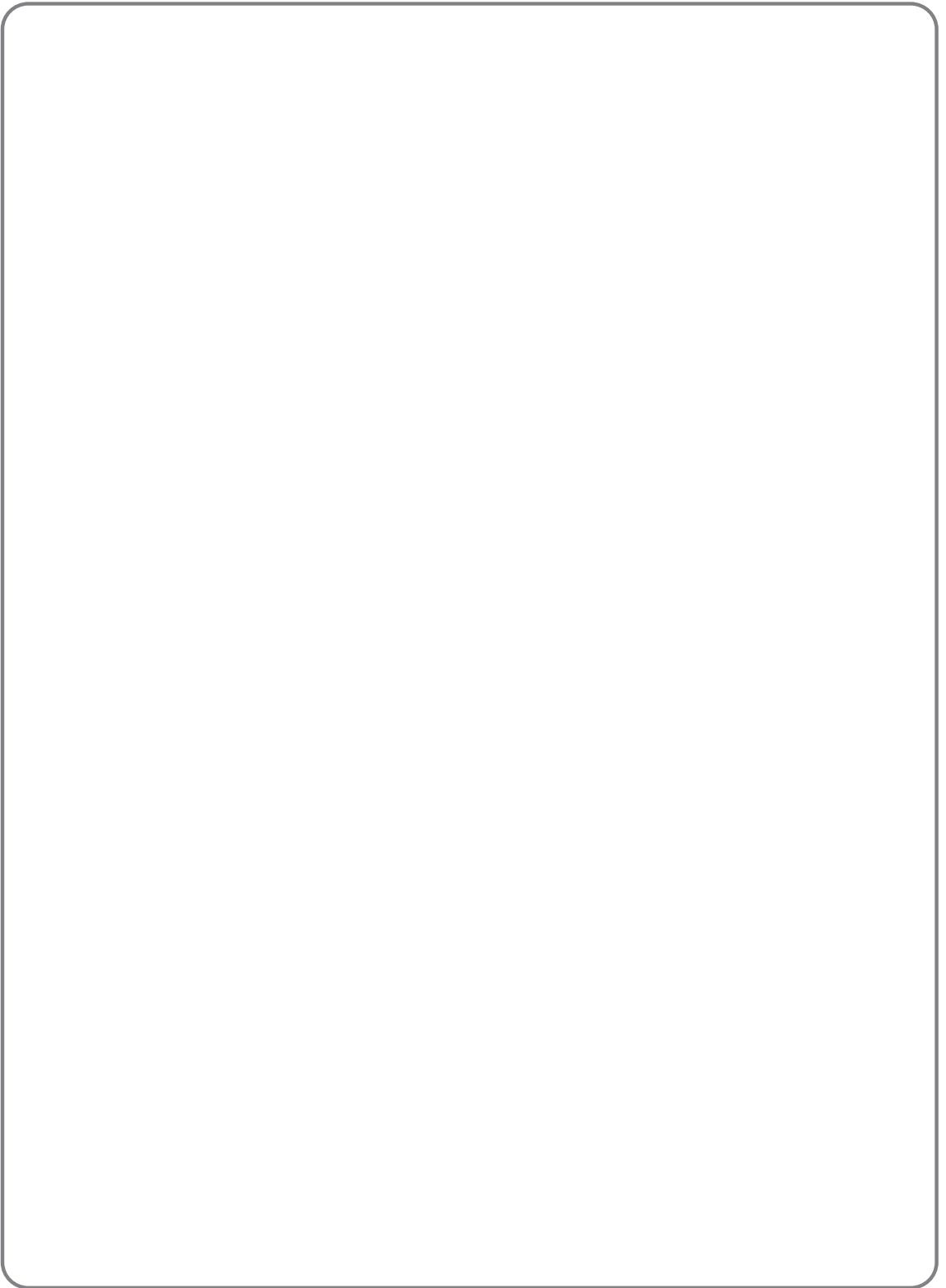



VOVO USA

377 Van Ness Ave Suite 1205-1206, Torrance, CA 90501
If you have any questions, please contact us through live chat at www.vovo-us.com or send us an email at support@imunsen.com

VOVO EU

E-mail : www.vovo-eu.com or
send us an email at support@vovoeu.com
Customer Support
E-mail : support@imunsen.com