

Trademarks

Autel®, MaxiSys®, MaxiDAS®, MaxiScan®, MaxiCheck®, and MaxiRecorder® are trademarks of Autel Intelligent Technology Corp., Ltd., registered in China, the United States and other countries. All other marks are trademarks or registered trademarks of their respective holders.

Copyright Information

No part of this manual may be reproduced, stored in a retrieval system or transmitted, in any form or by any means, electronic, mechanical, photocopying, recording, or otherwise without the prior written permission of Autel.

Disclaimer of Warranties and Limitation of Liabilities

All information, specifications and illustrations in this manual are based on the latest information available at the time of printing.

Autel reserves the right to make changes at any time without notice. While information of this manual has been carefully checked for accuracy, no guarantee is given for the completeness and correctness of the contents, including but not limited to the product specifications, functions, and illustrations.

Autel will not be liable for any direct, special, incidental, indirect damages or any economic consequential damages (including the loss of profits).

IMPORTANT

Before operating or maintaining this unit, please read this manual carefully, paying extra attention to the safety warnings and precautions.

For Services and Support:

Web: evcharging.autel.com

Tel: +49 (0) 89 540299608 (Europe)

0086-755-2267-2493 (China)

Email: support.eu@autel.com

For technical assistance in all other markets, please contact your local selling agent.

Safety Information

For your own safety and the safety of others, and to prevent damage to the device and vehicles upon which it is used, it is important that the safety instructions presented throughout this manual be read and understood by all persons operating or coming into contact with the device.

Safety Messages

Safety messages are provided to help prevent personal injury and equipment damage. All safety messages are introduced by a single word indicating the hazard level.

DANGER

Indicates an imminently hazardous situation which, if not avoided, will result in death or serious injury to the operator or to bystanders.

WARNING

Indicates a potentially hazardous situation which, if not avoided, could result in death or serious injury to the operator or to bystanders.

Safety Instructions

The safety messages herein cover situations Autel is aware of. Autel cannot know, evaluate or advise you as to all of the possible hazards. You must be certain that any condition or service procedure encountered does not jeopardize your personal safety.

SAFETY WARNINGS

- Read all the instructions before you use this device.
- Do not install or use the device near flammable, explosive, harsh, or combustible materials, chemicals, or vapors.
- Turn off power at the circuit breaker before installing or cleaning the device.
- This device should be supervised when used around children.

- This device must be grounded through a permanent wiring system or an equipment-grounding conductor.
- Use the device only within the specified operating parameters.
- Do not use the device if it is defective, appears cracked, frayed, broken or otherwise damaged, or fails to operate.
- Do not use the device if the flexible power cord or EV cable is frayed, broken, or otherwise damaged, or if it fails to operate.
- Do not attempt to disassemble, repair, tamper with or modify the device.
- Handle the device with care during transportation. Do not subject it to strong force or impact, pull, twist, tangle, drag or step on the device, to prevent damage to it and any of its components.
- Do not insert fingers or foreign objects into any part of the device.

CAUTION

- Do not use private power generators as a power source for charging.
- Incorrect installation and testing of the device could potentially damage the vehicle's battery, components, and/or the device itself.
- Do not operate the device in temperatures outside its operating range.

CONTENTS

SAFETY INFORMATION	ii
SAFETY MESSAGES	ii
SAFETY INSTRUCTIONS	ii
1 USING THIS MANUAL	1
CONVENTIONS	1
2 GENERAL INTRODUCTION	3
2.1 PRODUCT OVERVIEW	4
2.2 OPTIONS	7
2.3 SPECIFICATIONS	9
3 AUTEL CHARGE APP	11
3.1 GENERAL PROCEDURES	11
3.2 CHARGE SCREEN	13
3.3 BATTERY SCREEN	14
3.4 ME SCREEN	17
4 OPERATION	22
4.1 ENERGIZE THE CHARGER	22
4.2 START CHARGING	22
4.3 STOP CHARGING	23
5 TROUBLESHOOTING AND SERVICE	25
5.1 TROUBLESHOOTING TABLE	25
5.2 SERVICE	28
6 COMPLIANCE INFORMATION	29
7 WARRANTY	30

1 Using This Manual

This manual contains device usage instructions.

Some illustrations shown in this manual may contain modules and optional equipment that are not included in your system. Contact your sales representative for availability of other modules and optional tools or accessories.

Conventions

The following conventions are used.

Bold Text

Bold text is used to highlight selectable items such as buttons and menu options.

Example:

- Tap **OK**.

Notes and Important Messages

Notes

A **NOTE** provides helpful information such as additional explanations, tips, and comments.

Example:

NOTE

The VIN description (such as location) can be acquired by tapping the question mark () beside the "VIN" or View VIN Guidelines on the Scan VIN screen.

Important

IMPORTANT indicates a situation which, if not avoided, may result in damage to the test equipment or vehicle.

Example:

! IMPORTANT

All contents of the product may be deleted during the process of repair. You should create a back-up copy of any contents of your product before delivering the product for warranty service.

Hyperlink

Hyperlinks or links that take you to other related articles, procedures, and illustrations are available in electronic documents.

Illustrations

Illustrations used in this manual are only examples; the actual product(s) or screens may vary.

2 General Introduction

The Autel Charger AC wallbox is designed to charge an electric vehicle (hereinafter called EV). Our chargers provide you with safe, reliable, fast, and smart charging solutions.

This manual will instruct you how to use this charger.

Intended Use

The Autel Charger is intended for the AC charging of EVs. It is intended for both indoor and outdoor use.

- Residential
- Commercial
- Workplace
- Vehicle Workshop

DANGER

1. If you use the equipment in any way other than described in this manual or other related documents, possible death, injury and damage to property can occur.
 2. Use the equipment only as intended.
-

NOTE

This manual is for both cable and socket chargers. The illustrations in this manual use the socket version as an example.

2.1 Product Overview

Autel Charger AC Wallbox

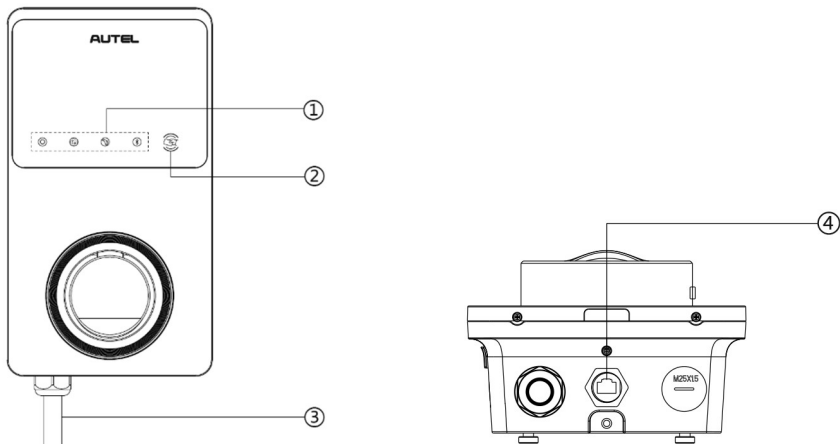

1. LED Indicators (from left to right):
 - Power LED
 - Internet Connection LED
 - Charging LED
 - Bluetooth Connection LED
2. RFID Reader
3. AC Input Cable
4. RJ45 Ethernet Port

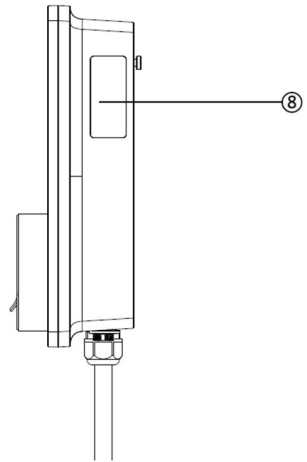
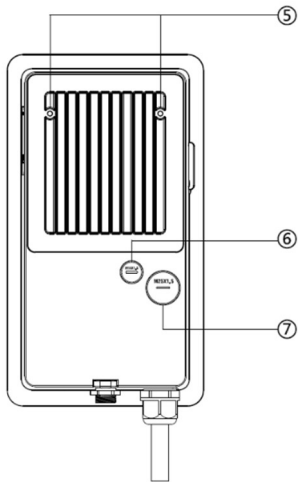

- 5. Mounting Screws
- 6. Rear Entry Signal Conduit Plug
- 7. Rear Entry Power Conduit Plug
- 8. Product Label

LED Description

LED	Description
Power LED	<ul style="list-style-type: none">● Solid Green: The Autel Charger is on.● Off: The Autel Charger is off.● Flashing Yellow: Data is being transmitted and/or firmware is upgrading.● Solid Yellow: Firmware upgrade has failed.● Solid Blue: Data transmission has failed; will turn solid green in five seconds (see above).
Internet Connection LED	<ul style="list-style-type: none">● Solid Green: The Autel Charger is connected to the Internet via Wi-Fi, LAN or cellular network.● Off: The Autel Charger is not connected to the Internet.
Charging LED	<ul style="list-style-type: none">● Solid Blue: An EV is connected.● Flashing Blue: An EV is charging as scheduled.● Flashing Cyan: The charger is reserved.● Flashing Green: An EV is charging.● Solid Orange: A recoverable error has occurred.● Solid Green: An EV is fully charged.● Off: No EV connected.● Solid Red: An irrecoverable error has occurred. (Please contact support.)
Bluetooth Connection LED	<ul style="list-style-type: none">● Flashing Green: The Autel Charger is connected to a mobile device via Bluetooth.● Flashing Blue: The Autel Charger is connected to VCI (Vehicle Communication Interface) via Bluetooth.● Flashing Cyan: The Autel Charger is connected to a mobile device and a VCI device simultaneously via Bluetooth.● Off: The Autel Charger is not connected via Bluetooth.

2.2 Optional

Display

- A. Ambient Light Sensor — detects ambient brightness
- B. Display
- C. Energy Pulse Output (Infrared Ray)

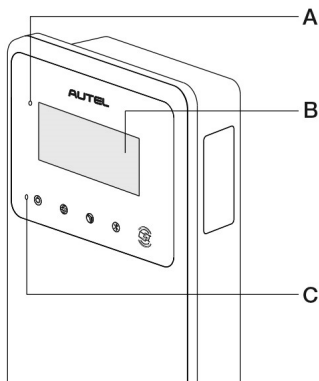

D. SIM Card Socket

(Available on chargers with 4G function.)

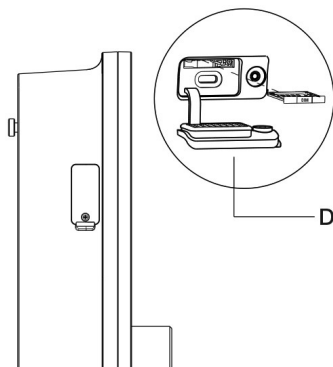

Cable Model

- E. Charging Handle Safety Lock — **Press to release charging handle from its cradle**
- F. Charging Handle, Type 2
- G. Cradle
- H. EV Charge Cable

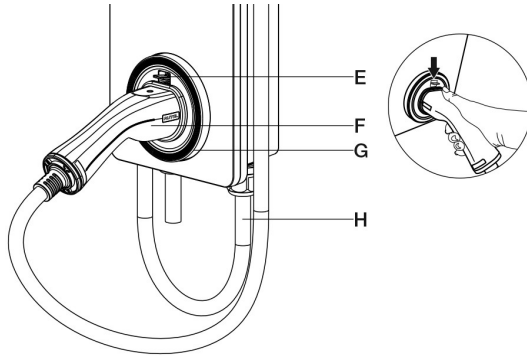

Socket Model

- I. Socket, Type 2

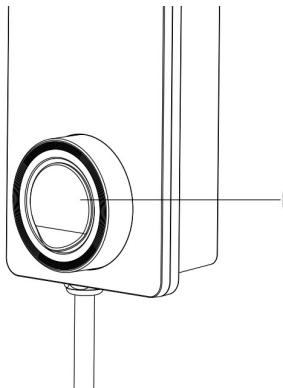

2.3 Specifications

	Item	Description
Product Information	Charging Type	Mode 3 charging
	Input/Output Power Rating and Current	Single-phase up to 7.4 kW/32 A Three-phase up to 22 kW/32 A
	Protection	Over-current, over-voltage, under-voltage, ground fault including DC residual current protection, integrated surge protection
	Input/Output Voltage	230 V \pm 15%, single phase 400 V \pm 15%, three phase 50 Hz
	Network Type	TT, TN
General Characteristics	IP and IK Rating	Cable model: IP65; IK08 Socket model: IP54; IK08
	Operating Altitude	2,000 m
	Operating Temperature Range	-40 °C to + 55 °C
	Storage Temperature Range	-40 °C to + 85 °C
	Mounting	Wall or floor using a pedestal
	Dimensions (H x W x D)	Cable: 336 x 187 x 85 mm Socket: 336 x 187 x 115 mm

	Item	Description
User Interface	Status Indication	LED App
	User Interface	Autel Charge app
	Connectivity	<ul style="list-style-type: none"> ● 4G ● Bluetooth ● Wi-Fi ● Ethernet
	Communications Protocols	OCPP 1.6J
	User Authentication	<ul style="list-style-type: none"> ● App ● RFID card ● QR code
Software Update	Software Update	<ul style="list-style-type: none"> ● OCPP 1.6J ● App ● Web portal
Certifications and Standards	Safety Standards	IEC/EN 61851-1, EN 62311, EN 62479, IEC/EN 62955
	Certifications	CE, TUV
	Warranty	36 months

3 Autel Charge App

The Autel Charge app allows you to track, manage, and optimize EV charging at your location. With our app, you are able to start, stop, and schedule charging remotely and track your EV battery health while charging.

3.1 General Procedures

1. Download the App

The Autel Charge app is available for both iOS and Android mobile devices. For iOS users, download the app on the Apple App Store; for Android users, download on the Google Play Store.

2. Log in

Open the Autel Charge app on your mobile device, and log in with your phone number or email. If you do not have an account already, register with your phone number first.

3. Bind the Charger

To bind the charger, simply scan the QR code on the [Quick Reference Guide](#).

4. Connect the Charger

Bind the charger first before connecting it on the app. You can use any of the following ways to connect your charger:

- a) Via Bluetooth.
- b) Via Wi-Fi, cellular or LAN network.

5. Start Charging

Tap **Start** on the Charge screen to start a charge session. The Charge screen will display.

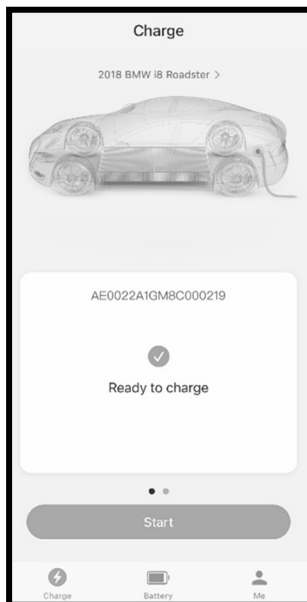

Figure 3-1 Sample Charge Screen 1

6. **Stop Charging**

Tap **Stop** on the Charge screen to end a charge session (see Figure 3-2).

NOTE

1. Make sure the Wi-Fi or Bluetooth is enabled on your mobile device in order to properly connect the charger.
 2. The charge cards in the package are bound to the charger by default.
 3. If the power supply is suddenly interrupted, the charger will not be cut off immediately, and the data can be saved on it.
 4. We recommend you reinsert the EV charge cable if you want to restart a charge session as some vehicle manufacturers have restrictions on the restarting.
-

3.2 Charge Screen

Once your EV starts charging, the Charge screen will show.

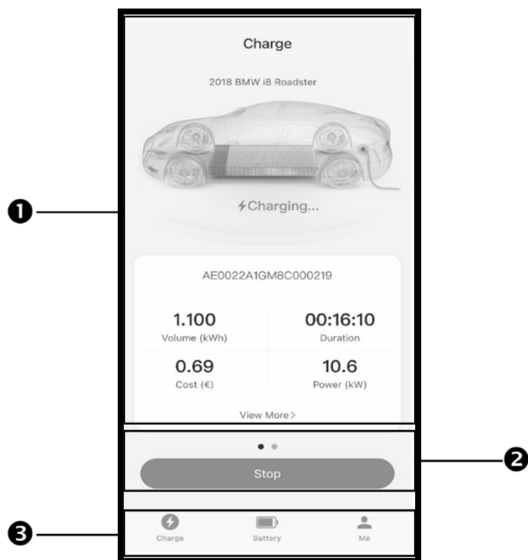

Figure 3-2 Sample Charge Screen 2

1. Charging Information
2. Function Buttons
3. Navigation Bar

Charging Information

Charging information is available on the screen. Your EV model and the charging status will be displayed on the top of the screen.

In the middle of screen displays the serial number and other information such as energy, duration, cost, and power.

Tap **View More** to check the electrical current and voltage values, as well as the power chart. Two buttons are available on this screen:

- **Cancel:** Tap to go back to the previous screen.
- **Settings:** Tap to go to the Settings screen (also the My Charger screen).

Function Buttons

Button	Description
Start	Tap to start a charge session.
Stop	Tap to stop a charge session.

Navigation Bar

The navigation bar consists of three options:

- **Charge:** Tap to enter the main Charge screen and view charging information.
- **Battery:** Tap to enter the main Battery screen, where you can check and edit your vehicle and battery information.
- **Me:** Tap to access My Charger, Charge History, Settings, and About information.

3.3 Battery Screen

A list of EVs that have been connected to the charger will display on the Battery screen. The top of the list is the default EV that is to be charged. VIN and battery information for each EV can be viewed.

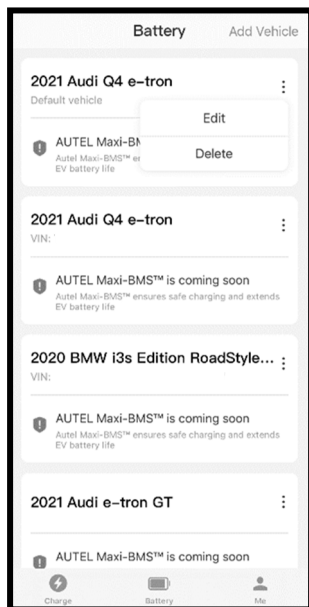





Figure 3-3 Sample Battery Screen

To edit or delete the EV, tap the  button to the right of the EV model. The editable information includes license number, VIN, make, model, and year of the EV. Tap **Save** to save the changes or the  button to exit without saving.

To add a new EV for charging, tap **Add Vehicle** on the top-right corner of the screen and fill in the information as required. Make, model, and model year are compulsory information.

You can input the VIN manually or scan VIN automatically by tapping the  button to the right of the VIN input field.

 **NOTE**

The VIN description (such as location) can be acquired by tapping the question mark () beside the "VIN" or **View VIN Guidelines** button on the Scan VIN screen.

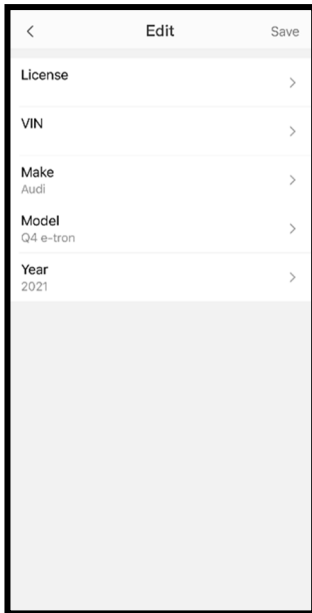

Figure 3-4 Sample Add Vehicle Screen

3.4 Me Screen

The Me screen allows you the direct access to My Charger, Charge History, Settings, and About screens.

Messages will display on the top-right corner of the screen.

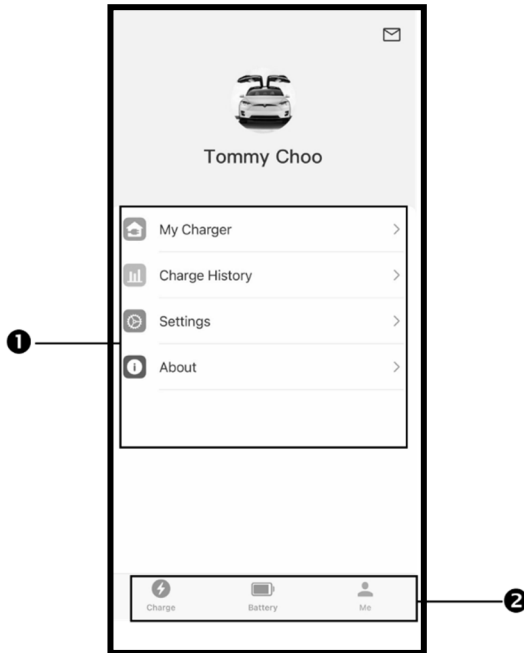

Figure 3-5 Sample Me Screen

1. Main Menu
2. Navigation Bar

3.4.1 My Charger

On the My Charger screen, you will be able to check basic information retaining to the charger, change charging and other settings, and bind to the charger via the **Add** button on the top-right corner of the screen.

The basic information demonstrates the current connection status and allows you to set up a name for your charger, acquire your current charging location, check Wi-Fi connection, and manage your charge cards. You can add a new charge card by either entering/scanning the card number or by holding the card close to the RFID reader.

For charge settings, you can set the charge current limit (6-32 A) and price, schedule you charging hours, and enable/disable the Plug-and-charge function.

On the My Charger screen, you can also access firmware updates, reboot the charger, and add Siri functionality (only for iOS users).

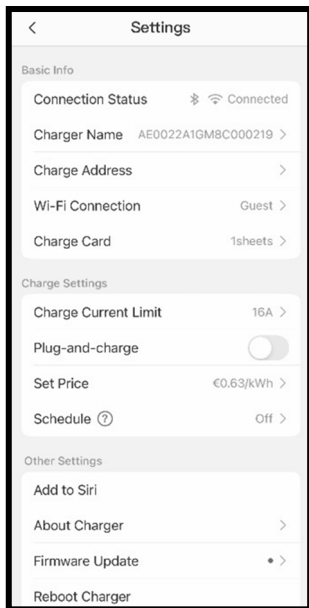

Figure 3-6 Sample My Charger Screen

In order to check whether the residual current device works properly, the user can tap the **Test** button on the screen, which prompts the charger to simulate a leakage situation. If the device works properly, the power supply to the charger will be cut off and the Charging LED on the charger will illuminate red. Plug and unplug the charging handle to correct the fault.

To start the test, go to *Me > My Charger > Installation Mode > Leakage Protection Device Test*.

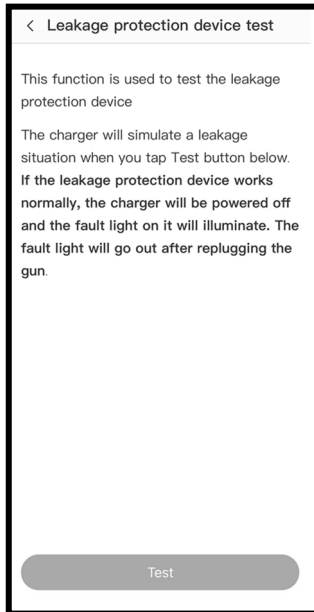

Figure 3-7 Sample Leakage Protection Device Test Screen

3.4.2 Charge History

Charge History records the total energy and cost of your past charges. You can choose to view the total energy or cost of a certain month. Daily energy, duration, and cost data are also available.

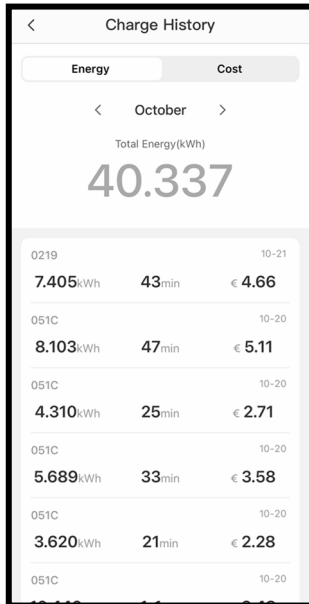

Figure 3-8 Sample Charge History Screen

3.4.3 Settings

On the Settings screen, you can change the settings for the Autel Charge app.

The settings allow you to enable/disable notifications such as Charging Interrupted and Firmware Update, change language and currency/distance units, clear the cache, and log out of your account.

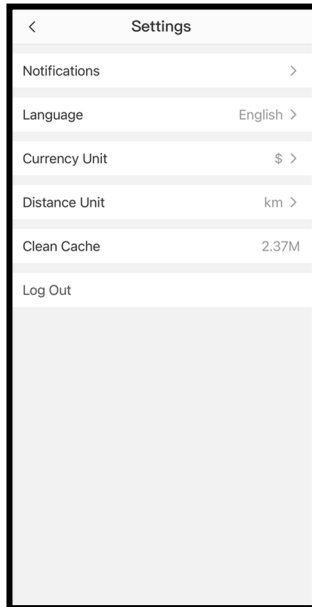

Figure 3-9 Sample Settings Screen

3.4.4 About

The About screen will show the software version(s) of the Autel Charge app.

4 Operation

4.1 Energize the Charger

Close the breaker that supplies the power to the charger, and wait for the power supply to come on. There will be a series of self-check starts, making sure that the charger works correctly and safely. If a recoverable error is detected, the charging LED illuminates orange; if the error cannot be recovered, it illuminates red.

Warning

Be careful when you work with electricity.

4.2 Start Charging

Caution

During the charge session, do not disconnect the charging handle. There is a risk of damage to the cradle of the charger or the connector of your EV.

4.2.1 Cable Models

1. Remove the charging handle from the cradle of the charger.
2. Insert the charging handle into the charge port on your EV.
3. Choose from the following four ways to start a charge session:
 - Tap your RFID card on the RFID reader.
 - Use the Autel Charge app by tapping **Start** on the Charge screen. See section 3.1.
 - If you have set a charging schedule in the Autel Charge app, the charger will initiate a charge session automatically as scheduled.
 - If the Plug-and-charge function is enabled in the Autel Charge app, the charger will automatically start charging once the charging handle is properly connected.

4.2.2 Socket Models

1. Insert your charging handle into the charge port on your EV and the charger socket outlet.
2. Choose from the following four ways to start a charge session:
 - Tap your RFID card on the RFID reader.
 - Use the Autel Charge app by tapping **Start** on the Charge screen. See section 3.1.
 - If you have set a charging schedule in the Autel Charge app, the charger will initiate a charge session automatically as scheduled. (Scheduled charging case.)
 - If the Plug-and-charge function is enabled in the Autel Charge app, the charger will automatically start charging once the charging handle is properly connected. (Plug-and-charge case.)

NOTE

Ensure your EV is charging. The charging LED on the charger should be flashing green. If you suspect the vehicle is not charging properly, try reconnecting the charge cable or contact the local dealer for support.

4.3 Stop Charging

NOTE

If you disconnect the EV charge cable during the charge session, the charger automatically disconnects the power supply. This stops all charging operations.

4.3.1 Cable Models

1. To stop charging, you can choose either of the following two ways:
 - Wait for the charge session to end and no further actions are required in the case of scheduled charging or plug-and-charge.
 - The charging LED will light solid green.
 - The Autel Charge app displays that your vehicle is fully charged.

- If the charger has a display, it will show that your vehicle is fully charged.

 **NOTE**

When your vehicle is fully charged, the charger will automatically disconnect the power supply.

- End the charge session by tapping your RFID card on the RFID reader again or via the Autel Charge app by tapping **Stop** on the Charge screen. See section 3.1.
2. Remove the charging handle from the vehicle charge port and return it to the cradle of the charger.

4.3.2 Socket Models

1. To stop charging, you can choose either of the following two ways:
 - Wait for the charge session to end and no further actions are required in the case of scheduled charging or plug-and-charge.
 - The charging LED will light solid green.
 - The Autel Charge app displays that your vehicle is fully charged.
 - If the charger has a display, it will show that your vehicle is fully charged.

 **NOTE**

When your vehicle is fully charged, the charger will automatically disconnect the power supply.

- End the charge session by tapping your RFID card on the RFID reader again or via the Autel Charge app.
2. Remove the charging handle from the charger socket outlet and the EV charge port.

5 Troubleshooting and Service

5.1 Troubleshooting Table

Item	Problems	Solutions
1	I do not need the 485 communications cables to the distribution box.	Use the electrical tape to coil the 485 communications cables respectively.
2	The charger is successfully bound, but the Bluetooth connection fails.	Check whether the QR code on the charger is consistent with the QR code on the Quick Reference Guide. If so, make sure the Bluetooth is enabled on your mobile device; if not, contact customer support.
3	The charge session does not start as scheduled.	The EV charge cable cannot be inserted into the EV charge port when scheduling the charge for the first time. Insert the EV charge cable after the schedule is set up.
4	The charge card is lost.	Go to <i>Me > My Charger > Charge Card</i> to delete your card to avoid fraudulent use. Five charge cards can be bound to your account at most.
5	Over-voltage	Use the multimeter to check whether the voltage on the power input is too high. If the result is above 0.01 V, contact local power grid company.

Item	Problems	Solutions
6	Under-voltage	Use the multimeter to check whether the voltage on the power input is not sufficient. If the result is below 0.01 V, contact local power grid company.
7	Missing phase	Check the wires in the distribution box. If two wires are connected together accidentally, separate the wires.
8	Inputs incorrectly wired: possibly Line and Neutral are inverted.	Correct the wiring.
9	Ground fault	Make sure the charger is earthed correctly.
10	Power failure	Make sure the switch to the circuit breaker is on.
11	Over-heating	<ul style="list-style-type: none"> ● Check whether the EV charge cable is securely connected. ● Ensure the operating temperature is within the specified range on the product label. ● Stop charging. Restart charging in half an hour.
12	Residual current detected	Unplug the vehicle and plug in again. If the problem persists, contact your local representative.
13	Abnormal pilot voltage	Unplug the vehicle and plug in again.
14	Contactor fault	Contact your local representative.

Item	Problems	Solutions
15	Over current	Unplug the vehicle and plug it again.
16	Pilot fault	Use an Autel diagnostics tool to scan fault, and contact the vehicle manufacturer to clear fault.
17	No Proximity Pilot (PP) connection or PP fault	<ul style="list-style-type: none"> ● Examine the connection of the EV charge cable. ● Ensure both EV charge cables are not broken or frayed. ● If the problem persists, contact your local representative.
18	E-lock failure	<ul style="list-style-type: none"> ● Examine the connection of the EV charge cable. ● If the problem persists, contact your local representative.
19	Power relay fault	Contact a qualified electrician.
20	Bluetooth module communication failure	Contact your local representative.
21	Update failure via Bluetooth	Contact your local representative.
22	Internet connection fails	Contact your local representative.
23	Home power system only supports single-phase. How to connect the power supply wiring?	Connect the L1, N, and PE wires to the charger's terminal block as specified. Wiring to the distribution box is the same.

5.2 Service

If you cannot find solutions to your problems with the aid from the table above, please contact our technical support.

AUTEL

- **Website:** evcharging.autel.com
- **Phone:** +49 (0) 89 540299608 (Monday-Friday, 9:00AM-6:00PM Berlin Time)
- **Email:** sales.eu@autel.com; support.eu@autel.com
- **Address:** Adalperostraße 82, 85737 Ismaning, Germany

6 Compliance Information

The product is in conformity with the following standards and/or other normative documents:

EN 301 489-1 V2.2.3

EN 301 489-3 V2.1.1

EN 301 489-17 V3.2.4

EN 301 489-52 V2.1.1

EN 300 328 V2.2.2

EN 300 330 V2.1.1

EN 301 908-1 V13.1.1

EN 301 908-2 V13.1.1

EN 301 908 -13 V13.1.1

EN 301 511 V12.5.1

EN 50663

EN 50665

BS EN IEC 61851-1

EN IEC 61851-1

IEC 61851-21-2

EN IEC 61851-21-2

7 Warranty

Limited Three Years Warranty

Autel Intelligent Technology Corp., Ltd. (the Company) warrants to the original retail purchaser of this equipment that should this product or any part thereof during normal usage and under normal conditions be proven defective in material or workmanship and results in product failure within three-year period from the date of purchase, such defect(s) will be repaired, or replaced (with new or rebuilt parts) with Proof of Purchase, at the Company's option, without charge for parts or labor directly related to the defect(s).

The Company shall not be liable for any incidental or consequential damages arising from the use, misuse, or mounting of the device. Some states do not allow limitation on how long an implied warranty lasts, so the above limitations may not apply to you.

This warranty does not apply to:

1. Products subjected to abnormal use or conditions, accident, mishandling, neglect, unauthorized alteration, misuse, improper installation or repair or improper storage;
2. Products whose mechanical serial number or electronic serial number has been removed, altered or defaced;
3. Damage from exposure to excessive temperatures or extreme environmental conditions;
4. Damage resulting from connection to, or use of any accessory or other product not approved or authorized by the Company;
5. Defects in appearance, cosmetic, decorative or structural items such as framing and non-operative parts;
6. Products damaged from external causes such as fire, dirt, sand, battery leakage, blown fuse, theft or improper usage of any electrical source.

! IMPORTANT

All contents of the product may be deleted during the process of repair. You should create a back-up copy of any contents of your product before delivering the product for warranty service.
